



MAX9792A Evaluation Kit

General Description

The MAX9792A evaluation kit (EV kit) demonstrates the MAX9792A IC, which combines a mono Class D power amplifier, a DirectDrive® stereo headphone amplifier, and a 120mA, 4.75V low-dropout regulator (LDO) for notebook, tablet PC, and portable media player applications. Maxim's DirectDrive technology eliminates the need for bulky DC-blocking capacitors at the output of the headphone amplifier.

The EV kit is configured for a 12dB speaker amplifier gain and a 0dB headphone amplifier gain. It is designed to operate from a 4.5V to 5.5V speaker supply and an optional separate 2.7V to 5.5V headphone supply. The EV kit is capable of delivering up to 3W into a 3Ω speaker and 180mW into a 32Ω headphone load.

Features

- ◆ No DC-Blocking Output Capacitors Required at Headphone Output
- ◆ Speaker and Headphone Operation
 - Speaker: 3W Mono Class D Output
 - Headphone: 180mW Stereo DirectDrive Output
- ◆ Wake-on-Beep Function
- ◆ 120mA, 4.75V LDO
- ◆ Lead(Pb)-Free and RoHS Compliant
- ◆ Fully Assembled and Tested

Ordering Information

PART	TYPE
MAX9792AEVKIT+	EV Kit

+Denotes lead(Pb)-free and RoHS compliant.

Component List

DESIGNATION	QTY	DESCRIPTION
REQUIRED COMPONENTS		
C1, C5, C6, C25–C28	7	1μF ±10%, 10V X7R ceramic capacitors (0603) Murata GRM188R71A105K
C3, C4, C29	3	1μF ±10%, 50V X7R ceramic capacitors (0805) Murata GRM21BR71H105K
C7, C8, C9	3	0.1μF ±10%, 16V X7R ceramic capacitors (0603) Murata GRM188R71C104K
C10, C30, C31	3	10μF ±10%, 10V X7R ceramic capacitors (0805) Murata GRM21BR71A106K
R1	1	20kΩ ±1% resistor (0603)
R3, R4, R13	3	40.2kΩ ±1% resistors (0603)
U1	1	Speaker and headphone amplifiers with LDO (28 TQFN-EP*) Maxim MAX9792AETI+
—	1	PCB: MAX9792A Evaluation Kit+

*EP = Exposed pad.

DirectDrive is a registered trademark of Maxim Integrated Products, Inc.

DESIGNATION	QTY	DESCRIPTION
OPTIONAL COMPONENTS		
AVDD, HPVDD, PGND, SPOUT+, SPOUT-	5	Binding posts
C13, C14, C19, C20, C23, C24, C33	0	Not installed, ceramic capacitors (0603)
C16	0	Not installed, ceramic capacitor (0805)
HPINL	1	White side-entry phono jack
HPINR, SPIN	2	Red side-entry phono jacks
HPL, HPR, PGND, SENSE, SPO+, SPO-	0	Not installed, small PCB test points
HPOUT	1	3.5mm stereo headphone jack
JU1, JU2, JU3	3	3-pin headers
JU4, JU5	2	2-pin headers
L3, L4	0	Not installed, inductors (6.4mm x 6mm x 1.5mm)
R7, R8	2	0Ω ±5% resistors (0805)
R11, R12, R15	0	Not installed, resistors (0603)
—	5	Shunts (JU1–JU5)

Evaluates: MAX9792A



Maxim Integrated Products 1

For pricing, delivery, and ordering information, please contact Maxim Direct at 1-888-629-4642, or visit Maxim's website at www.maxim-ic.com.

MAX9792A Evaluation Kit

Component Supplier

SUPPLIER	PHONE	WEBSITE
Murata Electronics North America, Inc.	770-436-1300	www.murata-northamerica.com

Note: Indicate that you are using the MAX9792A when contacting this component supplier.

Quick Start

Required Equipment

- One 5V, 3A DC Supply
- One 3Ω speaker
- One stereo headphone
- Two audio signal sources: one mono and another stereo

Procedure

The MAX9792A EV kit is fully assembled and tested. Follow the steps below to verify board operation.

Caution: Do not turn on the power supply until all connections are completed.

- 1) Verify that shunts are installed as follows:
 - JU1: Pins 2-3 (speaker amplifier enabled)
 - JU2: Pins 1-2 (headphone amplifier enabled)
 - JU3: Pins 1-2 (LDO enabled)
 - JU4: Installed (HPVDD connected to AVDD)
 - JU5: Installed (wake-on-beep function disabled)
- 2) Set the power-supply output to 5V.
- 3) Disable the power-supply output.
- 4) Connect the power-supply ground to the PGND binding post and the power-supply positive output to the AVDD binding post.
- 5) Verify that the audio source output is disabled.
- 6) Connect the stereo audio source's right channel to the HPINR phono jack and the left channel to the HPINL phono jack.
- 7) Connect the mono audio source to the SPIN phono jack.
- 8) Plug the headphone into the HPOUT headphone jack.
- 9) Connect the speaker across the SPOUT+ and SPOUT- binding posts.
- 10) Enable the power-supply output.
- 11) Enable the audio sources.
- 12) Verify that the headphones and speakers are playing the audio source signals.

Detailed Description of Hardware

The MAX9792A EV kit demonstrates the MAX9792A IC in a 28-pin TQFN package with an exposed pad. The IC combines a mono Class D amplifier, a stereo DirectDrive headphone amplifier, and a 120mA, 4.75V LDO for notebook, tablet PC, and portable media player applications. The EV kit demonstrates Maxim's DirectDrive technology, which eliminates bulky DC-blocking capacitors at the headphone amplifier output. The MAX9792A IC features adjustable gain.

The MAX9792A EV kit is configured for a 12dB speaker amplifier gain and 0dB headphone amplifier gain. The gains can be adjusted by modifying the corresponding gain-setting resistors (R1, R3, and R4). R1 sets the speaker amplifier gain while R3 and R4 set the headphone amplifier gain. The EV kit is designed to operate from a 4.5V to 5.5V speaker supply providing 3A. To use the LDO, AVDD must range from 4.9V to 5.5V. An optional separate 2.7V to 5.5V headphone supply can power the headphone amplifier. The EV kit is capable of delivering up to 3W into a 3Ω speaker, 180mW into a 32Ω headphone load, and 120mA from the 4.75V LDO output.

In applications where the speaker leads exceed 225mm, replace resistors R7 and R8 with surface-mount 0805 ferrite beads and install surface-mount 0603 capacitors for C13 and C14. Refer to the *Optional Ferrite Bead Filter* section of the MAX9791/MAX9792 IC data sheet for more information. The speaker outputs do not require an output filter as the MAX9792A relies on the inherent inductance of the speaker coil and the natural filtering of an attached speaker. For optimum results, use a speaker with a series inductance > 10μH. The EV kit layout shows an optional speaker output filter for evaluation purposes only.

MAX9792A Evaluation Kit

Evaluates: MAX9792A

Speaker/Headphone Amplifier Shutdown

Jumpers JU1 and JU2 enable or disable the speaker amplifier (SPKR_EN) and headphone amplifier (HP_EN), respectively. See Tables 1 and 2 for jumper JU1 and JU2 configuration to shut down or enable the respective amplifier.

LDO Shutdown

Jumper JU3 enables or disables the LDO (LDO_EN). To use the LDO, AVDD must range between 4.9V and 5.5V. See Table 3 for jumper JU3 configuration to shut down or enable the LDO.

Optional Headphone Supply Configuration

Jumper JU4 configures the source for the headphone power supply (HPVDD). To power HPVDD using AVDD, install a shunt on jumper JU4. To use an optional separate supply for HPVDD, do not install a shunt on jumper JU4 and connect a 2.7V to 5.5V supply across the HPVDD and PGND binding posts. See Table 4 for jumper JU4 configuration.

Wake-on-Beep

Jumper JU5 controls the MAX9792A EV kit's wake-on-beep feature. A qualified BEEP signal overrides HP_EN and SPKR_EN enabling the speaker and headphone amplifiers. Refer to the *Wake-on-Beep* section of the MAX9791/MAX9792 IC data sheet for more information. To use the wake-on-beep feature, remove the shunt from jumper JU5, connect a user-supplied BEEP signal across the BEEP and nearby PGND PCB pads. **Note:** Do not leave the BEEP pin unconnected. The LDO must be enabled to use the wake-on-beep feature. See Table 5 for jumper JU5 configuration.

Table 1. Speaker Amplifier (JU1)

SHUNT POSITION	SPKR_EN PIN	SPEAKER AMPLIFIER
1-2	Connected to AVDD	Disabled
2-3*	Connected to PGND	Enabled

*Default position.

Table 2. Headphone Amplifier (JU2)

SHUNT POSITION	HP_EN PIN	HEADPHONE AMPLIFIER
1-2*	Connected to AVDD	Enabled
2-3	Connected to PGND	Disabled

*Default position.

Table 3. LDO (JU3)

SHUNT POSITION	LDO_EN PIN	4.75V LDO
1-2*	Connected to AVDD	Enabled
2-3	Connected to PGND	Disabled

*Default position.

Table 4. Headphone Supply (JU4)

SHUNT POSITION	HPVDD PIN	HPVDD POWER-SUPPLY SOURCE
Installed*	Connected to AVDD	AVDD supply
Not installed	Connected to HPVDD binding post	Optional separate 2.7V to 5.5V supply

*Default position.

Table 5. Wake-on-Beep (JU5)

SHUNT POSITION	BEEP PIN	WAKE-ON-BEEP FEATURE
Installed*	Connected to PGND	Disabled
Not installed	Connected to BEEP PCB pad	Enabled with a user-supplied BEEP output; the LDO must be enabled (see Table 4)

*Default position.

MAX9792A Evaluation Kit

Speaker and Headphone Gain Setting

The default gain-setting resistor (R1) configures the speaker amplifier gain to 12dB, while the default gain-setting resistors (R3 and R4) configure the headphone amplifier gain to 0dB. The gain can be changed by replacing these resistors with other surface-mount 0603 resistors. Use $\pm 1\%$ tolerance resistors for optimum performance. See Table 6 and the following equations to select new gain-setting resistors in kilohms for the corresponding channel:

$$R_{IN_SPKR} [k\Omega] = -4 \times \left(\frac{20k\Omega}{A_{VSPKR}} \right)$$

where A_{VSPKR} is the desired speaker voltage gain and R_{IN_SPKR} is the speaker amplifier's input resistor (R1).

$$R_{IN_HP} [k\Omega] = - \left(\frac{40.2k\Omega}{A_{VHP}} \right)$$

where A_{VHP} is the desired headphone voltage gain and R_{IN_HP} is the headphone amplifier input resistors (R3 or R4).

Table 6. Component Function

CHANNEL	RIN
Speaker	R1
Headphone right	R3
Headphone left	R4

MAX9792A Evaluation Kit

Evaluates: **MAX9792A**

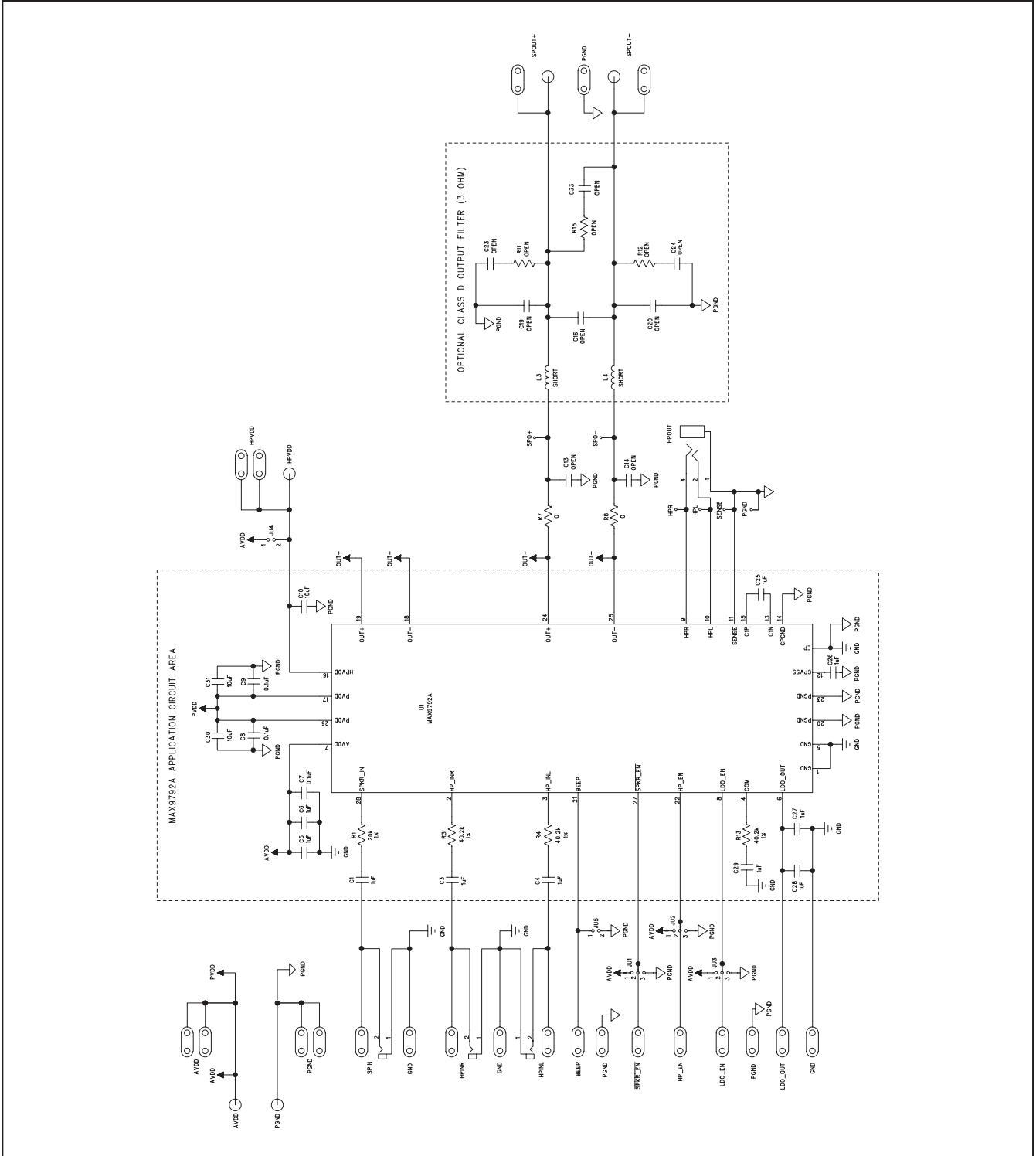

Figure 1. MAX9792A EV Kit Schematic



MAX9792A Evaluation Kit

Evaluates: MAX9792A

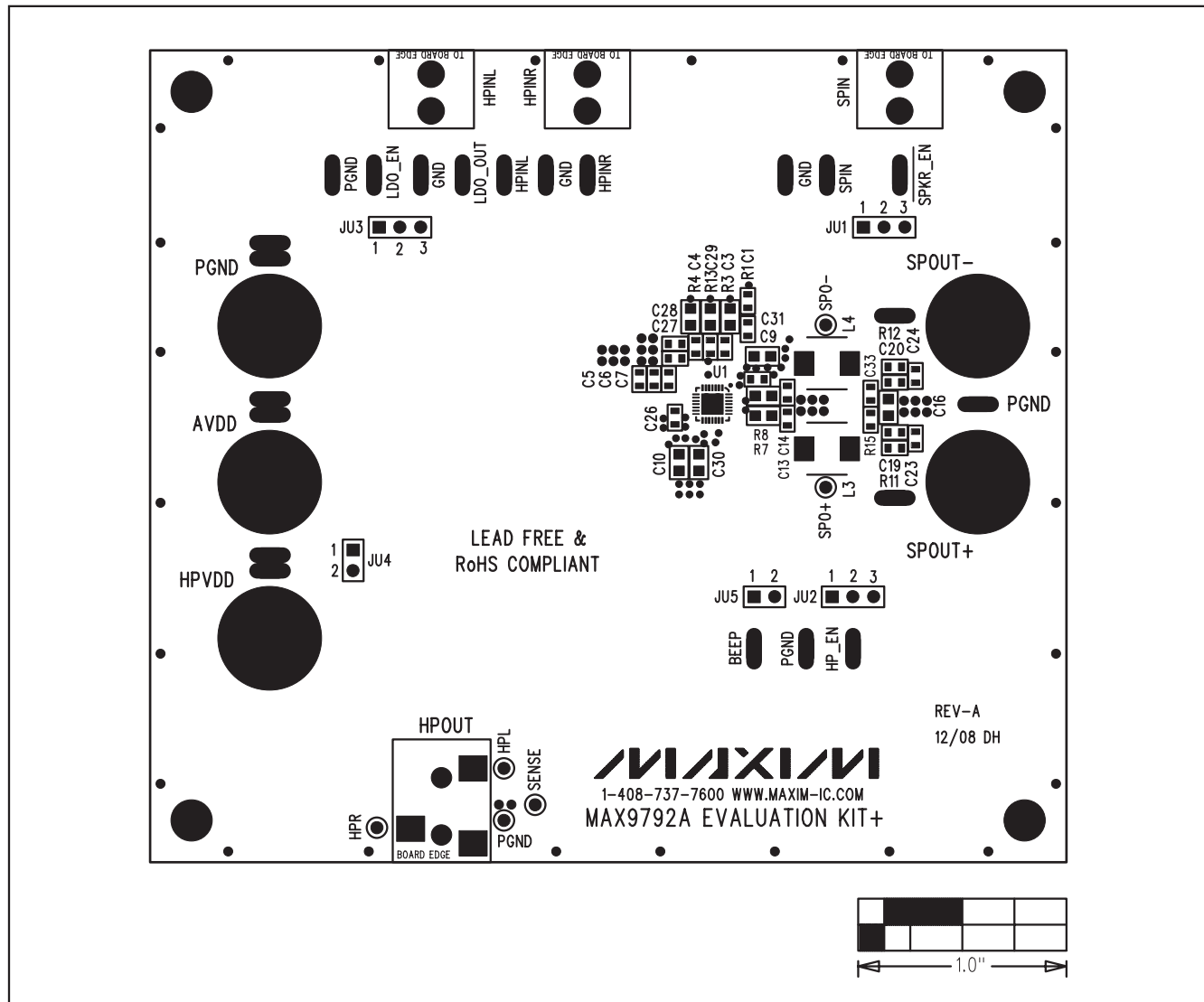

Figure 2. MAX9792A EV Kit Component Placement Guide—Component Side

MAX9792A Evaluation Kit

Evaluates: MAX9792A

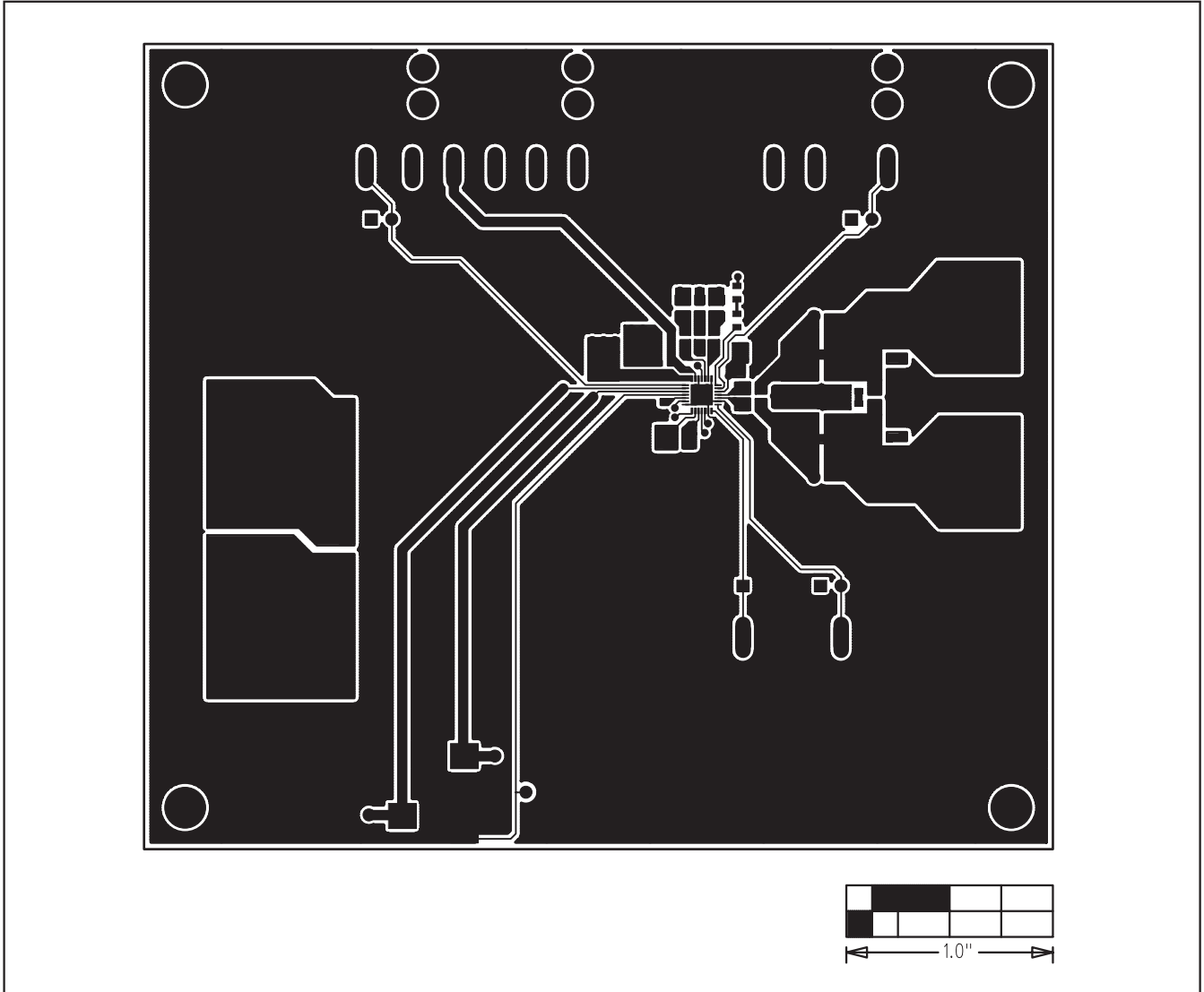

Figure 3. MAX9792A EV Kit PCB Layout—Component Side

MAX9792A Evaluation Kit

Evaluates: MAX9792A

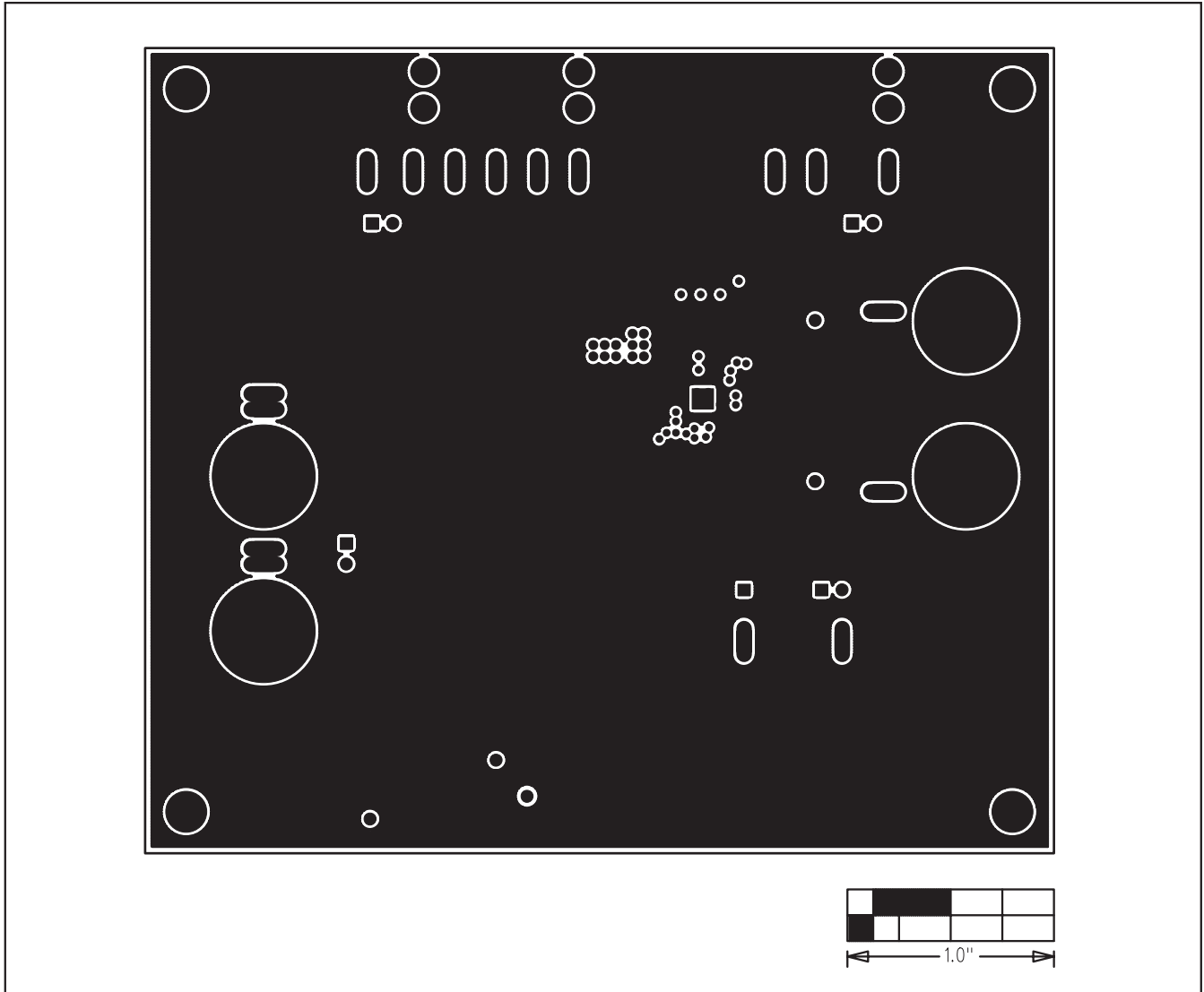

Figure 4. MAX9792A EV Kit PCB Layout—Layer 2

MAX9792A Evaluation Kit

Evaluates: MAX9792A

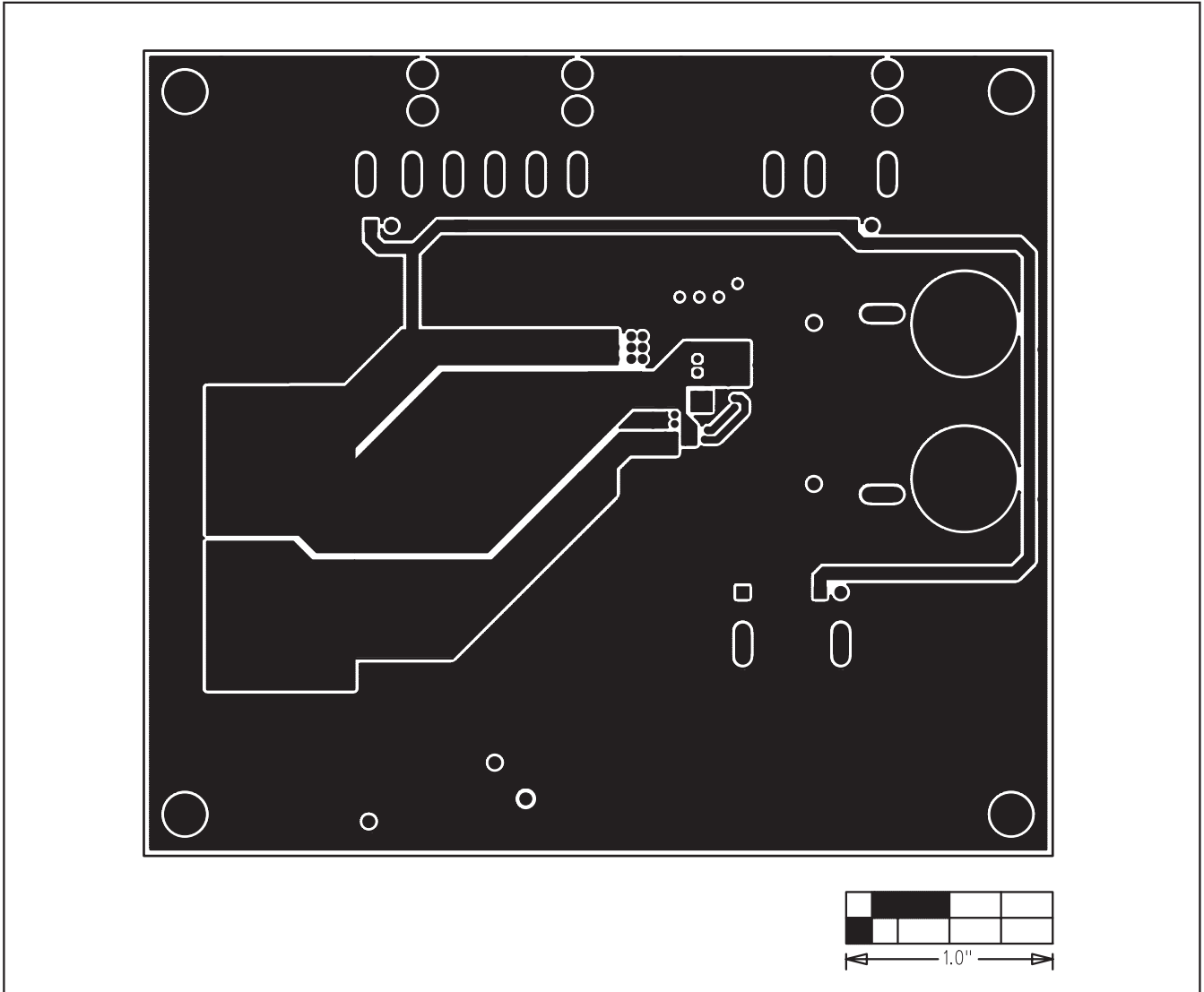

Figure 5. MAX9792A EV Kit PCB Layout—Layer 3

MAX9792A Evaluation Kit

Evaluates: MAX9792A

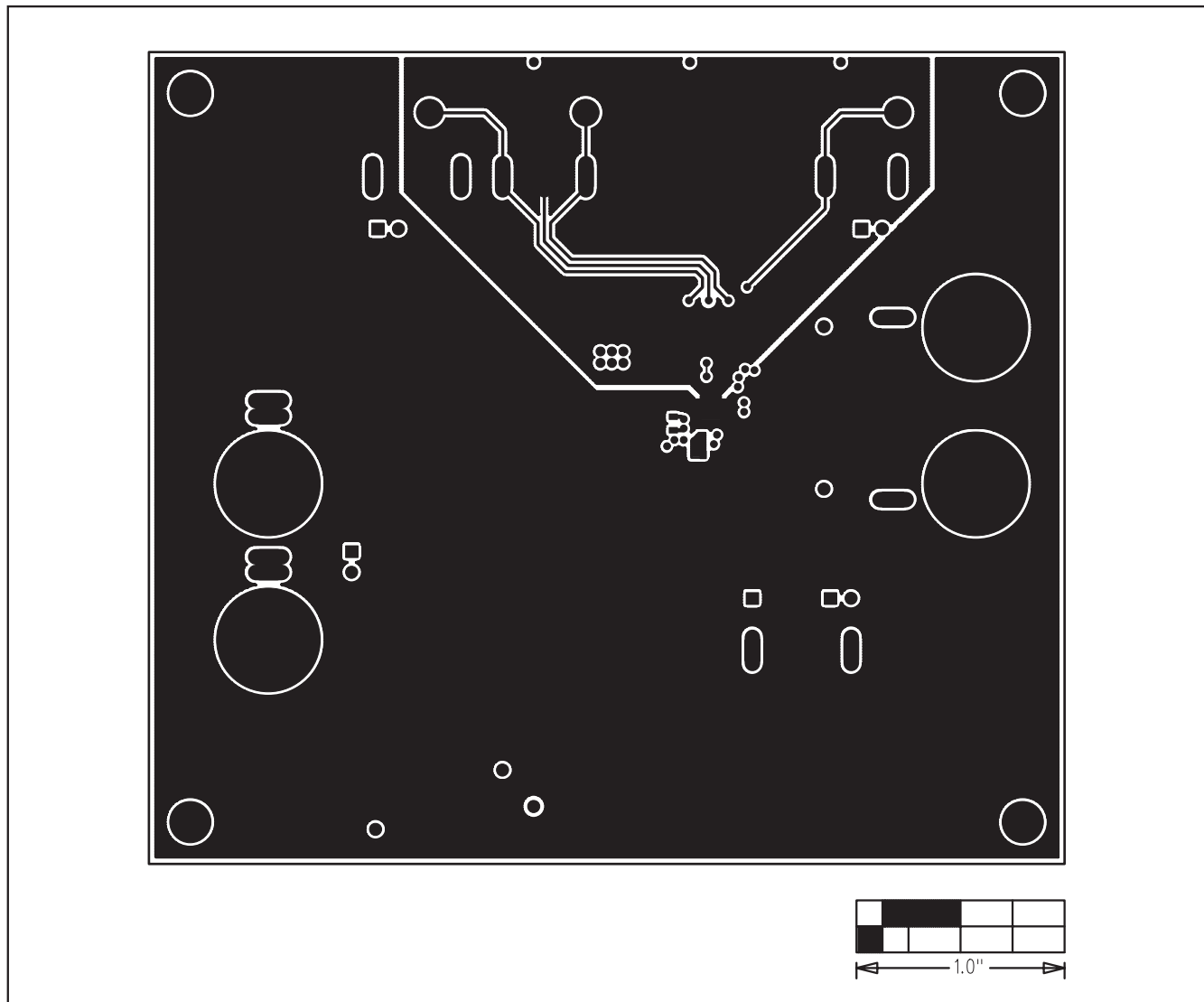

Figure 6. MAX9792A EV Kit PCB Layout—Solder Side

MAX9792A Evaluation Kit

Evaluates: MAX9792A

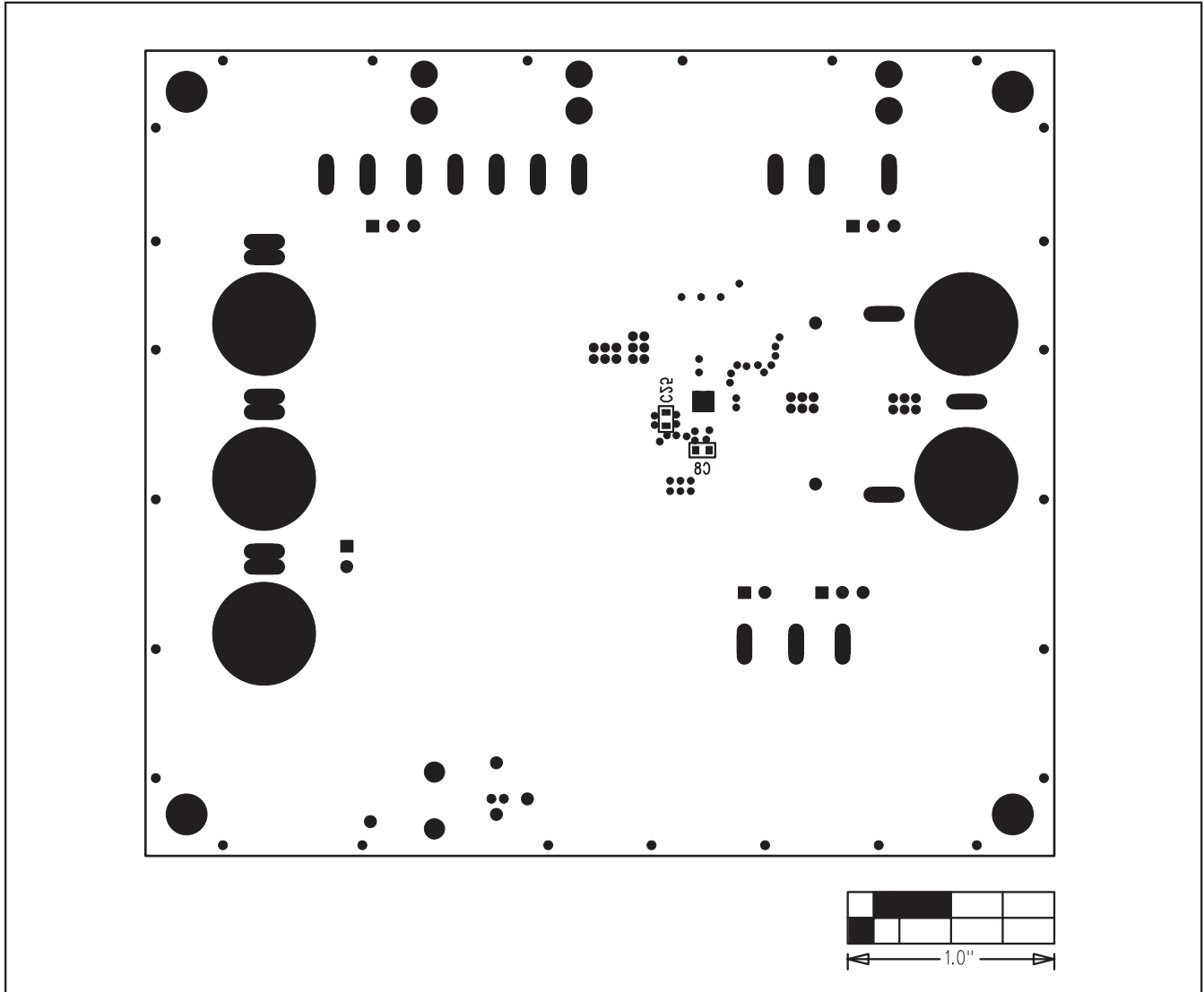

Figure 7. MAX9792A EV Kit Component Placement Guide—Solder Side

Maxim cannot assume responsibility for use of any circuitry other than circuitry entirely embodied in a Maxim product. No circuit patent licenses are implied. Maxim reserves the right to change the circuitry and specifications without notice at any time.

Maxim Integrated Products, 120 San Gabriel Drive, Sunnyvale, CA 94086 408-737-7600 _____ 11