

Low-Power Audio CODEC with DirectDrive Headphone Amplifiers

General Description

The MAX9856 is a high-performance, low-power stereo audio CODEC designed for MP3, personal media players (PMPs), or other portable multimedia devices. Using on-board stereo DirectDrive® headphone amplifiers, the CODEC can output 30mW into stereo 32Ω headphones while operating from a single 1.8V power supply. Very low 9mW playback power consumption makes it an ideal choice for battery-powered applications. The MAX9856 provides microphone input amplifiers, plus flexible input selection, signal mixing, and automatic gain control (AGC). Comprehensive load-impedance sensing allows the MAX9856 to autodetect most common audio and audio/video headset and jack plug types.

Outputs include stereo DirectDrive line outputs and DirectDrive headphone amplifiers. The stereo DAC can convert audio signals from either internal or external microphones that can be configured for single-ended or differential signal inputs. Line inputs can be configured as stereo, differential, or mono and fed through one channel of the microphone path. The analog inputs selected can be gain ranged or mixed with other input sources prior to conversion to digital. The ADC path also features programmable digital highpass filters to remove DC offset voltages and wind noise.

The MAX9856 supports all common sample rates from 8kHz to 48kHz in both master and slave mode. The serial digital audio interfaces support a variety of formats including I²S, left-justified, and PCM modes.

The MAX9856 uses a thermally efficient, space-saving 40-pin, 6mm x 6mm x 0.8mm TQFN package.

Applications

MP3 Players
Personal Media Players
Handheld Gaming Consoles
Cellular Phones

Pin Configuration appears at end of data sheet.

DirectDrive is a registered trademark of Maxim Integrated Products, Inc.

Features

- ◆ 1.71V to 3.6V Single-Supply Operation
- ◆ Stereo 30mW DirectDrive Headphone Amplifier
- ◆ Stereo 1V_{RMS} DirectDrive Line Outputs (V_{DD} = 1.8V) and Stereo Line Inputs
- ◆ Low-Noise Stereo and Mono Differential Microphone Inputs with Automatic Gain Control and Noise Quieting
- ◆ 9mW Playback Power Consumption (V_{DD} = 1.8V)
- ◆ 91dB 96kHz 18-Bit Stereo DAC
- ◆ 85dB 48kHz 18-Bit Stereo ADC
- ◆ Supports Any Master Clock Frequency from 10MHz to 60MHz
- ◆ ADCs and DACs Can Run at Independent Sample Rates
- ◆ Flexible Audio Mixing and Volume Control
- ◆ Clickless/Popless Operation
- ◆ Headset Detection Logic
- ◆ I²C Control Interface

Ordering Information

PART	TEMP RANGE	PIN-PACKAGE
MAX9856ETL+	-40°C to +85°C	40 TQFN-EP*
MAX9856GTLV+	-40°C to +105°C	40 TQFN-EP*

+ Denotes a lead-free/RoHS-compliant package.

*EP = Exposed pad.

V denotes an automotive qualified part.

Simplified Block Diagram

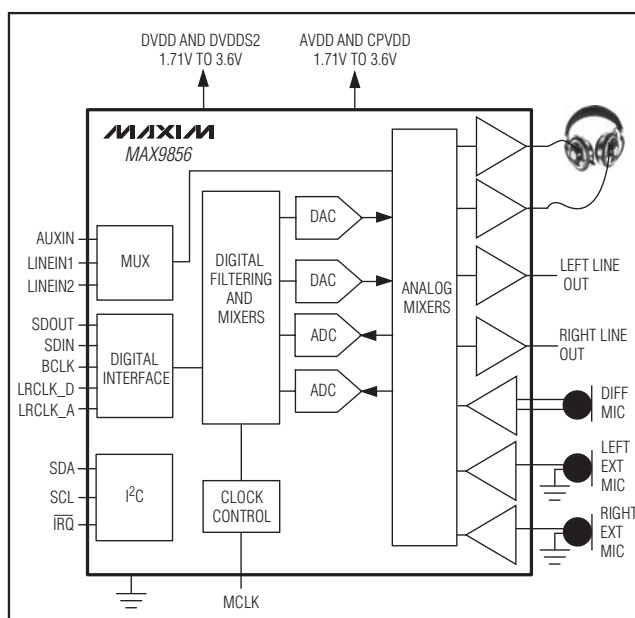

Low-Power Audio CODEC with DirectDrive Headphone Amplifiers

ABSOLUTE MAXIMUM RATINGS

(Voltages with respect to AGND.)

AVDD, DVDD, DVDDS2, CPVDD	-0.3V to +4V
PVSS, SVSS	Capacitor connection only
AGND, DGND, CPGND	-0.3V to +0.3V
HPL, HPR	(V _{SVSS} - 0.3V) to (V _{AVDD} + 0.3V)
HGNDNSNS, LGNDNSNS, MICGND	-0.3V to +0.3V
JACKSNS	(V _{SVSS} - 0.3V) to (V _{AVDD} + 0.3V)
LOUTL, LOUTr	(V _{SVSS} - 0.3V) to (V _{AVDD} + 0.3V)
LINEIN1, LINEIN2, AUXIN	-2V to +2V
MICL, MICR, INLP, INLM, INRM	-2V to +2V
C1N	(V _{PVSS} - 0.3V) to (V _{CPGND} + 0.3V)
C1P	(V _{CPGND} - 0.3V) to (V _{CPVDD} + 0.3V)
PREG, REF, MBIAS, MICBIAS	-0.3V to (V _{AVDD} + 0.3V)
NREG	(V _{SVSS} - 0.3V) to +0.3V
MCLK	-0.3V to +4V
SDA, SCL, I ² C	-0.3V to +4V
LRCLK_A, LRCLK_D, BCLK, SDIN, SDOUT	-0.3V to (V _{DVDDS2} + 0.3V)

Continuous Current Into/Out of HPR/HPL/LOUTL/LOUTr	150mA
CPVDD/CPGND/C1P/C1N/PVSS	300mA
Any Other Pin	20mA
Duration of HPR/HPL/LOUTL/LOUTr Short Circuit to AVDD/AGND/CPVDD/CPGND	Continuous
Continuous Power Dissipation (T _A = +70°C)	
40-Pin TQFN (derate 26.3mW/°C above +70°C, single-layer board)	2105mW
40-Pin TQFN (derate 37mW/°C above +70°C, multilayer board)	2963mW
Operating Temperature Ranges:	
E Series	-40°C to +85°C
G Series	-40°C to +105°C
Storage Temperature Range	-65°C to +150°C
Lead Temperature (soldering, 10s)	+300°C
Soldering Temperature (reflow)	+260°C

Stresses beyond those listed under "Absolute Maximum Ratings" may cause permanent damage to the device. These are stress ratings only, and functional operation of the device at these or any other conditions beyond those indicated in the operational sections of the specifications is not implied. Exposure to absolute maximum rating conditions for extended periods may affect device reliability.

ELECTRICAL CHARACTERISTICS

(V_{AVDD} = V_{CPVDD} = V_{DVDDS2} = V_{DVDD} = 1.8V, R_{HP} = 32Ω, R_{LINE} = 10kΩ, C₁ = 4.7μF, C₂ = 4.7μF, C_{REF} = C_{MBIAS} = C_{PREG} = C_{NREG} = 1μF, A_{VPRE} = +20dB, C_{MICBIAS} = 1μF, A_{VMIGPGA} = 0dB, f_{MCLK} = 11.2896MHz, DRATE = 00, T_A = T_{MIN} to T_{MAX}, unless otherwise noted. Typical values are at T_A = +25°C.) (Note 1)

PARAMETER	SYMBOL	CONDITIONS	MIN	TYP	MAX	UNITS	
Supply Voltage Range		AVDD = CPVDD (inferred from HP output PSRR)	1.71	1.80	3.60	V	
		DVDD, DVDDS2 (inferred from CODEC performance tests)	1.71	1.80	3.60		
Total Supply Current (Note 2)	I _{VDD}	DAC playback mode (f _s = 44.1kHz) analog	I _{AVDD} + I _{CPVDD}		2.9	5.1	mA
			I _{DVDD} + I _{DVDDS2}		2.3		
		Line-only playback mode (DAC/ADC disabled)	I _{AVDD} + I _{CPVDD}		2.9	4.3	
			I _{DVDD} + I _{DVDDS2}		0.14	0.20	
		DAC + line input playback mode (f _s = 44.1kHz)	I _{AVDD} + I _{CPVDD}		3.9	5.4	
			I _{DVDD} + I _{DVDDS2}		2.3	3.5	
		Full operation, f _s = 44.1kHz (DAC + ADC + LINEIN + MIC + AUXIN)	I _{AVDD} + I _{CPVDD}		11.0	15.5	
			I _{DVDD} + I _{DVDDS2}		3.7	4.5	
DAC playback, f _s = 44.1kHz mono ADC record f _s = 8kHz	I _{AVDD} + I _{CPVDD}		6.6	9.1			
	I _{DVDD} + I _{DVDDS2}		2.8	3.5			
ADC record, f _s = 44.1kHz	I _{AVDD} + I _{CPVDD}		7.8	10.5			
	I _{DVDD} + I _{DVDDS2}		2.3	3.5			
Shutdown Supply Current		I _{AVDD} + I _{CPVDD}		2.2	10	μA	
		I _{DVDD} + I _{DVDDS2}		0.6	10		
Shutdown to Full Operation				50		ms	

Low-Power Audio CODEC with DirectDrive Headphone Amplifiers

MAX9856

ELECTRICAL CHARACTERISTICS (continued)

($V_{AVDD} = V_{CPVDD} = V_{DVDD2} = V_{DVDD} = 1.8V$, $R_{HP} = 32\Omega$, $R_{LINE} = 10k\Omega$, $C_1 = 4.7\mu F$, $C_2 = 4.7\mu F$, $C_{REF} = C_{MBIAS} = C_{PREG} = C_{NREG} = 1\mu F$, $A_{VPRE} = +20dB$, $C_{MICBIAS} = 1\mu F$, $A_{VMIGPGA} = 0dB$, $f_{MCLK} = 11.2896MHz$, $DRATE = 00$, $T_A = T_{MIN}$ to T_{MAX} , unless otherwise noted. Typical values are at $T_A = +25^\circ C$.) (Note 1)

PARAMETER	SYMBOL	CONDITIONS	MIN	TYP	MAX	UNITS
STEREO DAC (Note 3)						
Gain Error				± 1	± 5	%
Channel Gain Mismatch				± 1		%
DAC DYNAMIC SPECIFICATIONS						
Dynamic Range (Note 4)		$f_S = 44.1kHz$, A-weighted, $DRATE = 10$	80	91		dB
		$f_S = 8kHz$ to $96kHz$, A-weighted	$DRATE = 00$	87		
			$DRATE = 10$	91		
Total Harmonic Distortion	THD	$f_{IN} = 1kHz$, $f_S = 8kHz$ to $96kHz$, $0dBFS$		82		dB
Signal-to-Noise Ratio	SNR	$f_S = 8kHz$ to $96kHz$, A-weighted (Note 5)	$DRATE = 00$	87		dB
			$DRATE = 10$	91		
Crosstalk		Driven channel at $-1dBFS$, $f_{IN} = 1kHz$, $f_S = 8kHz$		78		dB
Power-Supply Rejection Ratio	PSRR	$f = 217Hz$, $V_{RIPPLE} = 100mV$, $A_{VPGA} = 0dB$		93		dB
		$f = 10kHz$, $V_{RIPPLE} = 100mV$, $A_{VPGA} = 0dB$		60		
DAC DIGITAL FILTER (8x interpolation, FIR ($f_S = 7.8kHz$ to $50kHz$))						
Passband Cutoff	f_p	$-0.2dB$ from peak		0.44		f_S
Passband Ripple		$f < 0.44 \times f_S$		± 0.1		dB
Stopband Cutoff	f_s			0.58		f_S
Stopband Attenuation		$f > f_S$		58		dB
Attenuation at $f_S/2$				-6.02		dB
DAC DIGITAL FILTER (4x interpolation, FIR ($f_S = 50kHz$ to $100kHz$))						
Passband Cutoff	f_p	$-0.2dB$ from peak		0.24		f_S
Passband Ripple		$f < 0.23 \times f_S$		± 0.1		dB
Stopband Cutoff	f_s			0.5		f_S
Stopband Attenuation		$f > f_S$		54		dB
Attenuation at $f_S/2$				-60		dB
DAC HIGHPASS FILTER						
-3dB Corner Frequency ($f_S = 44.1kHz$)	HPFILT	DACHP = 000		Disabled		Hz
		DACHP = 001; LRCLK/1598		28		
		DACHP = 010; LRCLK/798		55		
		DACHP = 011; LRCLK/398		111		
		DACHP = 100; LRCLK/197		224		
		DACHP = 101; LRCLK/97		455		
		DACHP = 110; LRCLK/47		938		
		DACHP = 111; LRCLK/22		2004		
DC Attenuation	DCATTEN	DACHP \neq 000		60		dB

Low-Power Audio CODEC with DirectDrive Headphone Amplifiers

ELECTRICAL CHARACTERISTICS (continued)

($V_{AVDD} = V_{CPVDD} = V_{DVDDS2} = V_{DVDD} = 1.8V$, $R_{HP} = 32\Omega$, $R_{LINE} = 10k\Omega$, $C_1 = 4.7\mu F$, $C_2 = 4.7\mu F$, $C_{REF} = C_{MBIAS} = C_{PREG} = C_{NREG} = 1\mu F$, $A_{VPRE} = +20dB$, $C_{MICBIAS} = 1\mu F$, $A_{VMIGPGA} = 0dB$, $f_{MCLK} = 11.2896MHz$, $DRATE = 00$, $T_A = T_{MIN}$ to T_{MAX} , unless otherwise noted. Typical values are at $T_A = +25^\circ C$.) (Note 1)

PARAMETER	SYMBOL	CONDITIONS	MIN	TYP	MAX	UNITS
STEREO ADC (Note 6)						
Gain Error				± 1	± 5	%
Full-Scale Conversion	0dBFS	$f_{IN} = 1kHz$, line input PGA = 0dB		2		VP-P
Channel Gain Mismatch				± 1		%
ADC DYNAMIC SPECIFICATIONS						
Dynamic Range (Note 4)		$f_S = 8kHz$ to $32kHz$, BW = 22Hz to $f_S/2$		80		dB
		$f_S = 44.1kHz$, BW = 22Hz to 20kHz, A-weighted	78	84		
		$f_S = 48kHz$, BW = 22Hz to 20kHz, A-weighted		85		
Total Harmonic Distortion	THD	1kHz, 0dBFS, $f_S = 8kHz$		-63		dB
		1kHz, 0dBFS, $f_S = 48kHz$		-68		
Signal-to-Noise Ratio	SNR	1kHz, 0dBFS, $f_S = 8kHz$, BW = 22Hz to 20kHz, A-weighted		77		dB
		1kHz, 0dBFS, $f_S = 48kHz$, BW = 22Hz to 20kHz, A-weighted		77		
Channel Crosstalk		Driven channel at -1dBFS, $f_{IN} = 1kHz$, $f_S = 8kHz$		65		dB
Power-Supply Rejection Ratio (Note 7)	PSRR	$V_{AVDD} = 1.71V$ to 3.6V	60	100		dB
		$f = 1kHz$, $V_{RIPPLE} = 100mV$		80		
		$f = 10kHz$, $V_{RIPPLE} = 100mV$		50		
ADC DIGITAL FILTER PATH						
Passband Cutoff	f_p	-0.2dB from peak		0.44		f_S
Passband Ripple		$f < f_p$		± 0.1		dB
Stopband Cutoff	f_s			0.56		f_S
Stopband Attenuation		$f > f_s$		60		dB
Attenuation at $f_S/2$				-6.02		dB
ADC HIGHPASS FILTER						
-3dB Corner Frequency ($f_S = 44.1kHz$)	HPFILT	ADCHP = 000		Disabled		Hz
		ADCHP = 001; LRCLK/1598		28		
		ADCHP = 010; LRCLK/798		55		
		ADCHP = 011; LRCLK/398		111		
		ADCHP = 100; LRCLK/197		224		
		ADCHP = 101; LRCLK/97		455		
		ADCHP = 110; LRCLK/47		938		
		ADCHP = 111; LRCLK/22		2004		
DC Attenuation	DCATTEN	ADCHP anything other than 000		90		dB
DC Output Offset		ADCHP = 000		-40		dBFS

Low-Power Audio CODEC with DirectDrive Headphone Amplifiers

MAX9856

ELECTRICAL CHARACTERISTICS (continued)

($V_{AVDD} = V_{CPVDD} = V_{DVDD2} = V_{DVDD} = 1.8V$, $R_{HP} = 32\Omega$, $R_{LINE} = 10k\Omega$, $C_1 = 4.7\mu F$, $C_2 = 4.7\mu F$, $C_{REF} = C_{MBIAS} = C_{PREG} = C_{NREG} = 1\mu F$, $A_{VPRE} = +20dB$, $C_{MICBIAS} = 1\mu F$, $A_{VMIGPGA} = 0dB$, $f_{MCLK} = 11.2896MHz$, $DRATE = 00$, $T_A = T_{MIN}$ to T_{MAX} , unless otherwise noted. Typical values are at $T_A = +25^\circ C$.) (Note 1)

PARAMETER	SYMBOL	CONDITIONS	MIN	TYP	MAX	UNITS
ADC/DAC DATA RATE ACCURACY						
LRCLK_D and LRCLK_A Output Average Sample Rate Deviation (Master Mode, Any MCLK)		(Note 8)	-0.025		+0.025	%
LRCLK_D Output Sample Rate Deviation (Master Mode)		PCLK/LRCLK = 1536, 1024, 768, 512, 384, 256, 192, or 128		0		%
LRCLK Input Sample Rate Range (Slave Mode)		LRCLK_A, LRCLK_D (DHF = 0)	7.8		50	kHz
		LRCLK_D (DHF = 1)	15.6		100	
LRCLK_D and LRCLK_A PLL Lock Time	t_{LOCK}	Any allowable LRCLK and PCLK rates		12	25	ms
LRCLK_D and LRCLK_A Acceptable Jitter for Maintaining PLL Lock (All Slave Modes)		Allowable LRCLK period change from nominal for slave PLL mode at any allowable LRCLK and PCLK rates			± 20	ns
HEADPHONE AMPLIFIERS						
Output Power	P_{OUT}	$f = 1kHz$, THD < 1%, $T_A = +25^\circ C$	$R_L = 16\Omega$	35		mW
			$R_L = 32\Omega$	15	28	
0dBFS DAC Output Voltage		+0dB volume setting	3.40	3.51	3.80	V_{P-P}
Line In to HP Out Voltage Gain		+4.5dB volume setting, 0dB PGA setting	1.77			V/V
Output Offset Voltage	V_{OS}	$T_A = +25^\circ C$, -40dB volume setting	± 0.6		± 4	mV
Total Harmonic Distortion Plus Noise	THD+N	$R_L = 32\Omega$, $P_{OUT} = 25mW$, $f = 1kHz$	0.03			%
		$R_L = 16\Omega$, $P_{OUT} = 25mW$, $f = 1kHz$	0.05			
Dynamic Range	DR	+5.5dB volume setting, DAC input at $f_S = 44.1kHz$ (Note 4)	80	91		dB
Power-Supply Rejection Ratio	PSRR	$V_{AVDD} = 1.71V$ to $3.6V$	70	94		dB
		$V_{RIPPLE} = 100mV_{P-P}$, $f = 217Hz$	80			
		$V_{RIPPLE} = 100mV_{P-P}$, $f = 10kHz$	50			
Capacitive Drive	C_L	No sustained oscillations	150			pF
Crosstalk		$P_{OUT} = 1.6mW$, $f = 1kHz$, (HPL to HPR) or (HPR to HPL)	69			dB
Channel Gain Matching	A_{VMATCH}		± 2			%
Click-and-Pop Level		Peak voltage, A-weighted, 32 samples per second	Into shutdown	-70		dBV
			Out of shutdown	-70		
LINE AMPLIFIERS						
0dBFS DAC Output Voltage			1.0			V_{RMS}
Line-In to Line-Out Voltage Gain		0dB input PGA setting	1.3	1.34	1.4	V/V
Output Offset Voltage	V_{OS}	$T_A = +25^\circ C$	± 0.7		± 10	mV

Low-Power Audio CODEC with DirectDrive Headphone Amplifiers

ELECTRICAL CHARACTERISTICS (continued)

($V_{AVDD} = V_{CPVDD} = V_{DVDD2} = V_{DVDD} = 1.8V$, $R_{HP} = 32\Omega$, $R_{LINE} = 10k\Omega$, $C_1 = 4.7\mu F$, $C_2 = 4.7\mu F$, $C_{REF} = C_{MBIAS} = C_{PREG} = C_{NREG} = 1\mu F$, $A_{VPRE} = +20dB$, $C_{MICBIAS} = 1\mu F$, $A_{VMIGPGA} = 0dB$, $f_{MCLK} = 11.2896MHz$, $DRATE = 00$, $T_A = T_{MIN}$ to T_{MAX} , unless otherwise noted. Typical values are at $T_A = +25^\circ C$.) (Note 1)

PARAMETER	SYMBOL	CONDITIONS	MIN	TYP	MAX	UNITS	
Total Harmonic Distortion Plus Noise	THD+N	$V_{OUT} = 1V_{RMS}$, $f = 1kHz$		0.024		%	
Signal-to-Noise Ratio	SNR			98		dB	
Power-Supply Rejection Ratio	PSRR	$V_{AVDD} = 1.71V$ to $3.6V$	70	108		dB	
		$V_{RIPPLE} = 100mV_{P-P}$, $f = 217Hz$		93			
		$V_{RIPPLE} = 100mV_{P-P}$, $f = 10kHz$		60			
Capacitive Drive	C_L	No sustained oscillations		150		pF	
Crosstalk		$V_{OUT} = 2V_{P-P}$, $f = 1kHz$, (LOUTL to LOUTr) or (LOUTr to LOUtl)		98		dB	
Channel Gain Matching	A_{VMATCH}			± 2		%	
VOLUME CONTROL							
Headphone Volume Control Range			-74.0		+5.5	dB	
Headphone Volume Control Step Size		5.5dB to 2dB		0.5		dB	
		+2.5dB to -2dB		1			
		-2dB to -46dB		2			
		-46dB to -74dB		4			
Headphone Mute Attenuation		$f = 1kHz$		92		dB	
CHARGE PUMP							
Charge-Pump Oscillator Frequency	f_{OSC}	$T_A = +25^\circ C$	600	665	720	kHz	
MICROPHONE AMPLIFIERS							
Preamp Gain	A_{VPRE}	MICL or MICR	PALEN/PAREN = 01	-0.5	0	+0.5	dB
			PALEN/PAREN = 10	19	20	21	
			PALEN/PAREN = 11	28.5	30.0	31.5	
MIC PGA Gain	$A_{VMICPGA}$	PGAML/R = 0x20	-0.5	0	+0.5	dB	
		PGAML/R = 0x00	19.5	20.0	19.5		
MIC PGA Gain Step Size				1		dB	
MIC Mute Attenuation		$f = 1kHz$		92		dB	
Common-Mode Rejection Ratio	CMRR	INL_{\pm} , $V_{IN} = 100mV_{P-P}$ at 217Hz, $A_{VPRE} = +20dB$		73		dB	
MIC Input Resistance	R_{IN_MIC}	INL_{\pm} , MICL or MICR, $A_{VPRE} = +30dB$	4	8	10	k Ω	
		INL_{\pm} , MICL or MICR, $A_{VPRE} = +20dB$	12	18	28		
		INL_{\pm} , MICL or MICR, $A_{VPRE} = 0dB$	60	100	160		
MIC Input Resistance Matching	R_{MATCH}	$INL+$ to $INL-$ or MICL/MICR to AGND		1		%	
MIC Input Bias Voltage	V_{CML}	Measured at INL_{\pm} , MICR, MICL, and AGND	-0.05	0	+0.05	V	
Input Voltage Noise		$f = 1kHz$, $A_{VPRE} = +30dB$		15		nV/ \sqrt{Hz}	

Low-Power Audio CODEC with DirectDrive Headphone Amplifiers

MAX9856

ELECTRICAL CHARACTERISTICS (continued)

($V_{AVDD} = V_{CPVDD} = V_{DVDDSS2} = V_{DVDD} = 1.8V$, $R_{HP} = 32\Omega$, $R_{LINE} = 10k\Omega$, $C_1 = 4.7\mu F$, $C_2 = 4.7\mu F$, $C_{REF} = C_{MBIAS} = C_{PREG} = C_{NREG} = 1\mu F$, $A_{VPRE} = +20dB$, $C_{MICBIAS} = 1\mu F$, $A_{VMICPGA} = 0dB$, $f_{MCLK} = 11.2896MHz$, $DRATE = 00$, $T_A = T_{MIN}$ to T_{MAX} , unless otherwise noted. Typical values are at $T_A = +25^\circ C$.) (Note 1)

PARAMETER	SYMBOL	CONDITIONS	MIN	TYP	MAX	UNITS
Total Harmonic Distortion Plus Noise	THD+N	$A_{VPRE} = 0dB$, $A_{VMICPGA} = 0dB$, $V_{IN} = 500mV_{p-p}$, $f = 1kHz$, A-weighted		0.04		%
		$A_{VPRE} = +20dB$, $A_{VMICPGA} = 0dB$, $V_{IN} = 50mV_{p-p}$, $f = 1kHz$, A-weighted		0.08		
		$A_{VPRE} = +30dB$, $A_{VMICPGA} = 0dB$, $V_{IN} = 18mV_{p-p}$, $f = 1kHz$, A-weighted		0.08		
MIC Power-Supply Rejection Ratio	PSRR	$V_{AVDD} = 1.71V$ to $3.6V$, $T_A = +25^\circ C$	79	80		dB
		$V_{RIPPLE} = 100mV$ at $1kHz$, input referred		80		
		$V_{RIPPLE} = 100mV$ at $10kHz$, input referred		50		
MICROPHONE BIAS						
MICBIAS Output Voltage	$V_{MICBIAS}$	$V_{AVDD} = 1.8V$ ($MBSEL = 0$ register setting)	1.4	1.5	1.6	V
		$V_{AVDD} = 3.0V$ ($MBSEL = 1$ register setting)	2.3	2.4	2.5	
MICBIAS Load Regulation		$I_{MICBIAS} = 0$ to $2mA$		0.8	10	Ω
MICBIAS Capacitive Load		Minimum capacitive load		1		μF
MICBIAS Short-Circuit Current		To GND		14		mA
MICBIAS Power-Supply Rejection Ratio	PSRR	$V_{AVDD} = 1.71V$ to $3.6V$, $MBSEL = 0$, $T_A = +25^\circ C$	75	86		dB
		$V_{RIPPLE} = 100mV$ at $1kHz$		86		
		$V_{RIPPLE} = 100mV$ at $10kHz$		76		
MICBIAS Noise Voltage	$V_{NOISEMICBIAS}$	$MBSET = 0$ or 1	$f = 10Hz$ to $20kHz$		3	μV_{RMS}
			$f = 1kHz$		20	nV/\sqrt{Hz}
AUTOMATIC GAIN CONTROL						
Threshold Level		Set by $AGCSTH[3:0]$	-3		-18	dB
Attack Time		Set by $AGCATK[1:0]$	3		200	ms
Release Time		Set by $AGCRLS[2:0]$	0.078		10.000	s
Hold Time		Set by $AGCHLD[1:0]$	50		400	ms
Gain Adjustment Range		$A_{VPRE} = +30dB$		30 to 50		dB
		$A_{VPRE} = +20dB$		20 to 40		
		$A_{VPRE} = 0dB$		0 to 20		
ADC LOW-LEVEL QUIETING						
NG Attack and Release Time		Full 12dB quieting at 1dB of attenuation/(gain) for every 2dB decrease/(increase) of signal level (immediate release if $PGA < 20dB$ gain when AGC is enabled)		0.5		s
NG Threshold Level		$ANTH[3:0]$ setting range (AGC off) (AGC on adjusts these values by 20dB since low-level signals cause maximum AGC gain in the PGA)	-64		-28	dB
NG Attenuation		1dB of attenuation for every 2dB signal amplitude decrease from NG threshold	0		12	dB

Low-Power Audio CODEC with DirectDrive Headphone Amplifiers

ELECTRICAL CHARACTERISTICS (continued)

($V_{AVDD} = V_{CPVDD} = V_{DVDD2} = V_{DVDD} = 1.8V$, $R_{HP} = 32\Omega$, $R_{LINE} = 10k\Omega$, $C_1 = 4.7\mu F$, $C_2 = 4.7\mu F$, $C_{REF} = C_{MBIAS} = C_{PREG} = C_{NREG} = 1\mu F$, $A_{VPRE} = +20dB$, $C_{MICBIAS} = 1\mu F$, $A_{VMIGPGA} = 0dB$, $f_{MCLK} = 11.2896MHz$, $DRATE = 00$, $T_A = T_{MIN}$ to T_{MAX} , unless otherwise noted. Typical values are at $T_A = +25^\circ C$.) (Note 1)

PARAMETER	SYMBOL	CONDITIONS	MIN	TYP	MAX	UNITS
LINEIN1/LINEIN2 INPUTS						
Line Input Full-Scale Input Voltage	0dBFS			2		V _{P-P}
Input DC Bias Voltage				0		V
Line Input Resistance	R_{IN}	PGA = 0dB (Note 9)	12	21		k Ω
Crosstalk		LINEIN1 to LINEIN2 or LINEIN2 to LINEIN1, f = 1kHz		97		dB
Line Channel-to-Channel Gain Matching	A_{VMATCH}			± 2		%
PGA Gain Range			-32		+30	dB
PGA Gain Step Size		-32dB to +30dB		2		dB
AUXIN INPUT						
AUXIN Full-Scale Input Voltage	0dBFS	AUXDC = 0		2		V _{P-P}
Input DC Voltage Range		AUXDC = 1	0		1	V
Input DC Bias Voltage		AUXDC = 0		0		V
AUXIN Input Resistance	R_{IN}	AUXDC = 0	12	21		k Ω
		AUXDC = 1		100		M Ω
Line Channel-to-Channel Gain Matching	A_{VMATCH}			± 2		%
PGA Gain Range			-32		+30	dB
PGA Gain Step Size		-32dB to +30dB		2		dB
JACK SENSE OPERATION (EN[2:0] = 000)						
JACKSNS High Threshold (JKMIC)	V_{TH1}	$T_A = +25^\circ C$	0.92 x $V_{MICBIAS}$	0.95 x $V_{MICBIAS}$	0.98 x $V_{MICBIAS}$	V
JACKSNS Deglitch Period (JKMIC)	t_{GLITCH}	Pulses shorter than t_{GLITCH} are eliminated		12		ms
JACKSNS Voltage (JKMIC)		JDETEN = 1		V_{AVDD}		V
HEADSET IMPEDANCE DETECT MODE (EN[2:0] = 111)						
JACKSNS/HPL/HPR High Threshold (JSDET/HSDETL/HSDETR)	V_{TH2}	HPL/HPR disabled	0.32	0.40	0.48	V
JACKSNS/HPL/HPR Low Threshold (JSDET/HSDETL/HSDETR)	V_{TH3}	HPL/HPR disabled	0.075	0.100	0.125	V
JACKSNS/HPL/HPR Sense Current (JSDET/HSDETL/HSDETR)	I_{SNS}	HPL/HPR disabled	1.7	2.0	2.3	mA

Low-Power Audio CODEC with DirectDrive Headphone Amplifiers

MAX9856

ELECTRICAL CHARACTERISTICS (continued)

($V_{AVDD} = V_{CPVDD} = V_{DVDDS2} = V_{DVDD} = 1.8V$, $R_{HP} = 32\Omega$, $R_{LINE} = 10k\Omega$, $C_1 = 4.7\mu F$, $C_2 = 4.7\mu F$, $C_{REF} = C_{MBIAS} = C_{PREG} = C_{NREG} = 1\mu F$, $A_{VPRE} = +20dB$, $C_{MICBIAS} = 1\mu F$, $A_{VMICPGA} = 0dB$, $MCLK = 11.2896MHz$, $DRATE = 00$, $T_A = T_{MIN}$ to T_{MAX} , unless otherwise noted. Typical values are at $T_A = +25^\circ C$.) (Note 1)

PARAMETER	SYMBOL	CONDITIONS	MIN	TYP	MAX	UNITS
SLEEP MODE (JDETEN = 1, SHDNB = 0)						
JACKSNS/HPL Resistance	R _{PU}	MICBIAS = GND	400	1000		k Ω
JACKSNS/HPL Sense Voltage	V _{PU}			V _{AVDD}		V
JACKSNS/HPL Sleep Threshold (JKSNS/LSNS)	V _{TH4}		V _{AVDD} - 0.8V	V _{AVDD} - 0.4V	V _{AVDD} - 0.15V	V

DIGITAL INTERFACE ELECTRICAL CHARACTERISTICS

($V_{DVDD} = V_{DVDDS2} = 1.8V$, $T_A = T_{MIN}$ to T_{MAX} , unless otherwise noted.) (Note 1)

PARAMETER	SYMBOL	CONDITIONS	MIN	TYP	MAX	UNITS
MCLK INPUT CHARACTERISTICS						
Input Voltage High	V _{IH}		0.7 x V _{DVDD}			V
Input Voltage Low	V _{IL}				0.4	V
Input Leakage Current	I _{IH} , I _{IL}		-10		+10	μA
Input Capacitance				3		pF
MCLK Input Frequency			10		60	MHz
MCLK Duty Cycle			40	50	60	%
Maximum MCLK Input Jitter		For guaranteed performance limits		100		psRMS
DIGITAL INPUTS (BCLK, LRCLK_A, LRCLK_D, SDIN, SDA, SCL)						
Input Voltage High	V _{IH}		0.7 x V _{DVDD}			V
Input Voltage Low	V _{IL}			0.3 x V _{DVDD}		V
Input Hysteresis				200		mV
Input Leakage Current	I _{IH} , I _{IL}		-10		+10	μA
Input Capacitance				10		pF
CMOS DIGITAL OUTPUTS (BCLK, LRCLK_A, LRCLK_D, SDOUT)						
Output Low Voltage	V _{OL}	I _{OL} = 3mA			0.4	V
Output High Voltage	V _{OH}	I _{OH} = 3mA	V _{DVDD} - 0.4			V
OPEN-DRAIN DIGITAL OUTPUTS (IRQ, SDA)						
Output High Current	I _{OH}	V _{OUT} = V _{DVDD}			1	μA
Output Low Voltage	V _{OL}	I _{OL} = 3mA			0.4	V
DIGITAL AUDIO INTERFACE TIMING CHARACTERISTICS						
BCLK Cycle Time	t _{BCLKS}	Slave operation	75			ns
	t _{BCLKM}	Master operation	100	325		ns
BCLK High Time	t _{BCLKH}	Slave operation	30			ns
BCLK Low Time	t _{BCLKL}	Master operation	30			ns
BCLK or LRCLK_A/D Rise and Fall Time	t _r , t _f	Master operation, C _L = 15pF	7			ns

Low-Power Audio CODEC with DirectDrive Headphone Amplifiers

DIGITAL INTERFACE ELECTRICAL CHARACTERISTICS (continued)

($V_{DVDD} = V_{DVDD2} = 1.8V$, $T_A = T_{MIN}$ to T_{MAX} , unless otherwise noted.) (Note 1)

PARAMETER	SYMBOL	CONDITIONS	MIN	TYP	MAX	UNITS
SDIN or LRCLK_A/D to BCLK Rising Setup Time	t_{SU}	BCI = 0 (see the <i>I²C Register Address Map and Definitions</i> section)	30			ns
SDIN or LRCLK_A/D to BCLK Rising Hold Time	t_{HD}	BCI = 0 (see the <i>I²C Register Address Map and Definitions</i> section)	5			ns
SDOUT Delay Time	t_{DLY}	BCI = 0 (see the <i>I²C Register Address Map and Definitions</i> section), $C_L = 30pF$	0		50	ns
I²C INTERFACE TIMING CHARACTERISTICS						
Serial-Clock Frequency	f_{SCL}		0		400	kHz
Bus Free Time Between STOP and START Conditions	t_{BUF}		1.3			μs
Hold Time (Repeated) START Condition	$t_{HD,STA}$		0.6			μs
SCL Pulse Width Low	t_{LOW}		1.3			μs
SCL Pulse Width High	t_{HIGH}		0.6			μs
Setup Time for a Repeated START Condition	$t_{SU,STA}$		0.6			μs
Data Hold Time	$t_{HD,DAT}$		0		900	ns
Data Setup Time	$t_{SU,DAT}$		100			ns
SDA and SCL Receiving Rise Time	t_r	(Note 10)	$20 + 0.1C_B$		300	ns
SDA and SCL Receiving Fall Time	t_f	(Note 10)	$20 + 0.1C_B$		300	ns
SDA Transmitting Fall Time	t_f	$V_{DVDD} = 1.8V$ (Note 10)	$20 + 0.1C_B$		250	ns
		$V_{DVDD} = 3.6V$ (Note 10)	$20 + 0.05C_B$		250	
Setup Time for STOP Condition	$t_{SU,STO}$		0.6			μs
Bus Capacitance	C_b				400	pF
Pulse Width of Suppressed Spike	t_{SP}	$T_A = +25^\circ C$	0		50	ns

Note 1: All devices are 100% production tested at room temperature. All temperature limits are guaranteed by design.

Note 2: Supply current measurements taken with no applied input signal to line and microphone inputs. A digital zero audio signal used for all digital serial audio inputs. Speaker and headphone outputs are loaded as stated in the global conditions.

Note 3: DAC performance measured at headphone outputs.

Note 4: Dynamic range measured using the EIAJ method. The input is applied at -60dBFS, $f_{IN} = 1kHz$. The is THD+N referred to 0dBFS.

Note 5: Signal-to-noise ratio measured using an all-zeros input signal, and is relative to 0dB full scale. The DAC is not muted for the SNR measurement.

Note 6: Performance measured from line inputs (unless otherwise noted).

Note 7: Microphone amplifiers connected to ADC, microphone inputs AC-grounded.

Note 8: In master-mode operation, the accuracy of the MCLK input proportionally determines the accuracy of the sample clock rate. ($V_{DVDD} = 1.8V$, unless otherwise noted).

Note 9: To enable the line input, make sure the desired input is selected by either the audio output mixer or the ADC input mixer.

Note 10: C_B is in pF.

Low-Power Audio CODEC with DirectDrive Headphone Amplifiers

Typical Operating Characteristics

($V_{AVDD} = V_{CPVDD} = V_{DVDD2} = V_{DVDD} = 1.8V$, $R_{HP} = 32\Omega$, $R_{LINE} = 10k\Omega$, $C_1 = 4.7\mu F$, $C_2 = 4.7\mu F$, $C_{REF} = C_{BIAS} = C_{PREG} = C_{NREG} = 1\mu F$, $V_{AVPRE} = +20dB$, $C_{MICBIAS} = 1\mu F$, $V_{AVMICPGA} = 0dB$, $f_{MCLK} = 12.288MHz$, $DRATE = 10$, $T_A = +25^\circ C$, unless otherwise noted.)

MAX9856

TOTAL HARMONIC DISTORTION PLUS NOISE vs. OUTPUT POWER (DAC TO HP)

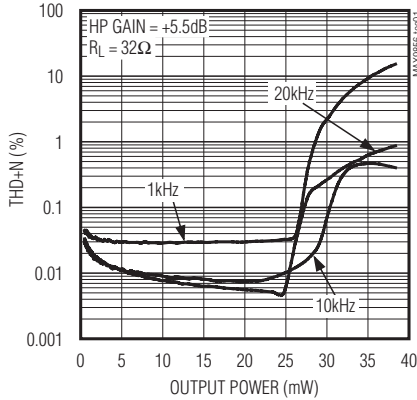

TOTAL HARMONIC DISTORTION PLUS NOISE vs. OUTPUT POWER (DAC TO HP)

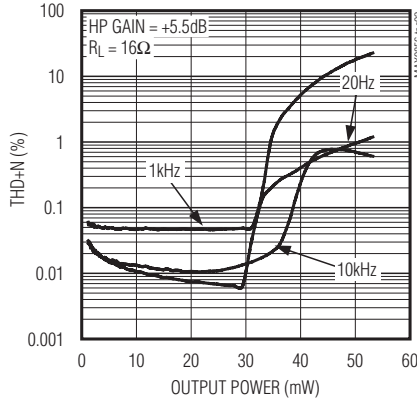

TOTAL HARMONIC DISTORTION + NOISE vs. FREQUENCY (DAC TO HP)

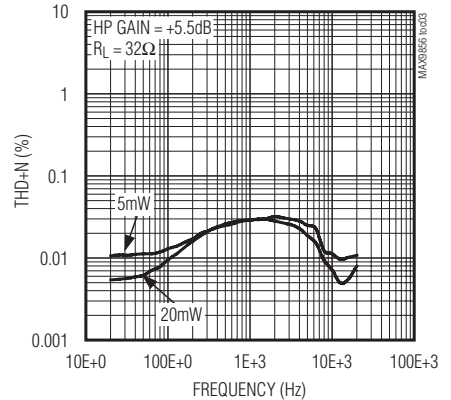

TOTAL HARMONIC DISTORTION + NOISE vs. FREQUENCY (DAC TO HP)

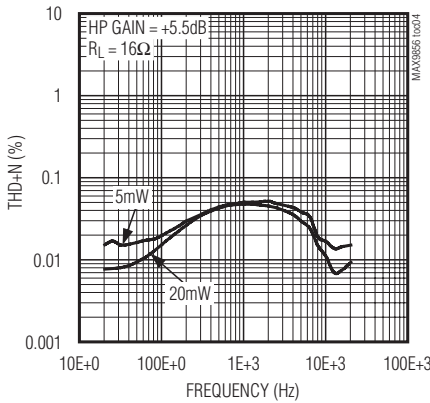

TOTAL HARMONIC DISTORTION + NOISE vs. FREQUENCY (DAC TO LINE OUT)

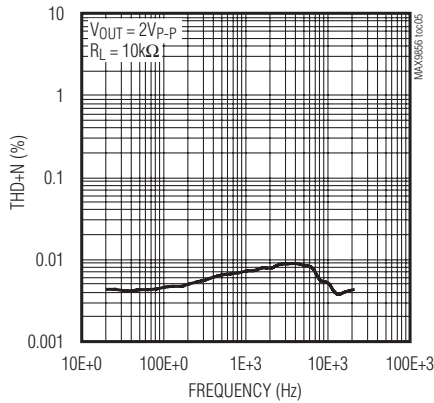

TOTAL HARMONIC DISTORTION PLUS NOISE vs. FREQUENCY (LINE IN TO ADC)

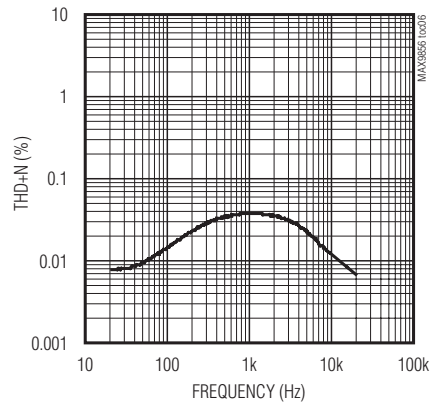

TOTAL HARMONIC DISTORTION PLUS NOISE vs. FREQUENCY (INTMIC TO ADC)

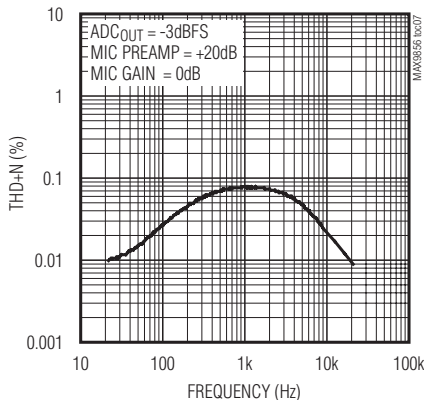

TOTAL HARMONIC DISTORTION PLUS NOISE vs. FREQUENCY (INTMIC TO ADC)

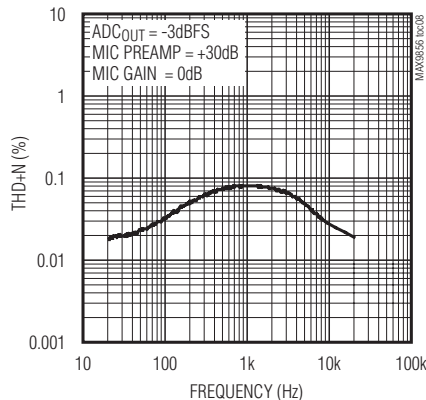

POWER OUT vs. HEADPHONE LOAD

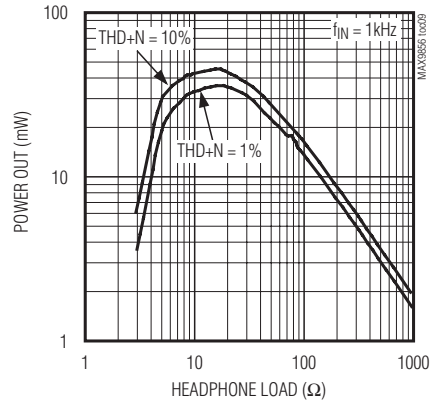

Low-Power Audio CODEC with DirectDrive Headphone Amplifiers

Typical Operating Characteristics (continued)

($V_{AVDD} = V_{CPVDD} = V_{DVDD2} = V_{DVDD} = 1.8V$, $R_{HP} = 32\Omega$, $R_{LINE} = 10k\Omega$, $C_1 = 4.7\mu F$, $C_2 = 4.7\mu F$, $C_{REF} = C_{MBIAS} = C_{PREG} = C_{NREG} = 1\mu F$, $V_{AVPRE} = +20dB$, $C_{MICBIAS} = 1\mu F$, $V_{AVMICPGA} = 0dB$, $f_{MCLK} = 12.288MHz$, $DRATE = 10$, $T_A = +25^\circ C$, unless otherwise noted.)

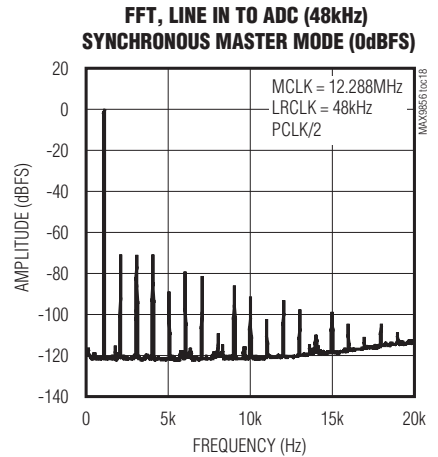
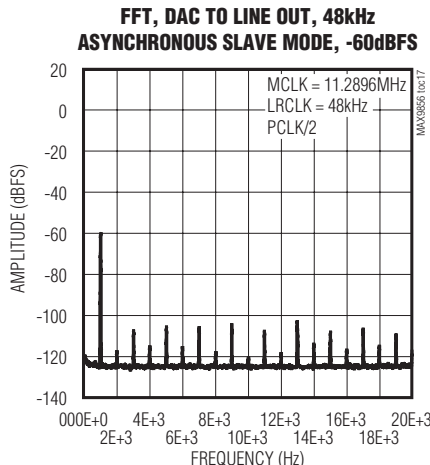
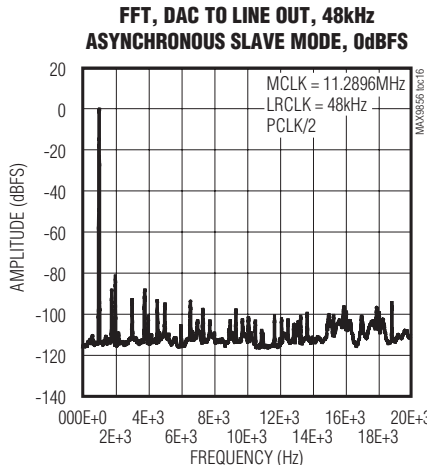
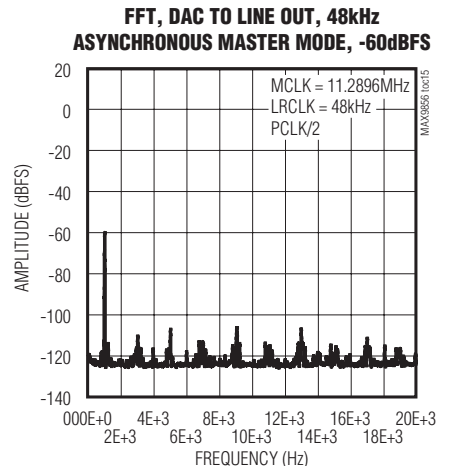
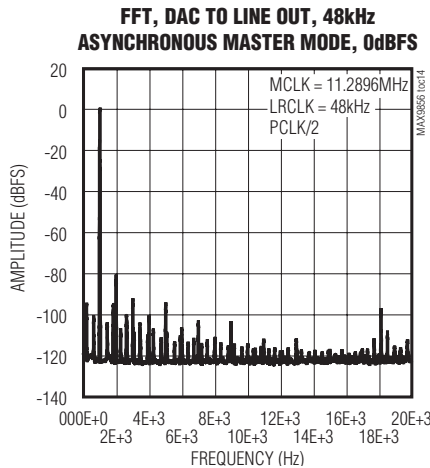
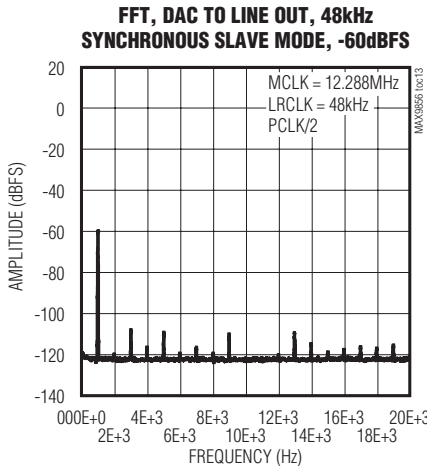
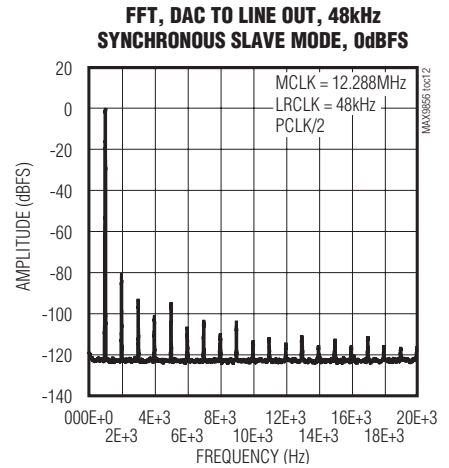
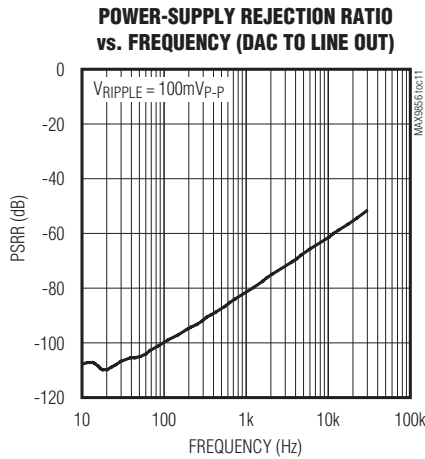
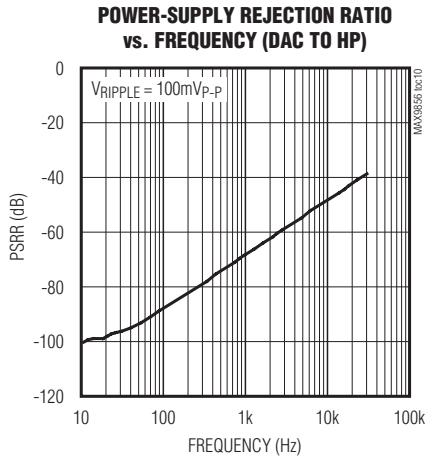

Low-Power Audio CODEC with DirectDrive Headphone Amplifiers

MAX9856

Typical Operating Characteristics (continued)

($V_{AVDD} = V_{CPVDD} = V_{DVDD2} = V_{DVDD} = 1.8V$, $R_{HP} = 32\Omega$, $R_{LINE} = 10k\Omega$, $C1 = 4.7\mu F$, $C2 = 4.7\mu F$, $C_{REF} = C_{MBIAS} = C_{PREG} = C_{NREG} = 1\mu F$, $V_{AVPRE} = +20dB$, $C_{MICBIAS} = 1\mu F$, $V_{AVMICPGA} = 0dB$, $f_{MCLK} = 12.288MHz$, $DRATE = 10$, $T_A = +25^\circ C$, unless otherwise noted.)

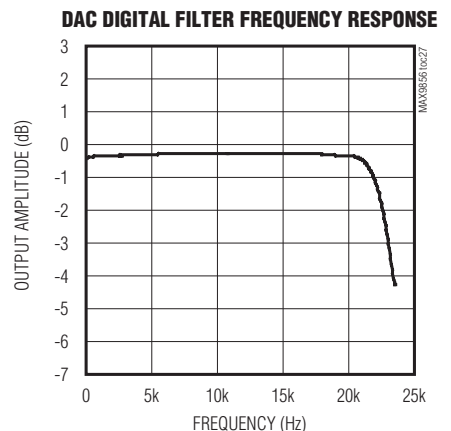
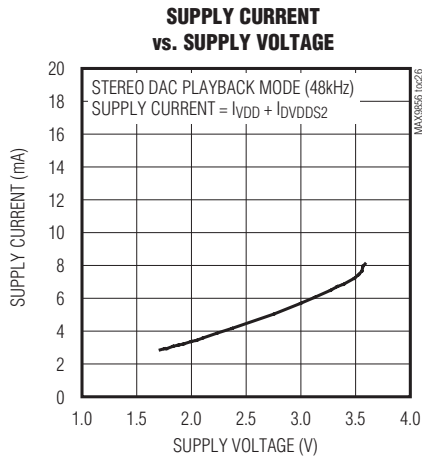
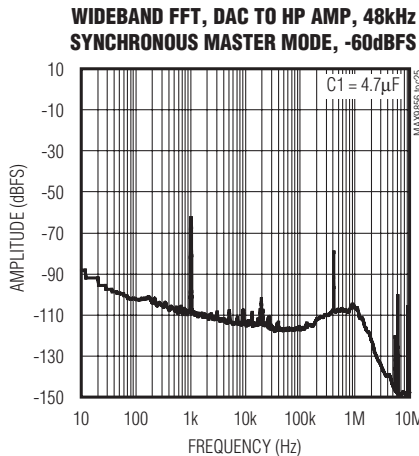
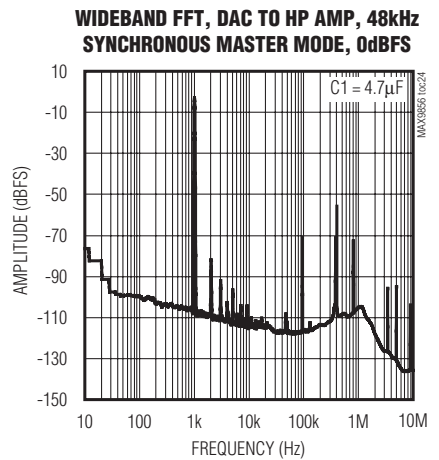
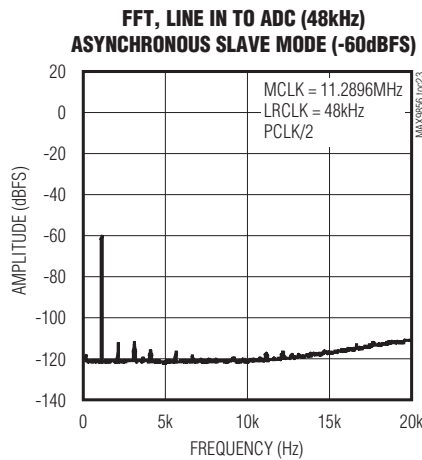
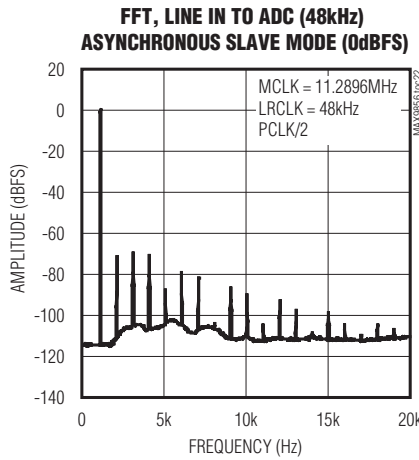
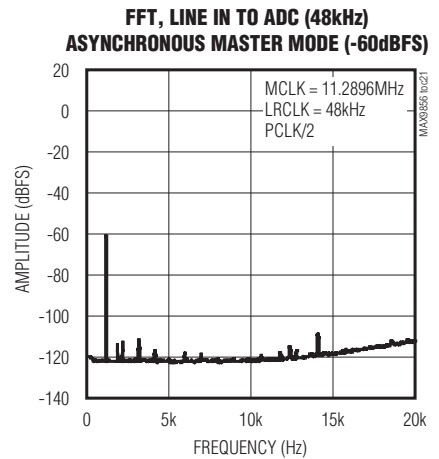
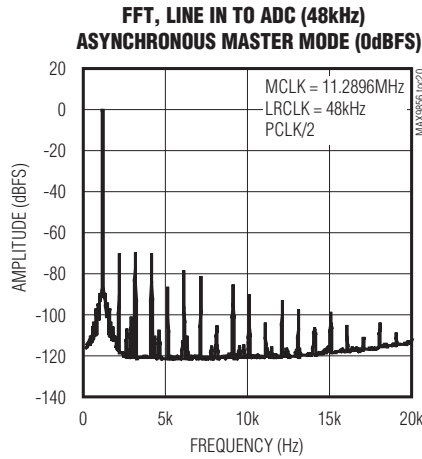
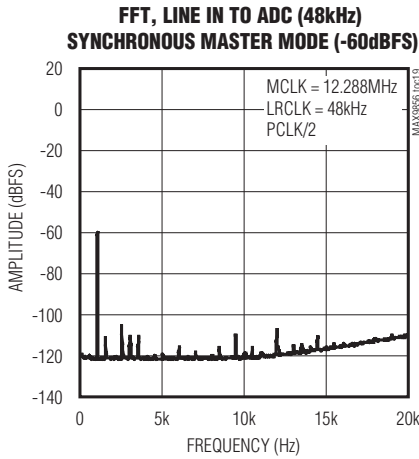

Low-Power Audio CODEC with DirectDrive Headphone Amplifiers

Typical Operating Characteristics (continued)

($V_{AVDD} = V_{CPVDD} = V_{DVDD2} = V_{DVDD} = 1.8V$, $R_{HP} = 32\Omega$, $R_{LINE} = 10k\Omega$, $C_1 = 4.7\mu F$, $C_2 = 4.7\mu F$, $C_{REF} = C_{MBIAS} = C_{PREG} = C_{NREG} = 1\mu F$, $V_{AVPRE} = +20dB$, $C_{MICBIAS} = 1\mu F$, $V_{AVMICPGA} = 0dB$, $f_{MCLK} = 12.288MHz$, $DRATE = 10$, $T_A = +25^\circ C$, unless otherwise noted.)

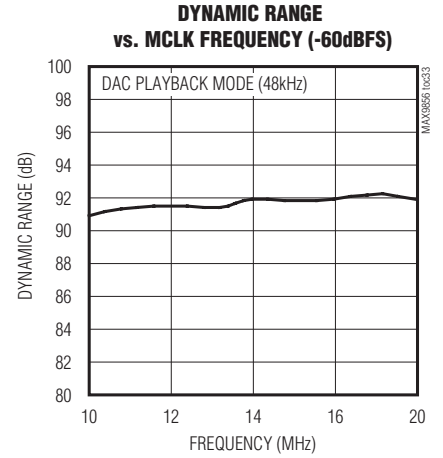
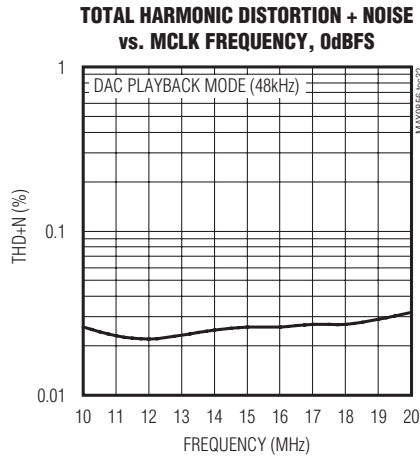
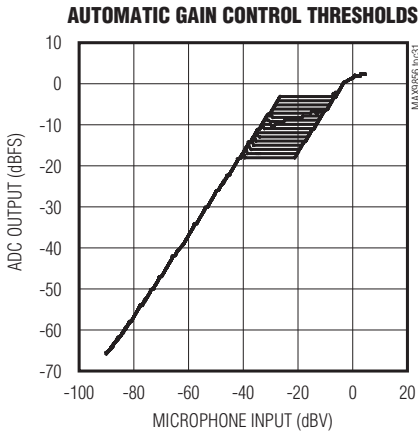
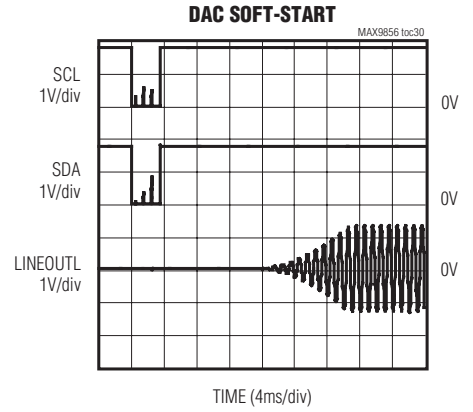
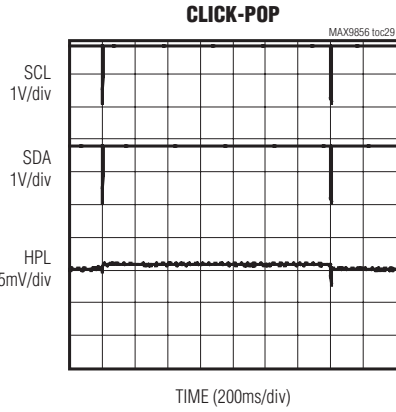
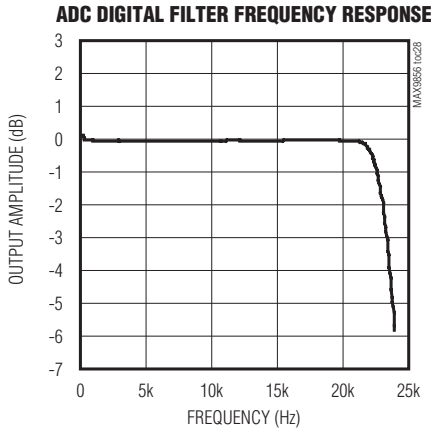

Low-Power Audio CODEC with DirectDrive Headphone Amplifiers

Pin Description

MAX9856

PIN	NAME	FUNCTION
1	LINEIN1	Line 1 Input. AC-couple signal to LINEIN1 with a 1 μ F capacitor.
2	LINEIN2	Line 2 Input. AC-couple signal to LINEIN2 with a 1 μ F capacitor.
3	AUXIN	Auxiliary Input. Input for beep and sound effect signals or can be used for DC measurements.
4	PREG	Positive Internally Regulated Supply (+1.6V \pm 5%). Bypass to AGND with 1 μ F capacitor.
5	NREG	Negative Internally Regulated Supply (-1.15V \pm 5%). Bypass to AGND with 1 μ F capacitor.
6	MBIAS	Internal Microphone Bias Regulator Output (1.23V \pm 5%). Bypass to AGND with a 1 μ F capacitor.
7	REF	Converter Reference (1.23V \pm 5%). Bypass to AGND with a 1 μ F capacitor.
8	LGNDSENS	Line Output Ground Sense. Feedback path to line-out amplifiers for noise reduction. Connect to the ground pin of the line output jack. Connect directly to AGND, if ground sense is not required.
9	LOUTL	Left-Channel Line Output. Ground-referenced DirectDrive output.
10	LOUTR	Right-Channel Line Output. Ground-referenced DirectDrive output.
11	HGNDSENS	Headphone Ground Sense. Feedback path to headphone amplifiers for noise reduction. Connect to the ground pin of the headphone jack. Connect directly to AGND if ground sense is not required.
12	AVDD	Analog Power Supply. Bypass to AGND with 10 μ F and 0.1 μ F capacitors.
13	HPL	Left Headphone DirectDrive Output
14	HPR	Right Headphone DirectDrive Output
15	SVSS	Negative Power-Supply Input. Connect to PVSS and bypass to CPGND with a 4.7 μ F capacitor.
16	PVSS	Internally Generated Negative Supply. Connect to SVSS.
17	C1N	Charge-Pump Flying Capacitor Negative Terminal. Connect a 4.7 μ F capacitor between C1N and C1P.
18	CPGND	Charge-Pump Ground
19	C1P	Charge-Pump Flying Capacitor Positive Terminal. Connect a 4.7 μ F capacitor between C1P and C1N.
20	CPVDD	Charge-Pump Positive Supply. Bypass to CPGND with a 4.7 μ F capacitor.
21	SCL	I ² C Serial-Clock Input. Connect a 10k Ω pullup resistor to DVDD.
22	SDA	I ² C Serial-Data Input/Output. Connect a 10k Ω pullup resistor to DVDD.
23	$\overline{\text{IRQ}}$	Hardware Interrupt Output. $\overline{\text{IRQ}}$ can be programmed to pull low when bits in the status register 0x00 change state. Read status register 0x00 to clear $\overline{\text{IRQ}}$ once set. Repeat faults have no effect on $\overline{\text{IRQ}}$ until it is cleared by reading the I ² C status register 0x00. Connect a 10k Ω pullup resistor to DVDD for full output swing.
24	LRCLK_D	Digital Audio Left-Right Clock Input/Output. LRCLK_D is the audio sample rate clock that determines whether the audio data on SDIN is routed to the left or right channel. LRCLK_D is an input when the MAX9856 is in slave mode and an output when in master mode. LRCLK_D is also used with SDOUT if LRCLK_A is configured as a GPIO.

Low-Power Audio CODEC with DirectDrive Headphone Amplifiers

Pin Description (continued)

PIN	NAME	FUNCTION
25	BCLK	Digital Audio Bit Clock Input/Output. BCLK is an input when the MAX9856 is in slave mode and an output when in master mode.
26	SDOUT	Digital Audio Serial Data ADC Output
27	SDIN	Digital Audio Serial Data DAC Input
28	DVDDS2	Digital Audio Interface I/O Power Supply. Bypass to DGND with 1 μ F capacitor.
29	LRCLK_A	Digital Audio Left-Right Clock Input/Output. LRCLK_A is the audio sample rate clock that determines whether the audio data on SDOUT is routed to the left or right channel. When only one LRCLK is needed (ADC and DAC are at the same sample rate), LRCLK_A can be reprogrammed as a general-purpose input/output, GPIO.
30	MCLK	Master Clock Input (CMOS Input). Acceptable Input frequency range: 10MHz to 60MHz.
31	DVDD	Digital Power Supply. Supply for the digital core and I ² C interface. Bypass to DGND with a 1.0 μ F capacitor.
32	DGND	Digital Ground
33	INLN	Inverting Left Differential Input. AC-couple to the low side of microphone, or connect to the negative line signal. AC-couple to ground when using with a single-ended line or microphone input.
34	INLP	Noninverting Left Differential Input. AC-couple to the high side of microphone, or connect to the positive line signal. AC-couple to the signal when using with a single-ended line or microphone input.
35	MICL	Left-Channel Single-Ended Microphone Input. AC-couple to the microphone with a 1 μ F capacitor.
36	MICGND	Microphone Ground. Allows the common return signal of a stereo microphone pair to be connected to the inverting input differential amps in a pseudo differential configuration. Alternatively MICGND can be grounded for single-ended microphone applications.
37	MICR	Right-Channel Single-Ended Microphone Input. AC-couple to the microphone with a 1 μ F capacitor.
38	MICBIAS	Low-Noise Bias Voltage. Outputs a 1.5V or 2.4V microphone bias. An external resistor in the 2.2k Ω to 470 Ω range should be used to set the microphone current.
39	AGND	Analog Ground (and Chip Substrate)
40	JACKSNS	Jack Sense. Detects the presence or absence of a jack, and can be configured to detect the impedance range of the external load. See the <i>Headset Detection</i> section.
—	EP	Exposed Pad. The exposed pad lowers the package's thermal impedance by providing a direct heat conduction path from the die to the PCB. The exposed pad is internally connected to the substrate. Connect the exposed thermal pad to AGND.

Low-Power Audio CODEC with DirectDrive Headphone Amplifiers

Functional Diagram

MAX9856

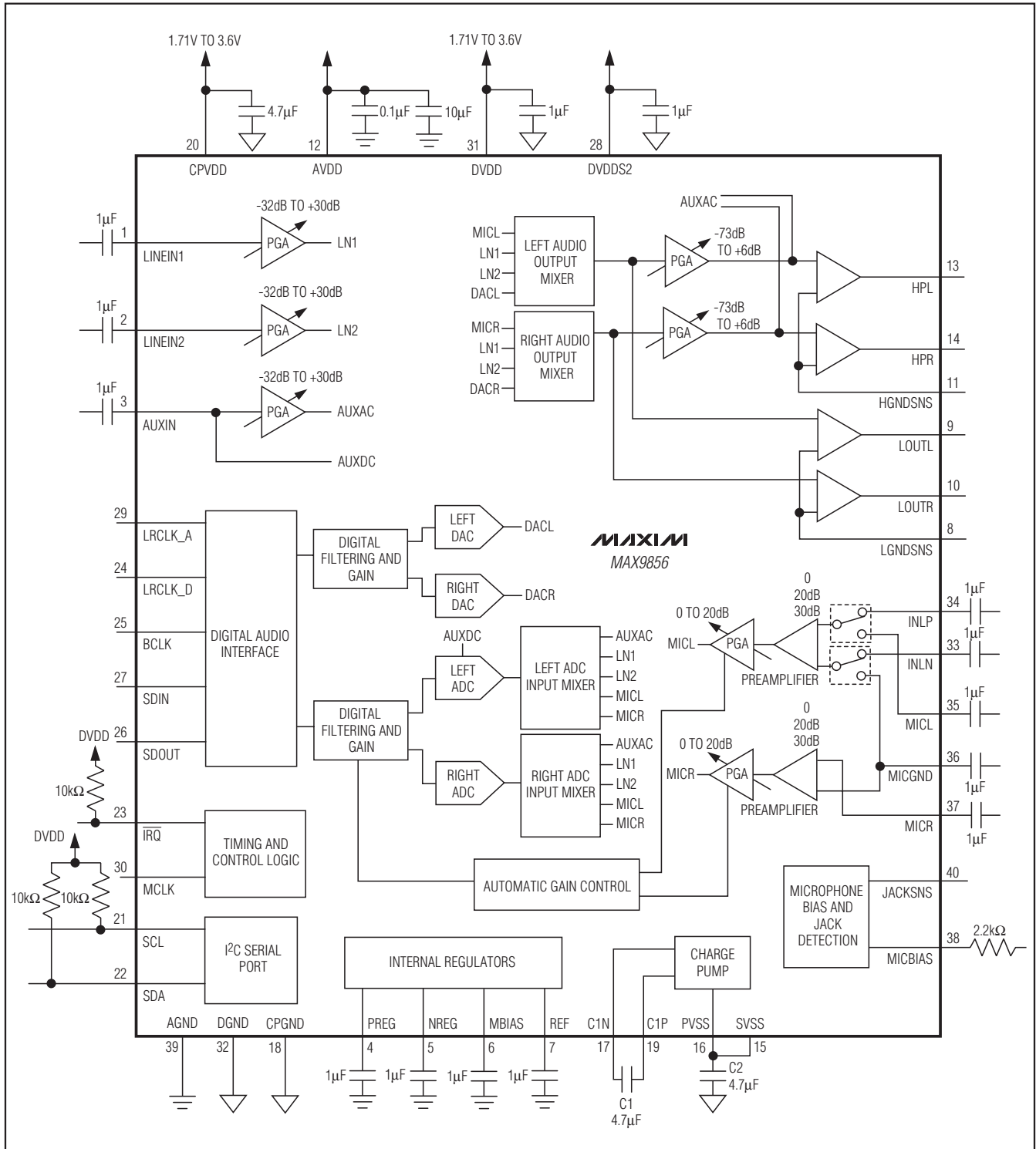

Low-Power Audio CODEC with DirectDrive Headphone Amplifiers

Detailed Description

The MAX9856 is a high-performance, low-power stereo audio CODEC designed to provide a complete audio solution. Operating from a 1.8V supply, the MAX9856 achieves high performance and reasonable output power while consuming only 9mW in DAC playback mode.

The internal 18-bit sigma-delta DAC accepts stereo digital audio signals, and converts them to stereo audio outputs that can be mixed with line inputs and/or microphone inputs. The DAC is capable of operating at sample rates ranging from 8kHz to 96kHz with any master clock frequency between 10MHz and 60MHz. The DAC is capable of operating at a different sample rate than the ADC. Both master and slave modes are available when operating the interface in left-justified, I²S or PCM data format. The incoming data can be level shifted and highpass filtered in the digital domain. The highpass filtering allows only reproducible frequencies to be converted, saving power and improving sound quality.

The MAX9856 features stereo DirectDrive headphone amplifiers and line outputs, which eliminate the need for large output-coupling capacitors. The audio output path includes high-quality mixing amplifiers to allow flexibility in choosing from the DAC output and the stereo analog line inputs. Volume control amplifiers provide adjustable gains between +5.5dB and -74dB for the headphones. The line outputs are capable of generating a 1VRMS output signal from a full-scale digital input.

The digital audio signals of the internal 18-bit sigma-delta ADC outputs are converted from the analog microphone and line input paths. The ADC is capable of operating at a sample rate ranging from 8kHz to 48kHz with any master clock frequency between 10MHz and 60MHz. The ADC is capable of operating at a different sample rate than the DAC. Both master and slave modes are available when operating the interface in left-justified, I²S, or PCM data formats. The outgoing data can be level shifted and highpass filtered in the digital

domain. The highpass filtering allows reduction of wind noise from microphone inputs.

Three microphone inputs are available. One fully differential input can be used with internal microphones while a pair of single-ended inputs can be used with an external mono or stereo headset microphone. Selectable gain of 0dB, 20dB, and 30dB can be applied to the input signals in addition to a 0 to 20dB input PGA. The MAX9856 features AGC on the microphone input path to automatically compensate for varying input signal levels and the limited dynamic range of most microphones. The integrated noise gate provides low-level audio noise quieting to lower the audible noise floor.

An auxiliary input is available for sending externally generated beeps and sound effects directly to the headphones. The auxiliary input can also be used to make DC measurements with the ADC by providing a direct path to the ADC.

HPL, HPR, and JACKSNS provide a headset detection feature which can both detect the insertion of a jack and measure the load impedance. Jack detection can be done in both shutdown and powered-on mode. The headphone and line outputs feature ground sensing to reduce ground noise. Reduced output offset voltage and extensive click-and-pop suppression circuitry on headphone amplifiers eliminate audible clicks and pops at startup and shutdown

I²C Register Address Map and Definitions

The MAX9856 has 28 internal registers used for configuration and status reporting. Table 1 lists all the registers, their addresses, and power-on-reset (POR) states. Registers 0x00 and 0x01 are read only, while all the other registers are read/write. Write zeros to all unused bits in the register table when updating the register, unless otherwise noted.

Low-Power Audio CODEC with DirectDrive Headphone Amplifiers

MAX9856

Table 1. Register Map

REGISTER	B7	B6	B5	B4	B3	B2	B1	B0	REGISTER ADDRESS	POWER-ON RESET STATE
Status	CLD	SLD	ULK	JKMIC	HPOCL	HPOCR	JDET	GPI	0x00	—
Status	LSNS	JKSNS	HSDCTL		HSDETR		JSDET		0x01	—
Interrupt Enable	ICLD	ISLD	IULK	0	IHPOCL	IHPOCR	IJDET	IGPI	0x02	0x00
CLOCK CONTROL										
Clock Rates	0	PSCLK			MAS	BSEL			0x03	0x00
DAC INTERFACE										
System	DWCI	DBC1	DRATE		DDLY	PCM	DHF	WS	0x04	
Interface	DPLEN	DACNI[14:8]							0x05	0x00
Interface	DACNI[7:0]							0x06	0x00	
ADC INTERFACE										
System	AWCI	ABC1	APIN		ADLY	0	0	0	0x07	0x00
Interface	APLEN	ADCNI[14:8]							0x08	0x00
Interface	ADCNI[7:0]							0x09	0x00	
Level	AGAIN				ANTH				0x0A	0x00
DIGITAL FILTERS										
Highpass Filters	0	ADCHP			0	DACHP			0x0B	0x00
AUTOMATIC GAIN CONTROL										
AGC Control	0	AGCRLS			AGCATK		AGCHLD		0x0C	0x00
AGC Threshold	0	0	0	AGCSRC	AGCSTH				0x0D	0x00
ANALOG MIXERS										
ADC Mixer	0	0	0	MXINL				0x0E	0x00	
ADC Mixer	0	0	0	MXINR				0x0F	0x00	
Output Mixer	MXOUTL				MXOUTR				0x10	0x00
AUDIO INPUTS										
Digital Input Gain	PGADS							0x11	0x00	
AUXIN Gain	0	0	0	PGAAUX				0x12	0x00	
LINEIN1 Gain	0	0	0	PGAL1				0x13	0x00	
LINEIN2 Gain	0	0	0	PGAL2				0x14	0x00	
MICL Gain	0	PAENL			PGAML				0x15	0x00
MICR Gain	0	PAENR			PGAMR				0x16	0x00
MIC Mode	0	0	0	0	MMIC	MBSSEL	0	LMICDIF	0x17	0x00
AUDIO OUTPUTS										
HPL Volume	0	HPMUTE	HPVOLL				0x18	0x00		
HPR Volume	0	0	HPVOLR				0x19	0x00		
Output Mode	0	VSEN	AUXDC	AUXMIX	0	0	HPMODE		0x1A	0x00
HEADSET DETECT										
System	0	0	0	0	JDETEN	EN			0x1B	0x00
POWER MANAGEMENT										
System	SHDN	0	DIGEN	LOUTEN	DALEN	DAREN	ADLEN	ADREN	0x1C	0x00

Low-Power Audio CODEC with DirectDrive Headphone Amplifiers

Status Registers

Status registers 0x00 and 0x01 are read-only registers that report the status of various device functions. The status register bits are cleared upon a read operation of

the status register and are set the next time the event occurs. Table 2 lists the status registers bit location and description.

Table 2. Status Registers Bit Location

REG	B7	B6	B5	B4	B3	B2	B1	B0
0x00	CLD	SLD	ULK	JKMIC	HPOCL	HPOCR	JDET	GPI
0x01	LSNS	JKSNS	HSDCTL		HSDETR		JSDDET	

Status Register Bit Description

BIT	FUNCTION	
CLD	Clip Detect Flag. Indicates that a signal has become clipped in the ADC.	
SLD	Slew-Level Detect Flag. When volume or gain changes are made, the slewing circuitry smoothly steps through all intermediate settings. When SLD is set high, all slewing has completed and the volume or gain is at its final value.	
ULK	Digital PLL Unlock Flag. Indicates that the digital audio PLL for the DAC or ADC has become unlocked and digital signal data is not reliable.	
JKMIC	Jack Microphone Flag. Indicates JACKSNS has been pulled up to the MICBIAS voltage. The microphone bias must be enabled for this bit to function properly.	
HPOCL/ HPOCR	Headphone Output Left/Right Current Overload Flags. Indicate that the headphone output amplifiers have exceeded the rated current.	
JDET	Headset Configuration Change Flag. Indicates a change in JKMIC, LSNS, or JKSNS.	
GPI	GPI State. Indicates the state of LRCLK_A when configured as a general-purpose input.	
LSNS	Headphone Sense. LSNS is set when the internal pullup current forces the voltage at HPL to exceed AVDD - 0.4V. This indicates headphone jack insertion or removal has occurred. HPMODE must be set to 00 and JDETEN set to 1 for this bit to function.	
JKSNS	Jack Sense. JKSNS is set when the internal pullup current forces the voltage on JACKSNS to exceed AVDD - 0.4V. This indicates jack insertion or removal has occurred. JDETEN must be set for this bit to function.	
HSDCTL, HSDETR, JSDDET	Load Impedance Sense. Indicates the approximate load connected to HPR, HPL, or JACKSNS. These bits are updated once each time the appropriate EN bits are set high and cause an undefeatable hardware interrupt.	
	BITS	HEADPHONE OR JACKSNS LOAD
	00	200Ω < load < open
	01	50Ω < load < 200Ω
	10	0 < load < 50Ω
	11	Idle state

Low-Power Audio CODEC with DirectDrive Headphone Amplifiers

Interrupt Enables

Hardware interrupts are reported on the open-drain \overline{IRQ} pin. When an interrupt occurs, \overline{IRQ} remains low until the interrupt is serviced by reading status register 0x00. If a flag is set, it is reported as a hardware interrupt only if

the corresponding interrupt enable is set. Each bit enables interrupts for the status flag in the respective bit location in register 0x00. Table 3 lists the interrupt enable bit locations and description.

Table 3. Interrupt Enable Bit Locations

REG	B7	B6	B5	B4	B3	B2	B1	B0
0x02	ICLD	ISLD	IULK	0	IHPOCL	IHPOCR	IJDET	IGPI

Clock Control

The MAX9856 can work with a master clock supplied from any system clock (MCLK) within the range of 10MHz to 60MHz range. A clock prescaler divides by 1, 2, or 4 to create an internal clock (PCLK) in the 10MHz to 20MHz range.

There are two clock-generation circuits that operate independently for the ADC and DAC path, allowing the ADC and DAC to be operated at different sample rates. BCLK services the LRCLK signals for both the ADC and

DAC. When the ADC and DAC operate at different LRCLK rates, BCLK should be set appropriately for the higher sample rate. The number of clock cycles per frame must be greater than or equal to the configured bit depth.

The MAX9856 digital audio interface can operate in either master or slave mode. In master mode, the MAX9856 generates the BCLK and LRCLK signals, which control the data flow on the digital audio interface. In slave mode, the external master device generates the BCLK and LRCLK signals. See Table 4.

Table 4. Clock Control Register

REG	B7	B6	B5	B4	B3	B2	B1	B0
0x03	0	PSCLK			MAS	BSEL		

Clock Control Register Bit Description

BITS	FUNCTION
PSCLK	MCLK Prescaler. Set PSCLK to appropriately divide down MCLK to a usable frequency: 000—Disable clock input 001—10MHz ≤ MCLK ≤ 16MHz (PCLK = MCLK/1) 010—16MHz ≤ MCLK ≤ 20MHz (PCLK = MCLK/1) 011—20MHz ≤ MCLK ≤ 32MHz (PCLK = MCLK/2) 100—32MHz ≤ MCLK ≤ 40MHz (PCLK = MCLK/2) 101—40MHz ≤ MCLK ≤ 60MHz (PCLK = MCLK/4) 110—Reserved 111—Reserved
MAS	Master Mode. Selects between master and slave operation: 0 = Slave mode (BCLK, LRCLK_D, and LRCLK_A are inputs) 1 = Master mode (BCLK, LRCLK_D, and LRCLK_A are outputs)
BSEL	BCLK Select. Configures BCLK when operating in master mode. Set BSEL to be a sufficiently high frequency to fully clock in all data bits for both the DAC and ADC, if operating at different sample rates: 000—Off 001—Off 010—BCLK = 48 x LRCLK_D (recommended if the DAC and ADC operate at the same rate) 011—BCLK = 48 x LRCLK_A 100—BCLK = PCLK/2 (recommended if the DAC and ADC are not operating at the same rate) 101—BCLK = PCLK/4 110—BCLK = PCLK/8 111—BCLK = PCLK/16

Low-Power Audio CODEC with DirectDrive Headphone Amplifiers

DAC Interface

The MAX9856 DAC is capable of supporting any sample rate from 8kHz to 96kHz in either master or slave mode, including all common sample rates (8kHz, 11.025kHz, 12kHz, 16kHz, 22.05kHz, 24kHz, 32kHz, 44.1kHz, 48kHz, 88.2kHz and 96kHz).

A 15-bit clock divider coefficient must be programmed into the device to set the DAC sample rate relative to the prescaled MCLK input (PCLK). This allows high flexibility in both the MCLK and LRCLK_D frequencies. In slave mode, the interface accepts any LRCLK_D signal between 7.8kHz to 100kHz.

There are two speed settings for the DAC set by the DRATE control bits. The highest rate runs the modulator at an internal clock rate between 5MHz and 10MHz, and provides the highest audio performance. The low rate runs the modulator between 2.5MHz and 5MHz for reduced power consumption.

The digital audio interface offers full functionality for several digital audio formats including left-justified, I²S, and PCM modes (Figure 1). Figure 2 shows the digital timing for various modes. Table 5 shows the DAC interface registers and descriptions. Table 6 lists the common DACNI and ADCNI values.

Table 5. DAC Interface Registers

REG	B7	B6	B5	B4	B3	B2	B1	B0
0x04	DWCI	DBCI	DRATE		DDLY	PCM	DHF	WS
0x05	DPLEN	DACNI[14:8]						
0x06	DACNI[7:0]							

DAC Interface Register Bit Descriptions

REGISTER	FUNCTION
DWCI	DAC Word Clock (LRCLK_D) Invert When PCM = 0: 0—Left-channel data is transmitted while LRCLK_D is low. 1—Right-channel data is transmitted while LRCLK_D is low. When PCM = 1: 0—Start of a new frame is signified by the falling edge of the LRCLK_D pulse. 1—Start of a new frame is signified by the rising edge of the LRCLK_D pulse.
DBCI	DAC BCLK Invert: 0—SDIN is accepted on the rising edge of BCLK. 1—SDIN is accepted on the falling edge of BCLK. In master mode: 0—LRCLK_D transitions occur on the falling edge of BCLK. 1—LRCLK_D transitions occur on the rising edge of BCLK.
DRATE	DAC Modulator Rate: 00—Low-power mode 01—Reserved 10—High-performance mode 11—DAC clock disabled
DDLY	DAC Data Delay: 0—The most significant bit of an audio word is latched at the first BCLK edge after the LRCLK_D transition. 1—The most significant bit of an audio word is latched at the second BCLK edge after the LRCLK_D transition. (DDLY = 1 for I ² S-compatible mode)

Low-Power Audio CODEC with DirectDrive Headphone Amplifiers

MAX9856

DAC Interface Register Bit Descriptions (continued)

REGISTER	FUNCTION
PCM	<p>PCM Mode Select. PCM determines the format of the LRCLK_D and LRCLK_A signal:</p> <p>0—The LRCLK_D and LRCLK_A signals have a 50% duty cycle. Left-channel audio is transmitted during one state of and right-channel audio during the other state.</p> <p>1—LRCLK_D and LRCLK_A are pulses that indicate the start of a frame of audio data consisting of two channels. Following the frame sync pulse, 16 bits of left-channel data is immediately followed by 16 bits of right-channel data. The DDLY and WS bits are ignored when PCM = 1.</p>
DHF	<p>DAC High-Sample Rate Mode:</p> <p>0—LRCLK_D is less than 50kHz. 8x FIR interpolation filter used.</p> <p>1—LRCLK_D is greater than 50kHz. 4x FIR interpolation filter used.</p>
WS	<p>Word Size. This bit controls both the DAC and ADC:</p> <p>0—16 bits.</p> <p>1—18 bits.</p> <p>The DAC interface can accept higher than 18-bit words but the additional least significant bits are ignored.</p>
DPLEN	<p>DAC PLL Enable:</p> <p>0 (valid for slave and master mode)—The frequency of LRCLK_D is set by the DACNI divider bits. In master mode, the MAX9856 generates LRCLK_D using the specified divide ratio. In slave mode, the MAX9856 expects an LRCLK_D as specified by the divide ratio.</p> <p>1 (valid for slave mode only)—A digital PLL locks on to any externally supplied LRCLK_D signal regardless of the MCLK frequency. DHF must set high for sample rates above 50kHz.</p>
DACNI	<p>DAC LRCLK Divider. When DPLEN is set low, the frequency of LRCLK_D is determined by DACNI. See Table 6 for common DACNI values:</p> <p>$DACNI = (65536 \times 96 \times f_{LRCLK_D}) / f_{PCLK}$ for (DHF = 0).</p> <p>$DACNI = (65536 \times 48 \times f_{LRCLK_D}) / f_{PCLK}$ for (DHF = 1).</p> <p>f_{LRCLK_D} = LRCLK_D frequency.</p> <p>f_{PCLK} = Prescaled MCLK internal clock frequency (PCLK).</p>

Table 6. Common DACNI and ADCNI Values

MCLK (MHz)	PSCLK	LRCLK						
		8kHz	16kHz	32kHz	44.1kHz	48kHz	88.2kHz (DAC ONLY)	96kHz (DAC ONLY)
11.2896	001	116A	22D4	45A9	6000	687D	6000	687D
12	001	1062	20C5	4189	5A51	624E	5A51	624E
12.288	001	1000	2000	4000	5833	6000	5833	6000
13	001	F20	1E3F	3C7F	535F	5ABE	535F	5ABE
16.9344	010	B9C	1738	2E71	4000	45A9	4000	45A9
18.432	010	AAB	1555	2AAB	3ACD	4000	3ACD	4000
19.2	010	960	4B0	258	1B3	190	1B3	190
24	011	1062	20C5	4189	5A51	624E	5A51	624E
26	011	F20	1E3F	3C7F	535F	5ABE	535F	5ABE
27	011	E90	1D21	3A41	5048	5762	5048	5762

Note: Values in bold are exact integers that provide maximum full-scale performance.

Low-Power Audio CODEC with DirectDrive Headphone Amplifiers

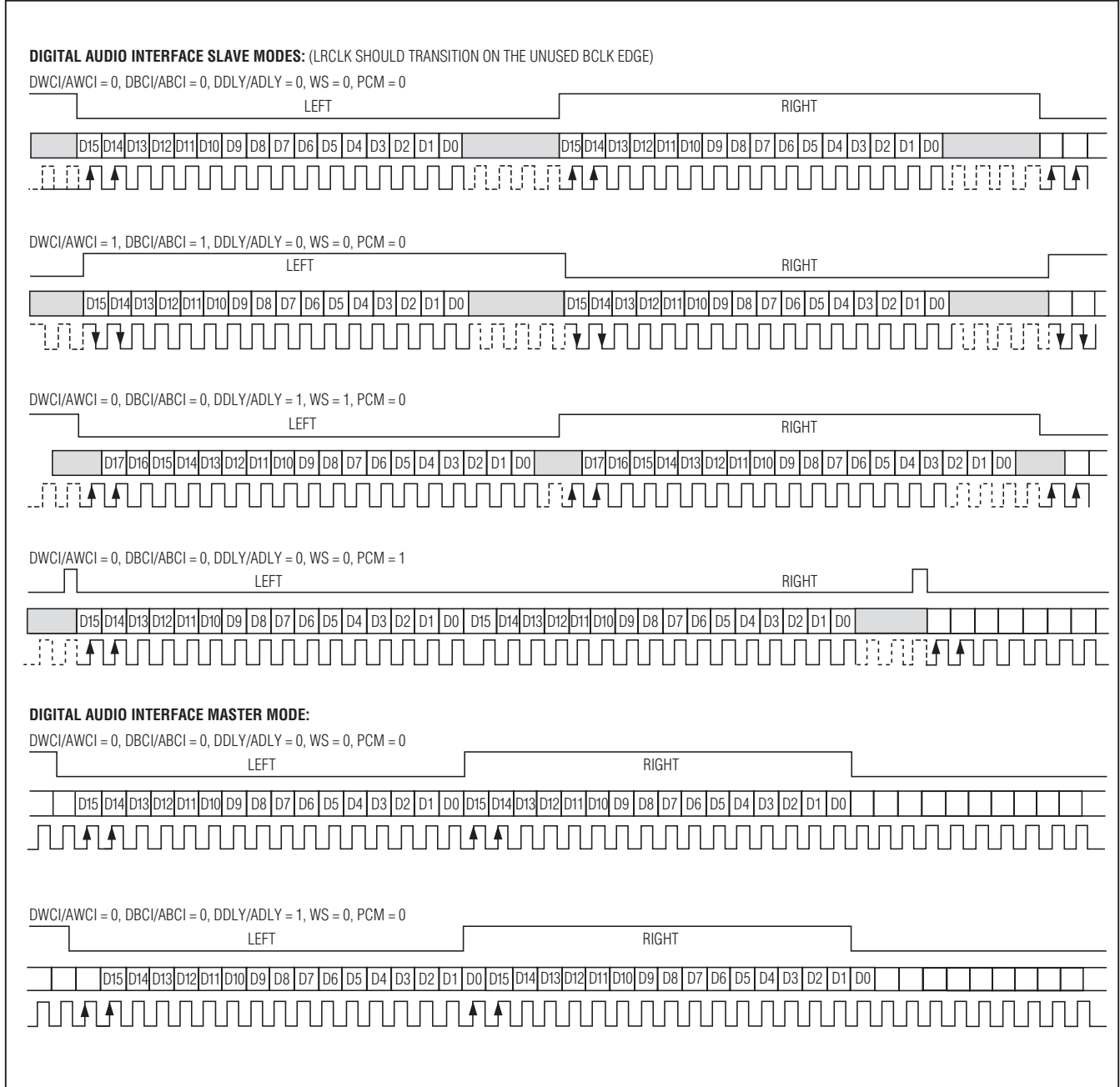

Figure 1. Digital Audio Interface Data Format Examples

Low-Power Audio CODEC with DirectDrive Headphone Amplifiers

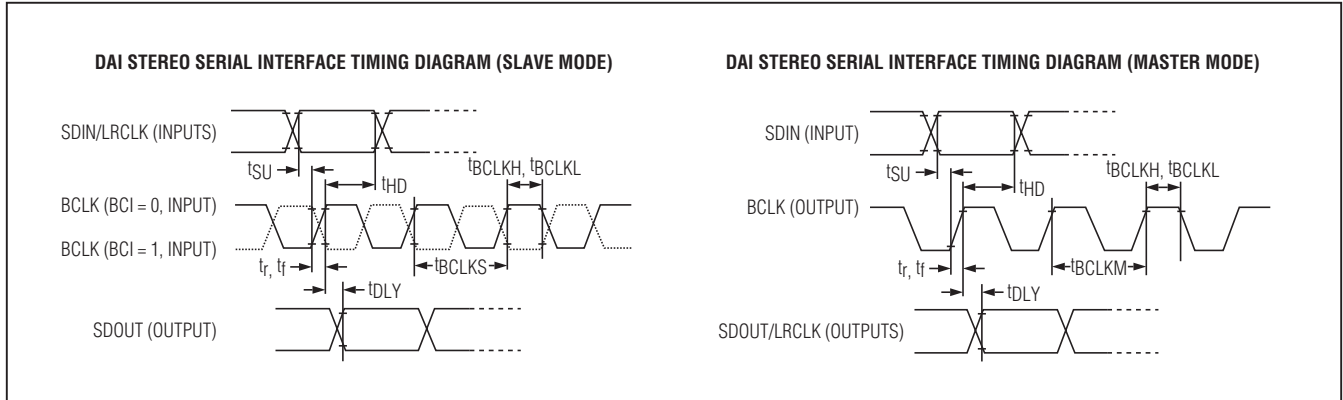

Figure 2. Digital Audio Interface Timing Diagrams

ADC Interface

The stereo ADC is capable of outputting data at any sample rate from 8kHz to 48kHz. Data can be output in common formats including left justified, I²S, and PCM (Figure 1). Figure 2 shows the digital timing in both slave and master modes.

If the DAC and ADC operate at the same sample rate only the LRCLK_D is needed, allowing the LRCLK_A pin to be reassigned as a GPIO. When configured as a general-purpose output, LRCLK_A can be set high or low by the APIN bits. When configured as a general-purpose input, the status is reported in register 0x00. Table 7 lists and describes the ADC interface registers.

Table 7. ADC Interface Registers

REG	B7	B6	B5	B4	B3	B2	B1	B0
0x07	AWCI	ABCI	APIN		ADLY	0	0	0
0x08	APLEN	ADCNI[14:8]						
0x09	ADCNI[7:0]							
0x0A	AGAIN				ANTH			

ADC Interface Register Bit Description

REGISTER	FUNCTION
AWCI	ADC Word Clock (LRCLK_A) Invert When PCM = 0: 0—Left-channel data is transmitted while LRCLK_A is low. 1—Right-channel data is transmitted while LRCLK_A is low. When PCM = 1: 0—Start of a new frame is signified by the falling edge of the LRCLK_A pulse. 1—Start of a new frame is signified by the rising edge of the LRCLK_A pulse.
ABCI	ADC BCLK Invert: 0—SDOUT is valid on the rising edge of BCLK. 1—SDOUT is valid on the falling edge of BCLK. If operating in master mode, the ABCI bit has no effect. The DBCI bit controls BCLK to LRCLK_A timing.

Low-Power Audio CODEC with DirectDrive Headphone Amplifiers

ADC Interface Register Bit Description (continued)

REGISTER	FUNCTION	
APIN	LRCLK_A/GPIO Configuration: 00 = General-purpose input 01 = Word clock for the ADC 10 = General-purpose output—low 11 = General-purpose output—high When APIN ≠ 01, LRCLK_D is used as the word clock for both the DAC and ADC. AWCI, ABCI, and ADLY are still active and independent from the DAC mode bit settings when operating with a shared LRCLK_D.	
ADLY	ADC Data Delay 0—The most significant bit of an audio word is valid at the first BCLK edge after the LRCLK_A transition. 1—The most significant bit of an audio word is valid at the second BCLK edge after the LRCLK_A transition. (ADLY = 1 for I ² S-compatible mode)	
APLLEN	ADC PLL Enable. This bit only applies when APIN = 01. When APIN ≠ 01 use DPllen for both the DAC and ADC: 0 (Valid for slave and master mode)—The frequency of LRCLK_A is set by the ADCNI divider bits. In master mode, the MAX9856 generates LRCLK_A using the specified divide ratio. In slave mode, the MAX9856 expects an LRCLK_A using specified divide ratio. 1 (Valid for slave mode only)—A digital PLL locks on to any externally supplied LRCLK_A signal regardless of the MCLK frequency.	
ADCNI	ADC LRCLK Divider. If APIN ≠ 01, use DACNI for both the DAC and ADC. When APLLEN is set low, the frequency of LRCLK_A is determined by ADCNI. See Table 6 for common ADCNI values: $ADCNI = (65536 \times 96 \times f_{LRCLK_A}) / f_{PCLK}$ f_{LRCLK_A} = LRCLK_A frequency. f_{PCLK} = Prescaled MCLK internal clock frequency (PCLK).	
AGAIN	ADC Output Gain. Specifies the gain applied to the digital output of the ADC prior to being output from the device.	
	VALUE	GAIN (dB)
	0x0	+3
	0x1	+2
	0x2	+1
	0x3	0
	0x4	-1
	0x5	-2
	0x6	-3
	0x7	-4
	0x8	-5
	0x9	-6
	0xA	-7
	0xB	-8
	0xC	-9
	0xD	-10
0xE	-11	
0xF	-12	

Low-Power Audio CODEC with DirectDrive Headphone Amplifiers

ADC Interface Register Bit Description (continued)

REGISTER	FUNCTION	
ANTH	ADC Noise Gate Threshold. The MAX9856 features a noise gate that reduces the audible noise at low signal levels. The noise gate attenuates the output at a rate of 1dB for each 2dB the signal is below the threshold. ANTH specifies the noise gate threshold level relative to the final ADC output signal level.	
	The noise gate can be used in conjunction with AGC or on its own. When AGC is enabled, the noise gate reduces the output level only when the AGC has set the gain to the maximum setting. Choose a threshold between -28dB and -48dB when used in conjunction with the AGC. When the AGC is enabled, the effective noise gate thresholds are increased by 20dB due to the microphone PGA being set to maximum gain by the AGC.	
	ADC NOISE GATE THRESHOLD LEVELS	
	VALUE	THRESHOLD (dB)
	0x0 to 0x5	Disabled
	0x6	-64
	0x7	-60
	0x8	-56
	0x9	-52
	0xA	-48
	0xB	-44
	0xC	-40
	0xD	-36
	0xE	-32
0xF	-28	

Digital Filters

The MAX9856 digital audio interface includes digital first-order highpass filters (Table 8) for both the DAC input and the ADC output. The corner frequency for each filter is selectable from 5Hz to 4kHz. The DAC filter (DACHP) can be used to reduce the low-frequency

energy sent to speakers incapable of reproducing low frequencies. The ADC filter (ADCHP) can reduce low-frequency noise such as wind noise from being converted. The cutoff frequency depends on sample rate and is shown in Table 9.

Table 8. Digital Highpass Filters

REG	B7	B6	B5	B4	B3	B2	B1	B0
0x0B	0	ADCHP			0	DACHP		

Low-Power Audio CODEC with DirectDrive Headphone Amplifiers

Table 9. Digital Highpass Filter Cutoff Frequencies

LRCLK (kHz)	ADCHP/DACHP							
	000	001 (Hz)	010 (Hz)	011 (Hz)	100 (Hz)	101 (Hz)	110 (Hz)	111 (Hz)
8	Off	5	10	20	41	82	170	364
11.025	Off	7	14	28	56	114	235	501
12	Off	8	15	30	61	124	255	545
16	Off	10	20	40	81	165	340	727
22.05	Off	14	28	55	112	227	469	1002
24	Off	15	30	60	122	247	511	1091
32	Off	20	40	80	162	330	681	1455
44.1	Off	28	55	111	224	455	938	2005
48	Off	30	60	121	244	495	1021	2182
64	Off	40	80	161	325	660	1362	2909
88	Off	55	111	222	448	909	1877	4009
96	Off	60	120	241	487	990	2043	4364

Automatic Gain Control

The MAX9856 AGC continuously adjusts the analog microphone PGAs to maintain constant signal level. When the AGC is enabled, manual control of the input PGA is not possible. The PGA includes zero-cross detection, which prevents gain changes, from being audible.

The AGC process consists of three main sections. When the AGC threshold is exceeded, the gain is reduced exponentially with a time constant referred to as the attack time. Once the large signal has passed,

the AGC waits the specified hold time before reducing the gain. The time required to reduce the gain from maximum attenuation to minimum attenuation is known as the release time.

The AGC circuitry only operates on the PGA in the microphone path, but the digital level detector is based on the mixed signal. Only use the AGC when input signals from the LINEIN and AUXIN are excluded or attenuated.

Table 10 lists the AGC registers and shows the AGC register bit description.

Table 10. Automatic Gain Control Registers

REG	B7	B6	B5	B4	B3	B2	B1	B0
0x0C	0	AGCRLS			AGCATK		AGCHLD	
0x0D	0	0	0	AGCSRC	AGCSTH			

AGC Register Bit Description

BITS	FUNCTION
AGCRLS	<p>AGC Release Time. The release time is the time it takes for the gain to return to its normal level after the input signal has fallen below the threshold and the hold time has passed:</p> <p>000—78ms 001—156ms 010—312ms (recommended) 011—625ms 100—1.25s 101—2.5s 110—5s 111—10s</p>

Low-Power Audio CODEC with DirectDrive Headphone Amplifiers

MAX9856

AGC Register Bit Description (continued)

BITS	FUNCTION	
AGCATK	<p>AGC Attack Time. The attack time is the time it takes to reduce the gain after the input signal has exceeded the threshold level. The gain attenuation during attack is exponential and the attack time is defined as one-time constant rather than the time it takes to reach the final gain:</p> <p>00—3ms 01—12ms 10—50ms (recommended) 11—200ms</p>	
AGCHLD	<p>AGC Hold Time. Hold time is the delay before the AGC release begins. The hold time counter starts whenever the signal drops below the AGC threshold and is reset by any signal that exceeds the threshold:</p> <p>00—AGC disabled 01—50ms 10—100ms (recommended) 11—400ms</p>	
AGCSRC	<p>AGC and Noise Gate Signal Source. Selects the audio signal that the AGC and noise gate circuitry monitors:</p> <p>0—Left-channel ADC output 1—Left-channel + right channel ADC output (results in 3dB lower threshold for coherent signals)</p>	
AGCSTH	<p>AGC Threshold. Sets the signal level at which the AGC begins gain reduction. The signal is monitored after the ADC output gain has been applied.</p>	
	AGC THRESHOLD LEVELS	
	AGCSTH	LEVEL (dB)
	0000	-3
	0001	-4
	0010	-5
	0011	-6
	0100	-7
	0101	-8
	0110	-9
	0111	-10
	1000	-11
	1001	-12
	1010	-13
	1011	-14
	1100	-15
	1101	-16
1110	-17	
1111	-18	

Low-Power Audio CODEC with DirectDrive Headphone Amplifiers

Analog Mixers

The MAX9856 has two main analog mixers. The first feeds signals into the headphone and line output amplifiers while the second supplies the ADC input.

Each mixer is configurable independently for left and right channels. See Table 11 for audio mixer control registers and register bit description.

Table 11. Audio Mixer Control Registers

REG	B7	B6	B5	B4	B3	B2	B1	B0
0x0E	0	0	0	MXINL				
0x0F	0	0	0	MXINR				
0x10	MXOUTL				MXOUTR			

Audio Mixer Register Bit Description

BITS	FUNCTION	
MXINL/MXINR	ADC INPUT MIXER DESCRIPTION	
	MXINL OR MXINR	SELECTED INPUT SOURCE
	00000	No input source selected
	1XXXX	AUXOUT selected
	X1XXX	LINEIN1 selected
	XX1XX	LINEIN2 selected
	XXX1X	MICL selected
	XXXX1	MICR selected
MXOUTL/MXOUTR	AUDIO OUTPUT MIXER DESCRIPTION	
	MXOUTL OR MXOUTR	SELECTED INPUT SOURCE
	0000	No input source selected
	1XXX	MIC L/R PGA output selected
	X1XX	LINEIN1 selected
	XX1X	LINEIN2 selected
	XXX1	DAC output selected

Low-Power Audio CODEC with DirectDrive Headphone Amplifiers

Analog Inputs

The MAX9856 features various analog inputs. All inputs have independent gain control for maximum flexibility.

AUXIN is a mono auxiliary input that can be used for mixing alarms, beeps, and sound effects into the headphone outputs or ADC input. The AUXIN signal has a dedicated PGA for gain adjustment and can be mixed into the headphone output signal directly, bypassing the output mixer and volume control. AUXIN can also serve as an input for making precise measurements in the system. In this mode, the PGA is bypassed, increasing the impedance of the input, and is directly connected to the ADC.

Three microphone inputs are available. Two are pseudo-differential inputs with a shared ground connected to the

inverting input of the microphone preamplifier. The third is a fully differential input. Stereo microphones that share a common return path can take advantage of the pseudo-differential configuration by connecting the common return to the MICGND, canceling common-mode noise. Figure 3 shows the typical application circuit for both single-ended and differential microphones. The microphone preamplifier and PGA provide a wide range of gain options. The microphone inputs can also be used as additional line inputs when the gain is set to 0dB.

A single low-noise bias voltage output is available (MICBIAS) to bias microphones from a clean supply with an external bias resistor. There are two selectable microphone bias voltages that can be selected depending on the power-supply voltage. Table 12 lists the audio input control registers and bit description.

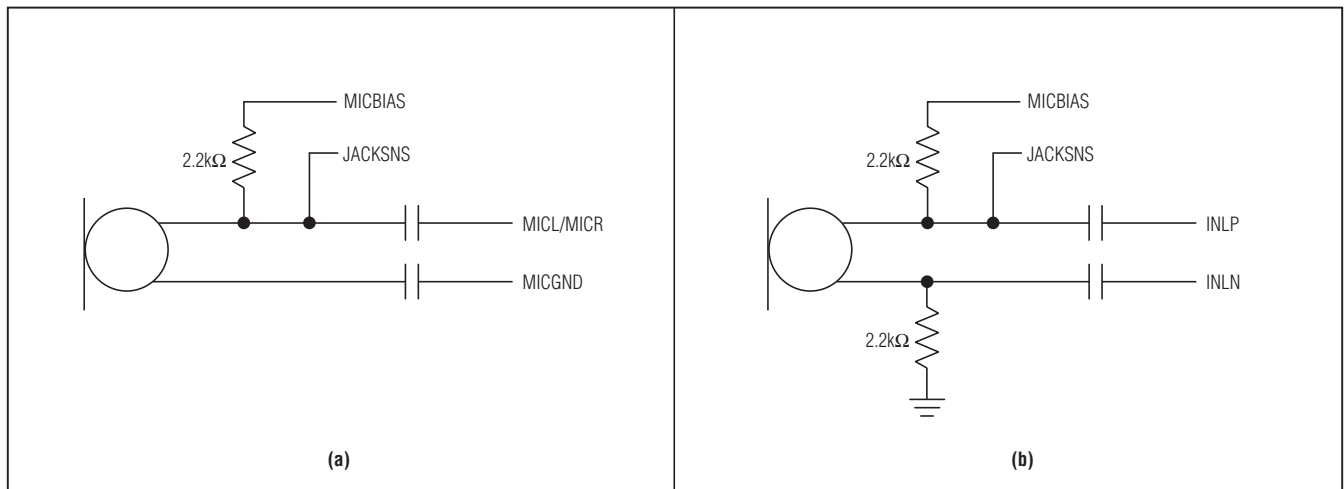

Figure 3. Typical Microphone Connections: (a) Pseudo-Differential, (b) Differential

Table 12. Audio Input Control Registers

REG	B7	B6	B5	B4	B3	B2	B1	B0
0x11	PGADS							
0x12	0	0	0	PGAAUX				
0x13	0	0	0	PGAL1				
0x14	0	0	0	PGAL2				
0x15	0	PAENL		PGAML				
0x16	0	PAENR		PGAMR				
0x17	0	0	0	0	MMIC	MBSEL	0	LMICDIF

Low-Power Audio CODEC with DirectDrive Headphone Amplifiers

Audio Input Register Bit Description

BITS	FUNCTION			
	PGADS	Programmable Gain Adjust for Digital Audio Input		
DIGITAL AUDIO INPUT PGA SETTINGS				
SETTING		GAIN (dB)	SETTING	GAIN (dB)
0x00		0	0x93	-15
0x07		-0.5	0x96	-15.5
0x0E		-1	0x99	-16
0x15		-1.5	0x9C	-16.5
0x1C		-2	0x9F	-17
0x22		-2.5	0xA2	-17.5
0x29		-3	0xA5	-18
0x2F		-3.5	0xA7	-18.5
0x35		-4	0xAA	-19
0x3A		-4.5	0xAC	-19.5
0x40		-5	0xAE	-20
0x45		-5.5	0xB3	-21
0x4A		-6	0xB7	-22
0x50		-6.5	0xBB	-23
0x55		-7	0xBF	-24
0x59		-7.5	0xC2	-25
0x5E		-8	0xC6	-26
0x63		-8.5	0xC9	-27
0x67		-9	0xCC	-28
0x6B		-9.5	0xCF	-29
0x70		-10	0xD2	-30
0x74		-10.5	0xD4	-31
0x78		-11	0xD6	-32
0x7C		-11.5	0xD9	-33
0x7F		-12	0xDB	-34
0x83		-12.5	0xDD	-35
0x86		-13	0xDF	-36
0x8A	-13.5	0xE1	-37	
0x8D	-14	0xE2	-38	
0x90	-14.5	0xE4	-39	
—	—	0xE5	-40	

Low-Power Audio CODEC with DirectDrive Headphone Amplifiers

MAX9856

Audio Input Register Bit Description (continued)

BITS	FUNCTION			
PGAAUX/ PGAL1/ PGAL2	Programmable Gain Adjust for Line Inputs			
	LINE INPUT PGA SETTINGS			
	SETTING	GAIN (dB)	SETTING	GAIN (dB)
	0x00	+30	0x10	-2
	0x01	+28	0x11	-4
	0x02	+26	0x12	-6
	0x03	+24	0x13	-8
	0x04	+22	0x14	-10
	0x05	+20	0x15	-12
	0x06	+18	0x16	-14
	0x07	+16	0x17	-16
	0x08	+14	0x18	-18
	0x09	+12	0x19	-20
	0x0A	+10	0x1A	-22
	0x0B	+8	0x1B	-24
	0x0C	+6	0x1C	-26
	0x0D	+4	0x1D	-28
	0x0E	+2	0x1E	-30
	0x0F	+0	0x1F	-32

Low-Power Audio CODEC with DirectDrive Headphone Amplifiers

Audio Input Register Bit Description (continued)

BITS	FUNCTION	
PGAML/ PGAMR	Left/Right Programmable Gain Adjustment for Microphone Inputs. When AGC is enabled, the PGAML and PGAMR bits cannot be manually programmed. The PGAML register can be monitored to determine the gain set by the AGC.	
	MICROPHONE PGA SETTINGS	
	SETTING	GAIN (dB)
	SETTING	GAIN (dB)
	0x00	+20
	0x0B	+9
	0x01	+19
	0x0C	+8
	0x02	+18
	0x0D	+7
	0x03	+17
	0x0E	+6
	0x04	+16
0x0F	+5	
0x05	+15	
0x10	+4	
0x06	+14	
0x11	+3	
0x07	+13	
0x12	+2	
0x08	+12	
0x13	+1	
0x09	+11	
0x14 to 0x1F	0	
0x0A	+10	
—	—	
PAENL/PAENR	Left/Right Microphone Preamp Enable. Enables the microphone circuitry and sets the preamplifier gain: 00—Microphones disabled 01—0dB 10—20dB 11—30dB	
MMIC	Microphone Mute Enable	
MBSEL	MICBIAS Voltage Select: 0—MICBIAS = 1.5V 1—MICBIAS = 2.4V (use only when AVDD ≥ 2.7V)	
LMICDIF	Left Microphone Input Select: 0—MICL/MICGND (pseudo-differential input) 1—INLP/INLN (differential input)	

Low-Power Audio CODEC with DirectDrive Headphone Amplifiers

Audio Outputs

The MAX9856 features stereo headphone amplifiers and line output amplifiers with DirectDrive technology. DirectDrive eliminates the need for bulky and expensive DC-blocking capacitors on the outputs. The DirectDrive biasing scheme is illustrated in Figure 4. The headphone outputs have separate left/right volume controls while the line outputs produce a fixed level signal.

The audio outputs feature ground sensing, which is intended to reduce the effect of ground noise. In many systems, the ground return for line outputs and headphone jacks is used by other functions such as video

signals and microphone signals. The sharing of ground can result in interference that is audible. The MAX9856's ground sense provides a path for the interfering signal to be input and combined with the output audio signal to reduce the audibility of the interference. Connect HGND-SNS directly to the ground terminal of the headphone jack to enable ground sense on the headphones (Figure 5). Similarly connect LGNDSNS directly to the ground terminal of a line output jack to enable ground sense on the line outputs. If ground sense is not required, connect HGNDSNS and LGNDSNS to AGND. Table 13 lists the audio output control registers and bit description.

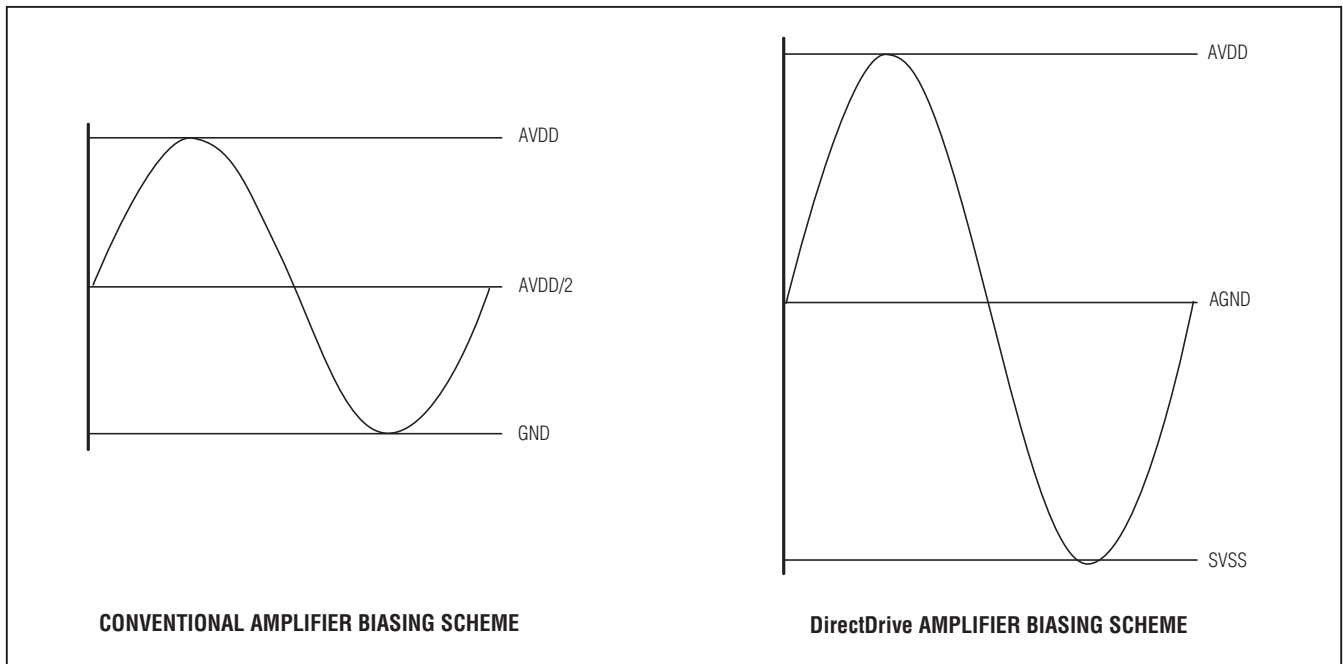

Figure 4. Traditional Amplifier Output vs. MAX9856 DirectDrive Output

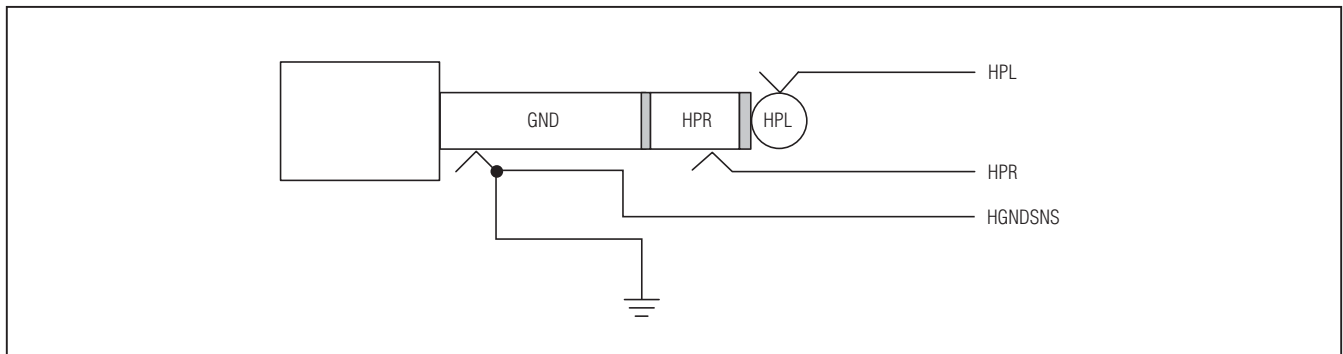

Figure 5. Ground Sense Connection

Low-Power Audio CODEC with DirectDrive Headphone Amplifiers

Table 13. Audio Output Control Registers

REGISTER	B7	B6	B5	B4	B3	B2	B1	B0
0x18	0	HPMUTE	HPVOLL					
0x19	0	0	HPVOLR					
0x1A	0	VSEN	AUXDC	AUXMIX	0	0	HPMODE	

Audio Output Register Bit Description

BITS	FUNCTION					
HPMUTE	Headphone Mute Enable					
HPVOLL/HPVOLR	Headphone Volume Control					
	HEADPHONE VOLUME-CONTROL SETTINGS					
	SETTING	GAIN (dB)	SETTING	GAIN (dB)	SETTING	GAIN (dB)
	0x00	+5.5	0x0E	-8	0x1C	-36
	0x01	+5	0x0F	-10	0x1D	-38
	0x02	+4.5	0x10	-12	0x1E	-40
	0x03	+4	0x11	-14	0x1F	-42
	0x04	+3.5	0x12	-16	0x20	-46
	0x05	+3	0x13	-18	0x21	-50
	0x06	+2.5	0x14	-20	0x22	-54
	0x07	+2	0x15	-22	0x23	-58
	0x08	+1	0x16	-24	0x24	-62
	0x09	0	0x17	-26	0x25	-66
	0x0A	-1	0x18	-28	0x26	-70
	0x0B	-2	0x19	-30	0x27	-74
	0x0C	-4	0x1A	-32	0x28 to 0x3F	Mute
0x0D	-6	0x1B	-34	—	—	
VSEN	Volume Slewing Enable. Enables volume slewing so that when a volume change is made, the actual volume control steps through all intermediate settings to give a smooth sounding change.					
AUXDC	Auxiliary Input DC Measurement Mode: 0—AUXIN connected to the input PGA for audio signals. 1—AUXIN directly connected to the ADC input for DC measurements. Set MXINL to 10000 for proper operation.					
AUXMIX	Auxiliary Input Connected to Headphone Amplifiers: 0—AUXIN not connected to the headphone amplifiers. 1—AUXIN mixed directly into the headphone amplifiers bypassing the output mixer.					
HPMODE	Headphone Output Mode: 00—Shutdown 01—Standard mono mode (HPL = mono, HPR = shutdown) 10—Dual mono mode (HPL = HPR = mono) 11—Stereo mode					

Low-Power Audio CODEC with DirectDrive Headphone Amplifiers

Headset Detection

The MAX9856 features headset detection that can detect the insertion and removal of a jack as well as the load type. When a jack is detected, an interrupt on \overline{IRQ} can be triggered to alert the microcontroller of the event. Figure 6 shows the typical configuration for jack detection and Table 14 shows the headset detect control register and bit description.

Sleep-Mode Jack Detection

When the MAX9856 is in shutdown and the power supply is available, sleep mode jack detection can be enabled to detect jack insertion. Sleep mode applies a $2\mu\text{A}$ pullup current to JACKSNS and HPL, which forces the voltage on JACKSNS and HPL to AVDD when no load is applied. When a jack is inserted, either JACKSNS, HPL, or both are loaded sufficiently to reduce the output voltage to nearly 0V and clear the JKSNS or LSNS bits, respectively. The change in the LSNS and JKSNS bits sets JDET and triggers an interrupt on \overline{IRQ} if IJDET is set. The interrupt signals the microcontroller that a jack has been inserted, allowing the microcontroller to respond as desired.

Powered-On Jack Detection

When the MAX9856 is in normal operation and the microphone interface is enabled, jack insertion and

removal can be detected through the JACKSNS pin. As shown in Figure 6, V_{MIC} is pulled up by MICBIAS. When a microphone is connected, V_{MIC} is assumed to be between 0V and 95% of $V_{MICBIAS}$. If the jack is removed, V_{MIC} increases to $V_{MICBIAS}$. This event causes JKMIC to be set, alerting the system that the headset has been removed. Alternatively, if the jack is inserted, V_{MIC} decreases to below 95% of $V_{MICBIAS}$ and JKMIC is cleared, alerting that a jack has been inserted. The JKMIC bit can be configured to create a hardware interrupt that alerts the microcontroller of jack removal and insertion events.

Impedance Detection

The MAX9856 is able to detect the type of load connected by applying a 2mA pullup current to HPL, HPR, and JACKSNS. To minimize click-and-pop the current is ramped up and down over a 24ms period. The 2mA current can be individually applied to HPL, HPR, and JACKSNS by appropriately configuring the EN bits. When the 2mA current has finished ramping, HSDETL, HSDETR, and JSDET are updated to reflect the measured impedance. EN must be cleared and reset to re-measure the impedance. Figure 7 and Table 15 illustrate the impedance detection process.

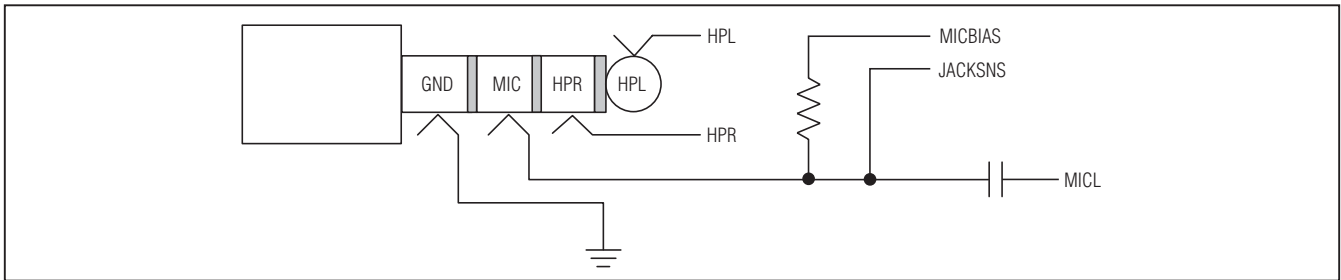

Figure 6. Example Jack Configuration for Jack Detection

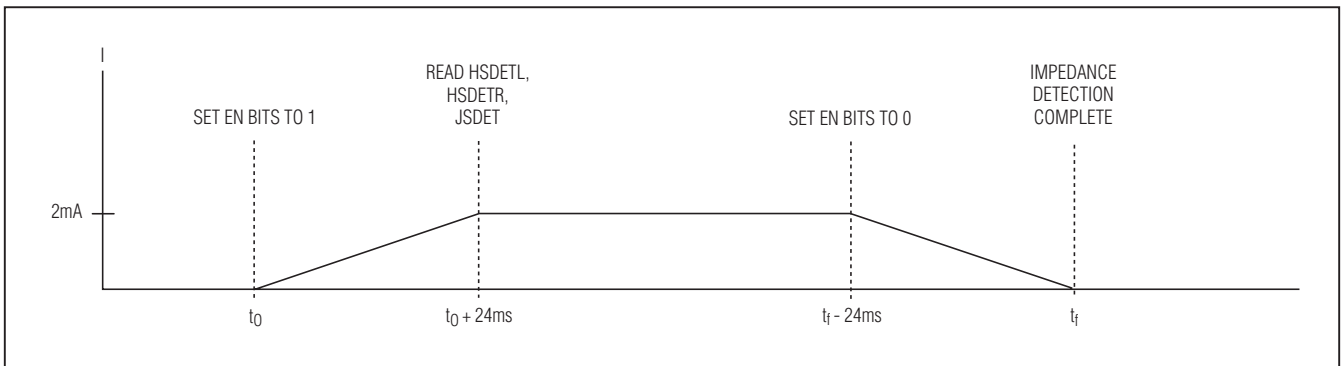

Figure 7. Current on HPL, HPR, or JACKSNS During Impedance Detection

Low-Power Audio CODEC with DirectDrive Headphone Amplifiers

Table 14. Headset Detect Control Register

REG	B7	B6	B5	B4	B3	B2	B1	B0
0x1B	0	0	0	0	JDETEN		EN	

Table 15. Impedance Detection Routine

TIME	EVENT
t_0	Disable the headphone amplifiers. Set EN = 111 to enable the detection circuitry.
$t_0 + 24\text{ms}$	$\overline{\text{IRQ}}$ set high. Indicates that the detection current has reached its final value and the impedance has been stored in HSDETL, HSDETR, and JSDET.
$t_f - 24\text{ms}$	Once the impedance of HPL, HPR, and JACKSNS has been read, set EN = 000 to shut down the detection circuitry.
t_f	$\overline{\text{IRQ}}$ set high. Indicates that the detection circuitry is completely shut down and the headphone amplifiers can be reenabled.

Headset Detection Register Bit Description

BIT	FUNCTION	
JDETEN	Jack Detection Enable Sleep Mode—Enables pullups on HPL and JACKSNS to detect jack insertion. LSNS and JKSNS are not valid unless JDETEN = 1 and $\overline{\text{SHDN}} = 0$. Normal Mode—Enables the comparator circuitry on JACKSNS to detect voltage changes. JKMIC is not valid unless JDETEN = 1 and the microphone circuitry is enabled.	
EN	Impedance Detection Enable. Enables the impedance detection circuitry for HPL, HPR, and JACKSNS. When EN = 000 HSDETL, HSDETR, and JSDET are set to 11. See Table 2, Status Register Bit Description for details on reading the load impedance.	
	IMPEDANCE DETECTION ENABLE DESCRIPTION	
	EN	DESCRIPTION
	000	Disabled
	1xx	JACKSNS pin impedance sense enabled
x1x	HPR pin impedance sense enabled	
xx1	HPL pin impedance sense enabled	

Low-Power Audio CODEC with DirectDrive Headphone Amplifiers

Power Management and Control

The MAX9856 has comprehensive power management that allows unused features to be disabled, thereby

saving power. Table 16 shows the power/management register and a register bit description.

Table 16. Power-Management Register

REGISTER	B7	B6	B5	B4	B3	B2	B1	B0
0x1C	$\overline{\text{SHDN}}$	0	DIGEN	LOUTEN	DALEN	DAREN	ADLEN	ADREN

Power-Management Register Bit Description

BITS	FUNCTION
$\overline{\text{SHDN}}$	Shutdown. Overrides all settings and forces the entire device into a shutdown state.
DIGEN	Digital Core Enable. Set high to use either the DAC or ADC.
LOUTEN	Line Output Enable.
DALEN	Left DAC Enable.
DAREN	Right DAC Enable.
ADLEN	Left ADC Enable.
ADREN	Right ADC Enable.

I²C Serial Interface

The MAX9856 features an I²C/SMBus™-compatible, 2-wire serial interface consisting of a serial-data line (SDA) and a serial-clock line (SCL). SDA and SCL facilitate communication between the MAX9856 and the master at clock rates up to 400kHz. Figure 8 shows the 2-wire interface timing diagram. The master generates SCL and initiates data transfer on the bus. The master device writes data to the MAX9856 by transmitting the proper slave address followed by the register address and then the data word. Each transmit sequence is framed by a START (S) or REPEATED START (Sr) condition and a STOP (P) condition. Each word transmitted to the MAX9856 is 8 bits long and is followed by an acknowledge clock pulse. A master reading data from the MAX9856 transmits the proper slave address

followed by a series of nine SCL pulses. The MAX9856 transmits data on SDA in sync with the master-generated SCL pulses. The master acknowledges receipt of each byte of data. Each read sequence is framed by a START or REPEATED START condition, a not acknowledge, and a STOP condition. SDA operates as both an input and an open-drain output. A pullup resistor, typically greater than 500Ω, is required on SDA. SCL operates only as an input. A pullup resistor, typically greater than 500Ω, is required on SCL if there are multiple masters on the bus, or if the single master has an open-drain SCL output. Series resistors in line with SDA and SCL are optional. Series resistors protect the digital inputs of the MAX9856 from high voltage spikes on the bus lines, and minimize crosstalk and undershoot of the bus signals.

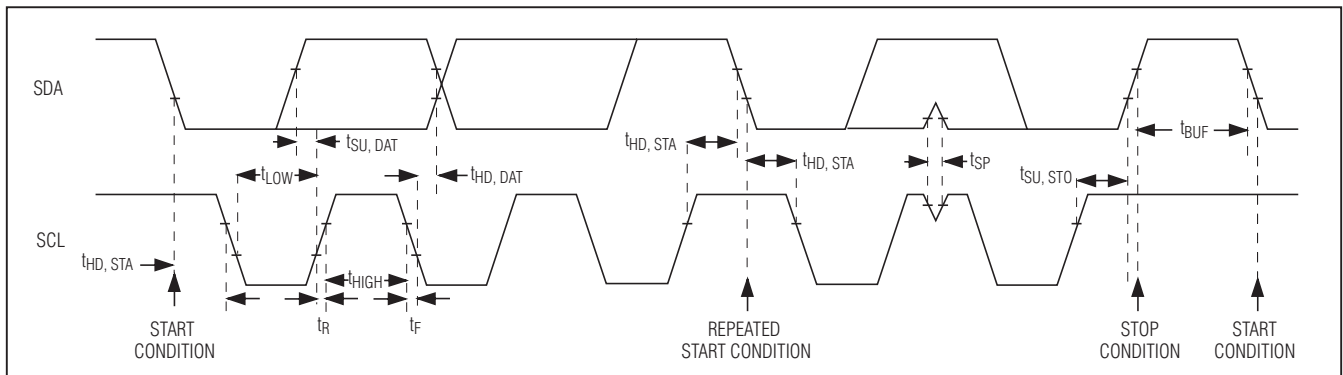

Figure 8. 2-Wire Interface Timing Diagram

SMBus is a trademark of Intel Corp.

Low-Power Audio CODEC with DirectDrive Headphone Amplifiers

Bit Transfer

One data bit is transferred during each SCL cycle. The data on SDA must remain stable during the high period of the SCL pulse. Changes in SDA while SCL is high are control signals (see the *START and STOP Conditions* section).

START and STOP Conditions

SDA and SCL idle high when the bus is not in use. A master initiates communication by issuing a START condition. A START condition is a high-to-low transition on SDA with SCL high. A STOP condition is a low-to-high transition on SDA while SCL is high (Figure 9). A START condition from the master signals the beginning of a transmission to the MAX9856. The master terminates transmission, and frees the bus, by issuing a STOP condition. The bus remains active if a REPEATED START condition is generated instead of a STOP condition.

Early STOP Conditions

The MAX9856 recognizes a STOP condition at any point during data transmission except if the STOP condition occurs in the same high pulse as a START condition. For proper operation, do not send a STOP condition during the same SCL high pulse as the START condition.

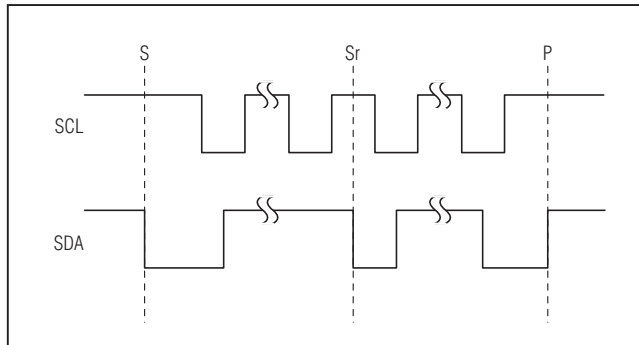

Figure 9. START, STOP, and REPEATED START Conditions

Slave Address

The MAX9856 is preprogrammed with a slave address of 0x20 or 0010000. The address is defined as the 7 most significant bits (MSBs) followed by the read/write bit. Setting the read/write bit to 1 configures the MAX9856 for read mode. Setting the read/write bit to 0 configures the MAX9856 for write mode. The address is the first byte of information sent to the MAX9856 after the START condition.

Acknowledge

The acknowledge bit (ACK) is a clocked 9th bit that the MAX9856 uses to handshake receipt of each byte of data when in write mode (see Figure 10). The MAX9856 pulls down SDA during the entire master-generated 9th clock pulse if the previous byte is successfully received. Monitoring ACK allows for detection of unsuccessful data transfers. An unsuccessful data transfer occurs if a receiving device is busy or if a system fault has occurred. In the event of an unsuccessful data transfer, the bus master retries communication.

The master pulls down SDA during the 9th clock cycle to acknowledge receipt of data when in read mode. An acknowledge is sent by the master after each read byte to allow data transfer to continue. A not acknowledge is sent when the master reads the final byte of data from the MAX9856, followed by a STOP condition.

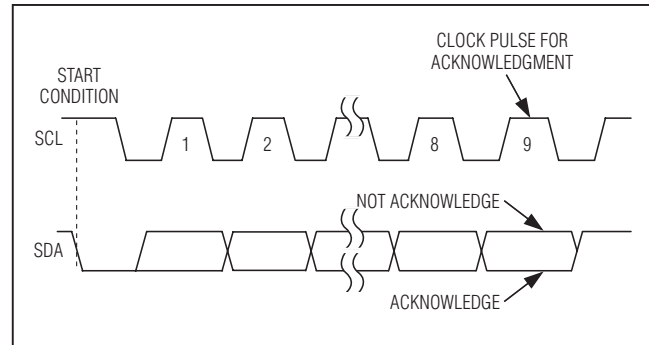

Figure 10. Acknowledge

Low-Power Audio CODEC with DirectDrive Headphone Amplifiers

Write Data Format

A write to the MAX9856 includes transmission of a START condition, the slave address with the R/W bit set to 0, 1 byte of data to configure the internal register address pointer, 1 or more bytes of data, and a STOP condition. Figure 11 illustrates the proper frame format for writing 1 byte of data to the MAX9856. Figure 12 illustrates the frame format for writing n-bytes of data to the MAX9856.

The slave address with the R/W bit set to 0 indicates that the master intends to write data to the MAX9856. The MAX9856 acknowledges receipt of the address byte during the master-generated 9th SCL pulse.

The second byte transmitted from the master configures the MAX9856's internal register address pointer.

The pointer tells the MAX9856 where to write the next byte of data. An acknowledge pulse is sent by the MAX9856 upon receipt of the address pointer data.

The third byte sent to the MAX9856 contains the data that is written to the chosen register. An acknowledge pulse from the MAX9856 signals receipt of the data byte. The address pointer autoincrements to the next register address after each received data byte. This autoincrement feature allows a master to write to sequential registers within one continuous frame. Figure 12 illustrates how to write to multiple registers with one frame. The master signals the end of transmission by issuing a STOP condition.

Register addresses greater than 0x1C are reserved. Do not write to these addresses.

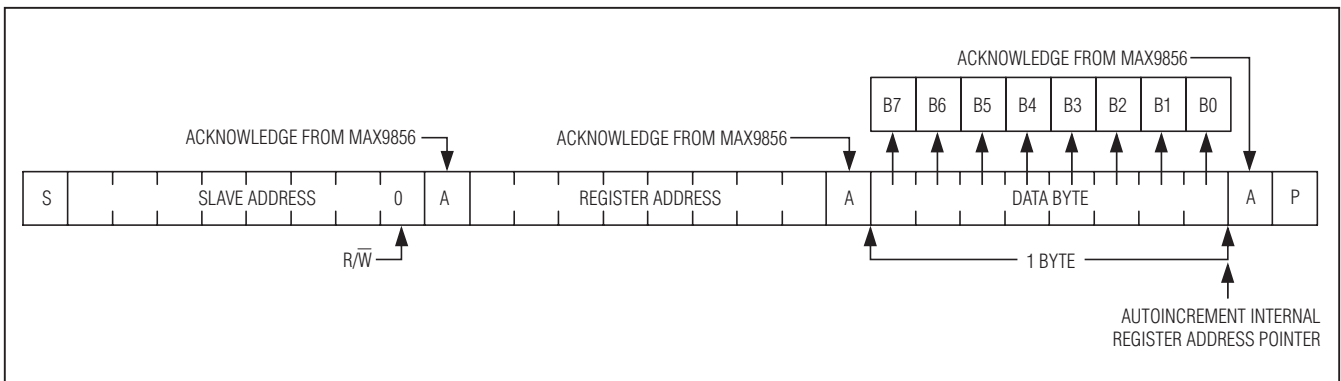

Figure 11. Writing 1 Byte of Data to the MAX9856

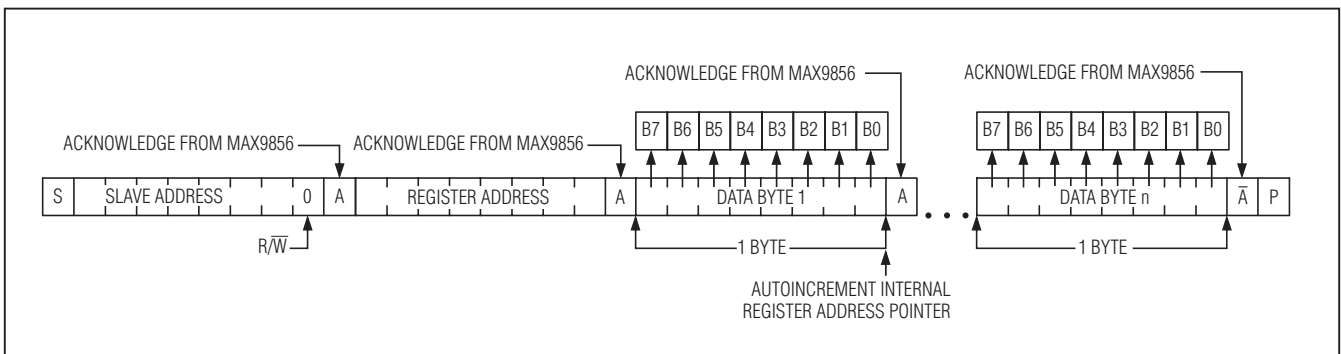

Figure 12. Writing n Bytes of Data to the MAX9856

Low-Power Audio CODEC with DirectDrive Headphone Amplifiers

Read Data Format

Send the slave address with the R/\bar{W} bit set to 1 to initiate a read operation. The MAX9856 acknowledges receipt of its slave address by pulling SDA low during the 9th SCL clock pulse. A START command followed by a read command resets the address pointer to register 0x00. The first byte transmitted from the MAX9856 is the contents of register 0x00. Transmitted data is valid on the rising edge of SCL. The address pointer autoincrements after each read data byte. This autoincrement feature allows all registers to be read sequentially within one continuous frame. A STOP condition can be issued after any number of read data bytes. If a STOP condition is issued, followed by another read operation, the first data byte to be read is from register 0x00.

The address pointer can be preset to a specific register before a read command is issued. The master presets the address pointer by first sending the MAX9856's slave address with the R/\bar{W} bit set to 0 followed by the register address. A REPEATED START condition is then sent followed by the slave address with the R/\bar{W} bit set to 1. The MAX9856 then transmits the contents of the specified register. The address pointer autoincrements after transmitting the first byte. The master acknowledges receipt of each read byte during the acknowledge clock pulse. The master must acknowledge all correctly received bytes except the last byte. The final byte must be followed by a not acknowledge from the master and then a STOP condition. Figure 13 illustrates the frame format for reading 1 byte from the MAX9856. Figure 14 illustrates the frame format for reading multiple bytes from the MAX9856.

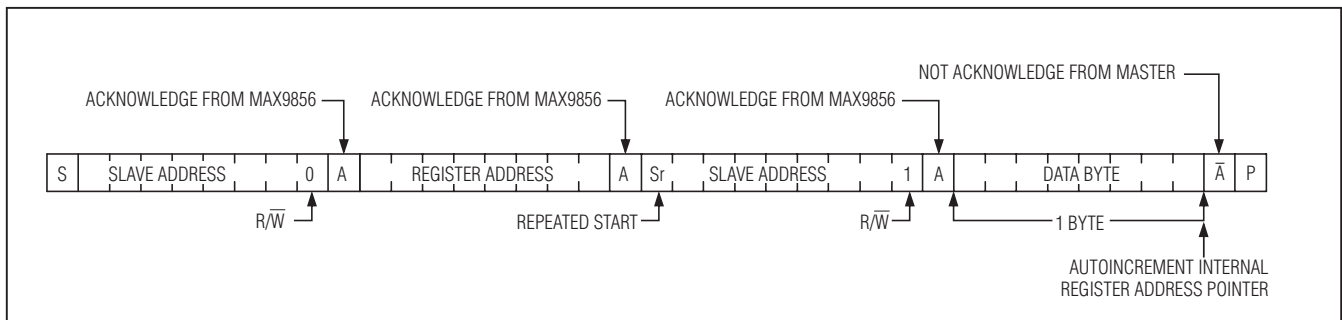

Figure 13. Reading 1 Indexed Byte of Data from the MAX9856

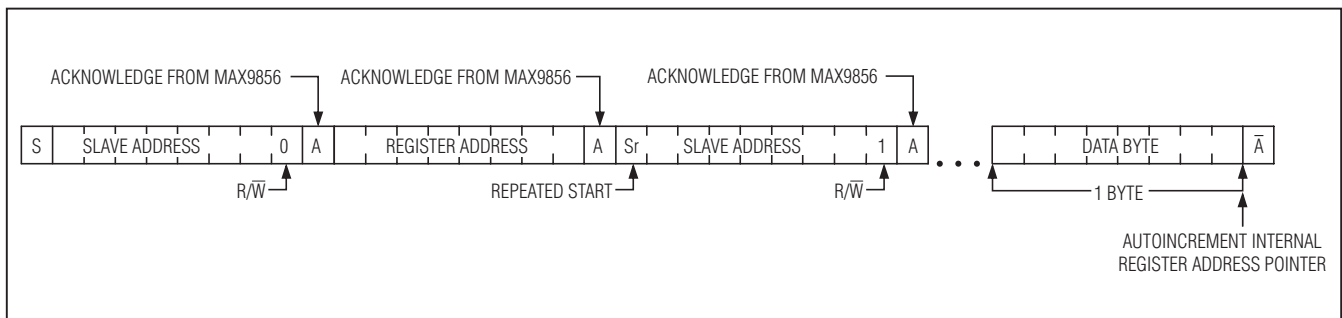

Figure 14. Reading n Bytes of Indexed Data from the MAX9856

Low-Power Audio CODEC with DirectDrive Headphone Amplifiers

MAX9856

PCB Layout and Bypassing

Proper layout and grounding are essential for optimum performance. Use large traces for the power-supply inputs and amplifier outputs to minimize losses due to parasitic trace resistance. Proper grounding improves audio performance, minimizes crosstalk between channels, and prevents any switching noise from coupling into the audio signal. Connect AGND, DGND, CPGND, and PGND together at a single point on the PCB using the star grounding technique. Route DGND, CPGND, and all traces that carry switching transients or digital signals separately from AGND and the analog audio signal paths. Ground all components associated with the charge pump to CPGND (CPVSS bypassing and CPVDD bypassing). Connect all digital I/O termination to DGND including DVDD and DVDDS2 bypassing. Bypass REF and MICBIAS to AGND.

Connect PVSS and SVSS together at the device and place the charge-pump hold capacitor (C2) as close to SVSS as possible and ground to CPGND. Bypass CPVDD with a 1µF capacitor to CPGND and place the bypass capacitor as close to the device as possible.

The MAX9856 thin QFN package features an exposed thermal pad on its underside. This pad lowers the package's thermal resistance by providing a direct heat conduction path from the die to the PCB. Connect the exposed thermal pad to AGND.

An evaluation kit (EV Kit) is available to provide an example layout for the MAX9856. The EV Kit allows quick setup of the MAX9856 and includes easy-to-use software allowing all internal registers to be controlled.

Pin Configuration

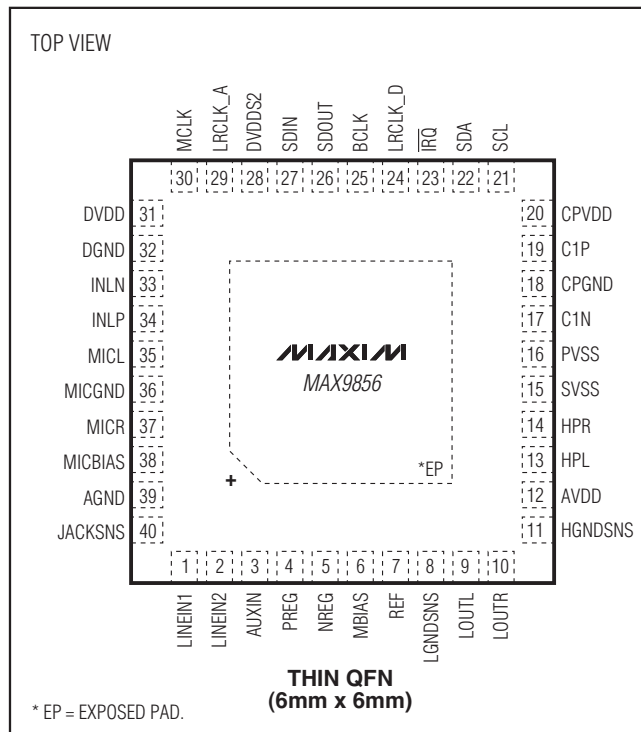

Chip Information

PROCESS: BiCMOS

Low-Power Audio CODEC with DirectDrive Headphone Amplifiers

Package Information

For the latest package outline information and land patterns (footprints), go to www.maxim-ic.com/packages. Note that a "+", "#", or "-" in the package code indicates RoHS status only. Package drawings may show a different suffix character, but the drawing pertains to the package regardless of RoHS status.

PACKAGE TYPE	PACKAGE CODE	OUTLINE NO.	LAND PATTERN NO.
40 TQFN	T4066+5	21-0141	90-0055

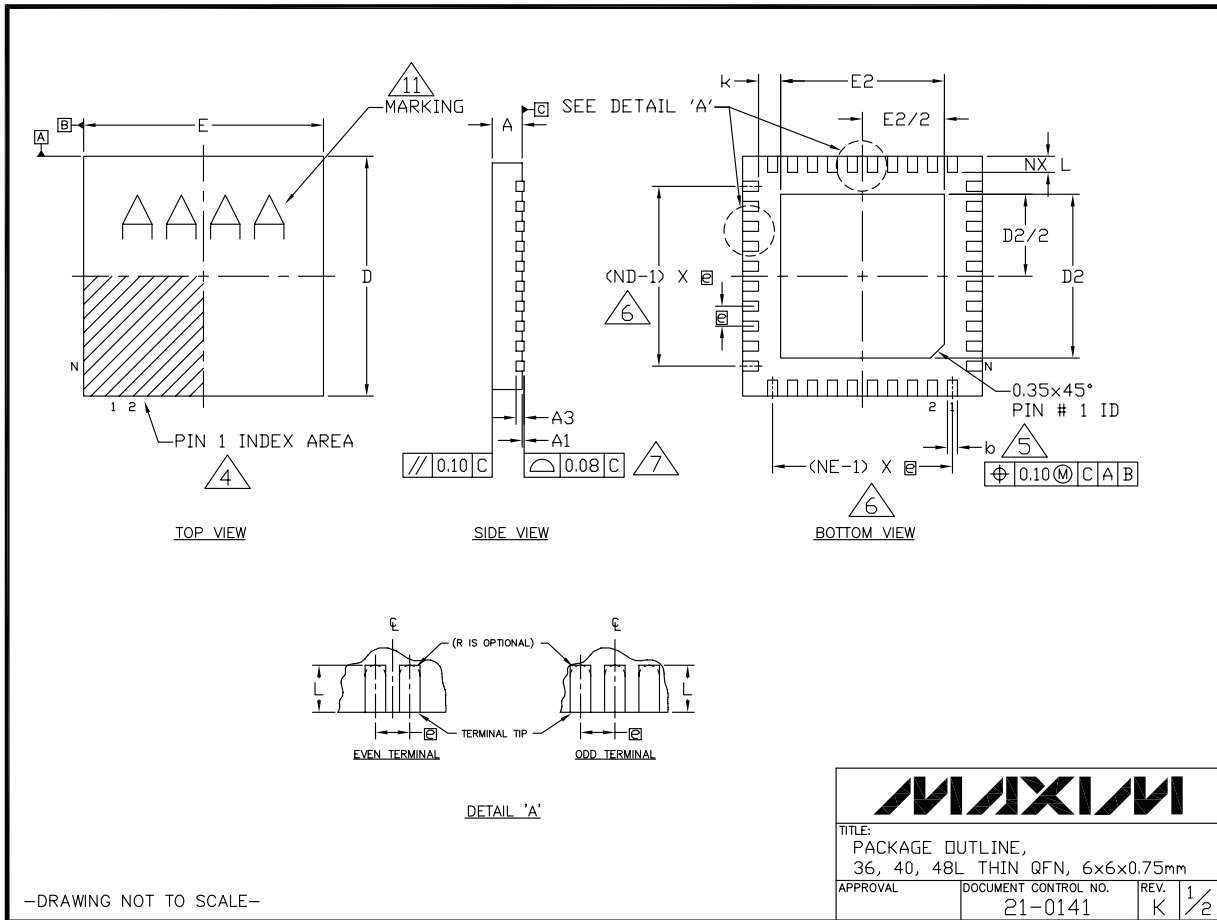

Low-Power Audio CODEC with DirectDrive Headphone Amplifiers

Package Information (continued)

For the latest package outline information and land patterns (footprints), go to www.maxim-ic.com/packages. Note that a "+", "#", or "-" in the package code indicates RoHS status only. Package drawings may show a different suffix character, but the drawing pertains to the package regardless of RoHS status.

MAX9856

COMMON DIMENSIONS									
PKG. SYMBOL	36L 6x6			40L 6x6			48L 6x6		
	MIN.	NOM.	MAX.	MIN.	NOM.	MAX.	MIN.	NOM.	MAX.
A	0.70	0.75	0.80	0.70	0.75	0.80	0.70	0.75	0.80
A1	0	0.02	0.05	0	0.02	0.05	0	-	0.05
A3	0.20 REF.			0.20 REF.			0.20 REF.		
b	0.20	0.25	0.30	0.20	0.25	0.30	0.15	0.20	0.25
D	5.90	6.00	6.10	5.90	6.00	6.10	5.90	6.00	6.10
E	5.90	6.00	6.10	5.90	6.00	6.10	5.90	6.00	6.10
e	0.50 BSC.			0.50 BSC.			0.40 BSC.		
k	0.25	-	-	0.25	-	-	0.25	-	-
L	0.35	0.50	0.65	0.30	0.40	0.50	0.30	0.40	0.50
N	36			40			48		
ND	9			10			12		
NE	9			10			12		
JEDEC	WJJD-1			WJJD-2			-		

EXPOSED PAD VARIATIONS						
PKG. CODES	D2			E2		
	MIN.	NOM.	MAX.	MIN.	NOM.	MAX.
T3666-2	3.60	3.70	3.80	3.60	3.70	3.80
T3666-3	3.60	3.70	3.80	3.60	3.70	3.80
T3666N-1	3.60	3.70	3.80	3.60	3.70	3.80
T3666MN-1	3.60	3.70	3.80	3.60	3.70	3.80
T4066-2	4.00	4.10	4.20	4.00	4.10	4.20
T4066-3	4.00	4.10	4.20	4.00	4.10	4.20
T4066-5	4.00	4.10	4.20	4.00	4.10	4.20
T4866-1	4.40	4.50	4.60	4.40	4.50	4.60
T4866N-1	4.40	4.50	4.60	4.40	4.50	4.60
T4866-2	4.40	4.50	4.60	4.40	4.50	4.60
T4066MN-5	4.00	4.10	4.20	4.00	4.10	4.20

NOTES:

- ALL DIMENSIONS ARE IN MILLIMETERS, ANGLES IN DEGREES UNLESS OTHERWISE SPECIFIED.
- DIMENSIONING & TOLERANCING CONFORM TO ASME Y14.5M-1994.
- MATERIAL MUST COMPLY WITH BANNED AND RESTRICTED SUBSTANCES SPEC # 10-0131.
- THE TERMINAL #1 IDENTIFIER AND TERMINAL NUMBERING CONVENTION SHALL CONFORM TO JEDEC 95-1 SPP-012. DETAILS OF TERMINAL #1 IDENTIFIER ARE OPTIONAL, BUT MUST BE LOCATED WITHIN THE ZONE INDICATED. THE TERMINAL #1 IDENTIFIER MAY BE EITHER A MOLD OR MARKED FEATURE.
- DIMENSION b APPLIES TO METALLIZED TERMINAL AND IS MEASURED BETWEEN 0.25mm AND 0.30mm FROM TERMINAL TIP.
- ND AND NE REFER TO THE NUMBER OF TERMINALS ON EACH D AND E SIDE, RESPECTIVELY.
- COPLANARITY APPLIES TO THE EXPOSED HEAT SINK SLUG AS WELL AS THE TERMINALS.
- DRAWING CONFORMS TO JEDEC MO220, EXCEPT FOR 0.4mm LEAD PITCH; PACKAGE T4866.
- N IS THE TOTAL NUMBER OF TERMINALS.
- WARPAGE SHALL NOT EXCEED 0.10mm.
- MARKING IS FOR PACKAGE ORIENTATION PURPOSE ONLY.
- NUMBER OF LEADS SHOWN FOR REFERENCE ONLY.
- ALL DIMENSIONS APPLY TO BOTH LEADED (-) AND PbFREE (+) PKG. CODES.

-DRAWING NOT TO SCALE-

TITLE: PACKAGE OUTLINE, 36, 40, 48L THIN QFN, 6x6x0.75mm		
APPROVAL	DOCUMENT CONTROL NO. 21-0141	REV. K 2/2

Low-Power Audio CODEC with DirectDrive Headphone Amplifiers

Revision History

REVISION NUMBER	REVISION DATE	DESCRIPTION	PAGES CHANGED
0	3/08	Initial release	—
1	9/08	Added new Note 1 to EC table	2-10
2	12/11	Added automotive qualified part information to data sheet	1, 2

Maxim cannot assume responsibility for use of any circuitry other than circuitry entirely embodied in a Maxim product. No circuit patent licenses are implied. Maxim reserves the right to change the circuitry and specifications without notice at any time. The parametric values (min and max limits) shown in the Electrical Characteristics table are guaranteed. Other parametric values quoted in this data sheet are provided for guidance.

46 **Maxim Integrated Products, 120 San Gabriel Drive, Sunnyvale, CA 94086 408-737-7600**

© 2011 Maxim Integrated Products

Maxim is a registered trademark of Maxim Integrated Products, Inc.