

## EMI filter with SWP protection for SIM interface

Datasheet – production data

### Features

- Lead-free package
- Very low PCB space consumption
- Very thin package: < 0.55 mm after reflow
- High efficiency in ESD suppression IEC6 1000-4-2 level 4
- High reliability offered by monolithic integration
- High reduction of parasitic elements through integration and WLCSP packaging

### Complies with the following standards:

- IEC 61000-4-2 level 4
  - ± 15 kV (air discharge)
  - ± 8 kV (contact discharge)

### Application

- Mobile phones

### Description

The EMIF03-SIM05F3 is a highly integrated device designed to protect SIM interface and SWP line against ESD transients and EMI emission.

The device is the ideal fit for applications using NFC.

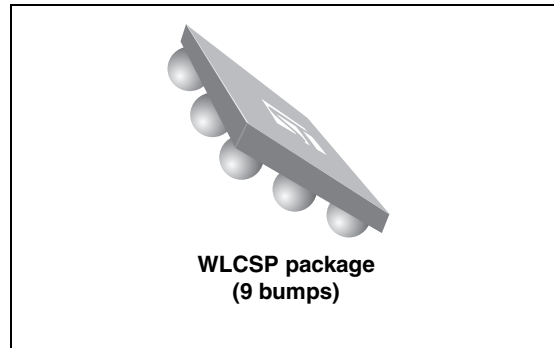

Figure 1. Pin configuration (bump side)

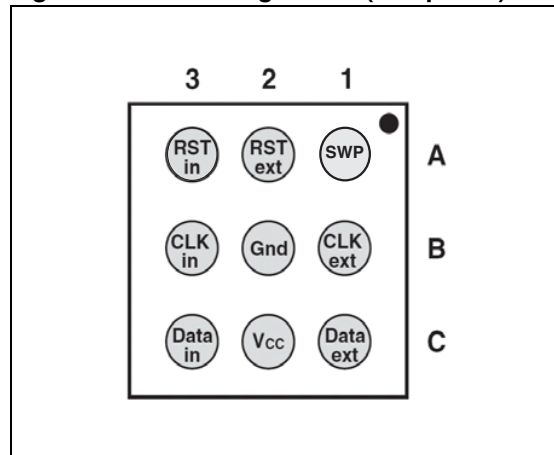
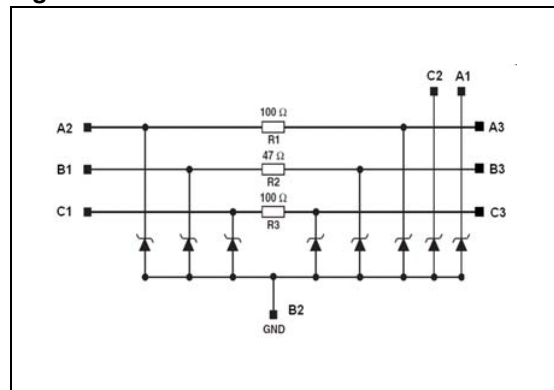

Figure 2. Functional schematic



# 1 Characteristics

**Table 1. Absolute maximum ratings ( $T_{amb} = 25\text{ }^{\circ}\text{C}$ )**

Symbol	Parameter	Value	Unit	
$V_{PP}$	<b>Internal pins (A3, B3, C3):</b>			
	ESD discharge IEC 61000-4-2 <sup>(1)</sup> , level 1			
	Air discharge	2	kV	
	Contact discharge	2		
	<b>External pins (A1, A2, B1, C1, C2):</b>			
	ESD discharge IEC 61000-4-2, level 4			
Air discharge	16			
Contact discharge	16			
$T_j$	Maximum junction temperature	150	$^{\circ}\text{C}$	
$T_{op}$	Operating temperature range	- 30 to + 85		
$T_{stg}$	Storage temperature range	- 55 to 150		

1. Measurements done on IEC 61000-4-2 test bench. For further details see Application note AN3353, "IEC 61000-4-2 standard testing".

**Figure 3. Electrical characteristics (definitions)**

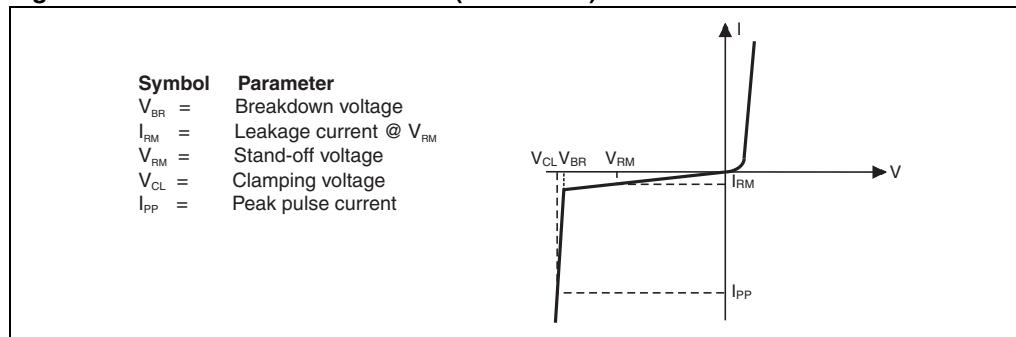

**Table 2. Electrical characteristics ( $T_{amb} = 25\text{ }^{\circ}\text{C}$ )**

Symbol	Test conditions	Min.	Typ.	Max.	Unit
$I_{RM}$	$V_{RM} = 3\text{ V}$			100	nA
$V_{BR}$	$I_R = 1\text{ mA}$	6			V
R1, R3	RST, DATA serial resistor		100		$\Omega$
R2	CLK serial resistor		47		
$C_{line}$	Line capacitance on RST, DATA, CLK lines $V_{line} = 0\text{ V}$ , $V_{osc} = 30\text{ mV}$ , $F = 1\text{ MHz}$ (measured under zero light conditions)		12		pF
$C_{SWP}$	Line capacitance on SWP line $V_{line} = 0\text{ V}$ , $V_{osc} = 30\text{ mV}$ , $F = 1\text{ MHz}$ (measured under zero light conditions)		2	3	pF

Figure 4. Attenuation measurements C1-C3, Figure 5. Attenuation measurements A1-C2  
A2-A3, B1-B3

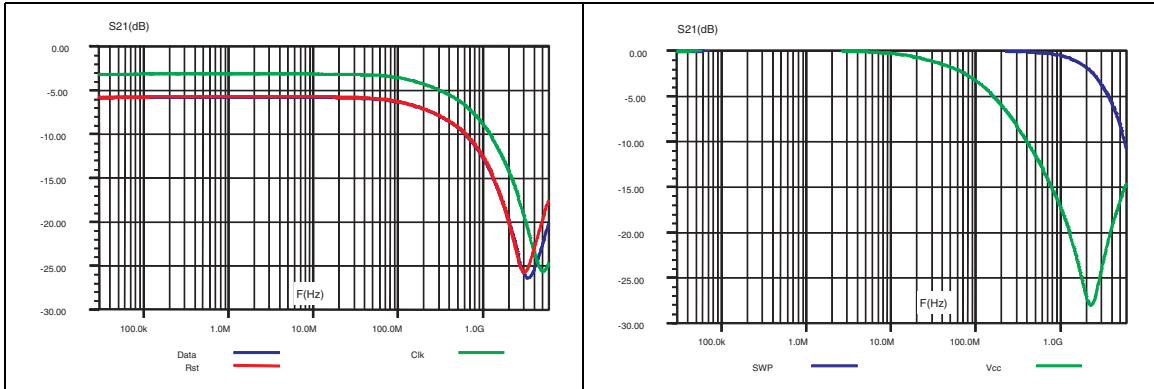

Figure 6. Analog Xtalk measurements

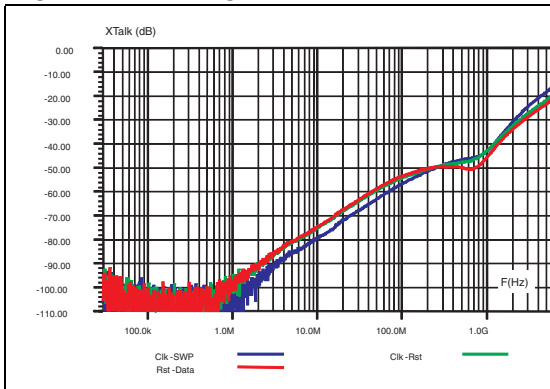

Figure 7. Digital crosstalk measurements

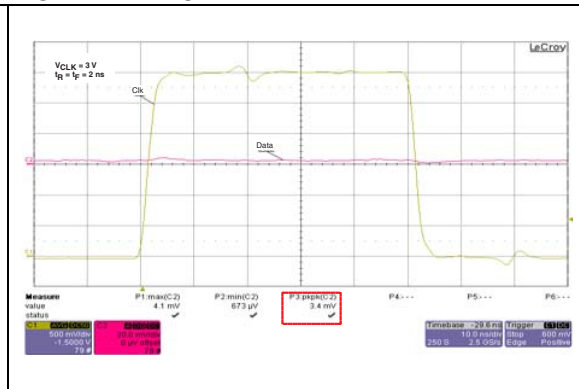

Figure 8. Dynamic characteristic (SWP)

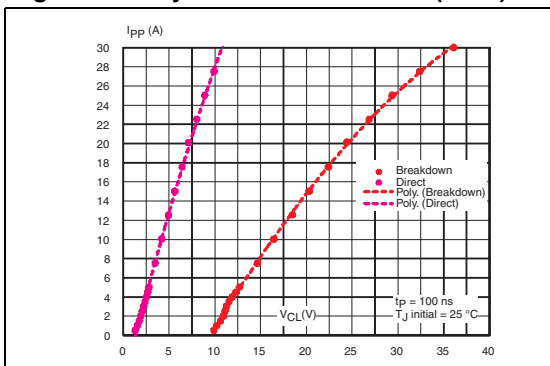

Figure 9. Dynamic characteristic (VCC)

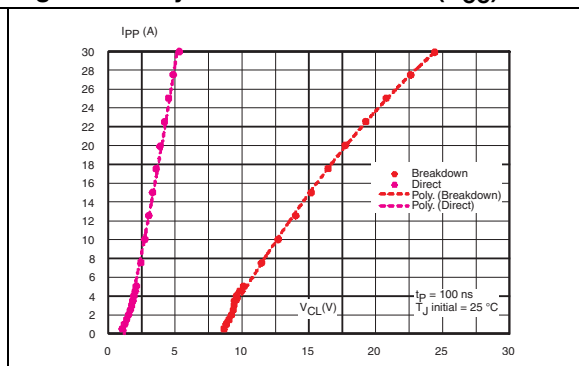

Figure 10. ESD response to IEC 61000-4-2 (+8 kV contact discharge) CLK line

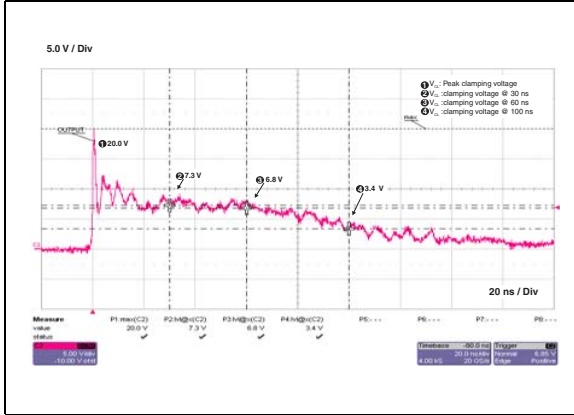

Figure 11. ESD response to IEC 61000-4-2 (-8 kV contact discharge) CLK line

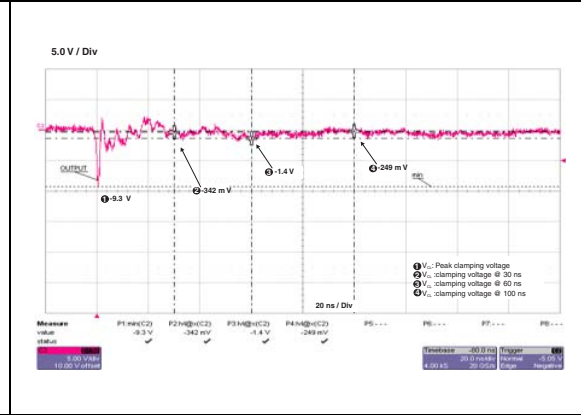

Figure 12. ESD response to IEC 61000-4-2 (+8 kV contact discharge) DATA line

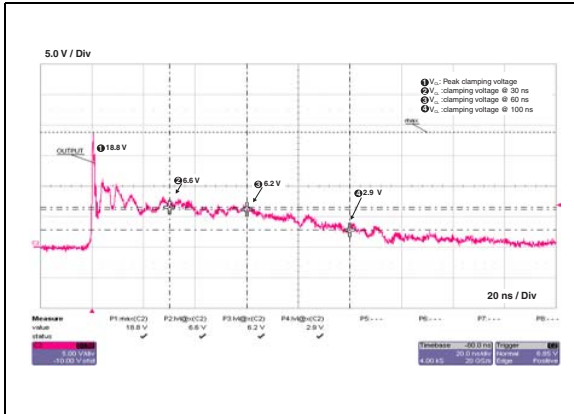

Figure 13. ESD response to IEC 61000-4-2 (-8 kV contact discharge) DATA line

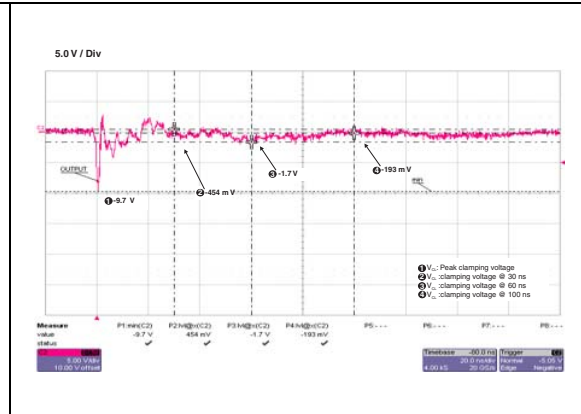

Figure 14. ESD response to IEC 61000-4-2 (+8 kV contact discharge) SWP line

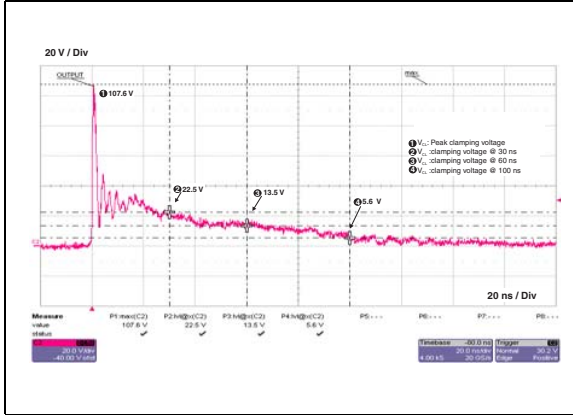

Figure 15. ESD response to IEC 61000-4-2 (-8 kV contact discharge) SWP line

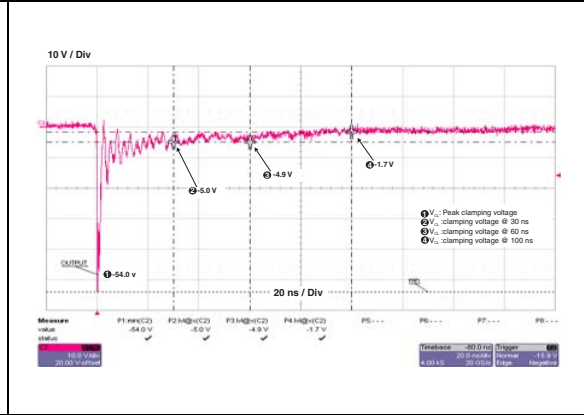

Figure 16. ESD response to IEC 61000-4-2 (+8 kV contact discharge) V<sub>CC</sub> line

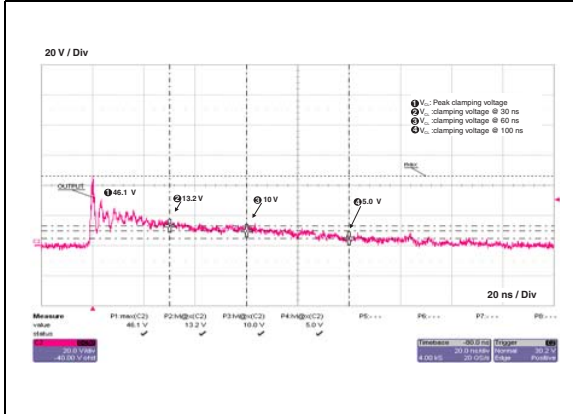
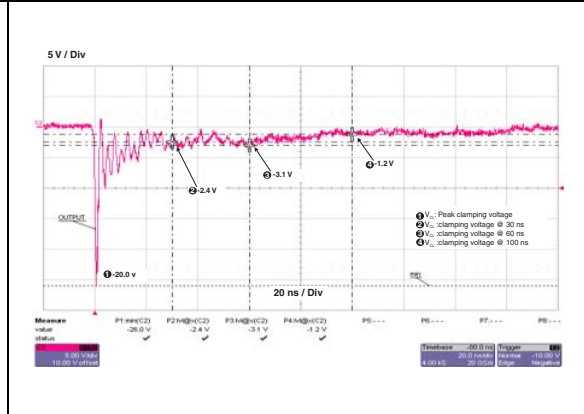
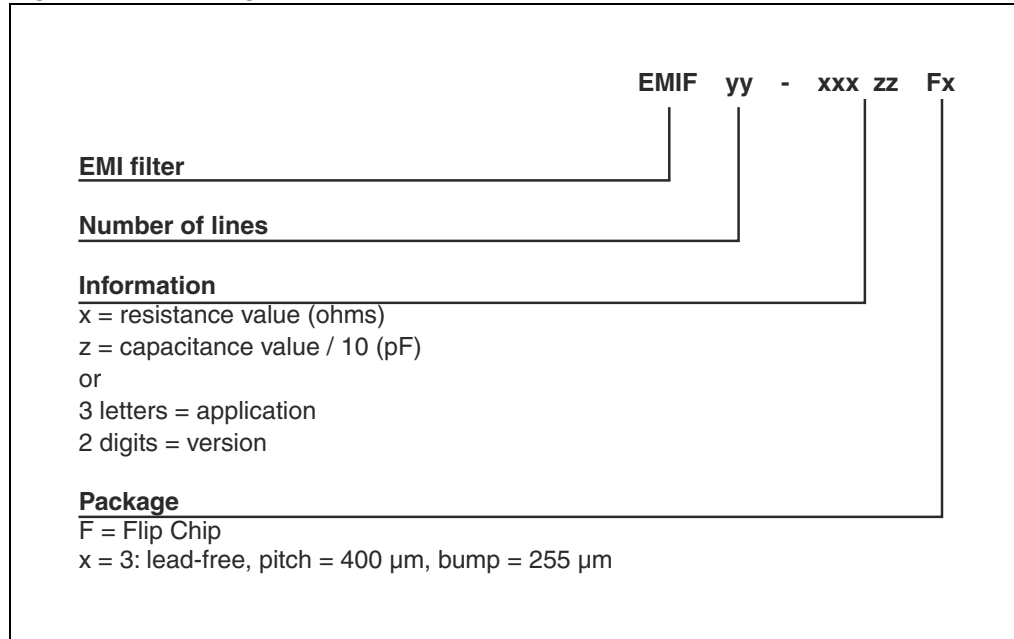

Figure 17. ESD response to IEC 61000-4-2 (-8 kV contact discharge) V<sub>CC</sub> line



## 2 Ordering information scheme

Figure 18. Ordering information scheme



### 3 Package information

In order to meet environmental requirements, ST offers these devices in different grades of ECOPACK® packages, depending on their level of environmental compliance. ECOPACK® specifications, grade definitions and product status are available at: [www.st.com](http://www.st.com). ECOPACK® is an ST trademark.

Figure 19. WLCSP package dimensions

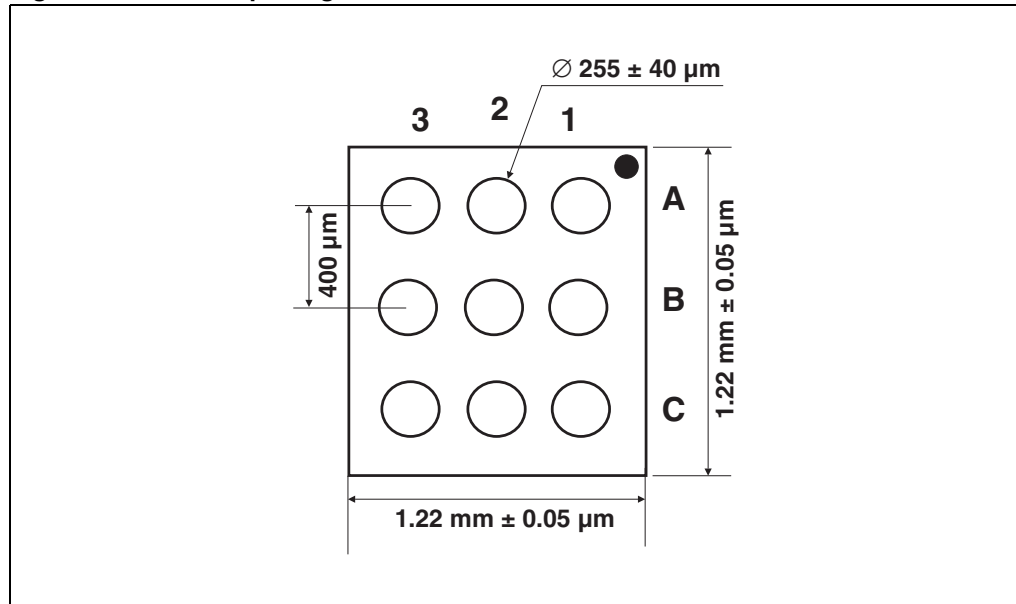
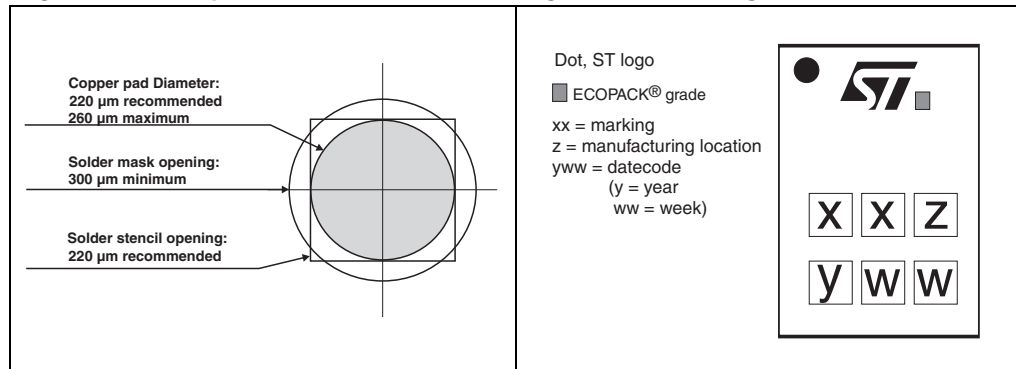
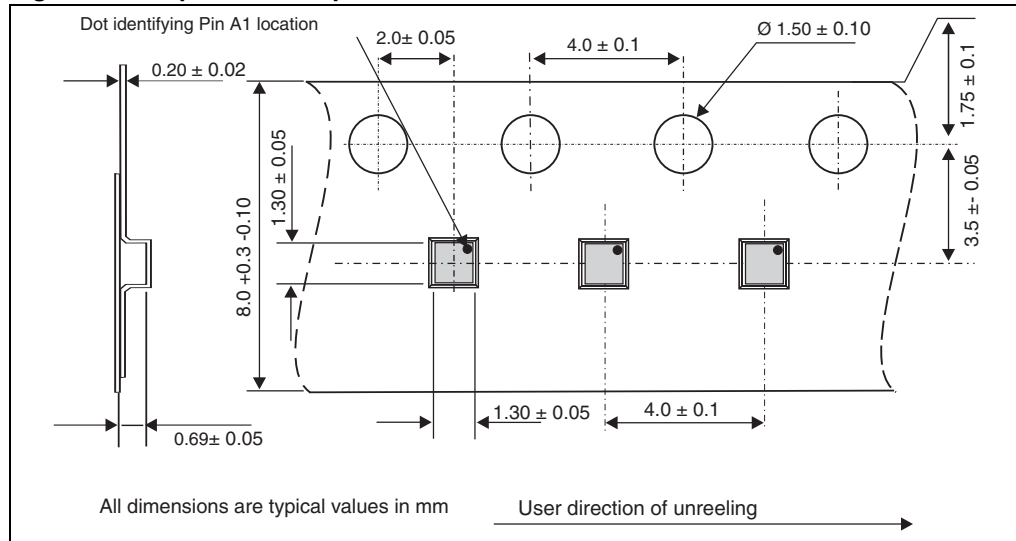

Figure 20. Footprint recommendations      Figure 21. Marking



**Figure 22. Tape and reel specification**



Note: *More information is available in the application notes:  
 AN2348, "IPAD™ 400 µm Flip Chip: package description and recommendations for use"  
 AN1751, "EMI filters: recommendations and measurements"*

## 4 Ordering information

**Table 3. Ordering information**

Order code	Marking	Package	Weight	Base qty	Delivery mode
EMIF03-SIM05F3	LB	WLCSP	1.9 mg	5000	Tape and reel (7")

## 5 Revision history

**Table 4. Document revision history**

Date	Revision	Changes
12-Nov-2012	1	Initial release.



**Please Read Carefully:**

Information in this document is provided solely in connection with ST products. STMicroelectronics NV and its subsidiaries ("ST") reserve the right to make changes, corrections, modifications or improvements, to this document, and the products and services described herein at any time, without notice.

All ST products are sold pursuant to ST's terms and conditions of sale.

Purchasers are solely responsible for the choice, selection and use of the ST products and services described herein, and ST assumes no liability whatsoever relating to the choice, selection or use of the ST products and services described herein.

No license, express or implied, by estoppel or otherwise, to any intellectual property rights is granted under this document. If any part of this document refers to any third party products or services it shall not be deemed a license grant by ST for the use of such third party products or services, or any intellectual property contained therein or considered as a warranty covering the use in any manner whatsoever of such third party products or services or any intellectual property contained therein.

**UNLESS OTHERWISE SET FORTH IN ST'S TERMS AND CONDITIONS OF SALE ST DISCLAIMS ANY EXPRESS OR IMPLIED WARRANTY WITH RESPECT TO THE USE AND/OR SALE OF ST PRODUCTS INCLUDING WITHOUT LIMITATION IMPLIED WARRANTIES OF MERCHANTABILITY, FITNESS FOR A PARTICULAR PURPOSE (AND THEIR EQUIVALENTS UNDER THE LAWS OF ANY JURISDICTION), OR INFRINGEMENT OF ANY PATENT, COPYRIGHT OR OTHER INTELLECTUAL PROPERTY RIGHT.**

**UNLESS EXPRESSLY APPROVED IN WRITING BY TWO AUTHORIZED ST REPRESENTATIVES, ST PRODUCTS ARE NOT RECOMMENDED, AUTHORIZED OR WARRANTED FOR USE IN MILITARY, AIR CRAFT, SPACE, LIFE SAVING, OR LIFE SUSTAINING APPLICATIONS, NOR IN PRODUCTS OR SYSTEMS WHERE FAILURE OR MALFUNCTION MAY RESULT IN PERSONAL INJURY, DEATH, OR SEVERE PROPERTY OR ENVIRONMENTAL DAMAGE. ST PRODUCTS WHICH ARE NOT SPECIFIED AS "AUTOMOTIVE GRADE" MAY ONLY BE USED IN AUTOMOTIVE APPLICATIONS AT USER'S OWN RISK.**

Resale of ST products with provisions different from the statements and/or technical features set forth in this document shall immediately void any warranty granted by ST for the ST product or service described herein and shall not create or extend in any manner whatsoever, any liability of ST.

ST and the ST logo are trademarks or registered trademarks of ST in various countries.

Information in this document supersedes and replaces all information previously supplied.

The ST logo is a registered trademark of STMicroelectronics. All other names are the property of their respective owners.

© 2012 STMicroelectronics - All rights reserved

STMicroelectronics group of companies

Australia - Belgium - Brazil - Canada - China - Czech Republic - Finland - France - Germany - Hong Kong - India - Israel - Italy - Japan - Malaysia - Malta - Morocco - Philippines - Singapore - Spain - Sweden - Switzerland - United Kingdom - United States of America

[www.st.com](http://www.st.com)

