

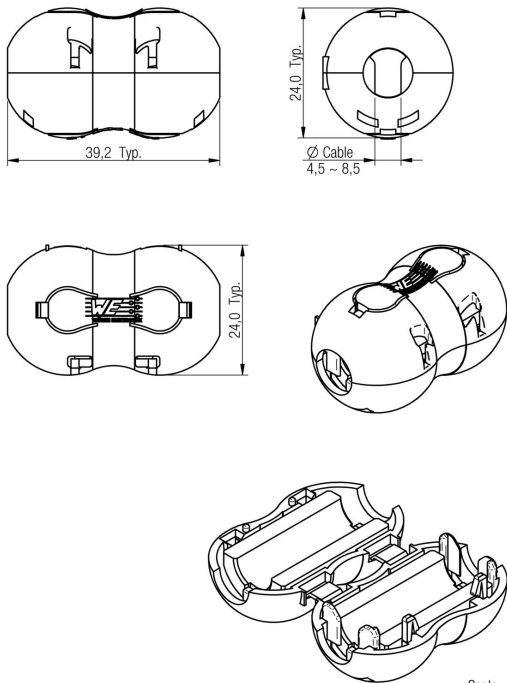

**A Dimensions: [mm]**



Scale - 1:1

**B Applicable Cable Diameter: [mm]**

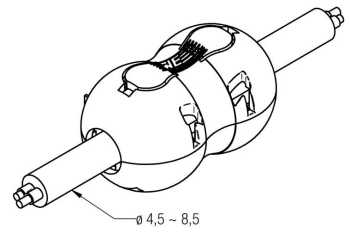

Scale - 1:1

**D Electrical Properties:**

| Properties                 | Test conditions |   | Value | Unit | Tol. |
|----------------------------|-----------------|---|-------|------|------|
| Impedance @ 25 MHz 1 turn  | 25 MHz          | Z | 120   | Ω    | ±25% |
| Impedance @ 100 MHz 1 turn | 100 MHz         | Z | 200   | Ω    | ±25% |

**E General information:**

Storage Temperature (before assembly): 0°C to +40°C  
 Operating Temperature: -25°C to +105°C  
 Test conditions of Electrical Properties: 20°C, 33% RH  
 if not specified differently

**Additional Features**

|                            |       |
|----------------------------|-------|
| Safety key to lock/ uncock | 74271 |
|----------------------------|-------|

|     |      |    |         |   |   |   |      |
|-----|------|----|---------|---|---|---|------|
|     |      |    |         | Projection  | DESCRIPTION   |   |      |
|     |      |    |         | Würth Elektronik eiSos GmbH & Co. KG<br>EMC & Inductive Solutions<br>Max-Eyth-Str. 1<br>74638 Waldenburg<br>Germany<br>Tel. +49 (0) 79 42 945 - 0<br>www.we-online.com<br>eiSos@we-online.com | <b>STAR-BUENO Snap Ferrite with optical closing control mechanism</b> |   |      |
|     |      |    |         |   | Order - No.   | COMPLIANT<br>RoHS&REACH<br>WÜRTH ELEKTRONIK | SIZE |
|     |      |    |         |   | <b>74275813</b>   |   | A4   |
| REV | DATE | BY | CHECKED |   |   |   |      |

This electronic component has been designed and developed for usage in general electronic equipment only. This product is not authorized for use in equipment where a higher safety standard and reliability standard is especially required or where a failure of the product is reasonably expected to cause severe personal injury or death, unless the parties have executed an agreement specifically governing such use. Moreover Würth Elektronik eiSos GmbH & Co KG products are neither designed nor intended for use in areas such as military, aerospace, aviation, nuclear control, submarine, transportation (automotive control, train control, ship control), transportation signal, disaster prevention, medical, public information network etc. Würth Elektronik eiSos GmbH & Co KG must be informed about the intent of such usage before the design-in stage. In addition, sufficient reliability evaluation checks for safety must be performed on every electronic component which is used in electrical circuits that require high safety and reliability functions or performance.



**D2 General Properties:**

|                        | Properties                  |         | Value   | Unit | Tol. |
|------------------------|-----------------------------|---------|---------|------|------|
| <b>Ferrite core</b>    | Material                    |         | 4 W 620 |      |      |
| <b>Ferrite core</b>    | Initial permeability        | $\mu_i$ | 620     |      | typ. |
| <b>Ferrite core</b>    | Curie temperature           | $T_C$   | 150     | °C   | typ. |
| <b>Plastic housing</b> | Colour                      |         | Grey    |      |      |
| <b>Plastic housing</b> | Flammability Classification |         | UL94-V0 |      |      |
| <b>Test cable</b>      | Applicable cable            |         | AWG26   |      |      |
| <b>Test cable</b>      | Applicable cable length     |         | 150     | mm   |      |

**F Typical Impedance Characteristics:**

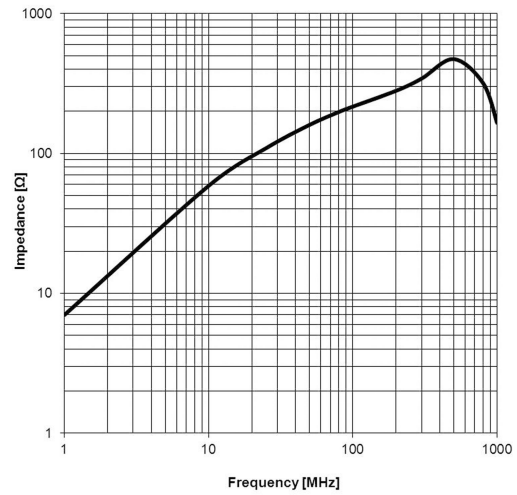

— Z

|     |            |     |         |  |   |   |
|-----|------------|-----|---------|--|---|---|
|     |            |     |         |  | Projection  | DESCRIPTION   |
|     |            |     |         |  |   | <b>STAR-BUENO Snap Ferrite with optical closing control mechanism</b> |
|     |            |     |         |  | Würth Elektronik eiSos GmbH & Co. KG<br>EMC & Inductive Solutions<br>Max-Eyth-Str. 1<br>74638 Waldenburg<br>Germany<br>Tel. +49 (0) 79 42 945 - 0<br>www.we-online.com<br>eiSos@we-online.com | Order.- No.<br><b>74275813</b>  |
| 2.1 | 2012-06-27 | SSt | SSt     |  |   |   |
| 2.0 | 2012-04-23 | SSt | SMu     |  |   |   |
| 1.0 | 2011-03-21 | SMu | -       |  |   | SIZE<br>A4  |
| REV | DATE       | BY  | CHECKED |  |   |   |

This electronic component has been designed and developed for usage in general electronic equipment only. This product is not authorized for use in equipment where a higher safety standard and reliability standard is especially required or where a failure of the product is reasonably expected to cause severe personal injury or death, unless the parties have executed an agreement specifically governing such use. Moreover Würth Elektronik eiSos GmbH & Co.KG products are neither designed nor intended for use in areas such as military, aerospace, aviation, nuclear control, submarine, transportation (automotive control, train control, ship control), transportation signal, disaster prevention, medical, public information network etc.. Würth Elektronik eiSos GmbH & Co. KG must be informed about the intent of such usage before the design-in stage. In addition, sufficient reliability evaluation checks for safety must be performed on every electronic component which is used in electrical circuits that require high safety and reliability functions or performance.



**I Cautions and Warnings:**

**The following conditions apply to all goods within the product series of WE-STAR BUENO of Würth Elektronik eiSos GmbH & Co. KG:**

**General:**

All recommendations according to the general technical specifications of the data sheet have to be complied with.

The disposal and operation of the product within ambient conditions which probably alloy or harm the component surface has to be avoided.

The packaging of the product is to encase the needed humidity of the plastic housing. To ensure the humidity level, the products have to be stored in this delivered packaging. If not, the products are losing their humidity. In this case you can re-condition the components according to the internal standard WE1883 to ensure the necessary humidity in the plastic.

To ensure the operating mode of the product, the ambient temperature at processing (when the part will be mounted on the cable) has to be in the range of 15 to 25 °C.

Before mounting, the part should be stored for one hour in this condition.



The responsibility for the applicability of customer specific products and the use in a particular customer design is always within the authority of the customer. All technical specifications for standard products do also apply for customer specific products.

Direct mechanical impact to the product and the forcible closing of this shall be prevented as the ferrite material of the ferrite body or the plastic housing could flake or in the worst case it could break.

**Product specific:**

Follow all instructions mentioned in the datasheet, especially:

- The cable diameter must be pointed out, otherwise no warranty will be sustained.
- Violation of the technical product specifications such as exceeding the nominal rated current will result in the loss of warranty.

|     |            |     |         |  |   |             |   |      |
|-----|------------|-----|---------|--|---|-------------|---|------|
|     |            |     |         |  | Projection   |             | DESCRIPTION   |      |
|     |            |     |         |  |   |             | <b>STAR-BUENO Snap Ferrite with optical closing control mechanism</b>   |      |
|     |            |     |         |  | Würth Elektronik eiSos GmbH & Co. KG<br>EMC & Inductive Solutions<br>Max-Eyth-Str. 1<br>74638 Waldenburg<br>Germany<br>Tel. +49 (0) 79 42 945 - 0<br>www.we-online.com<br>eiSos@we-online.com | Order - No. |  COMPLIANT<br>RoHS&REACH<br>WÜRTH ELEKTRONIK | SIZE |
|     |            |     |         |  |   |             | <b>74275813</b>   | A4   |
| 2.1 | 2012-06-27 | SSt | SSt     |  |   |             |   |      |
| 2.0 | 2012-04-23 | SSt | SMu     |  |   |             |   |      |
| 1.0 | 2011-03-21 | SMu | -       |  |   |             |   |      |
| REV | DATE       | BY  | CHECKED |  |   |             |   |      |

This electronic component has been designed and developed for usage in general electronic equipment only. This product is not authorized for use in equipment where a higher safety standard and reliability standard is especially required or where a failure of the product is reasonably expected to cause severe personal injury or death, unless the parties have executed an agreement specifically governing such use. Moreover Würth Elektronik eiSos GmbH & Co.KG products are neither designed nor intended for use in areas such as military, aerospace, aviation, nuclear control, submarine, transportation (automotive control, train control, ship control), transportation signal, disaster prevention, medical, public information network etc.. Würth Elektronik eiSos GmbH & Co.KG must be informed about the intent of such usage before the design-in stage. In addition, sufficient reliability evaluation checks for safety must be performed on every electronic component which is used in electrical circuits that require high safety and reliability functions or performance.



**J Important Notes:**

**The following conditions apply to all goods within the product range of Würth Elektronik eiSos GmbH & Co. KG:**

**1. General Customer Responsibility**

Some goods within the product range of Würth Elektronik eiSos GmbH & Co. KG contain statements regarding general suitability for certain application areas. These statements about suitability are based on our knowledge and experience of typical requirements concerning the areas, serve as general guidance and cannot be estimated as binding statements about the suitability for a customer application. The responsibility for the applicability and use in a particular customer design is always solely within the authority of the customer. Due to this fact it is up to the customer to evaluate, where appropriate to investigate and decide whether the device with the specific product characteristics described in the product specification is valid and suitable for the respective customer application or not.

**2. Customer Responsibility related to Specific, in particular Safety-Relevant Applications**

It has to be clearly pointed out that the possibility of a malfunction of electronic components or failure before the end of the usual lifetime cannot be completely eliminated in the current state of the art, even if the products are operated within the range of the specifications.

In certain customer applications requiring a very high level of safety and especially in customer applications in which the malfunction or failure of an electronic component could endanger human life or health it must be ensured by most advanced technological aid of suitable design of the customer application that no injury or damage is caused to third parties in the event of malfunction or failure of an electronic component.

**3. Best Care and Attention**

Any product-specific notes, warnings and cautions must be strictly observed.

**4. Customer Support for Product Specifications**

Some products within the product range may contain substances which are subject to restrictions in certain jurisdictions in order to serve specific technical requirements. Necessary information is available on request. In this case the field sales engineer or the internal sales person in charge should be contacted who will be happy to support in this matter.

**5. Product R&D**

Due to constant product improvement product specifications may change from time to time. As a standard reporting procedure of the Product Change Notification (PCN) according to the JEDEC-Standard inform about minor and major changes. In case of further queries regarding the PCN, the field sales engineer or the internal sales person in charge should be contacted. The basic responsibility of the customer as per Section 1 and 2 remains unaffected.

**6. Product Life Cycle**

Due to technical progress and economical evaluation we also reserve the right to discontinue production and delivery of products. As a standard reporting procedure of the Product Termination Notification (PTN) according to the JEDEC-Standard we will inform at an early stage about inevitable product discontinuance. According to this we cannot guarantee that all products within our product range will always be available. Therefore it needs to be verified with the field sales engineer or the internal sales person in charge about the current product availability expectancy before or when the product for application design-in disposal is considered.



The approach named above does not apply in the case of individual agreements deviating from the foregoing for customer-specific products.

**7. Property Rights**

All the rights for contractual products produced by Würth Elektronik eiSos GmbH & Co. KG on the basis of ideas, development contracts as well as models or templates that are subject to copyright, patent or commercial protection supplied to the customer will remain with Würth Elektronik eiSos GmbH & Co. KG.

**8. General Terms and Conditions**

Unless otherwise agreed in individual contracts, all orders are subject to the current version of the "General Terms and Conditions of Würth Elektronik eiSos Group", last version available at [www.we-online.com](http://www.we-online.com).

|     |            |     |         |   |   |   |      |
|-----|------------|-----|---------|---|---|---|------|
|     |            |     |         | Projection   | DESCRIPTION   |   |      |
|     |            |     |         | Würth Elektronik eiSos GmbH & Co. KG<br>EMC & Inductive Solutions<br>Max-Eyth-Str. 1<br>74638 Waldenburg<br>Germany<br>Tel. +49 (0) 79 42 945 - 0<br>www.we-online.com<br>eiSos@we-online.com | <b>STAR-BUENO Snap Ferrite with optical closing control mechanism</b> |   |      |
| 2.1 | 2012-06-27 | SSt | SSt     |   | Order.- No.   |  COMPLIANT<br>RoHS&REACH<br>WÜRTH ELEKTRONIK | SIZE |
| 2.0 | 2012-04-23 | SSt | SMu     |   | <b>74275813</b>   |  COMPLIANT<br>RoHS&REACH<br>WÜRTH ELEKTRONIK | A4   |
| 1.0 | 2011-03-21 | SMu | -       |   |   |   |      |
| REV | DATE       | BY  | CHECKED |   |   |   |      |

This electronic component has been designed and developed for usage in general electronic equipment only. This product is not authorized for use in equipment where a higher safety standard and reliability standard is especially required or where a failure of the product is reasonably expected to cause severe personal injury or death, unless the parties have executed an agreement specifically governing such use. Moreover Würth Elektronik eiSos GmbH & Co KG products are neither designed nor intended for use in areas such as military, aerospace, aviation, nuclear control, submarine, transportation (automotive control), train control, ship control, transportation signal, disaster prevention, medical, public information network etc.. Würth Elektronik eiSos GmbH & Co KG must be informed about the intent of such usage before the design-in stage. In addition, sufficient reliability evaluation checks for safety must be performed on every electronic component which is used in electrical circuits that require high safety and reliability functions or performance.