

Ferrite EMI Cable Cores

Electromagnetic Interference Solutions



Laird
TECHNOLOGIES®

Innovative **Technology**
for a **Connected** World

www.lairdtech.com

ABOUT LAIRD TECHNOLOGIES

Laird Technologies designs and manufactures customized, performance-critical products for wireless and other advanced electronics applications.

The company is a global market leader in the design and supply of electromagnetic interference (EMI) shielding, thermal management products, mechanical actuation systems, signal integrity components, and wireless antennae solutions, as well as radio frequency (RF) modules and systems.

Laird Technologies is the world leader in the design and manufacture of customized, performance-critical products for wireless and other advanced electronics applications. Laird Technologies partners with its customers to customize product solutions for applications in many industries including:

- Network Equipment
- Handsets
- Telecommunications
- Data Transfer & Information Technology
- Computers
- Automotive Electronics
- Aerospace
- Defense
- Medical Equipment
- Consumer Electronics
- Industrial

Laird Technologies offers its customers unique product solutions, dedication to research and development, as well as a seamless network of manufacturing and customer support facilities across the globe.

ANTENNAS & RECEPTION

WIRELESS REMOTE CONTROL

EMI SOLUTIONS

THERMAL MANAGEMENT

WIRELESS M2M & TELEMATICS



Innovative **Technology**
for a **Connected** World

TABLE OF CONTENTS



Ferrite Material Impedance Comparison	4
Design & Selection "Rules of Thumb"	4
High Frequency (HFB-) Cylindrical Cores	5
High Frequency (HFA-) Split, Snap-On Cores	6
Broadband (28B-) Cylindrical Cores	7
Broadband (28A-) Split, Snap-On Cores	10



SORTED QUICK REFERENCE CHARTS

Broadband (28B- and 28A-) Cable Cores	12
Low Frequency (LFB-) Cylindrical Cores	16
Broadband (28R-) Ribbon & Flex Cable Cores	17
Broadband (28S-) Split Ribbon & Flex Cable Cores	21

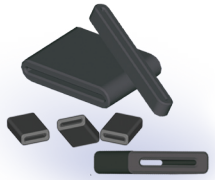

SORTED QUICK REFERENCE CHARTS

Broadband (28R- and 28S-) Ribbon Cores	23
Ferrite EMI Disks & Plates	27

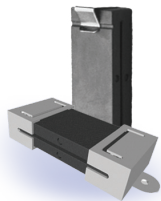

All parts listed in this catalog are lead free and RoHS compliant.

This catalog contains a limited selection of Laird Technologies cable core products. Refer to www.lairdtech.com for other cable core products not included in this cable core catalog.

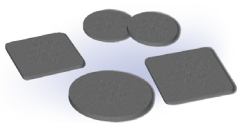

FERRITE MATERIAL COMPARISON

LF, 28 & HF MATERIAL IMPEDANCE VS FREQUENCY (300 KHz - 2 GHz) Impedance Materials for Cable & Wiring Harness Cores

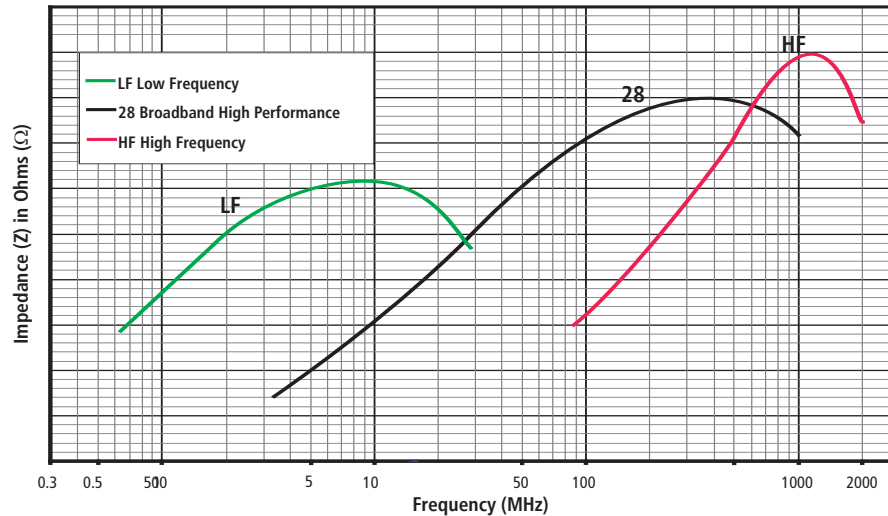

DESIGN & SELECTION “RULES OF THUMB”

SELECT THE APPROPRIATE FERRITE MATERIAL

For the EMI frequency range to be attenuated, refer to cable core material impedance vs. frequency chart above.

FERRITE MATERIAL COMPOSITION AFFECTS CORE PERFORMANCE MOST

High-performance material is best. Cheap, low-performance materials require the use of larger, heavier cores.

SHAPE (DESIGN) AND MASS OF THE FERRITE CORE SIGNIFICANTLY AFFECT IMPEDANCE

DON'T OVER SIZE

Use high-performance ferrite material and select the smallest core that will do the job. High-performance material allows the use of smaller, lighter and lower cost cores.

SELECT A FERRITE CORE THAT FITS OVER THE CABLE'S OUTSIDE DIMENSIONS

Core should slide easily over the cable during installation.

WHEN POSSIBLE, INSTALL A CABLE CORE OVER WIRES IN A COMMON MODE CONFIGURATION

(Out and back lines inside the same ferrite cable core). A differential cable pair inside the same core will make the ferrite core a common mode choke that is not susceptible to saturation from very high currents.

INSTALL THE FERRITE CORE NEAR THE NOISE SOURCE

ADDITIONAL TURNS THROUGH A CORE WILL PROVIDE MULTIPLE AMOUNTS OF PEAK IMPEDANCE

Example: Two wire turns provide four times the impedance of one turn (pass through) the ferrite core. Also, with each added turn, the peak impedance shifts to a slightly lower frequency.

TWO-PIECE SPLIT CORES ARE AVAILABLE

One-piece cylindrical or flat ribbon ferrite core shapes are usually preferable, but split cores can be used in applications where cores cannot slide over cable ends and connectors. Some split cores are available with snap-on plastic cases or metal clips.

SIDE-BY-SIDE IMPEDANCE TESTING OF FERRITE CORES IS THE BEST WAY TO COMPARE PERFORMANCE OF DIFFERENT CORES

Ferrite core impedance measurement equipment and test methods are not standardized in the industry. Every ferrite company has their own test methods. Catalog (web site) impedance data cannot be accurately compared.

Optimized, high-performance, low-cost custom part designs are available.

HIGH FREQUENCY FERRITE CYLINDRICAL EMI CORES



300 MHZ TO 2 GHZ OPTIMIZED

Cylindrical Solid Ferrite Cores for Round Cables & Wiring Harnesses

PART NUMBERING SYSTEM EXAMPLE

HF	B	075024	-0	0	0
Material Type	Product Code	Part Size Code (mm)	Selected Dimension Code (Usually Length)	Additional Part Description	Additional Part Description or Coating Code

Part Number	DIMENSIONS mm (inches)			Net Impedance (Z) in Ohms (Ω)			
	A	B	C	@ 300 MHz	@ 500 MHz	@ 800 MHz	@ 1 GHz
HFB075024-000	7.52 (0.296)	2.39 (0.094)	10.00 (0.394)	124	136	138	138
HFB075025-000	7.52 (0.296)	2.39 (0.094)	20.00 (0.787)	157	292	442	436
HFB095051-100	9.52 (0.375)	5.08 (0.200)	10.00 (0.394)	64	74	89	85
HFB095051-200	9.52 (0.375)	5.08 (0.200)	19.00 (0.748)	120	135	151	147
HFB123049-000	12.32 (0.485)	4.88 (0.192)	5.00 (0.197)	50	56	63	61
HFB123049-100	12.32 (0.485)	4.88 (0.192)	10.00 (0.394)	97	110	120	115
HFB123049-300	12.32 (0.485)	4.88 (0.192)	25.40 (1.000)	258	287	300	246
HFB143064-000	14.27 (0.562)	6.35 (0.250)	5.00 (0.197)	43	50	58	60
HFB143064-100	14.27 (0.562)	6.35 (0.250)	10.00 (0.394)	85	100	113	115
HFB143064-300	14.27 (0.562)	6.35 (0.250)	28.58 (1.125)	270	315	270	200
HFB150070-200	14.99 (0.590)	6.99 (0.275)	28.58 (1.125)	242	287	270	204
HFB152034-000	15.24 (0.600)	3.38 (0.133)	10.00 (0.394)	165	190	189	185
HFB157070-000	15.65 (0.616)	6.99 (0.275)	20.00 (0.787)	170	200	220	205
HFB159079-100	15.88 (0.625)	7.87 (0.310)	28.58 (1.125)	235	290	302	260
HFB160093-200	16.00 (0.630)	9.25 (0.364)	19.00 (0.748)	120	145	155	170
HFB160093-300	16.00 (0.630)	9.25 (0.364)	27.99 (1.102)	170	198	232	220
HFB170070-000	16.99 (0.669)	7.01 (0.276)	10.00 (0.394)	97	115	127	140
HFB170070-100	16.99 (0.669)	7.01 (0.276)	20.00 (0.787)	185	215	239	220
HFB187102-100	18.67 (0.735)	10.16 (0.400)	30.00 (1.181)	205	250	270	210
HFB259128-100	25.91 (1.020)	12.83 (0.505)	28.58 (1.125)	175	210	254	250

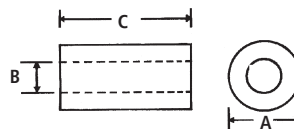

All impedance values for high frequency cores are NET; NET impedance is impedance of the ferrite core only. All impedance contribution from the test wire and fixtures has been removed.



HIGH FREQUENCY FERRITE SPLIT / SNAP-ON, CORES IN PLASTIC CASES

300 MHZ TO 2 GHZ OPTIMIZED

Split, Snap-on Ferrite Cores in Plastic Cases

For retrofit and post-assembly operations, a selection of high frequency EMI “split” cores are offered. Similar in performance to one-piece cylindrical core designs, these split ferrite cores provide excellent common and differential mode high frequency EMI suppression on round cable and wire assemblies. Black plastic snap-on cases provide secure closure of the split cores onto the cable or wire bundle.

PART NUMBERING SYSTEM EXAMPLE

HF	A	100035	-0	A	2
Material Type	Product Code	Part Size Code (mm)	Selected Dimension Code (Usually Length)	Additional Part Description	Plastic Case Color Code

All impedance values for high frequency cores are NET; NET impedance is impedance of the ferrite core only. All impedance contribution from the test wire and fixtures has been removed.

Part Number	Fig #	PLASTIC CASE DIMENSIONS mm (inches)				Maximum Cable Diameter mm (inches)	Net Impedance (Z) in Ohms (Ω)				Laird Technologies' Solid Cylindrical Core Similar Parts (for reference)
		A	B	C	D		@ 300 MHz	@ 500 MHz	@ 800 MHz	@ 1 GHz	
HFA100035-0A2	1	13.00 (0.511)	3.50 (0.138)	25.20 (0.992)	11.50 (0.453)	3.51 (0.138)	172	192	190	150	HFB100035-000
HFA100049-0A2	1	13.72 (0.540)	5.44 (0.214)	30.56 (1.203)	13.72 (0.540)	4.88 (0.192)	133	152	168	162	HFB095051-200
HFA150066-0A2	2	18.15 (0.715)	7.05 (0.278)	32.50 (1.280)	18.90 (0.744)	6.60 (0.260)	274	350	340	256	HFB143064-300
HFA150068-0A2	1	21.00 (0.827)	6.80 (0.268)	41.70 (1.642)	21.00 (0.827)	6.76 (0.266)	275	340	281	200	HFB150070-200
HFA163090-0A2	1	19.10 (0.752)	9.09 (0.358)	40.36 (1.589)	20.80 (0.819)	9.01 (0.355)	210	260	262	200	HFB160093-300
HFA187102-0A2	2	22.88 (0.877)	10.00 (0.394)	32.77 (1.290)	21.84 (0.860)	10.16 (0.400)	220	290	281	210	HFB187102-100
HFA259131-0A2	2	29.00 (1.142)	13.00 (0.512)	32.50 (1.280)	29.62 (1.166)	13.06 (0.514)	250	315	272	200	HFB259128-100

0A2 part number suffix designates black plastic case. Additional colors may be available, please inquire with Laird Technologies' customer service.

Figure 1

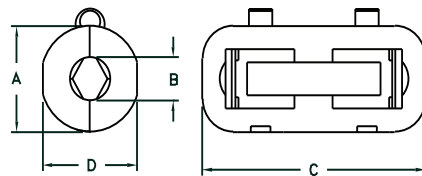
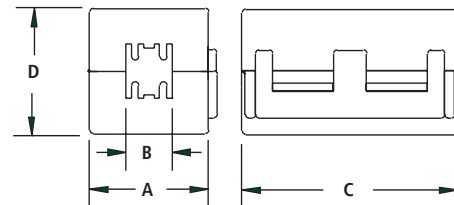

Figure 2



Please visit lairdtech.com for the most up to date information. Custom parts are available.

BROADBAND EMI FERRITE CYLINDRICAL CORES



FOR ROUND CABLES & WIRING HARNESES

PART NUMBERING SYSTEM EXAMPLE

28	B	0141	-0	0	0
Material Type	Product Code	Part Size Code	Selected Dimension Code (Usually Length)	Additional Part Description	Additional Part Description or Coating Code

Part Number	DIMENSIONS mm (inches)			Net Impedance (Z) in Ohms (Ω)		
	A	B	C	@ 25 MHz	@ 100 MHz	@ 300 MHz
28B0141-000	3.50 (0.138)	1.50 (0.059)	3.25 (0.128)	30	79	192
28B0157-100	4.00 (0.157)	2.00 (0.079)	10.00 (0.394)	67	121	236
28B0250-100	6.35 (0.250)	3.18 (0.125)	15.88 (0.625)	90	182	300
28B0250-700	6.35 (0.250)	3.18 (0.125)	10.00 (0.394)	64	135	255
28B0268-000	6.78 (0.267)	3.99 (0.157)	14.22 (0.560)	65	138	260
28B0275-000	7.00 (0.276)	3.80 (0.150)	13.50 (0.531)	69	146	268
28B0296-000	7.52 (0.296)	2.39 (0.94)	7.54 (0.297)	75	160	270
28B0306-000	7.80 (0.307)	3.00 (0.118)	19.00 (0.748)	121	231	352
28B0315-000	8.00 (0.315)	3.17 (0.125)	4.78 (0.188)	43	100	220
28B0315-100	8.00 (0.315)	3.17 (0.125)	10.06 (0.396)	76	158	281
28B0339-000	8.60 (0.339)	3.80 (0.150)	10.00 (0.394)	68	143	264
28B0355-000	9.00 (0.354)	4.75 (0.187)	20.00 (0.787)	110	205	360
28B0375-000	9.53 (0.375)	5.08 (0.200)	10.41 (0.410)	57	125	245
28B0375-100	9.53 (0.375)	5.08 (0.200)	14.48 (0.570)	74	154	282
28B0375-300	9.53 (0.375)	5.08 (0.200)	19.05 (0.750)	100	194	310
28B0375-400	9.52 (0.375)	5.08 (0.200)	4.83 (0.190)	33	81	200
28B0384-000	9.75 (0.384)	3.80 (0.150)	10.00 (0.394)	82	159	286
28B0384-200	9.75 (0.384)	3.80 (0.150)	25.00 (0.984)	182	322	473
28B0390-200	9.91 (0.390)	6.35 (0.250)	15.00 (0.590)	57	128	248
28B0394-000	10.00 (0.394)	5.00 (0.197)	5.00 (0.197)	34	86	201
28B0395-000	10.01 (0.394)	5.97 (0.235)	6.17 (0.243)	31	83	199
28B0434-000	11.00 (0.433)	5.10 (0.201)	32.00 (1.260)	200	349	481
28B0453-000	11.50 (0.453)	4.90 (0.193)	25.00 (0.984)	148	262	378

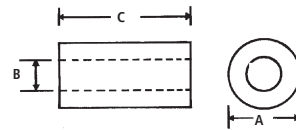

Broadband (28) round cable parts are sorted by inside diameter on pages 12 & 13 and sorted by impedance on pages 14 & 15.

Please refer to the separate Toroid Catalog from Laird Technologies for an extensive list of small ferrite inductor toroid core sizes and materials.

BROADBAND EMI FERRITE CYLINDRICAL CORES

Part Number	DIMENSIONS mm (inches)			Net Impedance (Z) in Ohms (Ω)		
	A	B	C	@ 25 MHz	@ 100 MHz	@ 300 MHz
28B0470-000	12.00 (0.472)	5.60 (0.220)	20.00 (0.787)	103	202	320
28B0472-090	12.00 (0.472)	3.60 (0.142)	20.00 (0.787)	158	272	390
28B0473-000	12.00 (0.472)	3.55 (0.140)	10.00 (0.394)	101	195	320
28B0473-200	12.00 (0.472)	3.55 (0.140)	25.00 (0.984)	240	424	558
28B0474-000	12.00 (0.472)	4.50 (0.177)	20.00 (0.787)	138	245	370
28B0485-000	12.32 (0.485)	4.88 (0.192)	25.40 (1.000)	170	320	450
28B0500-100	12.70 (0.500)	7.92 (0.312)	6.35 (0.250)	33	83	200
28B0500-300	12.70 (0.500)	7.92 (0.312)	12.70 (0.500)	54	118	230
28B0562-000	14.27 (0.562)	6.35 (0.250)	10.16 (0.400)	69	145	270
28B0562-100	14.27 (0.562)	6.35 (0.250)	13.46 (0.530)	89	184	303
28B0562-200	14.27 (0.562)	6.35 (0.250)	28.58 (1.125)	177	317	470
28B0562-300	14.27 (0.562)	6.35 (0.250)	28.32 (1.115)	150	270	420
28B0563-000	14.27 (0.562)	7.26 (0.286)	15.24 (0.600)	85	173	295
28B0563-100	14.27 (0.562)	7.26 (0.286)	20.30 (0.800)	109	217	333
28B0563-200	14.27 (0.562)	7.26 (0.286)	28.57 (1.125)	149	287	406
28B0570-000	14.48 (0.570)	8.51 (0.335)	5.51 (0.217)	32	82	200
28B0590-000	14.99 (0.590)	6.99 (0.275)	27.94 (1.100)	170	300	450
28B0591-200	15.00 (0.591)	5.90 (0.232)	35.00 (1.378)	250	450	580
28B0592-000	15.00 (0.591)	4.50 (0.177)	40.00 (1.575)	361	653	627
28B0616-000	15.65 (0.616)	6.99 (0.275)	28.58 (1.125)	170	310	450
28B0625-000	15.88 (0.625)	7.87 (0.310)	14.27 (0.563)	79	163	273
28B0625-100	15.88 (0.625)	7.87 (0.310)	28.58 (1.125)	150	280	400
28B0629-000	16.00 (0.630)	10.00 (0.394)	16.00 (0.630)	60	129	248
28B0631-000	16.00 (0.630)	9.25 (0.364)	11.99 (0.472)	60	130	250
28B0631-100	16.00 (0.630)	9.25 (0.364)	27.99 (1.102)	124	243	370
28B0672-000	17.07 (0.672)	8.76 (0.345)	25.40 (1.000)	130	245	360
28B0686-000	17.42 (0.686)	9.52 (0.375)	6.35 (0.250)	39	91	214

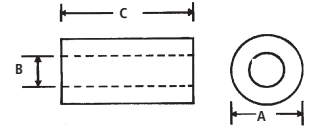

Additional wire turns
multiply impedance

BROADBAND EMI FERRITE CYLINDRICAL CORES

Part Number	DIMENSIONS mm (inches)			Net Impedance (Z) in Ohms (Ω)		
	A	B	C	@ 25 MHz	@ 100 MHz	@ 300 MHz
28B0686-100	17.42 (0.686)	9.52 (0.375)	12.70 (0.500)	66	139	265
28B0686-200	17.42 (0.686)	9.53 (0.375)	28.58 (1.125)	124	242	390
28B0734-000	18.67 (0.735)	11.18 (0.440)	28.58 (1.125)	116	229	370
28B0735-000	18.67 (0.735)	10.16 (0.400)	28.58 (1.125)	135	250	400
28B0735-300	18.67 (0.735)	10.16 (0.400)	14.27 (0.562)	73	150	270
28B0773-050*	19.64 (0.773)	11.64 (0.458)	12.70 (0.500)	69	141	273
28B0825-000	20.95 (0.825)	13.21 (0.520)	6.35 (0.250)	31	79	204
28B0870-000	22.10 (0.870)	13.72 (0.540)	6.35 (0.250)	34	85	205
28B0870-100	22.10 (0.870)	13.72 (0.540)	12.70 (0.500)	56	122	236
28B0925-000	23.50 (0.925)	12.50 (0.492)	9.50 (0.374)	48	109	221
28B0999-000	25.40 (1.000)	15.49 (0.610)	12.70 (0.500)	56	122	247
28B1000-000	25.40 (1.000)	12.70 (0.500)	12.70 (0.500)	73	151	278
28B1020-100	25.91 (1.020)	12.83 (0.505)	28.58 (1.125)	147	276	412
28B1122-100	28.50 (1.122)	13.77 (0.542)	28.58 (1.125)	160	307	440
28B1122-300	28.50 (1.122)	13.77 (0.542)	20.00 (0.787)	115	210	350
28B1142-000	29.01 (1.142)	19.00 (0.748)	7.49 (0.295)	34	85	200
28B1142-100	29.01 (1.142)	19.00 (0.748)	13.84 (0.545)	54	114	235
28B1225-000	31.12 (1.225)	19.05 (0.750)	15.93 (0.627)	68	140	270
28B1225-100	31.12 (1.225)	19.05 (0.750)	7.92 (0.312)	39	93	210
28B1225-300	31.12 (1.225)	19.05 (0.750)	10.00 (0.394)	46	110	240
28B1250-000	31.75 (1.250)	19.05 (0.750)	22.22 (0.875)	92	186	292
28B1417-200	36.00 (1.417)	23.00 (0.905)	12.70 (0.500)	52	115	230
28B1531-000*	38.86 (1.530)	12.95 (0.510)	28.58 (1.125)	109	210	347
28B1540-000	39.12 (1.540)	16.76 (0.660)	22.22 (0.875)	130	254	405
28B2000-100	50.80 (2.000)	25.40 (1.000)	28.70 (1.130)	157	305	442
28B2400-000	60.96 (2.400)	35.56 (1.400)	12.70 (0.500)	60	135	285

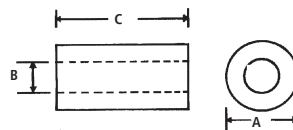

*Oval Core Part Number	DIMENSIONS mm (inches)	
	D	E
28B0773-050	13.10 (0.515)	5.10 (0.201)
28B1531-000	26.16 (1.030)	26.04 (1.025)

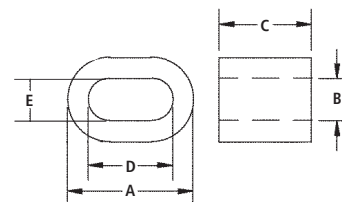

Broadband (28) round cable parts are sorted by inside diameter on pages 12 & 13 and sorted by impedance on pages 14 & 15.

Custom parts are also available



BROADBAND EMI FERRITE SPLIT / SNAP-ON CORES IN PLASTIC CASES

FOR ROUND CABLES & WIRING HARNESSSES

For retrofit and post-assembly operations, Laird Technologies offers a selection of "split" cores. Similar in performance to the one-piece core designs, these split ferrite cores provide excellent common and differential mode EMI suppression on round cable and wire assemblies. Black or white plastic snap-on cases provide secure closure of the split cores onto the cable.

PART NUMBERING SYSTEM EXAMPLE

28	A	0350	-0	B	*0 (white case) *2 (black case)	Broad Band High Performance Material is 28 High Frequency Material is HF
Material Type	Product Code	Part Size Code	Selected Dimension Code (Usually Length)	Additional Part Description	Plastic Case Color Code	

Part Number	Fig # on page 11	PLASTIC CASE DIMENSIONS mm (inches)				Maximum Cable Diameter mm (inches)	Typical Impedance (Z) in Ohms (Ω)			Laird Technologies' Solid Cylindrical Core Similar Parts (for reference)
		A	B	C	D		@ 25 MHz	@ 100 MHz	@ 300 MHz	
28A0350-0B2	1	13.00 (0.511)	3.50 (0.138)	25.20 (0.992)	11.50 (0.453)	3.50 (0.138)	100	240	400	28B0472-090
28A0392-0A*	1	13.72 (0.540)	5.44 (0.214)	30.56 (12.03)	12.72 (0.540)	4.75 (0.187)	75	170	320	28B0375-300
28A0434-0A2	4	14.71 (0.579)	5.44 (0.214)	42.88 (1.688)	14.70 (0.579)	5.05 (0.119)	111	277	449	28B0434-000
28A0592-0A2	4	18.75 (0.738)	5.04 (0.198)	53.39 (2.102)	18.75 (0.738)	4.40 (0.137)	261	572	688	28B0592-000
28A0593-0A2	4	18.75 (0.738)	6.75 (0.266)	52.91 (2.083)	18.75 (0.738)	6.50 (0.256)	186	407	575	28B0591-200
28A0640-0A*	1	19.90 (0.783)	9.80 (0.346)	41.40 (1.630)	21.65 (0.819)	8.95 (0.352)	105	240	390	28B0631-100
28A0807-0A2	4	24.82 (0.977)	10.00 (0.394)	55.91 (2.201)	24.82 (0.977)	10.00 (0.394)	160	348	514	28B0735-000
28A1507-0A2	3	15.00 (0.591)	7.00 (0.276)	18.00 (0.709)	22.00 (0.866)	7.00 (0.276)	56	123	246	28B1507-000
28A2005-0A2	3	13.00 (0.512)	5.00 (0.197)	25.50 (1.004)	11.70 (0.461)	2.50 (0.098)	88	190	330	28B0394-000
28A2024-0A*	2	29.00 (1.142)	13.00 (0.512)	32.50 (1.280)	29.62 (1.166)	12.85 (0.506)	130	280	440	28B1020-100
28A2025-0A*	2	18.15 (0.715)	7.05 (0.278)	32.50 (1.280)	18.90 (0.744)	6.45 (0.254)	130	320	510	28B0562-200
28A2026-0A2	1	21.00 (0.827)	6.80 (0.268)	41.70 (1.642)	21.00 (0.827)	6.45 (0.254)	95	270	460	28B0562-200
28A2029-0A*	2	22.28 (0.877)	10.00 (0.394)	32.77 (1.290)	21.84 (0.860)	9.95 (0.392)	95	250	420	28B0734-000
28A2307-0A2	3	16.50 (0.650)	7.00 (0.276)	30.50 (1.201)	15.25 (0.600)	7.00 (0.276)	92	183	315	28B2307-000
28A2432-0A2	3	19.20 (0.756)	8.20 (0.323)	19.90 (0.783)	23.10 (0.909)	8.05 (0.317)	62	160	300	28B0672-000
28A2736-0A2	1	19.70 (0.776)	9.00 (0.354)	35.10 (1.382)	18.00 (0.709)	8.90 (0.350)	120	220	360	28B0631-100
28A2809-0A2	3	16.00 (0.630)	9.00 (0.354)	28.00 (1.102)	7.50 (0.295)	9.00 (0.354)	120	220	360	28B2736-000
28A2738-0A2	3	19.70 (0.776)	9.00 (0.354)	35.10 (1.382)	18.00 (0.709)	8.00 (0.315)	109	233	366	28B2738-000
28A2913-0A2	3	23.50 (0.925)	13.06 (0.514)	36.25 (1.427)	22.00 (0.866)	13.00 (0.512)	86	177	305	28B2913-000
28A3039-0A2	3	24.55 (0.967)	10.20 (0.402)	13.60 (0.535)	28.50 (1.122)	10.15 (0.400)	55	130	250	28B0735-300
28A3851-0A2	1	30.00 (1.181)	13.00 (0.512)	33.70 (1.327)	30.00 (1.181)	12.85 (0.506)	150	260	410	28B1020-100
28A4155-0A2	3	28.80 (1.134)	13.60 (0.535)	15.40 (0.606)	33.20 (1.307)	13.55 (0.533)	50	120	230	28B0825-100
28A5131-0A2	5	56.64 (2.230)	19.50 (0.768)	45.00 (1.772)	56.63 (2.230)	25.40 (1.000)	187	425	533	28B2000-100

Broadband (28) round cable parts are sorted by inside diameter on pages 12 & 13 and sorted by impedance on pages 14 & 15.

*0A0 = White Plastic Snap On Case
*0A2 = Black Plastic Snap On Case

HIGH FREQUENCY

SPLIT / SNAP-ON, FERRITE CORES IN PLASTIC CASES

Part Number	Fig #	PLASTIC CASE DIMENSIONS mm (inches)				Maximum Cable Diameter mm (inches)	Net Impedance (Z) in Ohms (Ω)				Laird Technologies' Solid Cylindrical Core Similar Parts (for reference)
		A	B	C	D		@ 300 MHz	@ 500 MHz	@ 800 MHz	@ 1 GHz	
HFA100035-0A2	1	13.00 (0.511)	3.50 (0.138)	25.20 (0.992)	11.50 (0.453)	3.51 (0.138)	172	192	190	150	HFB100035-000
HFA100049-0A2	1	13.72 (0.540)	5.44 (0.214)	30.56 (1.203)	13.72 (0.540)	4.88 (0.192)	133	152	168	162	HFB095051-200
HFA150066-0A2	2	18.15 (0.715)	7.05 (0.278)	32.50 (1.280)	18.90 (0.744)	6.60 (0.260)	274	350	340	256	HFB143064-200
HFA150068-0A2	1	21.00 (0.827)	6.80 (0.268)	41.70 (1.642)	21.00 (0.827)	6.76 (0.266)	275	340	281	200	HFB150070-200
HFA163090-0A2	1	19.10 (0.752)	9.09 (0.358)	40.36 (1.589)	20.80 (0.819)	9.01 (0.355)	210	260	262	200	HFB160093-300
HFA187102-0A2	2	22.28 (0.877)	10.00 (0.394)	32.77 (1.290)	21.84 (0.860)	10.16 (0.400)	220	290	281	210	HFB187102-100
HFA259131-0A2	2	29.00 (1.142)	13.00 (0.512)	32.50 (1.280)	29.62 (1.166)	13.06 (0.514)	250	315	272	200	HFB259128-100

All impedance values for high frequency cores are NET; NET impedance is impedance of the ferrite core only. All impedance contribution from the test wire and fixtures has been removed.

-0A2 = Black Plastic Snap-On Case
 - Other parts may be available.
 Please contact Laird Technologies.

PLASTIC CASE SPLIT / SNAP-ON PART DIAGRAMS

Figure 1

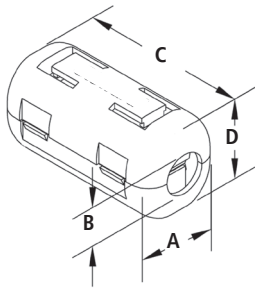

Figure 2

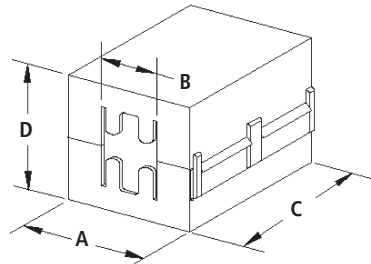

Figure 3

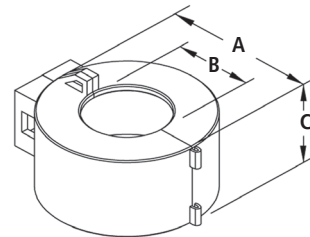

Figure 4

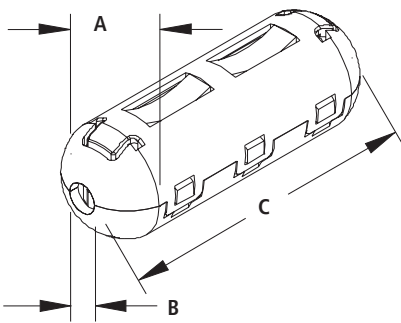
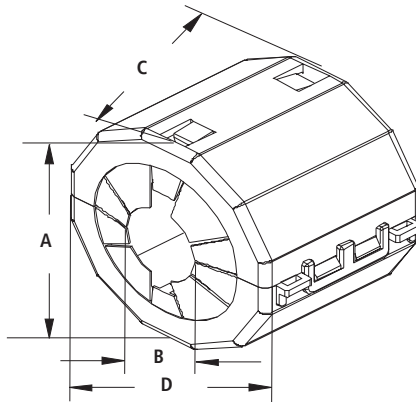

Figure 5



REFERENCE CHART

SORTED BY INSIDE DIAMETER (B)

BROADBAND 28 MATERIAL PARTS ONLY

ONE-PIECE (28B) & SPLIT / SNAP-ON (28A) CORES FOR ROUND CABLES & WIRES

PART NUMBER Sorted by I.D.	DIMENSIONS in mm I.D.			
	A	B	C	D
28B0141-000	3.5	1.50	3.25	-
28B0157-100	4.00	2.00	10.00	-
28B0296-000	7.52	2.39	7.54	-
28B0306-000	7.80	3.00	19.00	-
28B0315-000	8.00	3.17	4.78	-
28B0315-100	8.00	3.17	10.06	-
28B0250-100	6.35	3.18	15.88	-
28B0250-700	6.35	3.18	10.00	-
28A0350-0B2	13.00	3.50	25.20	11.50
28B0473-000	12.00	3.55	10.00	-
28B0473-200	12.00	3.55	25.00	-
28B0472-090	12.00	3.60	20.00	-
28B0339-000	8.60	3.80	10.00	-
28B0384-000	9.75	3.80	10.00	-
28B0275-000	7.00	3.80	13.50	-
28B0384-200	9.75	3.80	25.00	-
28B0268-000	6.78	3.99	14.22	-
28B0474-000	12.00	4.50	20.00	-
28B0592-000	15.00	4.50	40.00	-
28B0355-000	9.00	4.75	20.00	-
28B0485-000	12.32	4.88	25.40	-
28B0453-000	11.50	4.90	25.00	-
28A2005-0A2	13.00	5.00	25.50	11.70
28B0394-000	10.00	5.00	5.00	-
28A0592-0A2	18.75	5.04	53.39	-
28B0375-400	9.52	5.08	4.83	-
28B0375-000	9.53	5.08	10.41	-
28B0375-100	9.53	5.08	14.48	-

PART NUMBER Sorted by I.D.	DIMENSIONS in mm I.D.			
	A	B	C	D
28B0375-300	9.53	5.08	19.05	-
28B0434-000	11.00	5.10	32.00	-
28A0434-0A2	14.70	5.25	43.00	14.70
28A0392-0A*	13.72	5.44	30.56	12.30
28B0470-000	12.00	5.60	20.00	-
28B0591-200	15.00	5.90	35.00	-
28B0395-000	10.01	5.97	6.17	-
28B0562-000	14.27	6.35	10.16	-
28B0562-100	14.27	6.35	13.46	-
28B0390-200	9.91	6.35	15.00	-
28B0562-300	14.27	6.35	28.32	-
28B0562-200	14.27	6.35	28.58	-
28A0593-0A2	18.75	6.75	52.90	-
28A2026-0A2	21.00	6.80	41.70	21.00
28B0590-000	14.99	6.99	27.94	-
28B0616-000	15.65	6.99	28.58	-
28A1507-0A2	15.00	7.00	18.00	22.00
28A2307-0A2	16.50	7.00	30.50	15.25
28A2025-0A*	18.15	7.05	32.50	18.90
28B0563-000	14.27	7.26	15.24	-
28B0563-100	14.27	7.26	20.30	-
28B0563-200	14.27	7.26	28.57	-
28B0625-000	15.88	7.87	14.27	-
28B0625-100	15.88	7.87	28.58	-
28B0500-100	12.70	7.92	6.35	-
28B0500-300	12.70	7.92	12.70	-
28A2432-0A2	19.20	8.20	19.90	-
28B0570-000	14.48	8.51	5.51	-

Refer to pages 7, 8, 9 & 10 for more broadband data.

All chart data can be sorted on lairdtech.com.

REFERENCE CHART

SORTED BY INSIDE DIAMETER (B)

BROADBAND 28 MATERIAL PARTS ONLY

ONE-PIECE (28B) & SPLIT / SNAP-ON (28A) CORES FOR ROUND CABLES & WIRES

PART NUMBER Sorted by I.D.	DIMENSIONS in mm I.D.			
	A	B	C	D
28B0672-000	17.07	8.76	25.40	-
28A0640-0A*	19.90	8.80	41.40	21.65
28A2736-0A2	19.70	9.00	35.10	18.00
28A2809-0A2	16.00	9.00	28.00	7.50
28B0631-000	16.00	9.25	11.99	-
28B0631-100	16.00	9.25	27.99	-
28B0686-000	17.42	9.52	6.35	-
28B0686-100	17.42	9.52	12.70	-
28B0686-200	17.42	9.53	28.58	-
28A2029-0A*	22.28	10.00	32.77	21.84
28B0629-000	16.00	10.00	16.00	-
28B0735-300	18.67	10.16	14.27	-
28B0735-000	18.67	10.16	28.58	-
28A3039-0A2	24.55	10.20	13.60	28.50
28B0734-000	18.67	11.18	28.58	-
28B0773-050	19.64	11.64	12.70	13.10
28B0925-000	23.50	12.50	9.50	-
28B1000-000	25.40	12.70	12.70	-
28B1020-100	25.91	12.83	28.58	-
28B1531-000	38.86	12.95	28.58	26.16
28A2024-0A*	29.00	13.00	32.50	29.62
28A3851-0A2	30.00	13.00	33.70	30.00
28A2913-0A2	23.50	13.06	36.25	22.00
28B0825-000	20.95	13.21	6.35	-
28A4155-0A2	28.80	13.60	15.40	33.20
28B0870-000	22.10	13.72	6.35	-
28B0870-100	22.10	13.72	12.70	-
28B1122-300	28.50	13.77	20.00	-

PART NUMBER Sorted by I.D.	DIMENSIONS in mm I.D.			
	A	B	C	D
28B1122-100	28.50	13.77	28.58	-
28B0999-000	25.40	15.49	12.70	-
28B1540-000	39.12	16.76	22.22	-
28B1142-000	29.01	19.00	7.49	-
28B1142-100	29.01	19.00	13.84	-
28B1225-100	31.12	19.05	7.92	-
28B1225-300	31.12	19.05	10.00	-
28B1225-000	31.12	19.05	15.93	-
28B1250-000	31.75	19.05	22.22	-
28A5776-0A2	29.20	19.30	42.00	29.40
28A5131-0A2	56.64	19.50	45.00	56.63
28B1417-200	36.00	23.00	12.70	-
28B2000-100	50.80	25.40	28.70	-
28B2400-000	60.96	35.56	12.70	-

Refer to pages 7, 8, 9 & 10 for more broadband data.

All chart data can be sorted on lairdtech.com.

REFERENCE CHART

SORTED BY IMPEDANCE @ 100 MHz

BROADBAND 28 MATERIAL PARTS ONLY

ONE-PIECE (28B) & SPLIT / SNAP-ON (28A) CORES FOR ROUND CABLES & WIRES

PART NUMBER Sorted by Impedance	Typical Impedance (Z) in Ohms (Ω)		
	@ 25 MHz	@ 100 MHz	@ 300 MHz
28B0141-000	30	79	192
28B0825-000	31	79	204
28B0375-400	33	81	200
28B0570-000	32	82	200
28B0395-000	31	83	199
28B0500-100	33	83	200
28B1142-000	34	85	200
28B0870-000	34	85	205
28B0394-000	34	86	201
28B0686-000	39	91	214
28B1225-100	39	93	210
28B0315-000	43	100	220
28B0925-000	48	109	221
28B1225-300	46	110	240
28B1142-100	54	114	235
28B1417-200	52	115	230
28B0500-300	54	118	230
28A4155-0A2	50	120	230
28B0157-100	67	121	236
28B0870-100	56	122	236
28B0999-000	56	122	247
28A1507-0A2	56	123	246
28B0375-000	57	125	245
28B0390-200	57	128	248
28B0629-000	60	129	248
28A3039-0A2	55	130	250
28B0631-000	60	130	250

PART NUMBER Sorted by Impedance	Typical Impedance (Z) in Ohms (Ω)		
	@ 25 MHz	@ 100 MHz	@ 300 MHz
28B0250-700	64	135	255
28B2400-000	60	135	285
28B0268-000	65	138	260
28B0686-100	66	139	265
28B1225-000	68	140	270
28B0773-050	69	141	273
28B0339-000	68	143	264
28B0562-000	69	145	270
28B0275-000	69	146	268
28B0735-300	73	150	270
28B1000-000	73	151	278
28B0375-100	74	154	282
28B0315-100	76	158	281
28B0384-000	82	159	286
28B0296-000	75	160	270
28A2432-0A2	62	160	300
28B0625-000	79	163	273
28A0392-0A*	75	170	320
28B0563-000	85	173	295
28A2913-0A2	86	177	305
28B0250-100	90	182	300
28A2307-0A2	92	183	315
28B0562-100	89	184	303
28B1250-000	92	186	292
28A2005-0A2	88	190	330
28B0375-300	100	194	310
28B0473-000	101	195	320

Refer to pages 7, 8, 9 & 10 for more broadband data.

Custom parts are also available

REFERENCE CHART

SORTED BY IMPEDANCE @ 100 MHz

BROADBAND 28 MATERIAL PARTS ONLY

ONE-PIECE (28B) & SPLIT / SNAP-ON (28A) CORES FOR ROUND CABLES & WIRES

PART NUMBER Sorted by Impedance	Typical Impedance (Z) in Ohms (Ω)		
	@ 25 MHz	@ 100 MHz	@ 300 MHz
28B0470-000	103	202	320
28B0355-000	110	205	360
28B1531-000	109	210	347
28B1122-300	115	210	350
28A5776-0A2	115	240	360
28B0563-100	109	217	333
28A2736-0A2	120	220	360
28A2809-0A2	120	220	360
28B0734-000	116	229	370
28B0306-000	121	231	352
28A2738-0A2	109	233	366
28A0640-0A*	105	240	390
28A0350-0B2	100	240	400
28B0686-200	124	242	390
28B0631-100	124	243	370
28B0474-000	132	245	370
28B0672-000	130	245	360
28B0735-000	135	250	400
28A2029-0A*	95	250	420
28B1540-000	130	254	405
28A3851-0A2	150	260	410
28B0453-000	148	262	378
28B0562-300	150	270	420
28A2026-0A2	95	270	460
28B0472-090	158	272	390
28B1020-100	147	276	412
28A0434-0A2	111	277	449
28B0625-100	150	280	400

PART NUMBER Sorted by Impedance	Typical Impedance (Z) in Ohms (Ω)		
	@ 25 MHz	@ 100 MHz	@ 300 MHz
28A2024-0A*	130	280	440
28B0563-200	149	287	406
28B0590-000	170	300	450
28B2000-100	157	305	442
28B1122-100	160	307	440
28B0616-000	170	310	450
28B0562-200	177	317	470
28B0485-000	170	320	450
28A2025-0A*	130	320	510
28B0384-200	182	322	473
28B0434-000	200	349	481
28A0593-0A2	186	407	575
28B0473-200	270	424	558
28A5131-0A2	187	425	533
28B0591-200	250	250	580
28A0592-0A2	261	275	688
28B0592-000	361	653	627

Refer to pages 7, 8, 9 & 10 for more broadband data.

Custom parts are also available

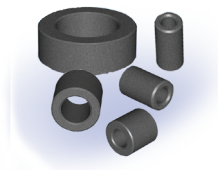

LOW FREQUENCY FERRITE EMI CORES

FOR ROUND CABLES & WIRING HARNESSSES 300 KHZ TO 30 MHZ OPTIMIZED

PART NUMBERING SYSTEM EXAMPLE

LF	B	090050	-0	0	0
Material Type	Product Code	Part Size Code	Selected Dimension Code (Usually Length)	Additional Part Description	Additional Part Description or Coating Code

PART NUMBER	DIMENSIONS mm (inches)			Typical Impedance (Z) in Ohms (Ω)								
				Ω @ 500 KHz			Ω @ 1 MHz			Ω @ 5 MHz		
	# of Wire Turns			# of Wire Turns			# of Wire Turns					
	A	B	C	1	2	5	1	2	5	1	2	5
LFB090050-000	9.00 (0.354)	5.00 (0.197)	7.00 (0.275)	12	28	370	21	90	558	36	140	867
LFB095051-000	9.50 (0.374)	5.10 (0.201)	19.05 (0.750)	36	150	846	63	240	1464	86	340	2514
LFB127079-000	12.70 (0.500)	7.92 (0.312)	7.00 (0.276)	9	45	301	16	70	436	25	102	593
LFB143064-000	14.27 (0.562)	6.35 (0.250)	28.58 (1.125)	70	290	1757	122	490	2842	120	480	2646
LFB143064-100	14.27 (0.562)	6.35 (0.250)	13.46 (0.530)	33	145	626	57	220	1169	53	215	1552
LFB159079-000	15.88 (0.625)	7.87 (0.310)	28.58 (1.125)	61	250	1605	105	410	2615	100	390	2305
LFB174095-000	17.40 (0.685)	9.50 (0.374)	28.58 (1.125)	52	200	1290	91	350	2184	85	340	2044
LFB180100-000	18.10 (0.713)	10.00 (0.394)	10.00 (0.394)	18	75	493	31	138	809	29	115	722
LFB187102-000	18.67 (0.735)	10.16 (0.400)	28.58 (1.125)	53	200	1182	91	350	1969	84	330	1863
LFB220140-000	22.10 (0.870)	14.00 (0.551)	12.70 (0.500)	18	72	469	30	120	818	28	110	699
LFB250150-000	25.00 (0.984)	15.00 (0.591)	13.00 (0.512)	16	70	562	34	136	850	26	80	624
LFB259128-000	25.91 (1.020)	12.83 (0.505)	28.58 (1.125)	61	220	1446	106	420	2647	62	240	1487
LFB290190-000	28.98 (1.141)	19.05 (0.750)	15.21 (0.599)	19	90	533	34	155	963	22	70	513
LFB310190-000	31.00 (1.220)	19.00 (0.748)	13.00 (0.512)	19	80	523	33	143	845	22	88	554
LFB360230-300	36.00 (1.417)	23.00 (0.905)	15.00 (0.591)	24	96	614	27	110	653	19	75	438

All impedance values for high frequency cores are NET; NET impedance is impedance of the ferrite core only. All impedance contribution from the test wire and fixtures has been removed.

This catalog lists a limited sample of available parts. Custom parts are also available..

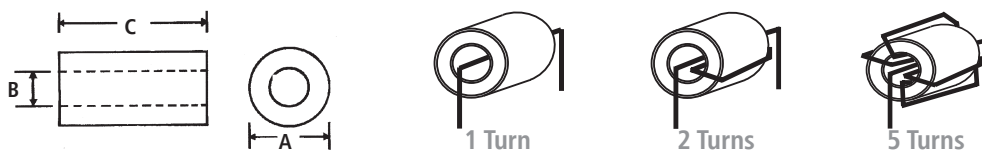

BROADBAND FERRITE EMI CORES FOR RIBBON & FLEX CABLES

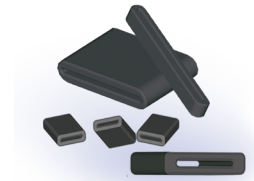

PART NUMBERING SYSTEM EXAMPLE

28	R	0315	-2	0	0
Material Type	Product Code	Part Size Code	Selected Dimension Code (Usually Length)	Additional Part Description	Additional Part Description or Coating Code

PART NUMBER	Fig # on page 20	DIMENSIONS mm (inches)					Typical Impedance (Z) in Ohms (Ω)		
		A	B	C*	D	E	@ 25 MHz	@ 100 MHz	@ 300 MHz
28R0315-200	2	8.00 (0.315)	6.00 (0.236)	12.00 (0.472)	2.70 (0.106)	0.70 (0.028)	48	102	250
28R0354-100	3	9.00 (0.354)	7.00 (0.276)	14.00 (0.551)	2.70 (0.106)	0.70 (0.028)	50	125	269
28R0386-000	3	9.80 (0.386)	7.30 (0.287)	8.00 (0.315)	3.30 (0.130)	0.80 (0.0315)	36	96	224
28R0394-000	2	10.00 (0.394)	7.00 (0.276)	25.00 (0.984)	5.00 (0.197)	2.00 (0.079)	92	196	294
28R0453-200	2	11.50 (0.453)	8.00 (0.315)	12.00 (0.472)	3.00 (0.118)	0.70 (0.028)	43	104	260
28R0453-300	2	11.50 (0.453)	8.00 (0.315)	20.00 (0.787)	3.00 (0.118)	0.70 (0.028)	65	153	335
28R0454-100	3	11.50 (0.453)	9.50 (0.374)	14.00 (0.551)	2.70 (0.106)	0.70 (0.028)	45	121	269
28R0480-000	2	12.20 (0.480)	8.00 (0.315)	18.00 (0.709)	5.50 (0.217)	1.00 (0.039)	100	190	320
28R0480-100	2	12.20 (0.480)	8.00 (0.315)	12.00 (0.472)	5.50 (0.217)	1.00 (0.039)	68	150	290
28R0492-100	2	12.50 (0.492)	8.30 (0.327)	12.00 (0.472)	5.50 (0.217)	1.00 (0.039)	68	150	290
28R0539-000	2	13.70 (0.539)	9.20 (0.362)	18.00 (0.709)	5.30 (0.209)	0.80 (0.0315)	94	190	345
28R0546-000	2	13.90 (0.547)	9.40 (0.370)	18.00 (0.709)	5.30 (0.209)	0.80 (0.0315)	91	193	419
28R0551-100	3	14.00 (0.551)	11.00 (0.433)	20.00 (0.787)	3.70 (0.146)	0.70 (0.028)	71	176	352
28R0592-010	2	15.01 (0.591)	10.00 (0.394)	22.86 (0.900)	7.49 (0.295)	1.50 (0.059)	121	227	370
28R0610-000	3	15.50 (0.610)	13.50 (0.531)	10.00 (0.394)	3.40 (0.134)	1.40 (0.055)	29	80	216
28R0614-100	2	15.60 (0.614)	13.60 (0.535)	12.00 (0.472)	2.80 (0.110)	0.70 (0.028)	36	98	245
28R0614-300	2	15.60 (0.614)	13.60 (0.535)	18.00 (0.709)	2.80 (0.110)	0.70 (0.028)	45	125	280
28R0669-000	2	17.00 (0.669)	13.00 (0.512)	12.00 (0.472)	3.50 (0.138)	0.75 (0.030)	41	110	270
28R0756-000	3	19.20 (0.756)	15.00 (0.591)	10.00 (0.394)	5.35 (0.211)	1.15 (0.045)	40	107	258

Custom parts with double sided mounting tape are available.

*Broadband (28) ribbon and flex cable cores are sorted by slot width on pages 23 & 24 and sorted by impedance on pages 25 & 26.

BROADBAND FERRITE EMI CORES FOR RIBBON & FLEX CABLES

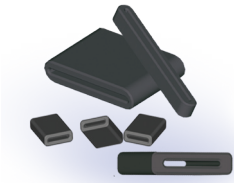

PART NUMBERING SYSTEM EXAMPLE

28	R	0315	-2	0	0
Material Type	Product Code	Part Size Code	Selected Dimension Code (Usually Length)	Additional Part Description	Additional Part Description or Coating Code

PART NUMBER	Fig # on page 20	DIMENSIONS mm (inches)					Typical Impedance (Z) in Ohms (Ω)		
		A	B	C*	D	E	@ 25 MHz	@ 100 MHz	@ 300 MHz
28R0756-200	3	19.20 (0.756)	15.00 (0.591)	16.00 (0.630)	5.35 (0.211)	1.15 (0.045)	57	140	308
28R0825-000	3	20.95 (0.825)	14.00 (0.551)	19.05 (0.750)	7.75 (0.305)	0.80 (0.031)	96	190	363
28R0852-000	3	21.65 (0.852)	17.50 (0.689)	10.00 (0.394)	5.15 (0.203)	1.00 (0.039)	41	112	268
28R0880-000	2	22.35 (0.880)	14.00 (0.551)	19.05 (0.750)	7.75 (0.305)	1.50 (0.059)	93	187	356
28R0898-100	2	22.80 (0.898)	18.70 (0.736)	12.00 (0.472)	2.80 (0.110)	0.70 (0.028)	38	110	266
28R0898-200	2	22.80 (0.898)	18.70 (0.736)	16.00 (0.630)	2.80 (0.110)	0.70 (0.028)	43	127	280
28R0906-000	3	23.00 (0.906)	20.00 (0.787)	12.00 (0.472)	3.00 (0.118)	0.70 (0.028)	40	115	263
28R0945-000	3	24.00 (0.945)	19.00 (0.748)	10.00 (0.394)	6.25 (0.246)	1.25 (0.049)	43	112	269
28R0983-000	3	25.00 (0.984)	21.00 (0.827)	15.00 (0.590)	3.00 (0.118)	0.80 (0.031)	43	123	276
28R0984-000	3	25.00 (0.984)	18.00 (0.709)	24.00 (0.945)	7.70 (0.303)	0.90 (0.035)	100	220	430
28R0984-200	3	25.00 (0.984)	18.00 (0.709)	16.00 (0.630)	7.70 (0.303)	0.90 (0.035)	70	170	370
28R1022-000	3	26.00 (1.022)	22.00 (0.866)	9.00 (0.354)	5.00 (0.197)	1.20 (0.047)	32	91	227
28R1024-000	2	26.00 (1.024)	20.50 (0.807)	10.00 (0.394)	6.00 (0.236)	0.80 (0.031)	48	128	299
28R1025-000	3	26.00 (1.024)	21.40 (0.8425)	10.00 (0.394)	5.00 (0.197)	0.75 (0.030)	37	97	242
28R1101-000	1	27.97 (1.101)	22.94 (0.903)	14.66 (0.577)	7.75 (0.305)	1.50 (0.059)	55	140	300
28R1102-000	2	28.00 (1.102)	23.00 (0.906)	15.00 (0.591)	5.80 (0.228)	0.80 (0.031)	61	154	340
28R1102-100	2	28.00 (1.102)	23.00 (0.906)	20.00 (0.787)	5.80 (0.228)	0.80 (0.031)	75	192	380
28R1103-000	2	28.00 (1.102)	23.00 (0.906)	27.00 (1.063)	6.10 (0.240)	1.10 (0.043)	95	230	480
28R1127-000	3	28.58 (1.125)	23.50 (0.925)	31.00 (1.220)	7.70 (0.303)	1.70 (0.067)	100	220	430

BROADBAND FERRITE EMI CORES FOR RIBBON & FLEX CABLES

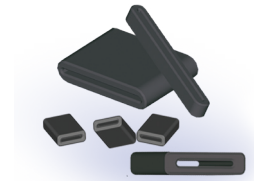

PART NUMBERING SYSTEM EXAMPLE

28	R	0315	-2	0	0
Material Type	Product Code	Part Size Code	Selected Dimension Code (Usually Length)	Additional Part Description	Additional Part Description or Coating Code

PART NUMBER	Fig # on page 20	DIMENSIONS mm (inches)					Typical Impedance (Z) in Ohms (Ω)		
		A	B	C*	D	E	@ 25 MHz	@ 100 MHz	@ 300 MHz
28R1127-200	3	28.58 (1.125)	23.50 (0.925)	24.89 (0.980)	7.70 (0.303)	1.70 (0.067)	85	191	410
28R1127-400	3	28.58 (1.125)	23.50 (0.925)	17.00 (0.669)	7.70 (0.303)	1.70 (0.067)	60	150	330
28R1127-500	3	28.58 (1.125)	23.50 (0.925)	9.70 (0.382)	7.70 (0.303)	1.70 (0.067)	40	110	265
28R1128-100	3	28.58 (1.125)	23.50 (0.925)	26.00 (1.024)	5.88 (0.231)	0.80 (0.031)	79	204	399
28R1128-200	3	28.58 (1.125)	24.00 (0.945)	14.00 (0.551)	5.38 (0.212)	0.80 (0.031)	52	145	312
28R1141-010	3	37.00 (1.457)	27.00 (1.063)	18.25 (0.715)	8.00 (0.315)	1.50 (0.059)	67	168	380
28R1177-000	3	29.90 (1.177)	23.60 (0.929)	14.00 (0.551)	7.50 (0.295)	1.20 (0.047)	62	152	340
28R1181-000	3	30.00 (1.181)	25.00 (0.984)	30.00 (1.181)	5.80 (0.288)	0.80 (0.031)	92	227	450
28R1227-100	2	31.12 (1.225)	24.77 (0.975)	13.30 (0.525)	8.26 (0.325)	1.91 (0.075)	52	128	300
28R1236-000	2	31.40 (1.236)	23.00 (0.906)	19.00 (0.748)	7.75 (0.305)	1.50 (0.059)	78	162	370
28R1240-010	2	31.40 (1.236)	23.00 (0.906)	21.00 (0.827)	7.75 (0.305)	1.00 (0.039)	84	211	440
28R1261-100	3	32.00 (1.260)	25.10 (0.988)	35.00 (1.378)	7.75 (0.305)	0.90 (0.035)	140	350	700
28R1261-200	3	32.00 (1.260)	25.10 (0.988)	9.70 (0.382)	7.75 (0.305)	0.90 (0.035)	50	135	310
28R1262-000	2	32.00 (1.260)	26.00 (1.024)	30.00 (1.181)	7.00 (0.276)	1.00 (0.039)	110	260	520
28R1262-200	2	32.00 (1.260)	26.00 (1.024)	13.00 (0.512)	7.00 (0.276)	1.00 (0.039)	53	141	344
28R1319-000	3	33.50 (1.312)	27.00 (1.063)	12.00 (0.472)	6.50 (0.256)	1.50 (0.059)	43	117	269
28R1340-100	3	34.00 (1.340)	28.00 (1.100)	12.00 (0.472)	7.00 (0.280)	1.00 (0.039)	50	139	315
28R1340-200	3	34.00 (1.340)	28.00 (1.100)	25.00 (0.984)	7.00 (0.280)	1.00 (0.039)	86	220	449
28R1417-000	2	36.00 (1.417)	26.00 (1.024)	40.00 (1.575)	11.00 (0.433)	1.00 (0.039)	187	393	734
28R1418-000	3	36.00 (1.417)	33.00 (1.299)	10.00 (0.394)	4.00 (0.157)	1.00 (0.039)	34	104	245
28R1450-100	3	36.83 (1.450)	29.58 (1.165)	10.00 (0.394)	7.75 (0.305)	0.75 (0.030)	48	130	290

BROADBAND FERRITE EMI CORES FOR RIBBON & FLEX CABLES

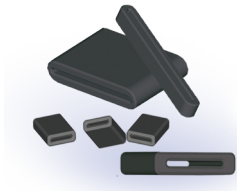

PART NUMBERING SYSTEM EXAMPLE

28	R	0315	-2	0	0
Material Type	Product Code	Part Size Code	Selected Dimension Code (Usually Length)	Additional Part Description	Additional Part Description or Coating Code

PART NUMBER	Fig # on page 20	DIMENSIONS mm (inches)					Typical Impedance (Z) in Ohms (Ω)		
		A	B	C*	D	E	@ 25 MHz	@ 100 MHz	@ 300 MHz
28R1457-400	3	37.01 (1.457)	33.00 (1.299)	13.46 (0.530)	4.50 (0.177)	0.51 (0.020)	44	140	310
28R1476-100	3	37.50 (1.476)	34.50 (1.358)	13.00 (0.512)	4.00 (0.157)	1.00 (0.039)	38	110	251
28R1496-000	2	38.00 (1.496)	30.00 (1.181)	25.00 (0.984)	9.25 (0.364)	1.25 (0.049)	91	239	479
28R1517-000	2	38.10 (1.500)	26.67 (1.050)	25.40 (1.000)	12.07 (0.475)	1.91 (0.075)	110	230	520
28R1518-000	1	38.50 (1.516)	26.80 (1.055)	25.40 (1.000)	12.09 (0.476)	1.91 (0.075)	105	235	478
28R1654-010	3	42.00 (1.654)	37.50 (1.476)	5.00 (0.197)	5.00 (0.197)	0.70 (0.028)	27	84	200
28R1775-000	2	45.08 (1.775)	34.42 (1.355)	28.58 (1.125)	12.45 (0.490)	1.52 (0.060)	115	260	530
28R1779-000	2	63.50 (2.500)	52.07 (2.050)	28.58 (1.125)	12.70 (0.500)	1.68 (0.066)	114	298	588
28R1779-100	2	63.50 (2.500)	52.07 (2.050)	12.98 (0.511)	12.70 (0.500)	1.68 (0.066)	65	170	375
28R1799-010	3	45.60 (1.795)	37.00 (1.457)	18.40 (0.724)	7.90 (0.311)	1.40 (0.055)	57	172	388
28R1800-010	2	45.72 (1.800)	35.05 (1.380)	27.94 (1.100)	12.70 (0.500)	1.52 (0.060)	110	260	555
28R1862-000	2	47.70 (1.878)	39.00 (1.535)	31.00 (1.220)	15.00 (0.590)	3.00 (0.118)	116	261	561
28R1953-000	3	49.61 (1.953)	44.00 (1.732)	12.00 (0.472)	7.62 (0.300)	1.45 (0.057)	45	127	300
28R2000-010	2	50.80 (2.000)	40.60 (1.598)	15.20 (0.598)	12.20 (0.480)	2.00 (0.079)	63	170	380
28R2000-200	2	50.80 (2.000)	40.60 (1.600)	28.00 (1.102)	12.20 (0.480)	2.00 (0.079)	103	252	545
28R2170-000	2	55.12 (2.170)	43.69 (1.720)	25.40 (1.000)	12.70 (0.500)	1.27 (0.050)	110	280	550
28R2170-100	2	55.12 (2.170)	43.69 (1.720)	12.70 (0.500)	12.70 (0.500)	1.27 (0.050)	62	170	370
28R3149-000	2	79.98 (3.149)	68.58 (2.700)	12.70 (0.500)	11.99 (0.472)	1.91 (0.075)	51	135	318

*Broadband (28) ribbon and flex cable cores are sorted by slot width on pages 23 & 24 and sorted by impedance on pages 25 & 26.

Ferrite core shape and size affect frequency response and impedance.

Please visit lairdtech.com for the most up to date information. All dimensions & impedance values can be sorted and compared on lairdtech.com. Custom parts are available.

FIGURE 1

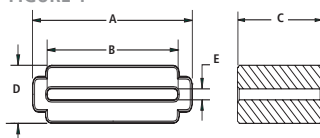

FIGURE 2

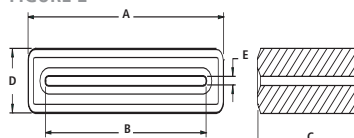
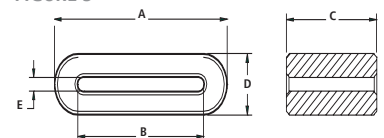
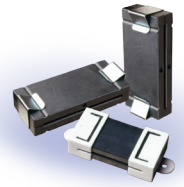

FIGURE 3



BROADBAND FERRITE EMI CORES FOR RIBBON & FLEX CABLES



Laird Technologies offers a selection of broadband “split” ribbon and flex cores for retrofit and post-assembly operations. Similar in performance to one-piece core designs, these split ferrite cores provide excellent differential and common mode EMI suppression on flat cable assemblies. Lightweight, inexpensive metal or plastic end clips and cases provide secure closure of the ferrite onto the flat cable.

PART NUMBERING SYSTEM EXAMPLE

28	S	0670	-0	0*	0	* 0 = No End Clip * M = Metal Clip * P = Plastic Clip * A = Hinged Case
Material Type	Product Code	Part Size Code	Selected Dimension Code (Usually Length)	Case or Clip Code	Additional Part Description	

PART NUMBER	Fig # on page 22	*Available End Clip Types	DIMENSIONS mm (inches)					Typical Impedance (Z) in Ohms (Ω)		
			A	B	C*	D	E	@ 25 MHz	@ 100 MHz	@ 300 MHz
28S0670-000	2	NA	17.02 (0.670)	12.50 (0.492)	14.99 (0.590)	3.40 (0.134)	0.51 (0.020)	60	150	310
28S2001-0*0	1	M, P	63.50 (2.500)	52.07 (2.050)	28.58 (1.125)	6.35 (0.250)	0.84 (0.033)	100	280	590
28S2001-2A2	3	Hinged Case	67.08 (2.641)	53.75 (2.116)	27.53 (1.084)	16.66 (0.656)	1.91 (0.075)	80	230	480
28S2011-0*0	1	M, P	76.20 (3.000)	65.28 (2.570)	28.58 (1.125)	6.35 (0.250)	0.84 (0.033)	100	280	600
28S2012-0M0	1	M	88.90 (3.500)	78.23 (3.080)	28.58 (1.125)	6.48 (0.255)	0.84 (0.033)	80	240	630
28S2022-0*0	1	M, P	45.09 (1.775)	34.42 (1.355)	28.58 (1.125)	6.35 (0.250)	0.84 (0.033)	100	250	550
28S2023-0M0	1	M	38.10 (1.500)	26.67 (1.050)	25.40 (1.000)	6.35 (0.250)	0.84 (0.033)	115	250	520
28S2827-210	1	NA	21.00 (0.827)	17.00 (0.669)	12.01 (0.473)	3.99 (0.157)	0.94 (0.037)	43	120	270

Custom parts with double sided mounting tape and hinged case are available.

*Broadband (28) ribbon and flex cable cores are sorted by slot width on pages 23 & 24 and sorted by impedance on pages 25 & 26.

** The “D” & “E” dimensions for 28S, split, two piece cores must be doubled for total assembled dimensions. “D” & “E” dimensions shown for hinged case parts are for a complete assembly.

PLASTIC CLIP DIAGRAM

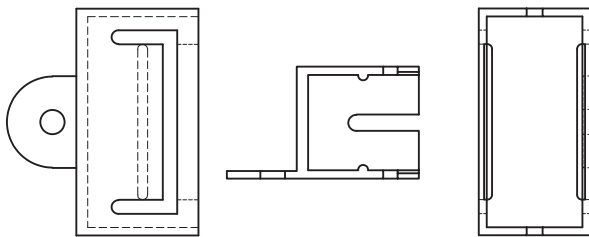

METAL CLIP DIAGRAM

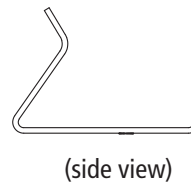

SPLIT FERRITE CORES FOR RIBBON & FLEX CABLES

PART #28S2001-2A2 SPLIT FERRITE CORE ASSEMBLY WITH HINGED BLACK PLASTIC CASE

** To determine total inside slot gap (I.D.) of an assembled split ferrite ribbon core, multiply the "E" dimension by 2. Both the "D" and "E" dimensions must be doubled for assembled core dimensions.

FIGURE 1

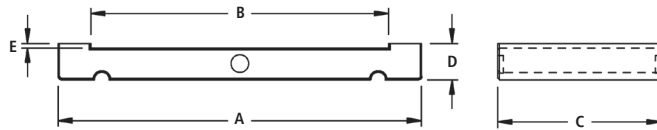

FIGURE 2

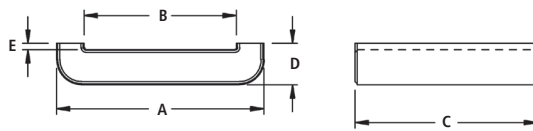
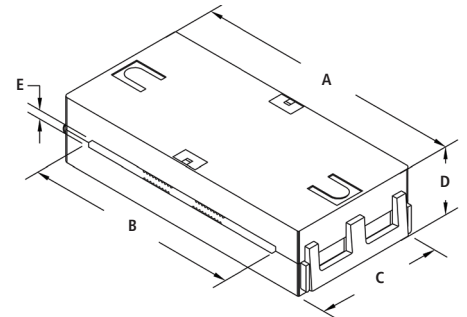
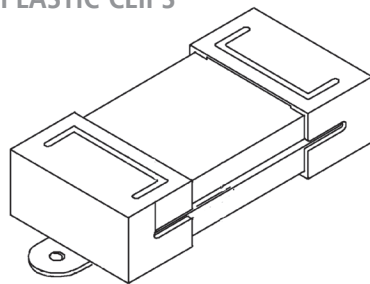

FIGURE 3



SPLIT FERRITE CORES FOR FLAT / RIBBON CABLES ARE SOLD AS SINGLE SIDES. IT IS NECESSARY TO ORDER TWO SIDES TO FORM ONE SET. [EXCEPT 28S2001-2A2 (FIGURE 3) WHICH IS SOLD ASSEMBLED]

SPLIT CORE WITH WHITE PLASTIC CLIPS



SPLIT CORE WITH METAL CLIPS

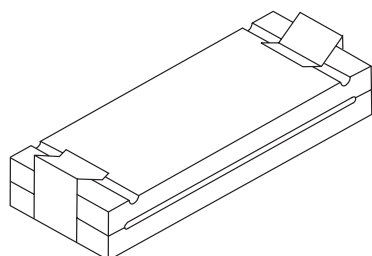

Plastic Clip Assemblies: To specify one core side and one white plastic clip together, replace the second ferrite core part number character after the dash with the letter "P" (example: 28S2022-0P0). One complete assembly of two ferrite core sides (28 material) with two plastic clips would be specified as follows: 2 of part # 28S2022-0P0. Attachment ears are standard.

Metal Clip Assemblies: To specify one core side and one metal clip together, replace the second ferrite core part number character after the dash with the letter "M" (example: 28S2022-0M0). One complete assembly of two ferrite cores (28 material) with two metal clips would be specified as follows: 2 of part # 28S2022-0M0.

Clips for Bulk Shipment: To order white plastic end clips (with attachment ears) separately in bulk, specify part number ASSE001-2. To order metal end clips separately in bulk, specify part number ASSE017-2. No standard clips are available for 28S2827-210.

QUICK REFERENCE CHART

SORTED BY SLOT WIDTH (B)

BROADBAND 28 MATERIAL PARTS ONLY

ONE-PIECE (28R) & SPLIT (28S) CORES FOR RIBBON & FLEX CABLES

PART NUMBER Sorted by Slot Width	DIMENSIONS mm (inches)				
	A	B	C	D**	E**
28R0315-200	8.00	6.00	12.00	2.70	0.70
28R0354-100	9.00	7.00	14.00	2.70	0.70
28R0394-000	10.00	7.00	25.00	5.00	2.00
28R0386-000	9.80	7.30	8.00	3.30	0.80
28R0453-200	11.50	8.00	12.00	3.00	0.70
28R0480-000	12.20	8.00	18.00	5.50	1.00
28R0480-100	12.20	8.00	12.00	5.50	1.00
28R0453-300	11.50	8.00	20.00	3.00	0.70
28R0492-100	12.50	8.30	12.00	5.50	1.00
28R0539-000	13.70	9.20	18.00	5.30	0.80
28R0546-000	13.90	9.40	18.00	5.30	0.80
28R0454-100	11.50	9.50	14.00	2.70	0.70
28R0592-010	15.01	10.00	22.86	7.49	1.50
28R0551-100	14.00	11.00	20.00	3.70	0.70
28S0670-000**	17.02	12.50	14.99	3.40	0.51
28R0669-000	17.00	13.00	12.00	3.50	0.75
28R0610-000	15.50	13.50	10.00	3.40	1.40
28R0614-100	15.60	13.60	12.00	2.80	0.70
28R0614-300	15.60	13.60	18.00	2.80	0.70
28R0825-000	20.95	14.00	19.05	7.75	0.80
28R0880-000	22.35	14.00	19.05	7.75	1.50
28R0756-000	19.20	15.00	10.00	5.35	1.15
28R0756-200	19.20	15.00	16.00	5.35	1.15
28S2827-210**	21.00	17.00	12.01	3.99	0.94
28R0852-000	21.65	17.50	10.00	5.15	1.00
28R0984-200	25.00	18.00	16.00	7.70	0.90
28R0984-000	25.00	18.00	24.00	7.70	0.90
28R0898-100	22.80	18.70	12.00	2.80	0.70
28R0898-200	22.80	18.70	16.00	2.80	0.70
28R0945-000	24.00	19.00	10.00	6.25	1.25
28R0906-000	23.00	20.00	12.00	3.00	0.70

PART NUMBER Sorted by Slot Width	DIMENSIONS mm (inches)				
	A	B	C	D**	E**
28R1024-000	26.00	20.50	10.00	6.00	0.80
28R0983-000	25.00	21.00	15.00	3.00	0.80
28R1025-000	26.00	21.40	10.00	5.00	0.75
28R1101-000	27.97	22.94	14.66	7.75	1.50
28R1102-000	28.00	23.00	15.00	5.80	0.80
28R1236-000	31.40	23.00	19.00	7.75	1.50
28R1102-100	28.00	23.00	20.00	5.80	0.80
28R1240-010	31.40	23.00	21.00	7.75	1.00
28R1103-000	28.00	23.00	27.00	6.10	1.10
28R1127-500	28.58	23.50	9.70	7.70	1.70
28R1127-400	28.58	23.50	17.00	7.70	1.70
28R1127-200	28.58	23.50	24.89	7.70	1.70
28R1128-100	28.58	23.50	26.00	5.88	0.80
28R1127-000	28.58	23.50	31.00	7.70	1.70
28R1177-000	29.90	23.60	14.00	7.50	1.20
28R1128-200	28.58	24.00	14.00	5.38	0.80
28R1227-100	31.12	24.77	13.30	8.26	1.91
28R1181-000	30.00	25.00	30.00	5.80	0.80
28R1261-200	32.00	25.10	9.70	7.75	0.90
28R1261-100	32.00	25.10	35.00	7.75	0.90
28R1262-000	32.00	26.00	30.00	7.00	1.00
28R1262-200	32.00	26.00	13.00	7.00	1.00
28R1417-000	36.00	26.00	40.00	11.00	1.00
28R1517-000	38.10	26.67	25.40	12.07	1.91
28S2023-0M0**	38.10	26.67	25.40	6.35	0.84
28R1518-000	38.50	26.80	25.40	12.09	1.91
28R1141-010	37.00	27.00	18.25	8.00	1.50
28R1319-000	33.50	27.00	12.00	6.50	1.50
28R1340-100	34.00	28.00	12.00	7.00	1.00
28R1340-200	34.00	28.00	25.00	7.00	1.00
28R1450-100	36.83	29.58	10.00	7.75	0.75

** The "D" & "E" dimensions for 28S split, two-piece cores must be doubled for total assembled dimensions.

Custom parts are also available
Refer to pages 17 - 21 for more data.

QUICK REFERENCE CHART

SORTED BY SLOT WIDTH (B)

BROADBAND 28 MATERIAL PARTS ONLY
ONE-PIECE (28R) & SPLIT (28S) CORES FOR RIBBON & FLEX CABLES

PART NUMBER Sorted by Slot Width	DIMENSIONS mm (inches)				
	A	B	C	D**	E**
28R1496-000	38.00	30.00	25.00	9.25	1.25
28R1418-000	36.00	33.00	10.00	4.00	1.00
28R1457-400	37.01	33.00	13.46	4.50	0.51
28R1775-000	45.08	34.42	28.58	12.45	1.52
28S2022-0*0**	45.09	34.42	28.58	6.35	0.84
28R1476-100	37.50	34.50	13.00	4.00	1.00
28R1800-010	45.72	35.05	27.94	12.70	1.52
28R1799-010	45.60	37.00	18.40	7.90	1.40
28R1654-010	42.00	37.50	5.00	5.00	0.70
28R1862-000	47.70	39.00	31.00	15.00	3.00
28R2000-010	50.80	40.60	15.20	12.20	2.00
28R2000-200	50.80	40.60	28.00	12.20	2.00
28R2170-100	55.12	43.69	12.70	12.70	1.27
28R2170-000	55.12	43.69	25.40	12.70	1.27
28R1953-000	49.61	44.00	12.00	7.62	1.45
28R1779-100	63.50	52.07	12.98	12.70	1.68
28R1779-000	63.50	52.07	28.58	12.70	1.68
28S2001-0*0**	63.50	52.07	28.58	6.35	0.84
28S2001-2A2**	63.50	52.07	24.38	6.35	0.84
28S2011-0*0**	76.20	65.28	28.58	6.35	0.84
28R3149-000	79.98	68.58	12.70	11.99	1.91
28S2012-0M0**	88.90	78.23	28.58	6.48	0.84

** The "D" & "E" dimensions for 28S split, two-piece cores must be doubled for total assembled dimensions.

Custom parts are also available
 Refer to pages 17 - 21 for more data.

QUICK REFERENCE CHART

SORTED BY IMPEDANCE @ 100 MHz

BROADBAND 28 MATERIAL PARTS ONLY

ONE-PIECE (28R) & SPLIT (28S) CORES FOR RIBBON & FLEX CABLES

PART NUMBER Sorted by Impedance	Typical Impedance (Z) in Ohms (Ω)		
	@ 25 MHz	@ 100 MHz	@ 300 MHz
28R0610-000	29	80	216
28R1654-010	27	84	200
28R0386-000	36	96	224
28R1025-000	24	97	242
28R0614-100	36	98	245
28R0315-200	48	102	250
28R1418-000	34	104	245
28R0453-200	43	104	260
28R0756-000	40	107	258
28R0898-100	38	110	266
28R1127-500	40	110	265
28R1476-100	38	110	251
28R0669-000	41	110	270
28R0852-000	41	112	286
28R0945-000	43	112	269
28R0906-000	45	115	263
28R1319-000	43	117	269
28S2827-210	43	120	270
28R0454-100	45	121	269
28R0983-000	43	123	276
28R0354-100	50	125	269
28R0614-300	45	125	280
28R0898-200	43	127	280
28R1953-000	45	127	300
28R1024-000	48	128	299
28R1227-100	52	128	300
28R1450-100	48	130	290
28R1261-200	50	135	310
28R3149-000	51	135	318
28R1340-100	50	139	315

PART NUMBER Sorted by Impedance	Typical Impedance (Z) in Ohms (Ω)		
	@ 25 MHz	@ 100 MHz	@ 300 MHz
28R1101-000	55	140	300
28R0756-200	57	140	308
28R1457-400	44	140	310
28R1262-200	53	141	344
28R1128-200	52	145	312
28R0480-100	68	150	290
28R0492-100	68	150	290
28S0670-000	60	150	310
28R1127-400	60	150	330
28R1177-000	62	152	340
28R0453-300	65	153	335
28R1102-000	61	154	340
28R1236-000	78	162	370
28R1141-010	67	168	380
28R0394-000	92	169	294
28R2170-100	62	170	370
28R0984-200	70	170	370
28R1779-100	65	170	375
28R2000-010	63	170	380
28R1799-010	57	172	388
28R0551-100	71	176	352
28R0880-000	93	187	356
28R0480-000	100	190	320
28R0539-000	94	190	345
28R0825-000	96	190	363
28R1127-200	85	191	410
28R1102-100	75	192	380
28R0546-000	91	193	419
28R1128-100	79	204	399
28R1240-010	84	211	440

All chart data can be sorted on lairdtech.com
Refer to pages 17 - 21 for more data.

QUICK REFERENCE CHART

SORTED BY IMPEDANCE @ 100 MHz

BROADBAND 28 MATERIAL PARTS ONLY
ONE-PIECE (28R) & SPLIT (28S) CORES FOR RIBBON & FLEX CABLES

PART NUMBER Sorted by Impedance	Typical Impedance (Z) in Ohms (Ω)		
	@ 25 MHz	@ 100 MHz	@ 300 MHz
28R0984-000	100	220	430
28R1127-000	100	220	430
28R1340-200	86	220	449
28R0592-010	121	227	370
28R1181-000	92	227	450
28S2001-2A2	80	230	480
28R1103-000	95	230	480
28R1517-000	110	230	520
28R1518-000	105	235	478
28R1496-000	91	239	479
28S2012-0M0	80	240	630
28S2023-0M0	115	250	520
28S2022-0*0	100	250	550
28R2000-200	103	252	545
28R1262-000	110	260	520
28R1775-000	115	260	530
28R1800-010	110	260	555
28R1862-000	116	261	561
28R2170-000	110	280	550
28S2001-0*0	100	280	590
28S2011-0*0	100	280	600
28R1779-000	114	298	588
28R1261-100	140	350	700
28R1417-000	187	393	734

All chart data can be sorted on lairdtech.com
 Refer to pages 17 - 21 for more data.

FERRITE EMI DISKS AND PLATES



Ferrite disks and plates provide a simple, cost-effective solution for radiated and inductively-coupled electromagnetic interference. After the PC board soldering process, a ferrite disk or plate can be installed directly on the source of EMI (such as active devices or unwanted antennas).

FEATURES:

- Easy installation
- Each part for volume production is provided with permanent, double sided 3,5 mil acrylic adhesive with 218 oz. / inch² adhesion.
- Samples and sample kits are available with removable and reusable adhesive for "trial and error" testing
- Variety of sizes offered
- Custom parts also available.

APPLICATIONS:

- Ferrite disks and plates can be utilized either as inductively coupled components or EMI shields on PC board components and traces. Inductive coupling occurs when the ferrite affects the conducted wave form leaving the active component. The rise time of the wave form is effectively slowed by the ferrite, and the overshoot and associated ringing are attenuated. EMI shielding occurs when the ferrite absorbs the radiated emissions from active components, effectively protecting other boards or components in the vicinity from radiated contamination.
- Can be used to locate unwanted EMI antennas.
- Flat flex & ribbon cables.
- Can also provide retrofit, auxiliary EMI attenuation.

EXAMPLE APPLICATION

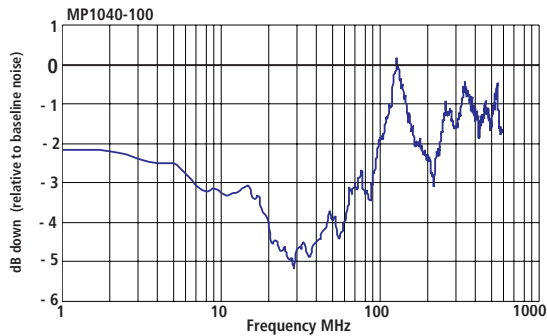

EXAMPLE APPLICATION GRAPH EXPLANATION:

The zero line on the graph represents the baseline noise recorded for an unprotected microprocessor. The curve (dB down) represent the performance of the Laird Technologies' ferrite plate relative to the baseline. The addition of the ferrite plates to the top of the processor in this specific application exhibits up to a 5 dB EMI reduction relative to the unprotected part. Performance can vary with different sizes, materials, processors and applications.

PART NUMBER	A mm (inches)	B mm (inches)	C mm (inches)
MM0650-100	16.51 (0.650)		1.27 (0.050)
MM0787-100	20.00 (0.787)		1.27 (0.050)
MM0787-200	20.00 (0.787)		1.91 (0.075)
MM1400-200	35.56 (1.400)		1.91 (0.075)
MM1400-300	35.56 (1.400)		2.54 (0.100)
MP0315-200	8.00 (0.315)	8.00 (0.315)	2.00 (0.079)
MP0350-000	26.42 (1.040)	8.89 (0.350)	1.27 (0.050)
MP0433-000	11.00 (0.433)	11.00 (0.433)	1.96 (0.077)
MP0512-200	13.00 (0.512)	13.00 (0.512)	2.00 (0.079)
MP0590-200	21.00 (0.827)	15.00 (0.591)	2.00 (0.079)
MP0591-200	15.00 (0.591)	15.00 (0.591)	2.00 (0.079)
MP0760-100	19.30 (0.760)	19.30 (0.760)	1.27 (0.050)
MP1040-100	26.42 (1.040)	26.42 (1.040)	1.27 (0.050)
MP1040-200	26.42 (1.040)	26.42 (1.040)	1.91 (0.075)
MP1040-300	26.42 (1.040)	26.42 (1.040)	2.25 (0.089)
MP1496-000	38.00 (1.496)	38.00 (1.496)	2.00 (0.079)

PART NUMBER SYSTEM EXAMPLE

H	M	0787	100
H - Material	M - Disk	Part Size	Thickness
M - Material	P - Plate	Identification	Code

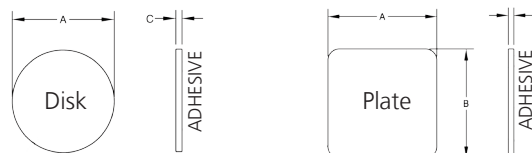

global solutions: local support™

Americas: +1.800.634.2673

Europe: +420.488.575277

ASEAN: +65.6243.8022

China: +86.757.2563.8860

India: +91.80.40740.400 x448

Japan: +81.45.473.6808

Korea: +82.10.8706.7469

Taiwan: +886.2.22901234 x163

www.lairdtech.com

ANTENNAS & RECEPTION

WIRELESS REMOTE CONTROL

EMI SOLUTIONS

THERMAL MANAGEMENT

WIRELESS M2M & TELEMATICS



Innovative Technology
for a Connected World

SIP-CAT-CABLE CORES 46 0811

Any information furnished by Laird Technologies, Inc. and its agents is believed to be accurate and reliable. All specifications are subject to change without notice. Responsibility for the use and application of Laird Technologies materials rests with the end user. Laird Technologies makes no warranties as to the fitness, merchantability, suitability or non-infringement of any Laird Technologies materials or products for any specific or general uses. Laird Technologies shall not be liable for incidental or consequential damages of any kind. All Laird Technologies products are sold pursuant to the Laird Technologies Terms and Conditions of sale in effect from time to time, a copy of which will be furnished upon request. © Copyright 2011 Laird Technologies, Inc. All Rights Reserved. Laird, Laird Technologies, the Laird Technologies Logo, and other marks are trade marks or registered trade marks of Laird Technologies, Inc. or an affiliate company thereof. Other product or service names may be the property of third parties. Nothing herein provides a license under any Laird Technologies or any third party intellectual property rights.