

EFM32LG995 DATASHEET

F256/F128/F64

Preliminary

- **ARM Cortex-M3 CPU platform**
 - High Performance 32-bit processor @ up to 48 MHz
 - Memory Protection Unit
- **Flexible Energy Management System**
 - 20 nA @ 3 V Shutoff Mode
 - 0.4µA @ 3 V Shutoff Mode with RTC
 - 0.9 µA @ 3 V Stop Mode, including Power-on Reset, Brown-out Detector, RAM and CPU retention
 - 1.1 µA @ 3 V Deep Sleep Mode, including RTC with 32.768 kHz oscillator, Power-on Reset, Brown-out Detector, RAM and CPU retention
 - 50 µA/MHz @ 3 V Sleep Mode
 - 200 µA/MHz @ 3 V Run Mode, with code executed from Flash
- **256/128/64 KB Flash**
- **32/32/32 KB RAM**
- **93 General Purpose I/O pins**
 - Configurable Push-pull, Open-drain, pull resistor, drive strength
 - Configurable peripheral I/O locations
 - 16 asynchronous external interrupts
 - Output state retention and wakeup from Shutoff Mode
- **12 Channel DMA Controller**
- **12 Channel Peripheral Reflex System (PRS) for autonomous inter-peripheral signaling**
- **Hardware AES with 128/256-bit keys in 54/75 cycles**
- **Timers/Counters**
 - 4x 16-bit Timer/Counter
 - 4x3 Compare/Capture/PWM channels
 - 16-bit Low Energy Timer
 - 1x 24-bit and 1x 32-bit Real-Time Counter
 - 3x 16/8-bit Pulse Counter with asynchronous operation
 - Watchdog Timer with dedicated RC oscillator @ 50 nA
- **Integrated LCD Controller for up to 8x36 segments**
 - Voltage boost, adjustable contrast and autonomous animation
- **Backup Power Domain**
 - RTC and retention registers in a separate power domain, available in all energy modes
 - Operation from backup battery when main power drains out
- **External Bus Interface for up to 4x256 MB of external memory mapped space**
 - TFT Controller with Direct Drive
- **Communication interfaces**
 - 3x Universal Synchronous/Asynchronous Receiver/Transmitter
 - UART/SPI/SmartCard (ISO 7816)/IrDA/I2S
 - 2x Universal Asynchronous Receiver/Transmitter
 - 2x Low Energy UART
 - Autonomous operation with DMA in Deep Sleep Mode
 - 2x I²C Interface with SMBus support
 - Address recognition in Stop Mode
 - Universal Serial Bus (USB) with Host and OTG support
 - Fully USB 2.0 compliant
 - On-chip PHY and embedded 5V to 3.3V regulator
- **Ultra low power precision analog peripherals**
 - 12-bit 1 Msamples/s Analog to Digital Converter
 - 8 single ended channels/4 differential channels
 - On-chip temperature sensor
 - 12-bit 500 ksamples/s Digital to Analog Converter
 - 2 single ended channels/1 differential channel
 - 2x Analog Comparator
 - Capacitive sensing with up to 16 inputs
 - 3x Operational Amplifier
 - 6.1 MHz GBW, Rail-to-rail, Programmable Gain
 - Supply Voltage Comparator
- **Low Energy Sensor Interface (LESENSE)**
 - Autonomous sensor monitoring in Deep Sleep Mode
 - Wide range of sensors supported, including LC sensors and capacitive buttons
- **Ultra efficient Power-on Reset and Brown-Out Detector**
- **Debug Interface**
 - 2-pin Serial Wire Debug interface
 - 1-pin Serial Wire Viewer
 - Embedded Trace Module v3.5 (ETM)
- **Pre-Programmed Serial Bootloader**
- **Temperature range -40 to 85 °C**
- **Single power supply 1.85 to 3.8 V**
- **BGA120 package**

32-bit ARM Cortex-M0+, Cortex-M3 and Cortex-M4F microcontrollers for:

- Energy, gas, water and smart metering
- Health and fitness applications
- Smart accessories
- Alarm and security systems
- Industrial and home automation
- www.energymicro.com/gecko



1 Ordering Information

Table 1.1 (p. 2) shows the available EFM32LG995 devices.

Table 1.1. Ordering Information

Ordering Code	Flash (KB)	RAM (KB)	Max Speed (MHz)	Supply Voltage (V)	Temperature	Package
EFM32LG995F64-BGA120	64	32	48	1.85 - 3.8	-40 - 85 °C	BGA120
EFM32LG995F128-BGA120	128	32	48	1.85 - 3.8	-40 - 85 °C	BGA120
EFM32LG995F256-BGA120	256	32	48	1.85 - 3.8	-40 - 85 °C	BGA120

Visit www.energymicro.com for information on global distributors and representatives or contact sales@energymicro.com for additional information.

2 System Summary

2.1 System Introduction

The EFM32 MCUs are the world's most energy friendly microcontrollers. With a unique combination of the powerful 32-bit ARM Cortex-M3, innovative low energy techniques, short wake-up time from energy saving modes, and a wide selection of peripherals, the EFM32LG microcontroller is well suited for any battery operated application as well as other systems requiring high performance and low-energy consumption. This section gives a short introduction to each of the modules in general terms and also shows a summary of the configuration for the EFM32LG995 devices. For a complete feature set and in-depth information on the modules, the reader is referred to the *EFM32LG Reference Manual*.

A block diagram of the EFM32LG995 is shown in Figure 2.1 (p. 3) .

Figure 2.1. Block Diagram

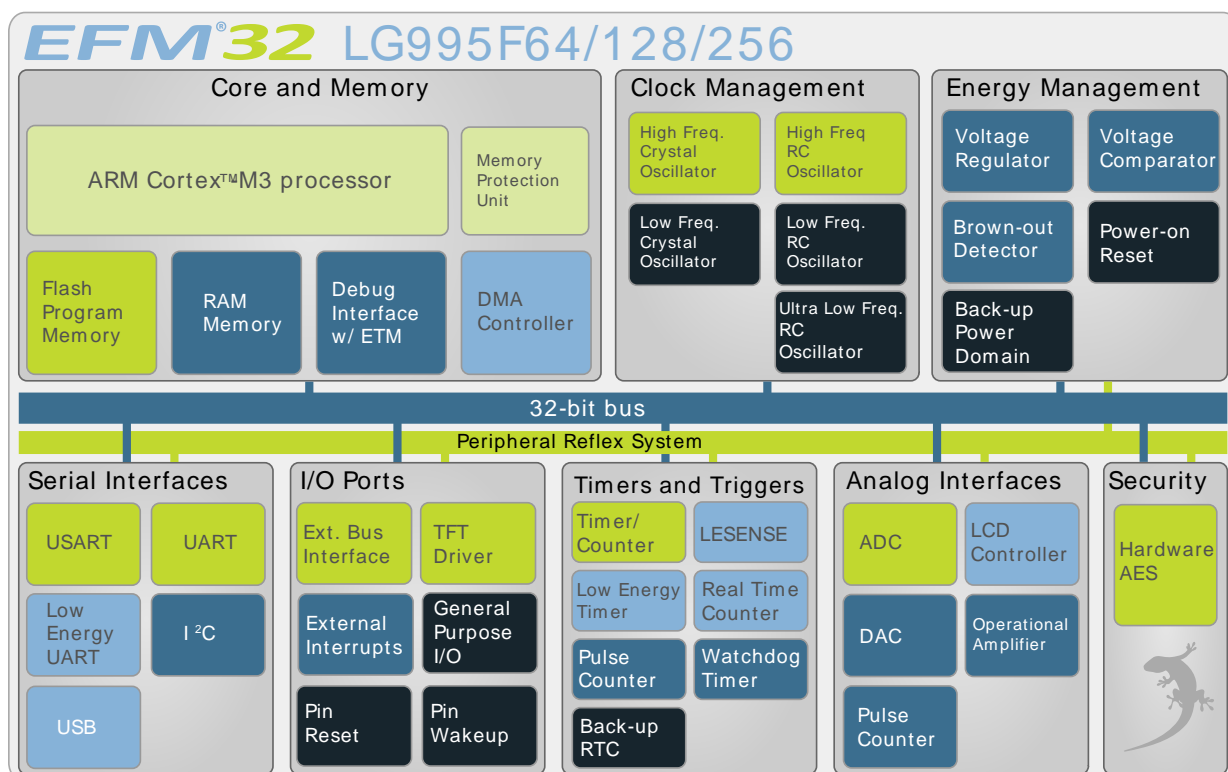

2.1.1 ARM Cortex-M3 Core

The ARM Cortex-M3 includes a 32-bit RISC processor which can achieve as much as 1.25 Dhrystone MIPS/MHz. A Memory Protection Unit with support for up to 8 memory segments is included, as well as a Wake-up Interrupt Controller handling interrupts triggered while the CPU is asleep. The EFM32 implementation of the Cortex-M3 is described in detail in *EFM32 Cortex-M3 Reference Manual*.

2.1.2 Debug Interface (DBG)

This device includes hardware debug support through a 2-pin serial-wire debug interface and an Embedded Trace Module (ETM) for data/instruction tracing. In addition there is also a 1-wire Serial Wire Viewer pin which can be used to output profiling information, data trace and software-generated messages.

2.1.3 Memory System Controller (MSC)

The Memory System Controller (MSC) is the program memory unit of the EFM32LG microcontroller. The flash memory is readable and writable from both the Cortex-M3 and DMA. The flash memory is divided

into two blocks; the main block and the information block. Program code is normally written to the main block. Additionally, the information block is available for special user data and flash lock bits. There is also a read-only page in the information block containing system and device calibration data. Read and write operations are supported in the energy modes EM0 and EM1.

2.1.4 Direct Memory Access Controller (DMA)

The Direct Memory Access (DMA) controller performs memory operations independently of the CPU. This has the benefit of reducing the energy consumption and the workload of the CPU, and enables the system to stay in low energy modes when moving for instance data from the USART to RAM or from the External Bus Interface to a PWM-generating timer. The DMA controller uses the PL230 μ DMA controller licensed from ARM.

2.1.5 Reset Management Unit (RMU)

The RMU is responsible for handling the reset functionality of the EFM32LG.

2.1.6 Energy Management Unit (EMU)

The Energy Management Unit (EMU) manage all the low energy modes (EM) in EFM32LG microcontrollers. Each energy mode manages if the CPU and the various peripherals are available. The EMU can also be used to turn off the power to unused SRAM blocks.

2.1.7 Clock Management Unit (CMU)

The Clock Management Unit (CMU) is responsible for controlling the oscillators and clocks on-board the EFM32LG. The CMU provides the capability to turn on and off the clock on an individual basis to all peripheral modules in addition to enable/disable and configure the available oscillators. The high degree of flexibility enables software to minimize energy consumption in any specific application by not wasting power on peripherals and oscillators that are inactive.

2.1.8 Watchdog (WDOG)

The purpose of the watchdog timer is to generate a reset in case of a system failure, to increase application reliability. The failure may e.g. be caused by an external event, such as an ESD pulse, or by a software failure.

2.1.9 Peripheral Reflex System (PRS)

The Peripheral Reflex System (PRS) system is a network which lets the different peripheral module communicate directly with each other without involving the CPU. Peripheral modules which send out Reflex signals are called producers. The PRS routes these reflex signals to consumer peripherals which apply actions depending on the data received. The format for the Reflex signals is not given, but edge triggers and other functionality can be applied by the PRS.

2.1.10 External Bus Interface (EBI)

The External Bus Interface provides access to external parallel interface devices such as SRAM, FLASH, ADCs and LCDs. The interface is memory mapped into the address bus of the Cortex-M3. This enables seamless access from software without manually manipulating the IO settings each time a read or write is performed. The data and address lines are multiplexed in order to reduce the number of pins required to interface the external devices. The timing is adjustable to meet specifications of the external devices. The interface is limited to asynchronous devices.

2.1.11 TFT Direct Drive

The EBI contains a TFT controller which can drive a TFT via a 565 RGB interface. The TFT controller supports programmable display and port sizes and offers accurate control of frequency and setup and

hold timing. Direct Drive is supported for TFT displays which do not have their own frame buffer. In that case TFT Direct Drive can transfer data from either on-chip memory or from an external memory device to the TFT at low CPU load. Automatic alpha-blending and masking is also supported for transfers through the EBI interface.

2.1.12 Universal Serial Bus Controller (USB)

The USB is a full-speed USB 2.0 compliant OTG host/device controller. The USB can be used in Device, On-the-go (OTG) Dual Role Device or Host-only configuration. In OTG mode the USB supports both Host Negotiation Protocol (HNP) and Session Request Protocol (SRP). The device supports both full-speed (12MBit/s) and low speed (1.5MBit/s) operation. The USB device includes an internal dedicated Descriptor-Based Scatter/Gather DMA and supports up to 6 OUT endpoints and 6 IN endpoints, in addition to endpoint 0. The on-chip PHY includes all OTG features, except for the voltage booster for supplying 5V to VBUS when operating as host.

2.1.13 Inter-Integrated Circuit Interface (I2C)

The I²C module provides an interface between the MCU and a serial I²C-bus. It is capable of acting as both a master and a slave, and supports multi-master buses. Both standard-mode, fast-mode and fast-mode plus speeds are supported, allowing transmission rates all the way from 10 kbit/s up to 1 Mbit/s. Slave arbitration and timeouts are also provided to allow implementation of an SMBus compliant system. The interface provided to software by the I²C module, allows both fine-grained control of the transmission process and close to automatic transfers. Automatic recognition of slave addresses is provided in all energy modes.

2.1.14 Universal Synchronous/Asynchronous Receiver/Transmitter (USART)

The Universal Synchronous Asynchronous serial Receiver and Transmitter (USART) is a very flexible serial I/O module. It supports full duplex asynchronous UART communication as well as RS-485, SPI, MicroWire and 3-wire. It can also interface with ISO7816 SmartCards, I2S devices and IrDA devices.

2.1.15 Pre-Programmed Serial Bootloader

The bootloader presented in application note AN0003 is pre-programmed in the device at factory. Auto-baud and destructive write are supported. The autobaud feature, interface and commands are described further in the application note.

2.1.16 Universal Asynchronous Receiver/Transmitter (UART)

The Universal Asynchronous serial Receiver and Transmitter (UART) is a very flexible serial I/O module. It supports full- and half-duplex asynchronous UART communication.

2.1.17 Low Energy Universal Asynchronous Receiver/Transmitter (LEUART)

The unique LEUARTTM, the Low Energy UART, is a UART that allows two-way UART communication on a strict power budget. Only a 32.768 kHz clock is needed to allow UART communication up to 9600 baud/s. The LEUART includes all necessary hardware support to make asynchronous serial communication possible with minimum of software intervention and energy consumption.

2.1.18 Timer/Counter (TIMER)

The 16-bit general purpose Timer has 3 compare/capture channels for input capture and compare/Pulse-Width Modulation (PWM) output. TIMER0 also includes a Dead-Time Insertion module suitable for motor control applications.

2.1.19 Real Time Counter (RTC)

The Real Time Counter (RTC) contains a 24-bit counter and is clocked either by a 32.768 kHz crystal oscillator, or a 32.768 kHz RC oscillator. In addition to energy modes EM0 and EM1, the RTC is also available in EM2. This makes it ideal for keeping track of time since the RTC is enabled in EM2 where most of the device is powered down.

2.1.20 Backup Real Time Counter (BURTC)

The Backup Real Time Counter (BURTC) contains a 32-bit counter and is clocked either by a 32.768 kHz crystal oscillator, a 32.768 kHz RC oscillator or a 1 kHz ULFRCO. The BURTC is available in all Energy Modes and it can also run in backup mode, making it operational even if the main power should drain out.

2.1.21 Low Energy Timer (LETIMER)

The unique LETIMER[™], the Low Energy Timer, is a 16-bit timer that is available in energy mode EM2 in addition to EM1 and EM0. Because of this, it can be used for timing and output generation when most of the device is powered down, allowing simple tasks to be performed while the power consumption of the system is kept at an absolute minimum. The LETIMER can be used to output a variety of waveforms with minimal software intervention. It is also connected to the Real Time Counter (RTC), and can be configured to start counting on compare matches from the RTC.

2.1.22 Pulse Counter (PCNT)

The Pulse Counter (PCNT) can be used for counting pulses on a single input or to decode quadrature encoded inputs. It runs off either the internal LFACLK or the PCNTn_S0IN pin as external clock source. The module may operate in energy mode EM0 – EM3.

2.1.23 Analog Comparator (ACMP)

The Analog Comparator is used to compare the voltage of two analog inputs, with a digital output indicating which input voltage is higher. Inputs can either be one of the selectable internal references or from external pins. Response time and thereby also the current consumption can be configured by altering the current supply to the comparator.

2.1.24 Voltage Comparator (VCMP)

The Voltage Supply Comparator is used to monitor the supply voltage from software. An interrupt can be generated when the supply falls below or rises above a programmable threshold. Response time and thereby also the current consumption can be configured by altering the current supply to the comparator.

2.1.25 Analog to Digital Converter (ADC)

The ADC is a Successive Approximation Register (SAR) architecture, with a resolution of up to 12 bits at up to one million samples per second. The integrated input mux can select inputs from 8 external pins and 6 internal signals.

2.1.26 Digital to Analog Converter (DAC)

The Digital to Analog Converter (DAC) can convert a digital value to an analog output voltage. The DAC is fully differential rail-to-rail, with 12-bit resolution. It has two single ended output buffers which can be combined into one differential output. The DAC may be used for a number of different applications such as sensor interfaces or sound output.

2.1.27 Operational Amplifier (OPAMP)

The EFM32LG995 features 3 Operational Amplifiers. The Operational Amplifier is a versatile general purpose amplifier with rail-to-rail differential input and rail-to-rail single ended output. The input can be set

to pin, DAC or OPAMP, whereas the output can be pin, OPAMP or ADC. The current is programmable and the OPAMP has various internal configurations such as unity gain, programmable gain using internal resistors etc.

2.1.28 Low Energy Sensor Interface (LESENSE)

The Low Energy Sensor Interface (LESENSE[™]), is a highly configurable sensor interface with support for up to 16 individually configurable sensors. By controlling the analog comparators and DAC, LESENSE is capable of supporting a wide range of sensors and measurement schemes, and can for instance measure LC sensors, resistive sensors and capacitive sensors. LESENSE also includes a programmable FSM which enables simple processing of measurement results without CPU intervention. LESENSE is available in energy mode EM2, in addition to EM0 and EM1, making it ideal for sensor monitoring in applications with a strict energy budget.

2.1.29 Backup Power Domain

The backup power domain is a separate power domain containing a Backup Real Time Counter, BURTC, and a set of retention registers, available in all energy modes. This power domain can be configured to automatically change power source to a backup battery when the main power drains out. The backup power domain enables the EFM32LG995 to keep track of time and retain data, even if the main power source should drain out.

2.1.30 Advanced Encryption Standard Accelerator (AES)

The AES accelerator performs AES encryption and decryption with 128-bit or 256-bit keys. Encrypting or decrypting one 128-bit data block takes 52 HFCORECLK cycles with 128-bit keys and 75 HFCORECLK cycles with 256-bit keys. The AES module is an AHB slave which enables efficient access to the data and key registers. All write accesses to the AES module must be 32-bit operations, i.e. 8- or 16-bit operations are not supported.

2.1.31 General Purpose Input/Output (GPIO)

In the EFM32LG995, there are 93 General Purpose Input/Output (GPIO) pins, which are divided into ports with up to 16 pins each. These pins can individually be configured as either an output or input. More advanced configurations like open-drain, filtering and drive strength can also be configured individually for the pins. The GPIO pins can also be overridden by peripheral pin connections, like Timer PWM outputs or USART communication, which can be routed to several locations on the device. The GPIO supports up to 16 asynchronous external pin interrupts, which enables interrupts from any pin on the device. Also, the input value of a pin can be routed through the Peripheral Reflex System to other peripherals.

2.1.32 Liquid Crystal Display Driver (LCD)

The LCD driver is capable of driving a segmented LCD display with up to segments. A voltage boost function enables it to provide the LCD display with higher voltage than the supply voltage for the device. In addition, an animation feature can run custom animations on the LCD display without any CPU intervention. The LCD driver can also remain active even in Energy Mode 2 and provides a Frame Counter interrupt that can wake-up the device on a regular basis for updating data.

2.2 Configuration Summary

The features of the EFM32LG995 is a subset of the feature set described in the EFM32LG Reference Manual. Table 2.1 (p. 7) describes device specific implementation of the features.

Table 2.1. Configuration Summary

Module	Configuration	Pin Connections
Cortex-M3	Full configuration	NA

Module	Configuration	Pin Connections
DBG	Full configuration	DBG_SWCLK, DBG_SWDIO, DBG_SWO
MSC	Full configuration	NA
DMA	Full configuration	NA
RMU	Full configuration	NA
EMU	Full configuration	NA
CMU	Full configuration	CMU_OUT0, CMU_OUT1
WDOG	Full configuration	NA
PRS	Full configuration	NA
USB	Full configuration	USB_VBUS, USB_VBUSEN, USB_VREGI, USB_VREGO, USB_DM, USB_DMPU, USB_DP, USB_ID
EBI	Full configuration	EBI_A[27:0], EBI_AD[15:0], EBI_ARDY, EBI_ALE, EBI_BL[1:0], EBI_CS[3:0], EBI_CSTFT, EBI_DCLK, EBI_DTEN, EBI_HSNC, EBI_NANDREn, EBI_NANDWEn, EBI_REn, EBI_VSNC, EBI_WEn
I2C0	Full configuration	I2C0_SDA, I2C0_SCL
I2C1	Full configuration	I2C1_SDA, I2C1_SCL
USART0	IrDA	US0_TX, US0_RX, US0_CLK, US0_CS
USART1	I2S	US1_TX, US1_RX, US1_CLK, US1_CS
USART2	I2S	US2_TX, US2_RX, US2_CLK, US2_CS
UART0	Full configuration	U0_TX, U0_RX
UART1	Full configuration	U1_TX, U1_RX
LEUART0	Full configuration	LEU0_TX, LEU0_RX
LEUART1	Full configuration	LEU1_TX, LEU1_RX
TIMER0	Full configuration with DTI.	TIM0_CC[2:0], TIM0_CDTI[2:0]
TIMER1	Full configuration	TIM1_CC[2:0]
TIMER2	Full configuration	TIM2_CC[2:0]
TIMER3	Full configuration	TIM3_CC[2:0]
RTC	Full configuration	NA
BURTC	Full configuration	NA
LETIMER0	Full configuration	LET0_O[1:0]
PCNT0		PCNT0_S[1:0]
PCNT1	8-bit count register	PCNT1_S[1:0]
PCNT2	8-bit count register	PCNT2_S[1:0]
ACMP0	Full configuration	ACMP0_CH[7:0], ACMP0_O
ACMP1	Full configuration	ACMP1_CH[7:0], ACMP1_O
VCMP	Full configuration	NA
ADC0	Full configuration	ADC0_CH[7:0]

Module	Configuration	Pin Connections
DAC0	Full configuration	DAC0_OUT[1:0], DAC0_OUTxALT
OPAMP		
AES	Full configuration	NA
GPIO	93 pins	Available pins are shown in Table 4.3 (p. 59)
LCD	Full configuration	LCD_SEG[35:0], LCD_COM[7:0], LCD_BCAP_P, LCD_BCAP_N, LCD_BEXT

2.3 Memory Map

The EFM32LG995 memory map is shown in Figure 2.2 (p. 9), with RAM and Flash sizes for the largest memory configuration.

Figure 2.2. EFM32LG995 Memory Map with largest RAM and Flash sizes

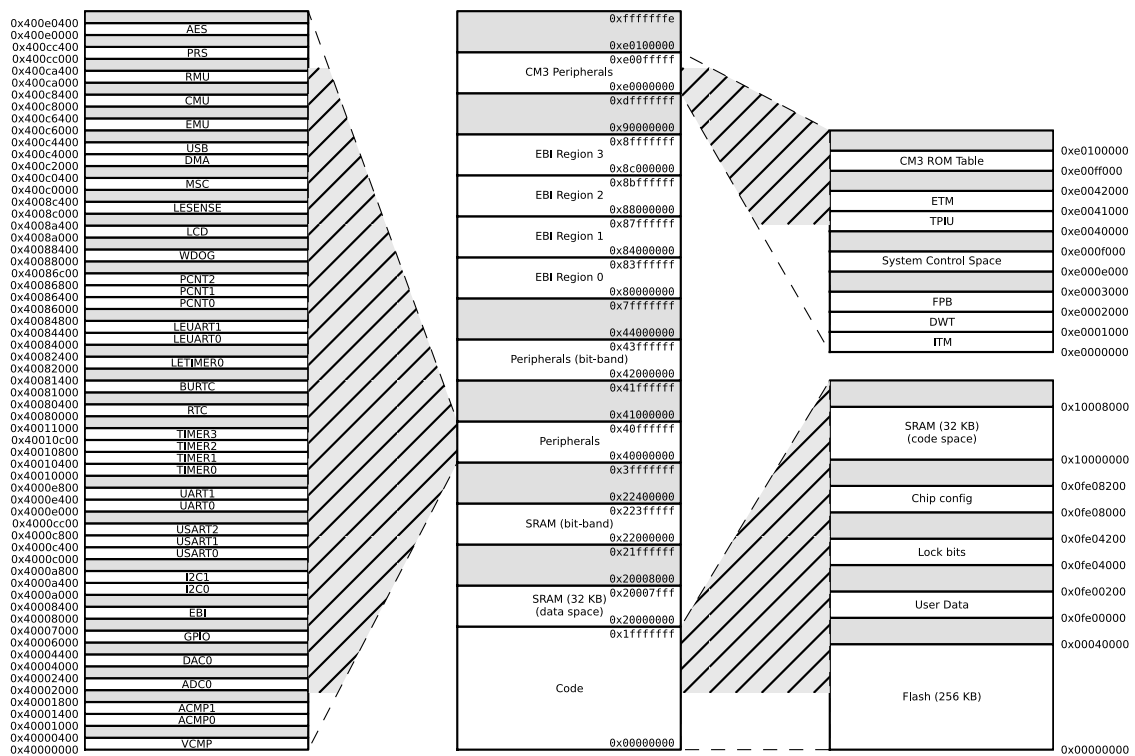

3 Electrical Characteristics

3.1 Test Conditions

3.1.1 Typical Values

The typical data are based on $T_{AMB}=25^{\circ}\text{C}$ and $V_{DD}=3.0\text{ V}$, as defined in Table 3.2 (p. 10), by simulation and/or technology characterisation unless otherwise specified.

3.1.2 Minimum and Maximum Values

The minimum and maximum values represent the worst conditions of ambient temperature, supply voltage and frequencies, as defined in Table 3.2 (p. 10), by simulation and/or technology characterisation unless otherwise specified.

3.2 Absolute Maximum Ratings

The absolute maximum ratings are stress ratings, and functional operation under such conditions are not guaranteed. Stress beyond the limits specified in Table 3.1 (p. 10) may affect the device reliability or cause permanent damage to the device. Functional operating conditions are given in Table 3.2 (p. 10).

Table 3.1. Absolute Maximum Ratings

Symbol	Parameter	Condition	Min	Typ	Max	Unit
T_{STG}	Storage temperature range		-40		150 ¹	$^{\circ}\text{C}$
T_S	Maximum soldering temperature	Latest IPC/JEDEC J-STD-020 Standard			260	$^{\circ}\text{C}$
V_{DDMAX}	External main supply voltage		0		3.8	V
V_{IOPIN}	Voltage on any I/O pin		-0.3		$V_{DD}+0.3$	V

¹Based on programmed devices tested for 10000 hours at 150°C . Storage temperature affects retention of preprogrammed calibration values stored in flash. Please refer to the Flash section in the Electrical Characteristics for information on flash data retention for different temperatures.

3.3 General Operating Conditions

3.3.1 General Operating Conditions

Table 3.2. General Operating Conditions

Symbol	Parameter	Min	Typ	Max	Unit
T_{AMB}	Ambient temperature range	-40		85	$^{\circ}\text{C}$
V_{DDOP}	Operating supply voltage	1.85		3.8	V
f_{APB}	Internal APB clock frequency			48	MHz
f_{AHB}	Internal AHB clock frequency			48	MHz

3.3.2 Environmental

Table 3.3. Environmental

Symbol	Parameter	Condition	Min	Typ	Max	Unit
V _{ESDHBM}	ESD (Human Body Model HBM)	T _{AMB} =25°C			2	kV
V _{ESDCDM}	ESD (Charged Device Model, CDM)	T _{AMB} =25°C			1	kV

Latch-up sensitivity test passed level A according to JEDEC JESD 78B method Class II, 85°C.

3.4 Current Consumption

Table 3.4. Current Consumption

Symbol	Parameter	Condition	Min	Typ	Max	Unit
I_{EM0}	EM0 current. No prescaling. Running prime number calculation code from Flash.	32 MHz HFXO, all peripheral clocks disabled, $V_{DD}=3.0\text{ V}$		200		$\mu\text{A}/\text{MHz}$
		28 MHz HFRCO, all peripheral clocks disabled, $V_{DD}=3.0\text{ V}$		201	261	$\mu\text{A}/\text{MHz}$
		21 MHz HFRCO, all peripheral clocks disabled, $V_{DD}=3.0\text{ V}$		203	263	$\mu\text{A}/\text{MHz}$
		14 MHz HFRCO, all peripheral clocks disabled, $V_{DD}=3.0\text{ V}$		204	270	$\mu\text{A}/\text{MHz}$
		11 MHz HFRCO, all peripheral clocks disabled, $V_{DD}=3.0\text{ V}$		207	273	$\mu\text{A}/\text{MHz}$
		6.6 MHz HFRCO, all peripheral clocks disabled, $V_{DD}=3.0\text{ V}$		212	282	$\mu\text{A}/\text{MHz}$
		1.2 MHz HFRCO, all peripheral clocks disabled, $V_{DD}=3.0\text{ V}$		244		$\mu\text{A}/\text{MHz}$
I_{EM1}	EM1 current	32 MHz HFXO, all peripheral clocks disabled, $V_{DD}=3.0\text{ V}$		50		$\mu\text{A}/\text{MHz}$
		28 MHz HFRCO, all peripheral clocks disabled, $V_{DD}=3.0\text{ V}$		52	69	$\mu\text{A}/\text{MHz}$
		21 MHz HFRCO, all peripheral clocks disabled, $V_{DD}=3.0\text{ V}$		53	71	$\mu\text{A}/\text{MHz}$
		14 MHz HFRCO, all peripheral clocks disabled, $V_{DD}=3.0\text{ V}$		56	77	$\mu\text{A}/\text{MHz}$
		11 MHz HFRCO, all peripheral clocks disabled, $V_{DD}=3.0\text{ V}$		57	80	$\mu\text{A}/\text{MHz}$
		6.6 MHz HFRCO, all peripheral clocks disabled, $V_{DD}=3.0\text{ V}$		62	92	$\mu\text{A}/\text{MHz}$
		1.2 MHz HFRCO, all peripheral clocks disabled, $V_{DD}=3.0\text{ V}$		114		$\mu\text{A}/\text{MHz}$
I_{EM2}	EM2 current	EM2 current with RTC at 1 Hz, RTC prescaled to 1kHz, 32.768 kHz LFRCO, $V_{DD}=3.0\text{ V}$, $T_{AMB}=25^{\circ}\text{C}$		1.1		μA
		EM2 current with RTC at 1 Hz, RTC prescaled to 1kHz, 32.768 kHz LFRCO, $V_{DD}=3.0\text{ V}$, $T_{AMB}=85^{\circ}\text{C}$		4.0	8.0	μA
I_{EM3}	EM3 current	$V_{DD}=3.0\text{ V}$, $T_{AMB}=25^{\circ}\text{C}$		0.9		μA
		$V_{DD}=3.0\text{ V}$, $T_{AMB}=85^{\circ}\text{C}$		3.8	7.8	μA
I_{EM4}	EM4 current	$V_{DD}=3.0\text{ V}$, $T_{AMB}=25^{\circ}\text{C}$		0.02		μA
		$V_{DD}=3.0\text{ V}$, $T_{AMB}=85^{\circ}\text{C}$		0.25	0.7	μA

3.5 Transition between Energy Modes

Table 3.5. Energy Modes Transitions

Symbol	Parameter	Min	Typ	Max	Unit
t_{EM10}	Transition time from EM1 to EM0		0 ¹		HF core CLK cycles
t_{EM20}	Transition time from EM2 to EM0		2		μ s
t_{EM30}	Transition time from EM3 to EM0		2		μ s
t_{EM40}	Transition time from EM4 to EM0		163		μ s

¹Core wakeup time only.

3.6 Power Management

Table 3.6. Power Management

Symbol	Parameter	Condition	Min	Typ	Max	Unit
$V_{BODextthr-}$	BOD threshold on falling external supply voltage		1.82		1.85	V
$V_{BODintthr-}$	BOD threshold on falling internally regulated supply voltage		1.62		1.68	V
$V_{BODextthr+}$	BOD threshold on rising external supply voltage			1.85		V
$V_{PORthr+}$	Power-on Reset (POR) threshold on rising external supply voltage				1.98	V
t_{RESET}	Delay from reset is released until program execution starts	Applies to Power-on Reset, Brown-out Reset and pin reset.		163		μ s
$C_{DECOUPLE}$	Voltage regulator decoupling capacitor.	X5R capacitor recommended. Apply between DECOUPLE pin and GROUND		1		μ F
C_{USB_VREGO}	USB voltage regulator out decoupling capacitor.	X5R capacitor recommended. Apply between USB_VREGO pin and GROUND		1		μ F
C_{USB_VREGI}	USB voltage regulator in decoupling capacitor.	X5R capacitor recommended. Apply between USB_VREGI pin and GROUND		4.7		μ F

3.7 Flash

Table 3.7. Flash

Symbol	Parameter	Condition	Min	Typ	Max	Unit
EC _{FLASH}	Flash erase cycles before failure		20000			cycles
RET _{FLASH}	Flash data retention	T _{AMB} <150°C	10000			h
		T _{AMB} <85°C	10			years
		T _{AMB} <70°C	20			years
t _{W_PROG}	Word (32-bit) programming time		20			μs
t _{PERASE}	Page erase time	< 512KB	20	20.4	20.8	ms
		>= 512KB, LPERASE == 0	20	20.4	20.8	ms
		>= 512KB, LPERASE == 1	40	40.4	40.8	ms
t _{DERASE}	Device erase time	< 512KB	40	40.8	41.6	ms
		>= 512KB			161.6	ms
I _{ERASE}	Erase current	< 512KB			7 ¹	mA
		>= 512KB, LPERASE == 0			14 ¹	mA
		>= 512KB, LPERASE == 1			7 ¹	mA
I _{WRITE}	Write current	< 512KB			7 ¹	mA
		>= 512KB, LPWRITE == 0			14 ¹	mA
		>= 512KB, LPWRITE == 1			7 ¹	mA
V _{FLASH}	Supply voltage during flash erase and write		1.8		3.8	V

¹Measured at 25°C

3.8 General Purpose Input Output

Table 3.8. GPIO

Symbol	Parameter	Condition	Min	Typ	Max	Unit
V _{IOIL}	Input low voltage				0.3V _{DD}	V
V _{IOIH}	Input high voltage		0.7V _{DD}			V
V _{IOOH}	Output high voltage	Sourcing 6 mA, V _{DD} =1.8V, GPIO_PX_CTRL DRIVE-MODE = STANDARD	0.75V _{DD}			V
		Sourcing 6 mA, V _{DD} =3.0V, GPIO_PX_CTRL DRIVE-MODE = STANDARD	0.95V _{DD}			V
		Sourcing 20 mA, V _{DD} =1.8V, GPIO_PX_CTRL DRIVE-MODE = HIGH	0.7V _{DD}			V
		Sourcing 20 mA, V _{DD} =3.0V, GPIO_PX_CTRL DRIVE-MODE = HIGH	0.9V _{DD}			V
V _{IOOL}	Output low voltage	Sinking 6 mA, V _{DD} =1.8V, GPIO_PX_CTRL DRIVE-MODE = STANDARD			0.25V _{DD}	V
		Sinking 6 mA, V _{DD} =3.0V, GPIO_PX_CTRL DRIVE-MODE = STANDARD			0.05V _{DD}	V
		Sinking 20 mA, V _{DD} =1.8V, GPIO_PX_CTRL DRIVE-MODE = HIGH			0.3V _{DD}	V
		Sinking 20 mA, V _{DD} =3.0V, GPIO_PX_CTRL DRIVE-MODE = HIGH			0.1V _{DD}	V
I _{IOLEAK}	Input leakage current	High Impedance IO connected to GROUND or V _{DD}			+/-25	nA
R _{PU}	I/O pin pull-up resistor			40		kOhm
R _{PD}	I/O pin pull-down resistor			40		kOhm
R _{IOESD}	Internal ESD series resistor			200		Ohm
t _{IOGLITCH}	Pulse width of pulses to be removed by the glitch suppression filter		10		50	ns
t _{IOOF}	Output fall time	0.5 mA drive strength and load capacitance C _L =12.5-25pF.	20+0.1C _L		250	ns
		2mA drive strength and load capacitance C _L =350-600pF	20+0.1C _L		250	ns
V _{IOHYST}	I/O pin hysteresis (V _{IOTHR+} - V _{IOTHR-})	V _{DD} = 1.8 - 3.8 V	0.1V _{DD}			V

Figure 3.1. Typical Low-Level Output Current, 2V Supply Voltage

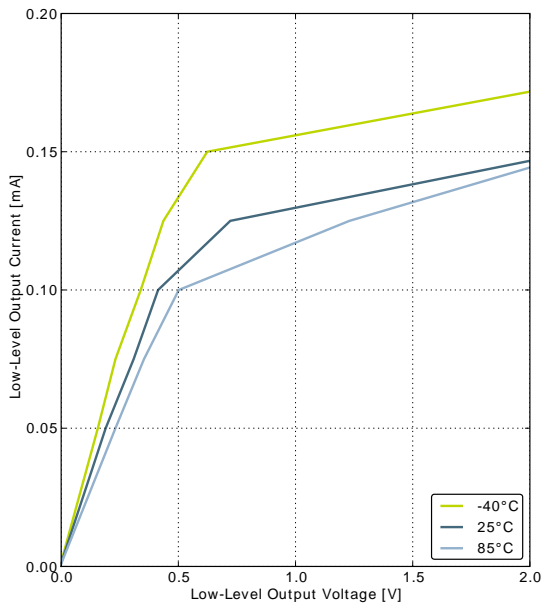

GPIO_Px_CTRL DRIVEMODE = LOWEST

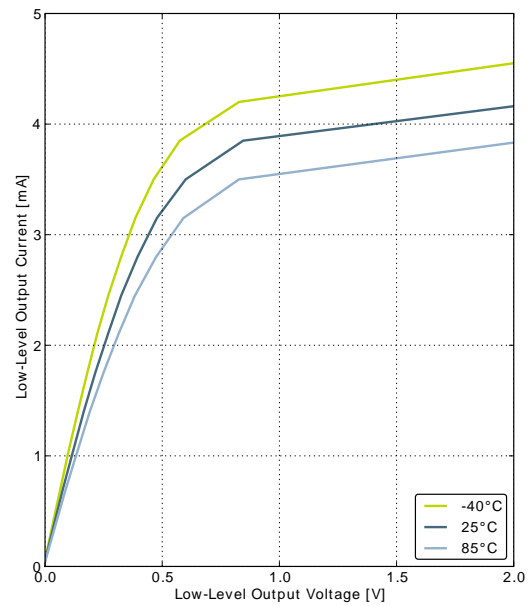

GPIO_Px_CTRL DRIVEMODE = LOW

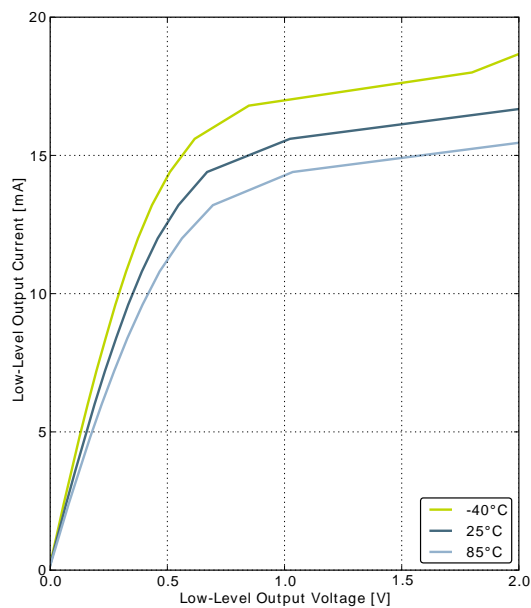

GPIO_Px_CTRL DRIVEMODE = STANDARD

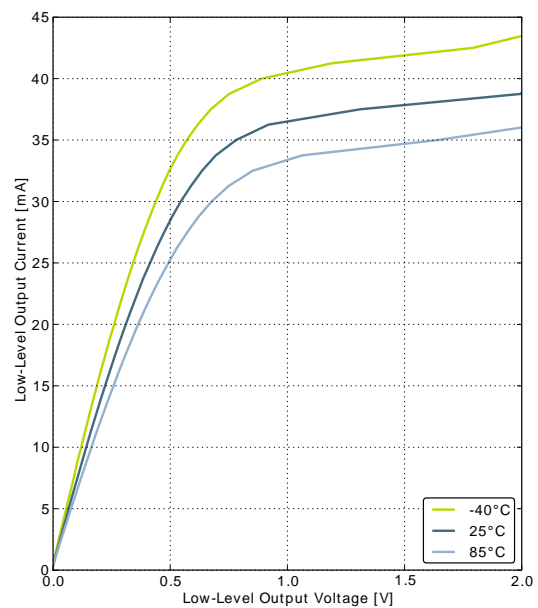

GPIO_Px_CTRL DRIVEMODE = HIGH

Figure 3.2. Typical High-Level Output Current, 2V Supply Voltage

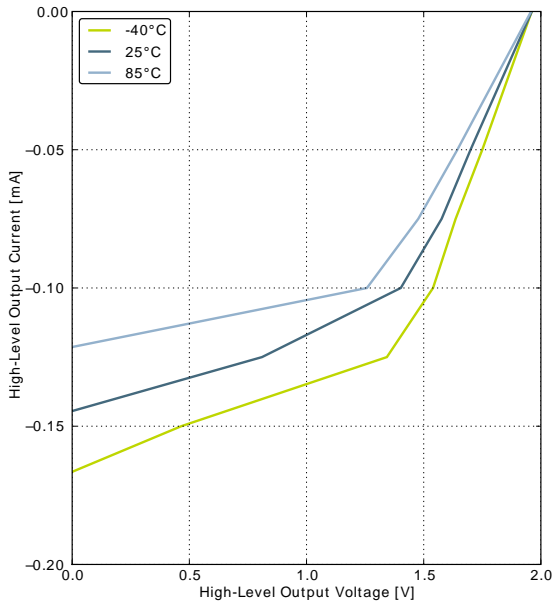

GPIO_Px_CTRL DRIVEMODE = LOWEST

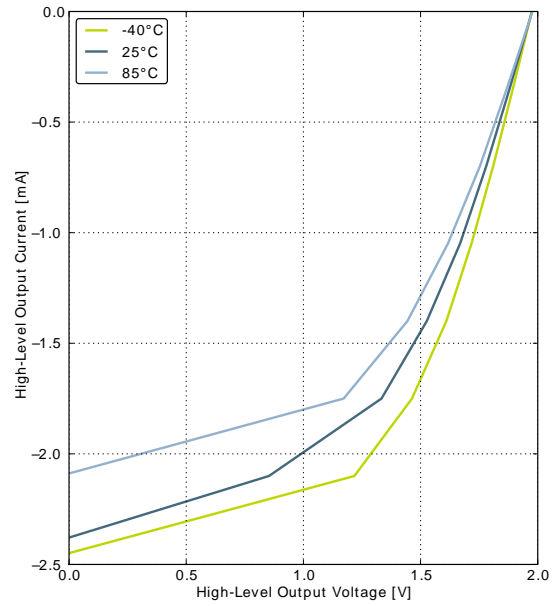

GPIO_Px_CTRL DRIVEMODE = LOW

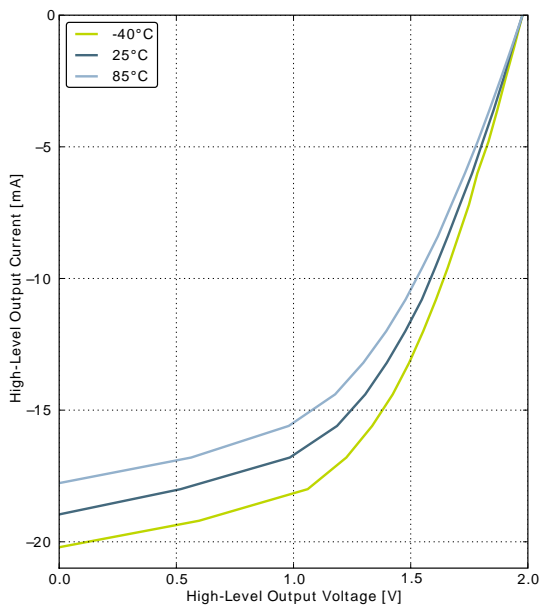

GPIO_Px_CTRL DRIVEMODE = STANDARD

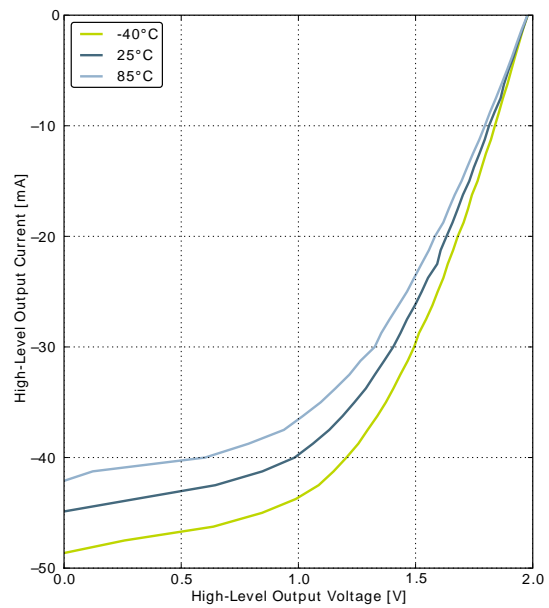

GPIO_Px_CTRL DRIVEMODE = HIGH

Figure 3.3. Typical Low-Level Output Current, 3V Supply Voltage

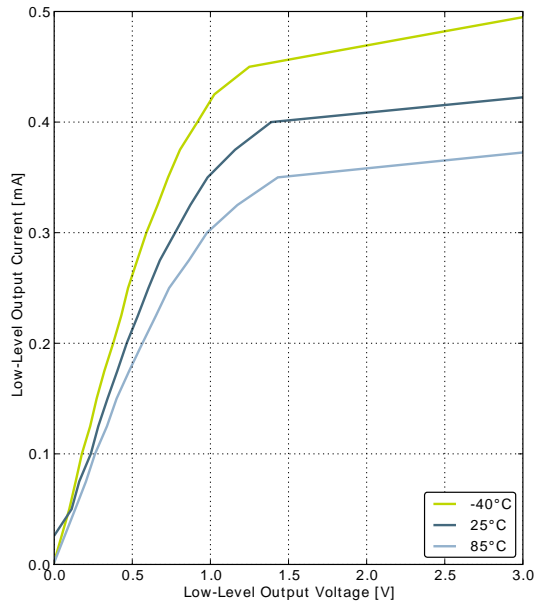

GPIO_Px_CTRL DRIVEMODE = LOWEST

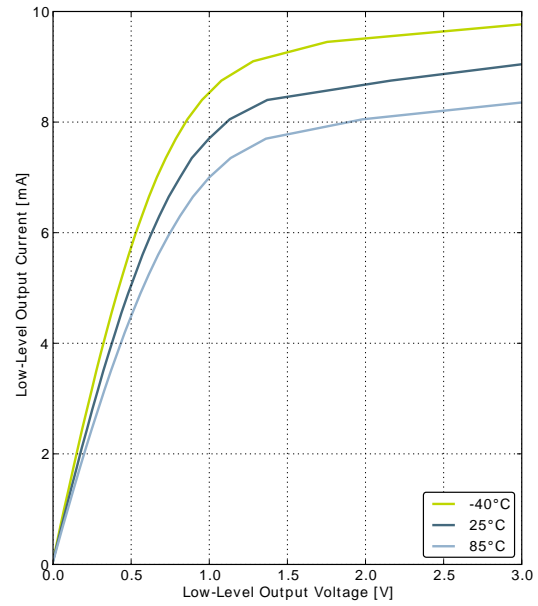

GPIO_Px_CTRL DRIVEMODE = LOW

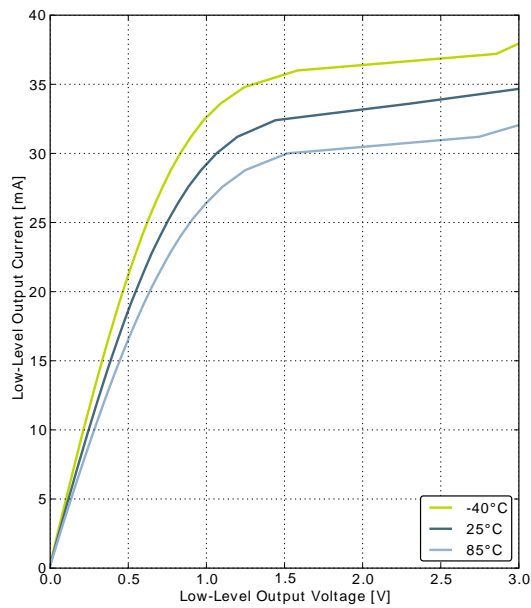

GPIO_Px_CTRL DRIVEMODE = STANDARD

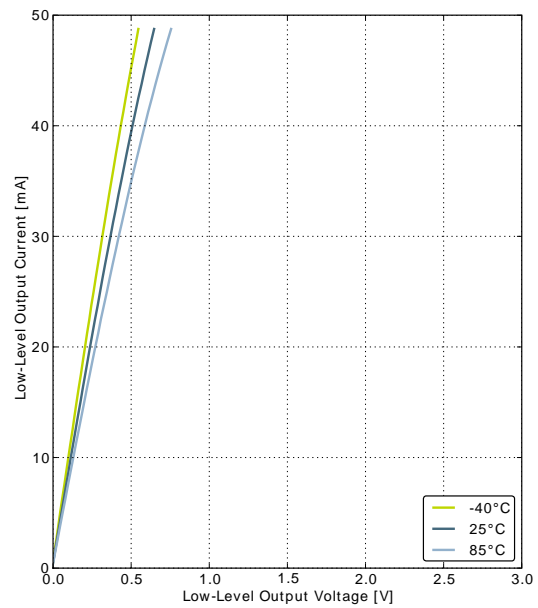

GPIO_Px_CTRL DRIVEMODE = HIGH

Figure 3.4. Typical High-Level Output Current, 3V Supply Voltage

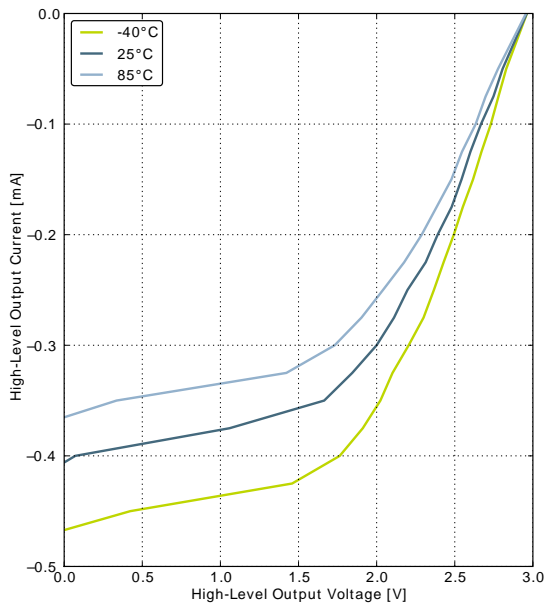

GPIO_Px_CTRL DRIVEMODE = LOWEST

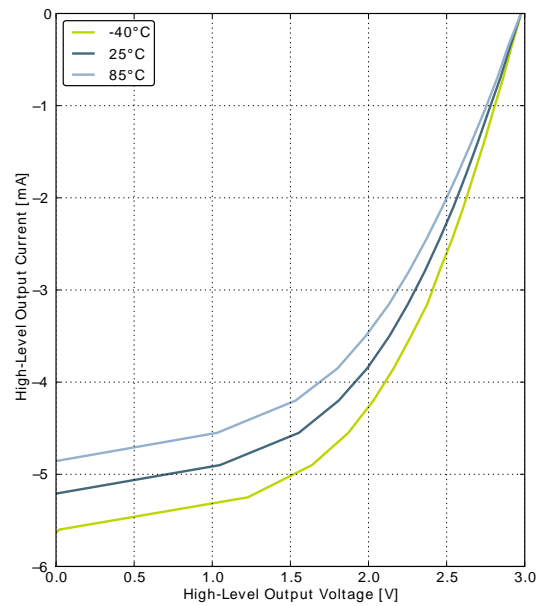

GPIO_Px_CTRL DRIVEMODE = LOW

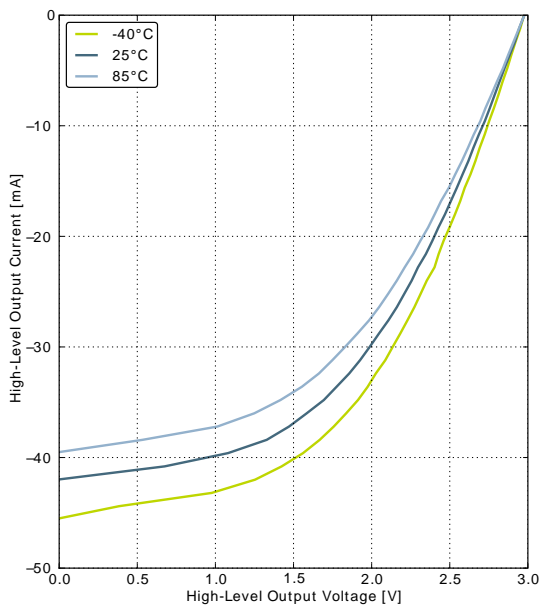

GPIO_Px_CTRL DRIVEMODE = STANDARD

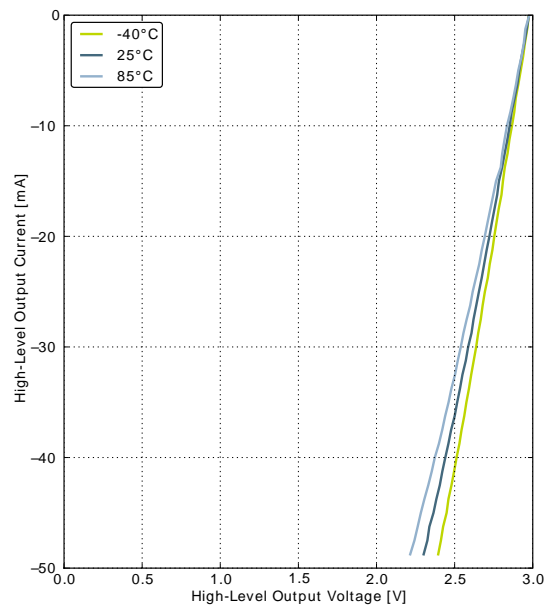

GPIO_Px_CTRL DRIVEMODE = HIGH

Figure 3.5. Typical Low-Level Output Current, 3.8V Supply Voltage

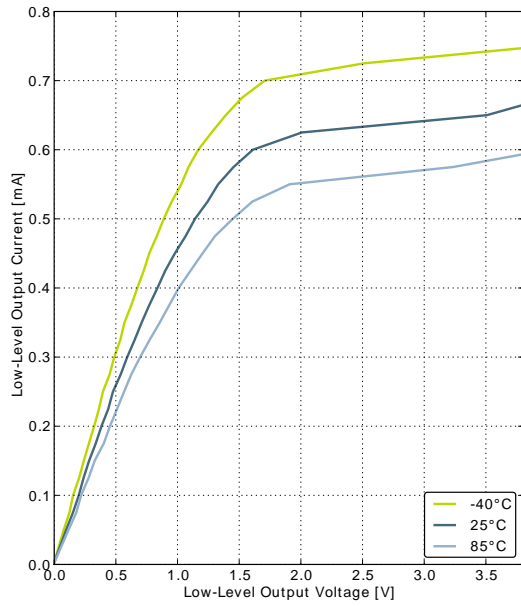

GPIO_Px_CTRL DRIVEMODE = LOWEST

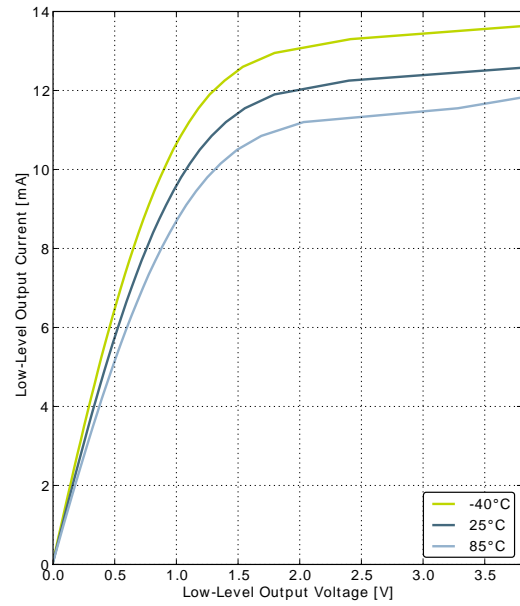

GPIO_Px_CTRL DRIVEMODE = LOW

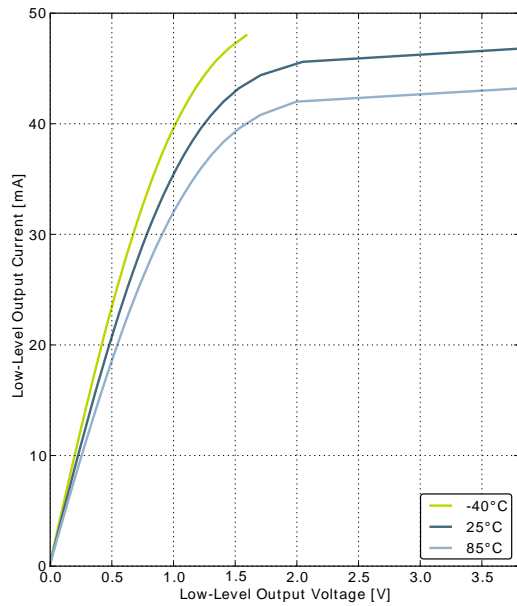

GPIO_Px_CTRL DRIVEMODE = STANDARD

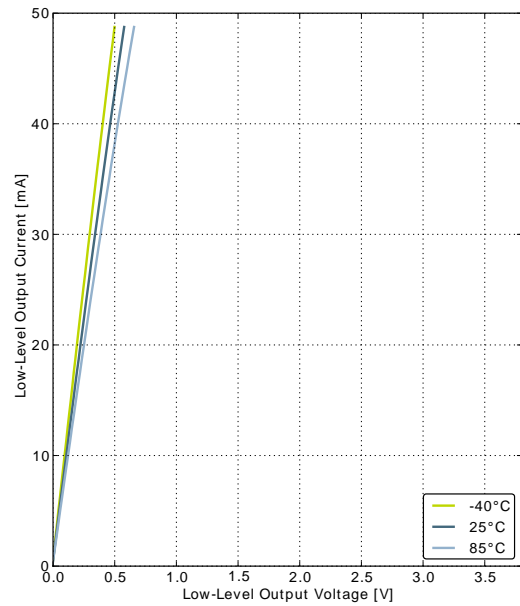

GPIO_Px_CTRL DRIVEMODE = HIGH

Figure 3.6. Typical High-Level Output Current, 3.8V Supply Voltage

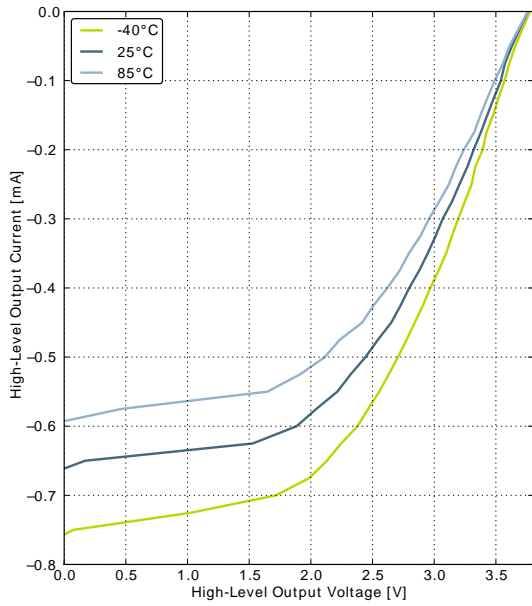

GPIO_Px_CTRL DRIVEMODE = LOWEST

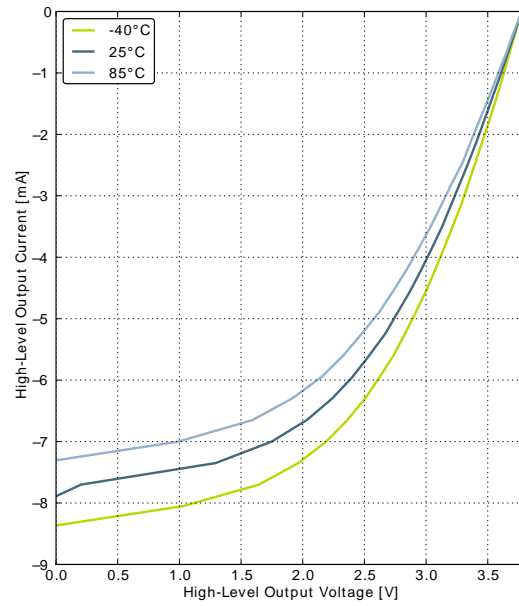

GPIO_Px_CTRL DRIVEMODE = LOW

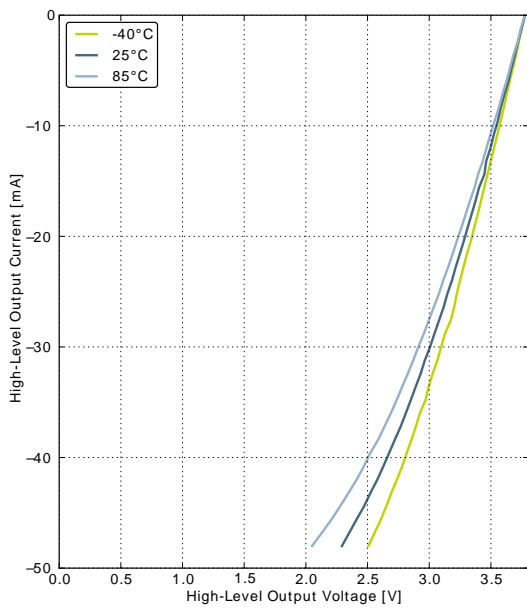

GPIO_Px_CTRL DRIVEMODE = STANDARD

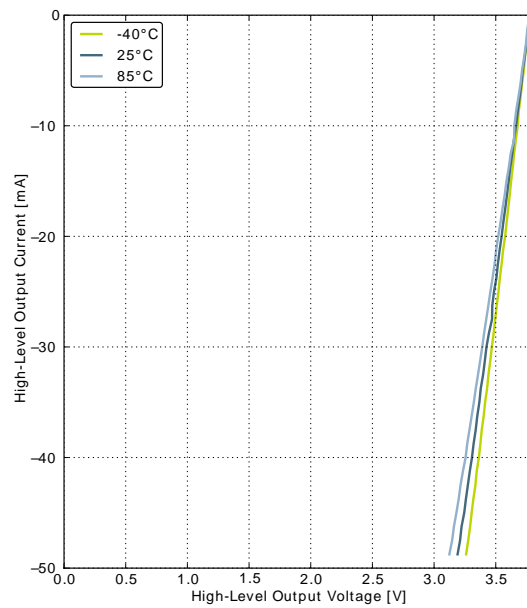

GPIO_Px_CTRL DRIVEMODE = HIGH

3.9 Oscillators

3.9.1 LFXO

Table 3.9. LFXO

Symbol	Parameter	Condition	Min	Typ	Max	Unit
f_{LFXO}	Supported nominal crystal frequency			32.768		kHz
ESR_{LFXO}	Supported crystal equivalent series resistance (ESR)			30	120	kOhm
C_{LFXOL}	Supported crystal external load range		5		25	pF
DC_{LFXO}	Duty cycle		48	50	53.5	%
I_{LFXO}	Current consumption for core and buffer after start-up.	ESR=30 kOhm, $C_L=10$ pF, LFXOBOOST in CMU_CTRL is 1		190		nA
t_{LFXO}	Start-up time.	ESR=30 kOhm, $C_L=10$ pF, 40% - 60% duty cycle has been reached, LFXOBOOST in CMU_CTRL is 1		400		ms

For safe startup of a given crystal, the load capacitance should be larger than the value indicated in Figure 3.7 (p. 22) and in Table 3.10 (p. 23) for a given LFXOBOOST setting. The minimum supported load capacitance depends on the crystal shunt capacitance, C_0 , which is specified in crystal vendors' datasheet.

Figure 3.7. Minimum Load Capacitance (C_{LFXOL}) Requirement For Safe Crystal Startup

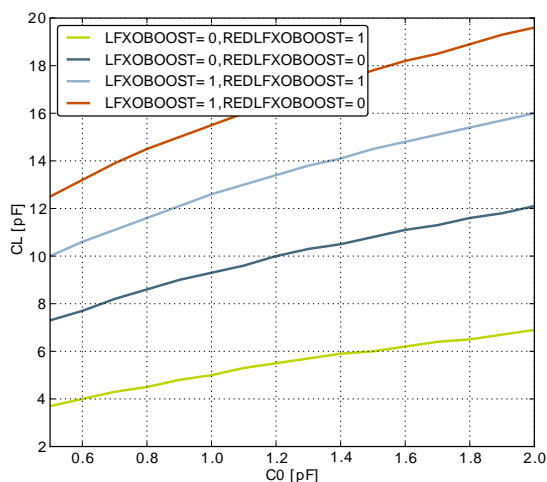

Table 3.10. Minimum Load Capacitance (C_{LFXOL}) Requirement For Safe Crystal Startup

Symbol	Capacitance [pF]															
	0.5	0.6	0.7	0.8	0.9	1.0	1.1	1.2	1.3	1.4	1.5	1.6	1.7	1.8	1.9	2.0
Shunt Capacitance C_0	0.5	0.6	0.7	0.8	0.9	1.0	1.1	1.2	1.3	1.4	1.5	1.6	1.7	1.8	1.9	2.0
CL_{min} lfxoboost = 0 redlfxoboost = 1	3.7	4.0	4.3	4.5	4.8	5.0	5.3	5.5	5.7	5.9	6.0	6.2	6.4	6.5	6.7	6.9
CL_{min} lfxoboost = 1 redlfxoboost = 0	7.3	7.7	8.2	8.6	9.0	9.3	9.6	10.0	10.3	10.5	10.8	11.1	11.3	11.6	11.8	12.1
CL_{min} lfxoboost = 1 redlfxoboost = 1	10.0	10.6	11.1	11.6	12.1	12.6	13.0	13.4	13.8	14.1	14.5	14.8	15.1	15.4	15.7	16.0
CL_{min} lfxoboost = 1 redlfxoboost = 0	12.5	13.2	13.9	14.5	15.0	15.5	16.0	16.5	16.9	17.4	17.8	18.2	18.5	18.9	19.3	19.6

3.9.2 HFXO

Table 3.11. HFXO

Symbol	Parameter	Condition	Min	Typ	Max	Unit
f_{HFXO}	Supported nominal crystal Frequency		4		48	MHz
ESR_{HFXO}	Supported crystal equivalent series resistance (ESR)	Crystal frequency 32 MHz		30	60	Ohm
		Crystal frequency 4 MHz		400	1500	Ohm
g_{mHFXO}	The transconductance of the HFXO input transistor at crystal startup	HFXOBOOST in CMU_CTRL equals 0b11	20			mS
C_{HFXOL}	Supported crystal external load range		5		25	pF
DC_{HFXO}	Duty cycle		46	50	54	%
I_{HFXO}	Current consumption for HFXO after startup	4 MHz: ESR=400 Ohm, $C_L=20$ pF, HFXOBOOST in CMU_CTRL equals 0b11		85		μ A
		32 MHz: ESR=30 Ohm, $C_L=10$ pF, HFXOBOOST in CMU_CTRL equals 0b11		165		μ A
t_{HFXO}	Startup time	32 MHz: ESR=30 Ohm, $C_L=10$ pF, HFXOBOOST in CMU_CTRL equals 0b11		400		μ s

3.9.3 LFRCO

Table 3.12. LFRCO

Symbol	Parameter	Condition	Min	Typ	Max	Unit
f_{LFRCO}	Oscillation frequency , $V_{DD}=3.0$ V, $T_{AMB}=25^\circ$ C			32.768		kHz
t_{LFRCO}	Startup time not including software calibration			150		μ s
I_{LFRCO}	Current consumption			190		nA
$TUNESTEP_{LFRCO}$	Frequency step for LSB change in TUNING value			1.5		%

Figure 3.8. Calibrated LFRCO Frequency vs Temperature and Supply Voltage

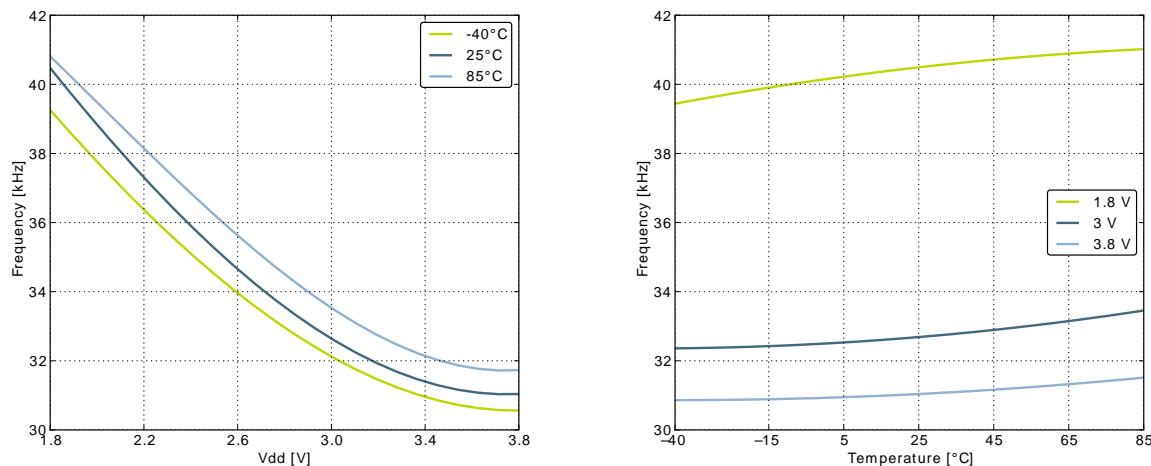

3.9.4 HFRCO

Table 3.13. HFRCO

Symbol	Parameter	Condition	Min	Typ	Max	Unit
f _{HFRCO}	Oscillation frequency, V _{DD} =3.0 V, T _{AMB} =25°C	28 MHz frequency band		28		MHz
		21 MHz frequency band		21		MHz
		14 MHz frequency band		14		MHz
		11 MHz frequency band		11		MHz
		7 MHz frequency band		6.6 ¹		MHz
		1 MHz frequency band		1.2 ²		MHz
t _{HFRCO_settling}	Settling time after start-up	f _{HFRCO} = 14 MHz		0.6		Cycles
I _{HFRCO}	Current consumption	f _{HFRCO} = 28 MHz		106		µA
		f _{HFRCO} = 21 MHz		93		µA
		f _{HFRCO} = 14 MHz		77		µA
		f _{HFRCO} = 11 MHz		72		µA
		f _{HFRCO} = 6.6 MHz		63		µA
		f _{HFRCO} = 1.2 MHz		22		µA
DC _{HFRCO}	Duty cycle	f _{HFRCO} = 14 MHz	48.5	50	51	%
TUNESTEP _{H-FR} FRCO	Frequency step for LSB change in TUNING value			0.3		%

¹7 MHz for devices with prod. rev. < 19.

²1 MHz for devices with prod. rev. < 19.

Figure 3.9. Calibrated HFRCO 11 MHz Band Frequency vs Temperature and Supply Voltage

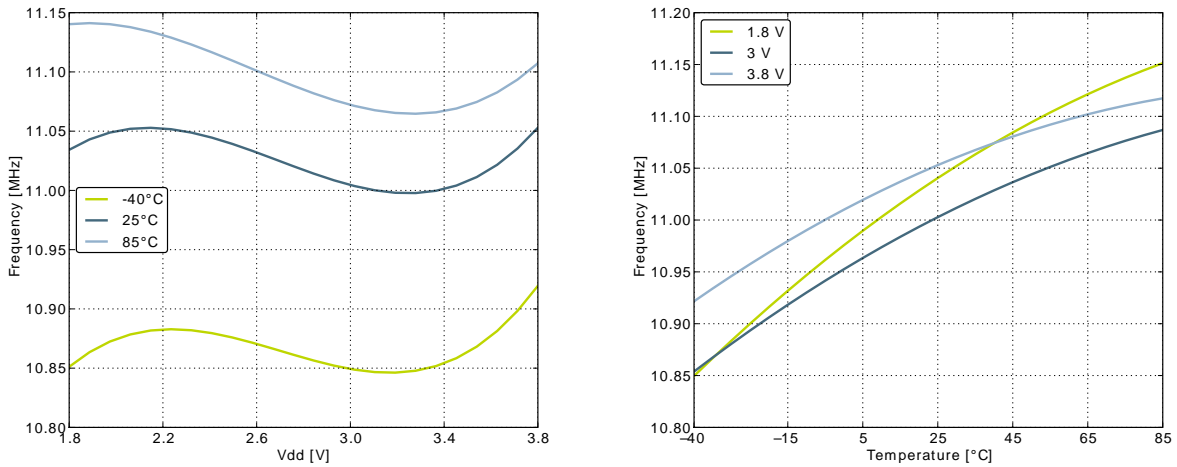

Figure 3.10. Calibrated HFRCO 14 MHz Band Frequency vs Temperature and Supply Voltage

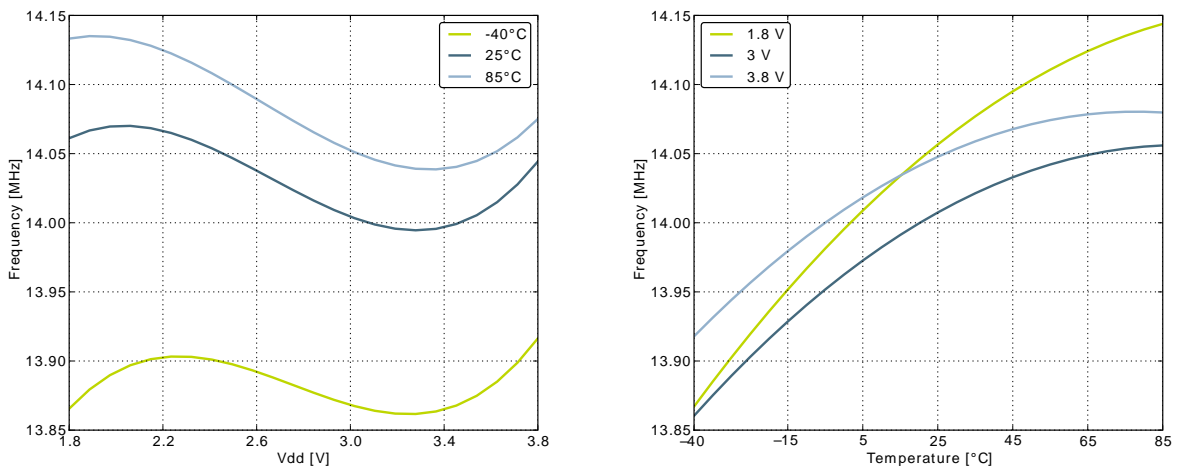

Figure 3.11. Calibrated HFRCO 21 MHz Band Frequency vs Temperature and Supply Voltage

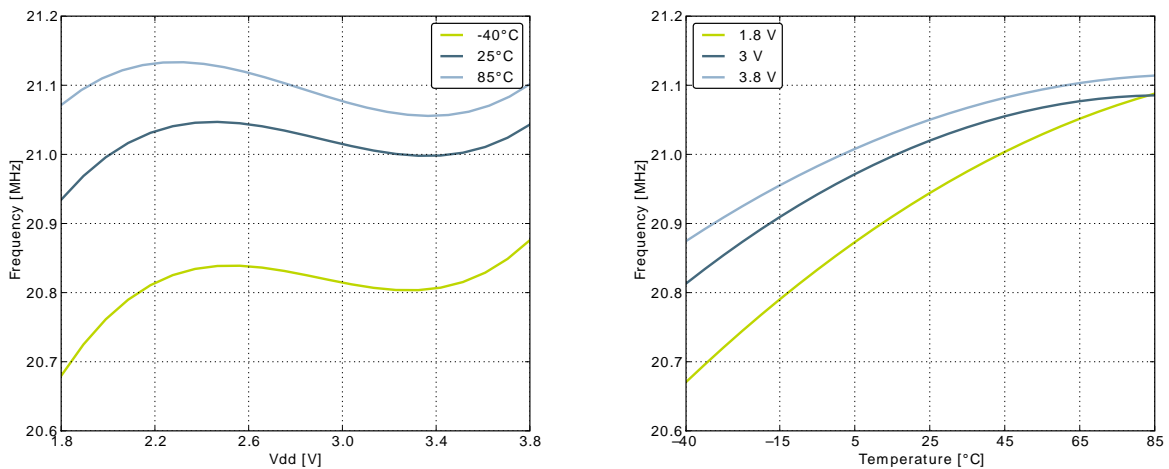
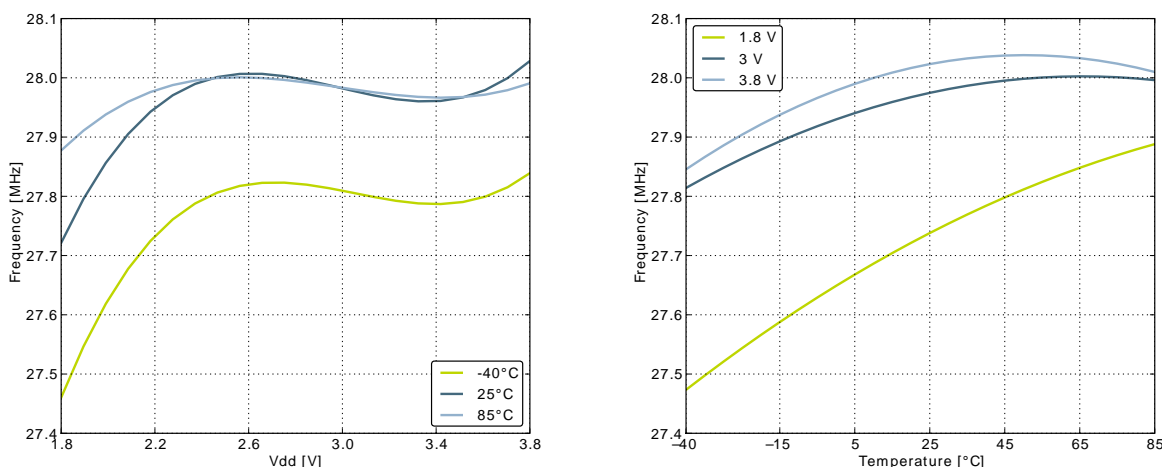

Figure 3.12. Calibrated HFRCO 28 MHz Band Frequency vs Temperature and Supply Voltage



3.9.5 ULFRCO

Table 3.14. ULFRCO

Symbol	Parameter	Condition	Min	Typ	Max	Unit
f _{ULFRCO}	Oscillation frequency	25°C, 3V	0.8		1.5	kHz
TC _{ULFRCO}	Temperature coefficient			0.05		%/°C
VC _{ULFRCO}	Supply voltage coefficient			-18.2		%/V

3.10 Analog Digital Converter (ADC)

Table 3.15. ADC

Symbol	Parameter	Condition	Min	Typ	Max	Unit
V _{ADCIN}	Input voltage range	Single ended	0		V _{REF}	V
		Differential	-V _{REF} /2		V _{REF} /2	V
V _{ADCREFIN}	Input range of external reference voltage, single ended and differential		1.25		V _{DD}	V
V _{ADCREFIN_CH7}	Input range of external negative reference voltage on channel 7	See V _{ADCREFIN}	0		V _{DD} - 1.1	V
V _{ADCREFIN_CH6}	Input range of external positive reference voltage on channel 6	See V _{ADCREFIN}	0.625		V _{DD}	V
V _{ADCCMIN}	Common mode input range		0		V _{DD}	V
I _{ADCIN}	Input current	2pF sampling capacitors		<100		nA
CMRR _{ADC}	Analog input common mode rejection ratio			65		dB
I _{ADC}	Average active current	1 MSamples/s, 12 bit, external reference		351		μA
		10 kSamples/s 12 bit, internal 1.25 V reference, WARMUP-		67		μA

Symbol	Parameter	Condition	Min	Typ	Max	Unit
		MODE in ADCn_CTRL set to 0b00				
		10 kSamples/s 12 bit, internal 1.25 V reference, WARMUP-MODE in ADCn_CTRL set to 0b01		63		μA
		10 kSamples/s 12 bit, internal 1.25 V reference, WARMUP-MODE in ADCn_CTRL set to 0b10		64		μA
I _{ADCREF}	Current consumption of internal voltage reference	Internal voltage reference		65		μA
C _{ADCIN}	Input capacitance			2		pF
R _{ADCIN}	Input ON resistance		1			MOhm
R _{ADCFILT}	Input RC filter resistance			10		kOhm
C _{ADCFILT}	Input RC filter/decoupling capacitance			250		fF
f _{ADCCLK}	ADC Clock Frequency				13	MHz
t _{ADCCONV}	Conversion time	6 bit		7		ADC-CLK Cycles
		10 bit		11		ADC-CLK Cycles
		12 bit		13		ADC-CLK Cycles
t _{ADCACQ}	Acquisition time	Programmable	1		256	ADC-CLK Cycles
t _{ADCACQVDD3}	Required acquisition time for VDD/3 reference		2			μs
t _{ADCSTART}	Startup time of reference generator and ADC core in NORMAL mode			5		μs
	Startup time of reference generator and ADC core in KEEPADCWARM mode			1		μs
SNR _{ADC}	Signal to Noise Ratio (SNR)	1 MSamples/s, 12 bit, single ended, internal 1.25V reference		59		dB
		1 MSamples/s, 12 bit, single ended, internal 2.5V reference		63		dB
		1 MSamples/s, 12 bit, single ended, V _{DD} reference		65		dB
		1 MSamples/s, 12 bit, differential, internal 1.25V reference		60		dB
		1 MSamples/s, 12 bit, differential, internal 2.5V reference		65		dB

Symbol	Parameter	Condition	Min	Typ	Max	Unit
		1 MSamples/s, 12 bit, differential, 5V reference		54		dB
		1 MSamples/s, 12 bit, differential, V _{DD} reference		67		dB
		1 MSamples/s, 12 bit, differential, 2xV _{DD} reference		69		dB
		200 kSamples/s, 12 bit, single ended, internal 1.25V reference		62		dB
		200 kSamples/s, 12 bit, single ended, internal 2.5V reference		63		dB
		200 kSamples/s, 12 bit, single ended, V _{DD} reference		67		dB
		200 kSamples/s, 12 bit, differential, internal 1.25V reference		63		dB
		200 kSamples/s, 12 bit, differential, internal 2.5V reference		66		dB
		200 kSamples/s, 12 bit, differential, 5V reference		66		dB
		200 kSamples/s, 12 bit, differential, V _{DD} reference		69		dB
		200 kSamples/s, 12 bit, differential, 2xV _{DD} reference		70		dB
		SNDR _{ADC}	Signal to Noise-puls-Distortion Ratio (SNDR)	1 MSamples/s, 12 bit, single ended, internal 1.25V reference		58
1 MSamples/s, 12 bit, single ended, internal 2.5V reference				62		dB
1 MSamples/s, 12 bit, single ended, V _{DD} reference				64		dB
1 MSamples/s, 12 bit, differential, internal 1.25V reference				60		dB
1 MSamples/s, 12 bit, differential, internal 2.5V reference				64		dB
1 MSamples/s, 12 bit, differential, 5V reference				54		dB
1 MSamples/s, 12 bit, differential, V _{DD} reference				66		dB
1 MSamples/s, 12 bit, differential, 2xV _{DD} reference				68		dB
200 kSamples/s, 12 bit, single ended, internal 1.25V reference				61		dB
200 kSamples/s, 12 bit, single ended, internal 2.5V reference				65		dB

Symbol	Parameter	Condition	Min	Typ	Max	Unit
SFDR _{ADC}	Spurious-Free Dynamic Range (SFDR)	200 kSamples/s, 12 bit, single ended, V _{DD} reference		66		dB
		200 kSamples/s, 12 bit, differential, internal 1.25V reference		63		dB
		200 kSamples/s, 12 bit, differential, internal 2.5V reference		66		dB
		200 kSamples/s, 12 bit, differential, 5V reference		66		dB
		200 kSamples/s, 12 bit, differential, V _{DD} reference		68		dB
		200 kSamples/s, 12 bit, differential, 2xV _{DD} reference		69		dB
		1 MSamples/s, 12 bit, single ended, internal 1.25V reference		64		dBc
		1 MSamples/s, 12 bit, single ended, internal 2.5V reference		76		dBc
		1 MSamples/s, 12 bit, single ended, V _{DD} reference		73		dBc
		1 MSamples/s, 12 bit, differential, internal 1.25V reference		66		dBc
		1 MSamples/s, 12 bit, differential, internal 2.5V reference		77		dBc
		1 MSamples/s, 12 bit, differential, V _{DD} reference		76		dBc
		1 MSamples/s, 12 bit, differential, 2xV _{DD} reference		75		dBc
		1 MSamples/s, 12 bit, differential, 5V reference		69		dBc
		200 kSamples/s, 12 bit, single ended, internal 1.25V reference		75		dBc
		200 kSamples/s, 12 bit, single ended, internal 2.5V reference		75		dBc
		200 kSamples/s, 12 bit, single ended, V _{DD} reference		76		dBc
		200 kSamples/s, 12 bit, differential, internal 1.25V reference		79		dBc
		200 kSamples/s, 12 bit, differential, internal 2.5V reference		79		dBc
200 kSamples/s, 12 bit, differential, 5V reference		78		dBc		
200 kSamples/s, 12 bit, differential, V _{DD} reference		79		dBc		

Symbol	Parameter	Condition	Min	Typ	Max	Unit
		200 kSamples/s, 12 bit, differential, 2xV _{DD} reference		79		dBc
V _{ADCOFFSET}	Offset voltage	After calibration, single ended		0.3		mV
		After calibration, differential		0.3		mV
TGRAD _{ADCTH}	Thermometer output gradient			-1.92		mV/°C
				-6.3		ADC Codes/°C
DNL _{ADC}	Differential non-linearity (DNL)			±0.7		LSB
INL _{ADC}	Integral non-linearity (INL), End point method			±1.2		LSB
MC _{ADC}	No missing codes		11.999 ¹	12		bits
GAIN _{ED}	Gain error drift	1.25V reference		0.01 ²	0.033 ³	%/°C
		2.5V reference		0.01 ²	0.03 ³	%/°C
OFFSET _{ED}	Offset error drift	1.25V reference		0.2 ²	0.7 ³	LSB/°C
		2.5V reference		0.2 ²	0.62 ³	LSB/°C

¹On the average every ADC will have one missing code, most likely to appear around 2048 +/- n*512 where n can be a value in the set {-3, -2, -1, 1, 2, 3}. There will be no missing code around 2048, and in spite of the missing code the ADC will be monotonic at all times so that a response to a slowly increasing input will always be a slowly increasing output. Around the one code that is missing, the neighbour codes will look wider in the DNL plot. The spectra will show spurs on the level of -78dBc for a full scale input for chips that have the missing code issue.

²Typical numbers given by abs(Mean) / (85 - 25).

³Max number given by (abs(Mean) + 3x stddev) / (85 - 25).

The integral non-linearity (INL) and differential non-linearity parameters are explained in Figure 3.13 (p. 30) and Figure 3.14 (p. 31) , respectively.

Figure 3.13. Integral Non-Linearity (INL)

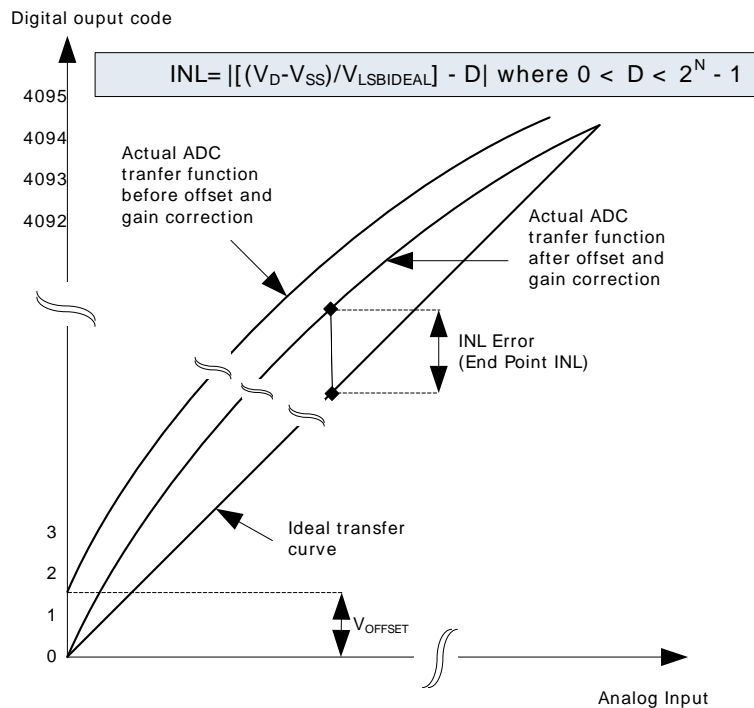
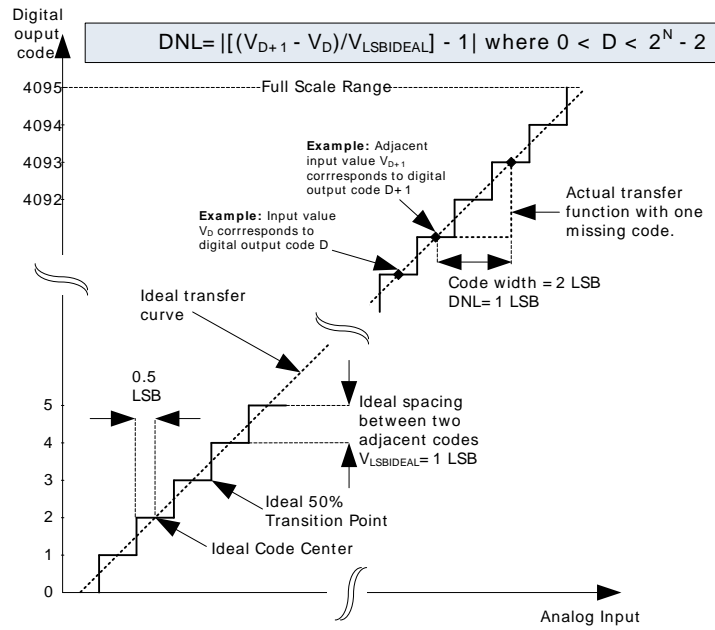
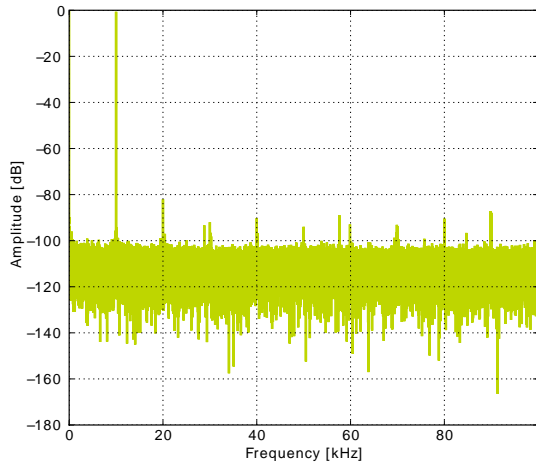

Figure 3.14. Differential Non-Linearity (DNL)



3.10.1 Typical performance

Figure 3.15. ADC Frequency Spectrum, Vdd = 3V, Temp = 25°



1.25V Reference

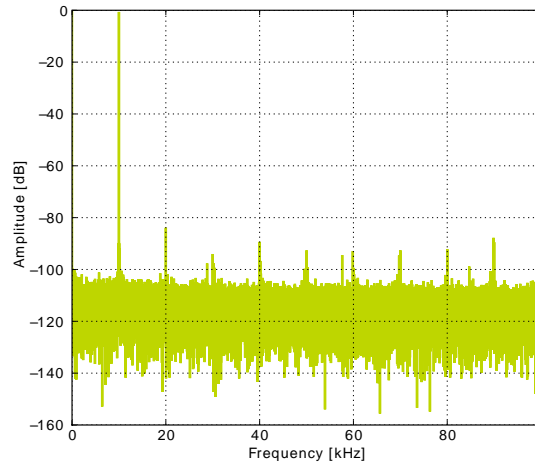

2.5V Reference

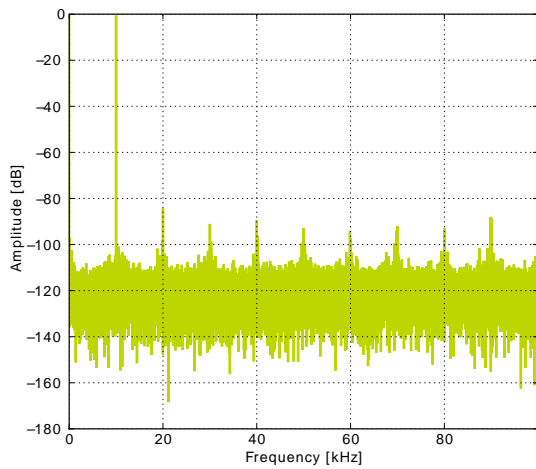

2XVDDVSS Reference

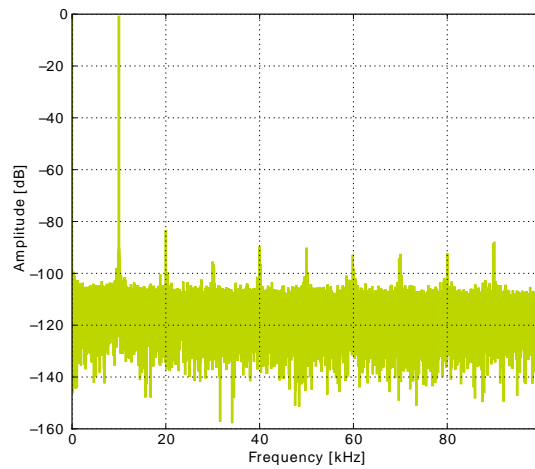

5VDIFF Reference

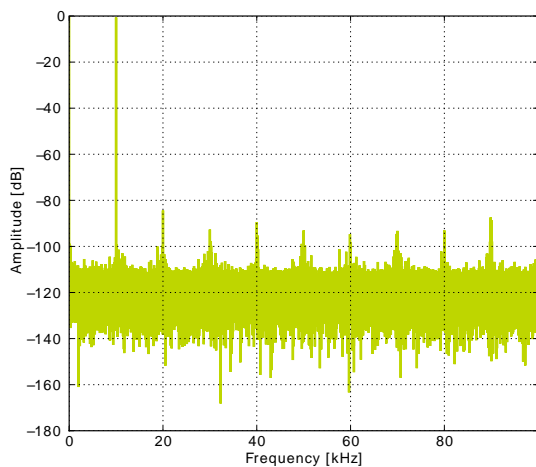

VDD Reference

Figure 3.16. ADC Integral Linearity Error vs Code, Vdd = 3V, Temp = 25°

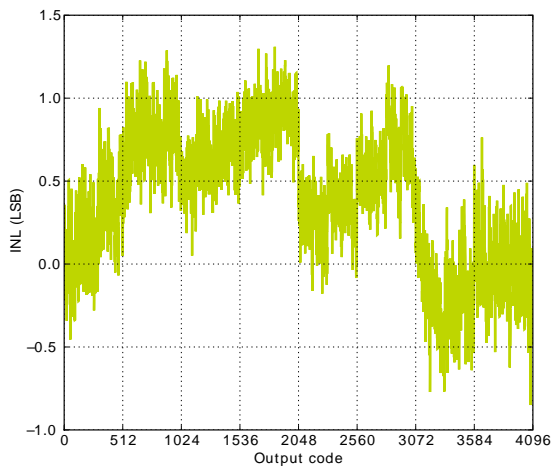

1.25V Reference

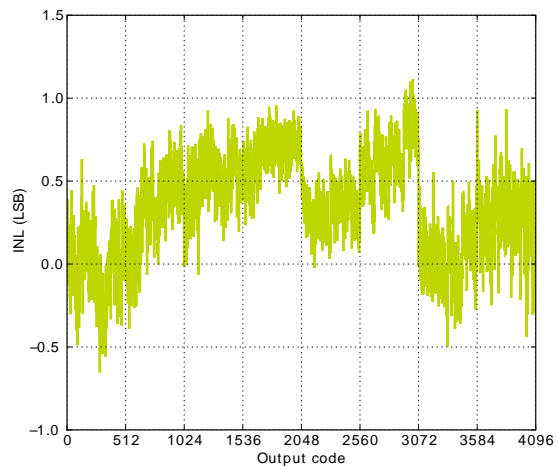

2.5V Reference

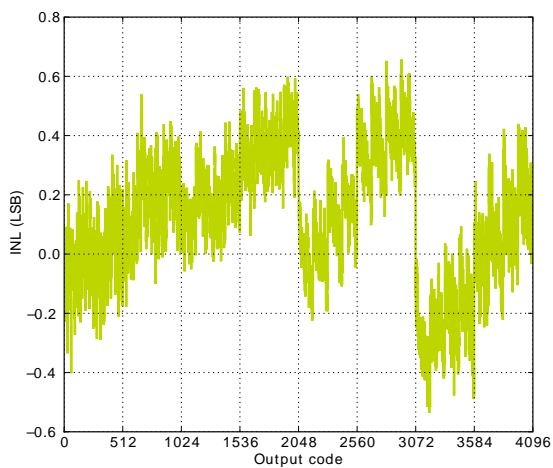

2XVDDVSS Reference

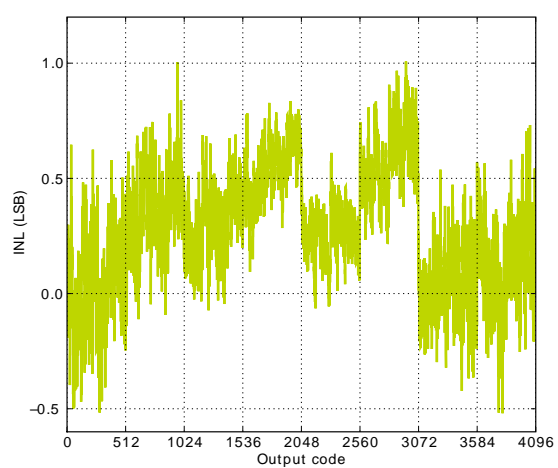

5VDIFF Reference

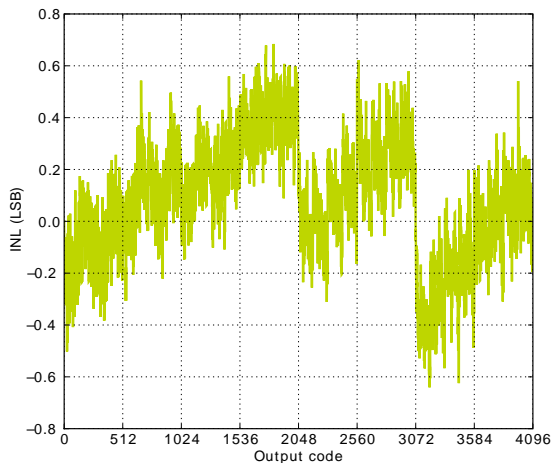

VDD Reference

Figure 3.17. ADC Differential Linearity Error vs Code, V_{dd} = 3V, Temp = 25°

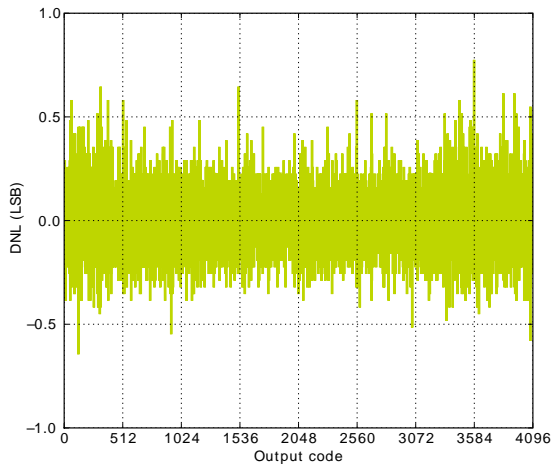

1.25V Reference

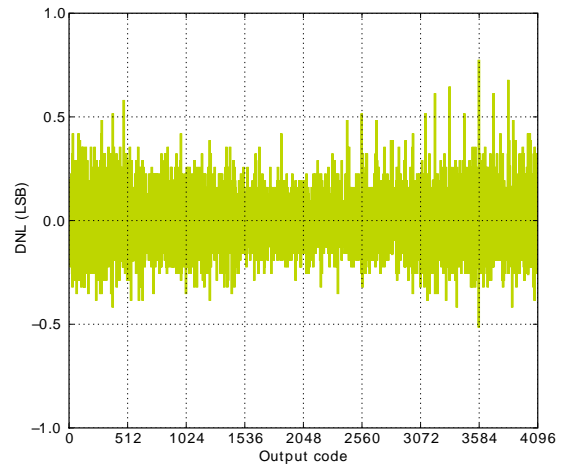

2.5V Reference

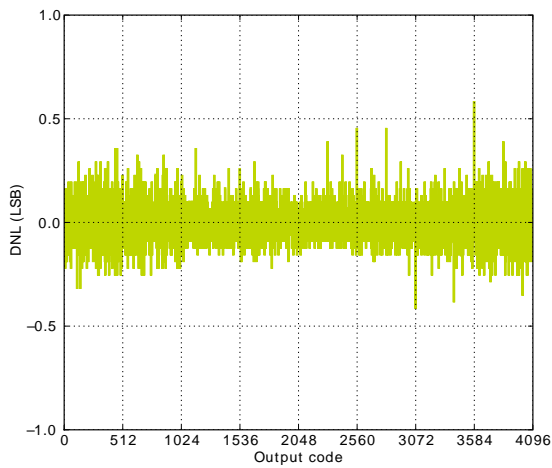

2XVDDVSS Reference

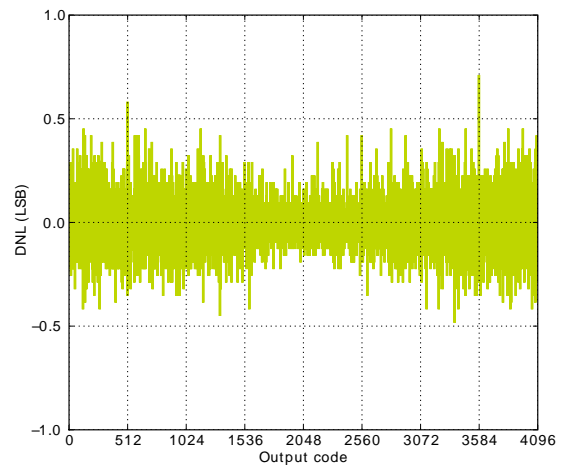

5VDIFF Reference

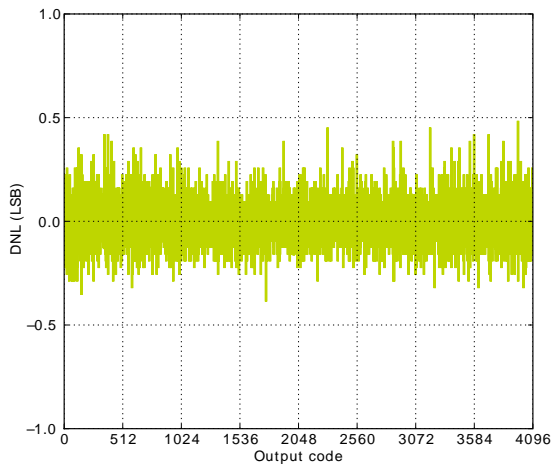

VDD Reference

Figure 3.18. ADC Absolute Offset, Common Mode = $V_{dd}/2$

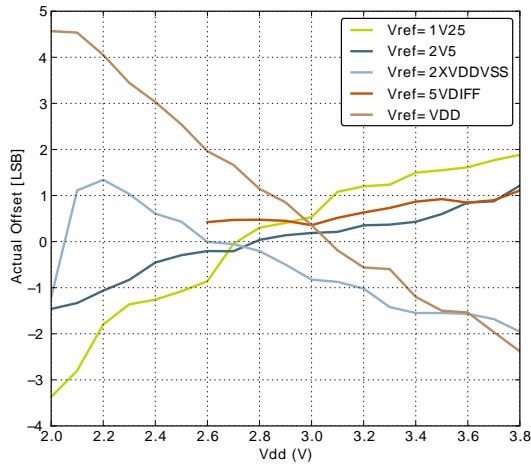

Offset vs Supply Voltage, Temp = 25°

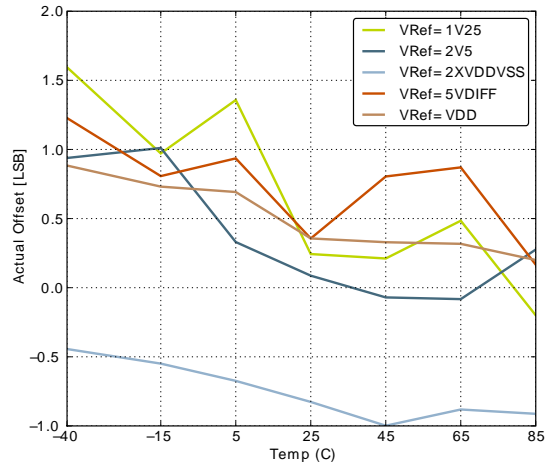

Offset vs Temperature, Vdd = 3V

Figure 3.19. ADC Dynamic Performance vs Temperature for all ADC References, Vdd = 3V

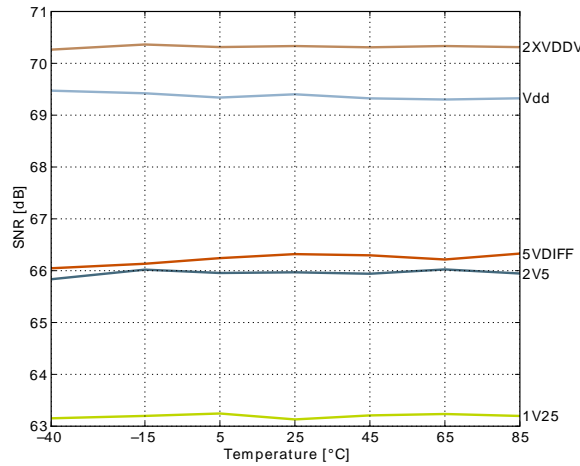

Signal to Noise Ratio (SNR)

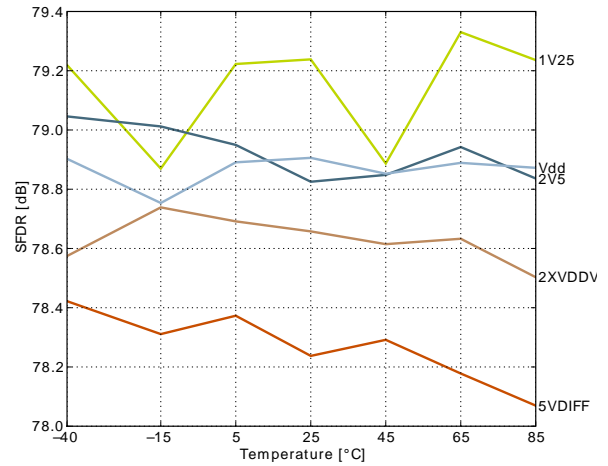

Spurious-Free Dynamic Range (SFDR)

Figure 3.20. ADC Temperature sensor readout

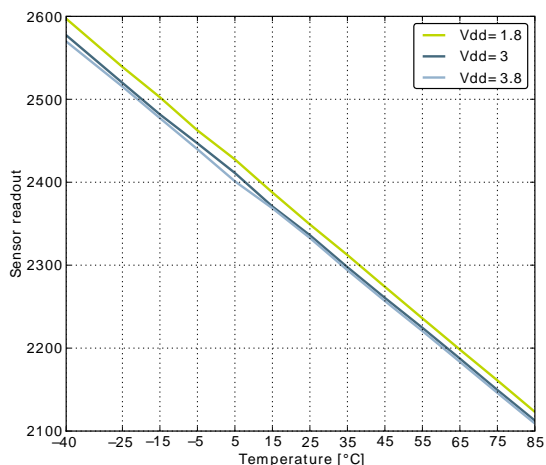

3.11 Digital Analog Converter (DAC)

Table 3.16. DAC

Symbol	Parameter	Condition	Min	Typ	Max	Unit
V _{DACOUT}	Output voltage range	VDD voltage reference, single ended	0		V _{DD}	V
		VDD voltage reference, differential	-V _{DD}		V _{DD}	V
V _{DACCM}	Output common mode voltage range		0		V _{DD}	V
I _{DAC}	Active current including references for 2 channels	500 kSamples/s, 12 bit		400		μA
		100 kSamples/s, 12 bit		200		μA
		1 kSamples/s 12 bit NORMAL		38		μA
SR _{DAC}	Sample rate				500	ksamples/s
f _{DAC}	DAC clock frequency	Continuous Mode			1000	kHz
		Sample/Hold Mode			250	kHz
		Sample/Off Mode			250	kHz
CYC _{DACCONV}	Clock cycles per conversion			2		
t _{DACCONV}	Conversion time		2			μs
t _{DACSETTLE}	Settling time			5		μs
SNR _{DAC}	Signal to Noise Ratio (SNR)	500 kSamples/s, 12 bit, single ended, internal 1.25V reference		58		dB
		500 kSamples/s, 12 bit, single ended, internal 2.5V reference		59		dB
		500 kSamples/s, 12 bit, differential, internal 1.25V reference		58		dB

Symbol	Parameter	Condition	Min	Typ	Max	Unit
		500 kSamples/s, 12 bit, differential, internal 2.5V reference		58		dB
		500 kSamples/s, 12 bit, differential, V _{DD} reference		59		dB
SNDR _{DAC}	Signal to Noise-pulse Distortion Ratio (SNDR)	500 kSamples/s, 12 bit, single ended, internal 1.25V reference		57		dB
		500 kSamples/s, 12 bit, single ended, internal 2.5V reference		54		dB
		500 kSamples/s, 12 bit, differential, internal 1.25V reference		56		dB
		500 kSamples/s, 12 bit, differential, internal 2.5V reference		53		dB
		500 kSamples/s, 12 bit, differential, V _{DD} reference		55		dB
SFDR _{DAC}	Spurious-Free Dynamic Range(SFDR)	500 kSamples/s, 12 bit, single ended, internal 1.25V reference		62		dBc
		500 kSamples/s, 12 bit, single ended, internal 2.5V reference		56		dBc
		500 kSamples/s, 12 bit, differential, internal 1.25V reference		61		dBc
		500 kSamples/s, 12 bit, differential, internal 2.5V reference		55		dBc
		500 kSamples/s, 12 bit, differential, V _{DD} reference		60		dBc
V _{DACOFFSET}	Offset voltage	After calibration, single ended		2		mV
		After calibration, differential		2		mV
DNL _{DAC}	Differential non-linearity			±1		LSB
INL _{DAC}	Integral non-linearity			±5		LSB
MC _{DAC}	No missing codes			12		bits

3.12 Operational Amplifier (OPAMP)

The electrical characteristics for the Operational Amplifiers are based on simulations.

Table 3.17. OPAMP

Symbol	Parameter	Condition	Min	Typ	Max	Unit
I _{OPAMP}	Active Current	(OPA2)BIASPROG=0xF, (OPA2)HALFBIAS=0x0, Unity Gain		400		μA
		(OPA2)BIASPROG=0x7, (OPA2)HALFBIAS=0x1, Unity Gain		100		μA

Symbol	Parameter	Condition	Min	Typ	Max	Unit
		(OPA2)BIASPROG=0x0, (OPA2)HALFBIAS=0x1, Unity Gain		13		μA
G _{OL}	Open Loop Gain	(OPA2)BIASPROG=0xF, (OPA2)HALFBIAS=0x0		101		dB
		(OPA2)BIASPROG=0x7, (OPA2)HALFBIAS=0x1		98		dB
		(OPA2)BIASPROG=0x0, (OPA2)HALFBIAS=0x1		91		dB
GBW _{OPAMP}	Gain Bandwidth Product	(OPA2)BIASPROG=0xF, (OPA2)HALFBIAS=0x0		6.1		MHz
		(OPA2)BIASPROG=0x7, (OPA2)HALFBIAS=0x1		1.8		MHz
		(OPA2)BIASPROG=0x0, (OPA2)HALFBIAS=0x1		0.25		MHz
PM _{OPAMP}	Phase Margin	(OPA2)BIASPROG=0xF, (OPA2)HALFBIAS=0x0, C _L =75 pF		64		°
		(OPA2)BIASPROG=0x7, (OPA2)HALFBIAS=0x1, C _L =75 pF		58		°
		(OPA2)BIASPROG=0x0, (OPA2)HALFBIAS=0x1, C _L =75 pF		58		°
R _{INPUT}	Input Resistance			100		Mohm
R _{LOAD}	Load Resistance		200			Ohm
I _{LOAD_DC}	DC Load Current				11	mA
V _{INPUT}	Input Voltage	OPA _x HCMDIS=0	V _{SS}		V _{DD}	V
		OPA _x HCMDIS=1	V _{SS}		V _{DD} -1.2	V
V _{OUTPUT}	Output Voltage		V _{SS}		V _{DD}	V
V _{OFFSET}	Input Offset Voltage	Unity Gain, V _{SS} <V _{in} <V _{DD} , OPA _x HCMDIS=0		6		mV
		Unity Gain, V _{SS} <V _{in} <V _{DD} -1.2, OPA _x HCMDIS=1		1		mV
V _{OFFSET_DRIFT}	Input Offset Voltage Drift				0.02	mV/°C
SR _{OPAMP}	Slew Rate	(OPA2)BIASPROG=0xF, (OPA2)HALFBIAS=0x0		3.2		V/μs
		(OPA2)BIASPROG=0x7, (OPA2)HALFBIAS=0x1		0.8		V/μs
		(OPA2)BIASPROG=0x0, (OPA2)HALFBIAS=0x1		0.1		V/μs
N _{OPAMP}	Voltage Noise	V _{out} =1V, RESSEL=0, 0.1 Hz<f<10 kHz, OPA _x - HCMDIS=0		101		μV _{RMS}
		V _{out} =1V, RESSEL=0, 0.1 Hz<f<10 kHz, OPA _x - HCMDIS=1		141		μV _{RMS}

Symbol	Parameter	Condition	Min	Typ	Max	Unit
		$V_{out}=1V$, RESSEL=0, $0.1\text{ Hz}<f<1\text{ MHz}$, OPAX-HCMDIS=0		196		μV_{RMS}
		$V_{out}=1V$, RESSEL=0, $0.1\text{ Hz}<f<1\text{ MHz}$, OPAX-HCMDIS=1		229		μV_{RMS}
		RESSEL=7, $0.1\text{ Hz}<f<10\text{ kHz}$, OPAXHCMDIS=0		1230		μV_{RMS}
		RESSEL=7, $0.1\text{ Hz}<f<10\text{ kHz}$, OPAXHCMDIS=1		2130		μV_{RMS}
		RESSEL=7, $0.1\text{ Hz}<f<1\text{ MHz}$, OPAXHCMDIS=0		1630		μV_{RMS}
		RESSEL=7, $0.1\text{ Hz}<f<1\text{ MHz}$, OPAXHCMDIS=1		2590		μV_{RMS}

Figure 3.21. OPAMP Common Mode Rejection Ratio

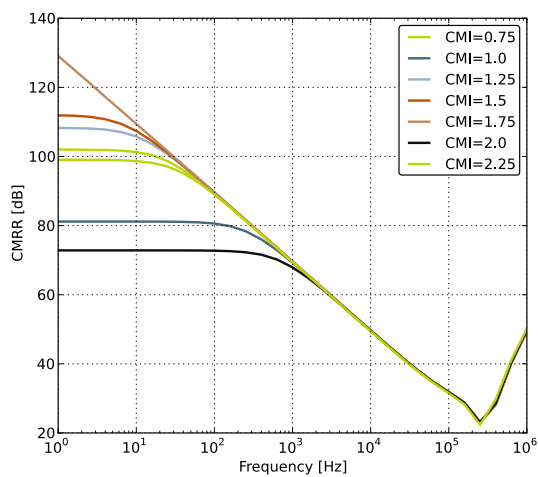

Figure 3.22. OPAMP Positive Power Supply Rejection Ratio

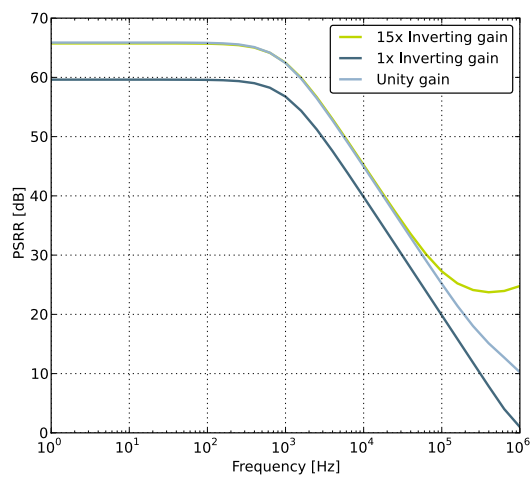

Figure 3.23. OPAMP Negative Power Supply Rejection Ratio

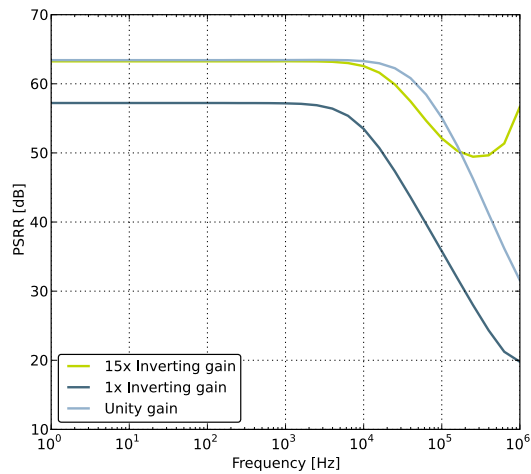

Figure 3.24. OPAMP Voltage Noise Spectral Density (Unity Gain) $V_{out}=1V$

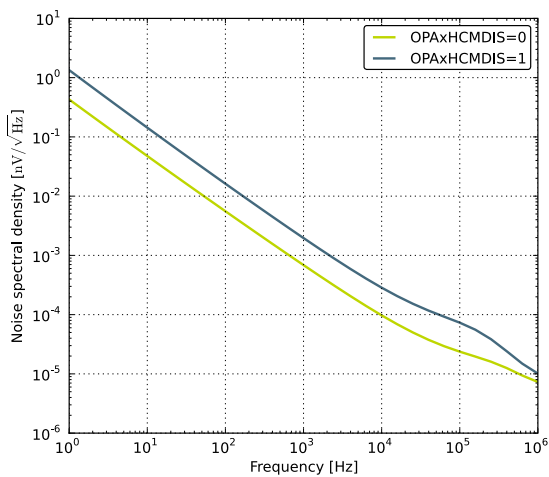
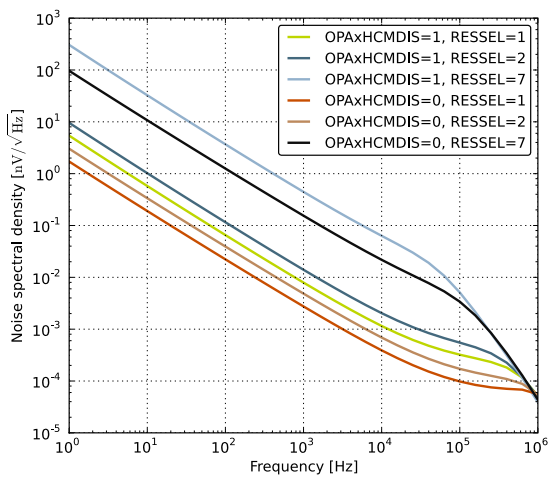

Figure 3.25. OPAMP Voltage Noise Spectral Density (Non-Unity Gain)



3.13 Analog Comparator (ACMP)

Table 3.18. ACMP

Symbol	Parameter	Condition	Min	Typ	Max	Unit
V_{ACMPIN}	Input voltage range		0		V_{DD}	V
V_{ACMPCM}	ACMP Common Mode voltage range		0		V_{DD}	V
I_{ACMP}	Active current	BIASPROG=0b0000, FULL-BIAS=0 and HALFBIAS=1 in ACMPn_CTRL register		0.1		μ A
		BIASPROG=0b1111, FULL-BIAS=0 and HALFBIAS=0 in ACMPn_CTRL register		2.87		μ A
		BIASPROG=0b1111, FULL-BIAS=1 and HALFBIAS=0 in ACMPn_CTRL register		195		μ A
$I_{ACMPREF}$	Current consumption of internal voltage reference	Internal voltage reference off. Using external voltage reference		0		μ A
		Internal voltage reference		5		μ A
$V_{ACMPOFFSET}$	Offset voltage	Single ended		10		mV
		Differential		10		mV
$V_{ACMPHYST}$	ACMP hysteresis	Programmable		17		mV
R_{CSRES}	Capacitive Sense Internal Resistance	CSRESSEL=0b00 in ACMPn_INPUTSEL		39		kOhm
		CSRESSEL=0b01 in ACMPn_INPUTSEL		71		kOhm
		CSRESSEL=0b10 in ACMPn_INPUTSEL		104		kOhm
		CSRESSEL=0b11 in ACMPn_INPUTSEL		136		kOhm

The total ACMP current is the sum of the contributions from the ACMP and its internal voltage reference as given in Equation 3.1 (p. 41) . $I_{ACMPREF}$ is zero if an external voltage reference is used.

Total ACMP Active Current

$$I_{ACMPTOTAL} = I_{ACMP} + I_{ACMPREF} \quad (3.1)$$

Figure 3.26. Typical ACMP Characteristics

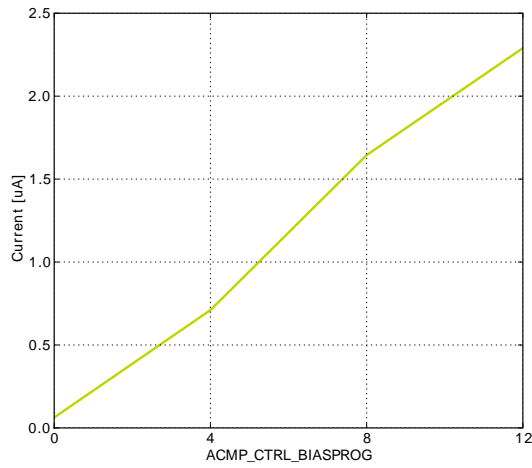

Current consumption

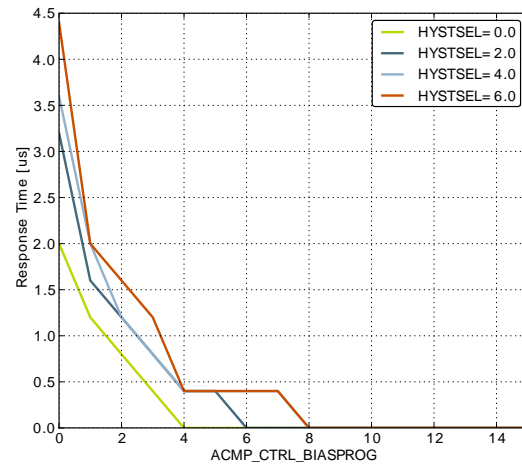

Response time

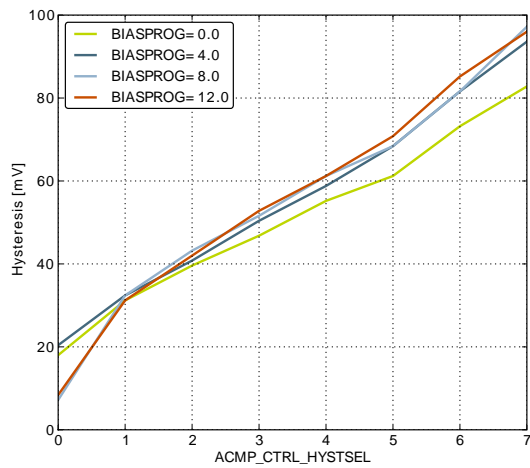

Hysteresis

3.14 Voltage Comparator (VCMP)

Table 3.19. VCMP

Symbol	Parameter	Condition	Min	Typ	Max	Unit
V _{VCMPIN}	Input voltage range			V _{DD}		V
V _{VCMP_{CM}}	VCMP Common Mode voltage range			V _{DD}		V
I _{VCMP}	Active current	BIASPROG=0b0000 and HALFBIAS=1 in VCMPn_CTRL register		0.1		μA
		BIASPROG=0b1111 and HALFBIAS=0 in VCMPn_CTRL register. LPREF=0.		14.7		μA
t _{VCMPREF}	Startup time reference generator	NORMAL		10		μs
V _{VCMP_{OFFSET}}	Offset voltage	Single ended		10		mV
		Differential		10		mV
V _{VCMP_{HYST}}	VCMP hysteresis			17		mV

The V_{DD} trigger level can be configured by setting the TRIGLEVEL field of the VCMP_CTRL register in accordance with the following equation:

VCMP Trigger Level as a Function of Level Setting

$$V_{DD \text{ Trigger Level}} = 1.667V + 0.034 \times \text{TRIGLEVEL} \quad (3.2)$$

3.15 LCD

Table 3.20. LCD

Symbol	Parameter	Condition	Min	Typ	Max	Unit
f _{LCDFR}	Frame rate		30		200	Hz
NUM _{SEG}	Number of segments supported			36x8		seg
V _{LCD}	LCD supply voltage range	Internal boost circuit enabled	2.0		3.8	V
I _{LCD}	Steady state current consumption.	Display disconnected, static mode, framerate 32 Hz, all segments on.		250		nA
		Display disconnected, quadruplex mode, framerate 32 Hz, all segments on, bias mode to ONETHIRD in LCD_DISPCTRL register.		550		nA
I _{LCDBOOST}	Steady state Current contribution of internal boost.	Internal voltage boost off		0		μA
		Internal voltage boost on, boosting from 2.2 V to 3.0 V.		8.4		μA
V _{BOOST}	Boost Voltage	VBLEV of LCD_DISPCTRL register to LEVEL0		3.0		V
		VBLEV of LCD_DISPCTRL register to LEVEL1		3.08		V
		VBLEV of LCD_DISPCTRL register to LEVEL2		3.17		V
		VBLEV of LCD_DISPCTRL register to LEVEL3		3.26		V
		VBLEV of LCD_DISPCTRL register to LEVEL4		3.34		V
		VBLEV of LCD_DISPCTRL register to LEVEL5		3.43		V
		VBLEV of LCD_DISPCTRL register to LEVEL6		3.52		V
		VBLEV of LCD_DISPCTRL register to LEVEL7		3.6		V

The total LCD current is given by Equation 3.3 (p. 44) . $I_{LCDBOOST}$ is zero if internal boost is off.

Total LCD Current Based on Operational Mode and Internal Boost

$$I_{LCDTOTAL} = I_{LCD} + I_{LCDBOOST} \quad (3.3)$$

3.16 Digital Peripherals

Table 3.21. Digital Peripherals

Symbol	Parameter	Condition	Min	Typ	Max	Unit
I _{USART}	USART current	USART idle current, clock enabled		7.5		μA/ MHz
I _{UART}	UART current	UART idle current, clock enabled		5.63		μA/ MHz

Symbol	Parameter	Condition	Min	Typ	Max	Unit
I _{LEUART}	LEUART current	LEUART idle current, clock enabled		150		nA
I _{I2C}	I2C current	I2C idle current, clock enabled		6.25		μA/ MHz
I _{TIMER}	TIMER current	TIMER_0 idle current, clock enabled		8.75		μA/ MHz
I _{LETIMER}	LETIMER current	LETIMER idle current, clock enabled		150		nA
I _{PCNT}	PCNT current	PCNT idle current, clock enabled		100		nA
I _{RTC}	RTC current	RTC idle current, clock enabled		100		nA
I _{LCD}	LCD current	LCD idle current, clock enabled		100		nA
I _{AES}	AES current	AES idle current, clock enabled		2.5		μA/ MHz
I _{GPIO}	GPIO current	GPIO idle current, clock enabled		5.31		μA/ MHz
I _{EBI}	EBI current	EBI idle current, clock enabled		1.56		μA/ MHz
I _{PRS}	PRS current	PRS idle current		2,81		μA/ MHz
I _{DMA}	DMA current	Clock enable		8.12		μA/ MHz

4 Pinout and Package

Note

Please refer to the application note "AN0002 EFM32 Hardware Design Considerations" for guidelines on designing Printed Circuit Boards (PCB's) for the EFM32LG995.

4.1 Pinout

The EFM32LG995 pinout is shown in Figure 4.1 (p. 46) and Table 4.1 (p. 46). Alternate locations are denoted by "#" followed by the location number (Multiple locations on the same pin are split with "/"). Alternate locations can be configured in the LOCATION bitfield in the *_ROUTE register in the module in question.

Figure 4.1. EFM32LG995 Pinout (top view, not to scale)

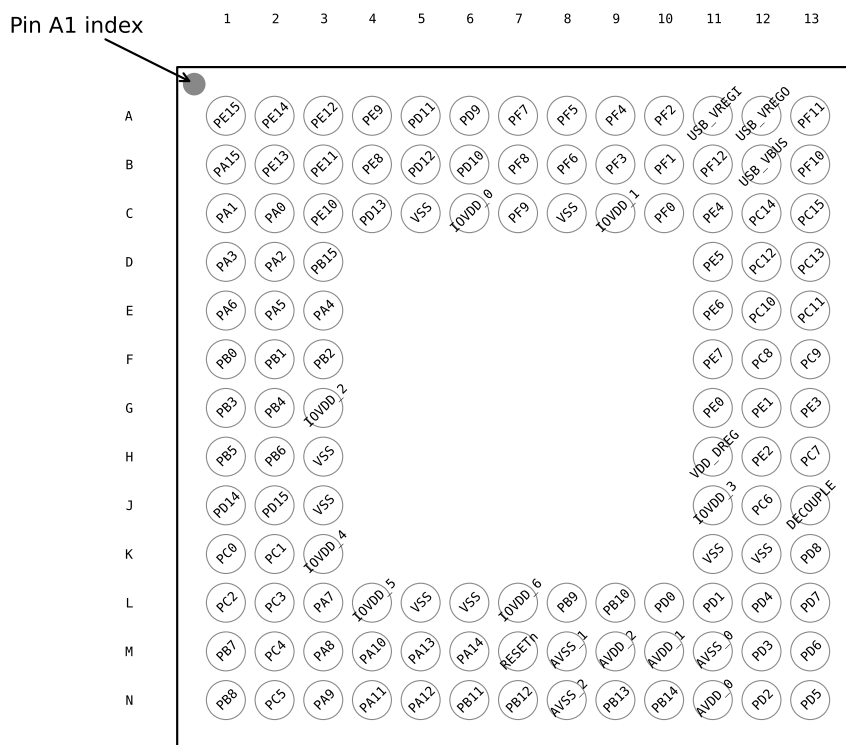

Table 4.1. Device Pinout

BGA120 Pin# and Name		Pin Alternate Functionality / Description				
Pin #	Pin Name	Analog	EBI	Timers	Communication	Other
A1	PE15	LCD_SEG11	EBI_AD07 #0/1/2	TIM3_CC1 #0	LEU0_RX #2	
A2	PE14	LCD_SEG10	EBI_AD06 #0/1/2	TIM3_CC0 #0	LEU0_TX #2	
A3	PE12	LCD_SEG8	EBI_AD04 #0/1/2	TIM1_CC2 #1	US0_RX #3 US0_CLK #0 I2C0_SDA #6	CMU_CLK1 #2 LES_ALTEX6 #0

BGA120 Pin# and Name		Pin Alternate Functionality / Description				
Pin #	Pin Name	Analog	EBI	Timers	Communication	Other
A4	PE9	LCD_SEG5	EBI_AD01 #0/1/2	PCNT2_S1IN #1		
A5	PD11	LCD_SEG30	EBI_CS2 #0/1/2			
A6	PD9	LCD_SEG28	EBI_CS0 #0/1/2			
A7	PF7	LCD_SEG25	EBI_BL1 #0/1/2	TIM0_CC1 #2	U0_RX #0	
A8	PF5	LCD_SEG3	EBI_REn #0/2	TIM0_CDTI2 #2/5	USB_VBUSEN #0	PRS_CH2 #1
A9	PF4	LCD_SEG2	EBI_WEn #0/2	TIM0_CDTI1 #2/5		PRS_CH1 #1
A10	PF2	LCD_SEG0	EBI_ARDY #0/1/2	TIM0_CC2 #5	LEU0_TX #4	ACMP1_O #0 DBG_SWO #0 GPIO_EM4WU4
A11	USB_VREGI	USB Input to internal 3.3 V regulator.				
A12	USB_VREGO	USB Decoupling for internal 3.3 V USB regulator and regulator output.				
A13	PF11				U1_RX #1 USB_DP #0	
B1	PA15	LCD_SEG12	EBI_AD08 #0/1/2	TIM3_CC2 #0		
B2	PE13	LCD_SEG9	EBI_AD05 #0/1/2		US0_TX #3 US0_CS #0 I2C0_SCL #6	LES_ALTEX7 #0 ACMP0_O #0 GPIO_EM4WU5
B3	PE11	LCD_SEG7	EBI_AD03 #0/1/2	TIM1_CC1 #1	US0_RX #0	LES_ALTEX5 #0 BOOTLOADER_RX
B4	PE8	LCD_SEG4	EBI_AD00 #0/1/2	PCNT2_S0IN #1		PRS_CH3 #1
B5	PD12	LCD_SEG31	EBI_CS3 #0/1/2			
B6	PD10	LCD_SEG29	EBI_CS1 #0/1/2			
B7	PF8	LCD_SEG26	EBI_WEn #1	TIM0_CC2 #2		ETM_TCLK #1
B8	PF6	LCD_SEG24	EBI_BL0 #0/1/2	TIM0_CC0 #2	U0_TX #0	
B9	PF3	LCD_SEG1	EBI_ALE #0	TIM0_CDTI0 #2/5		PRS_CH0 #1 ETM_TD3 #1
B10	PF1			TIM0_CC1 #5 LETIM0_OUT1 #2	US1_CS #2 LEU0_RX #3 I2C0_SCL #5	DBG_SWDIO #0/1/2/3 GPIO_EM4WU3
B11	PF12				USB_ID #0	
B12	USB_VBUS	USB 5.0 V VBUS input.				
B13	PF10				U1_TX #1 USB_DM #0	
C1	PA1	LCD_SEG14	EBI_AD10 #0/1/2	TIM0_CC1 #0/1	I2C0_SCL #0	CMU_CLK1 #0 PRS_CH1 #0
C2	PA0	LCD_SEG13	EBI_AD09 #0/1/2	TIM0_CC0 #0/1/4	LEU0_RX #4 I2C0_SDA #0	PRS_CH0 #0 GPIO_EM4WU0
C3	PE10	LCD_SEG6	EBI_AD02 #0/1/2	TIM1_CC0 #1	US0_TX #0	BOOTLOADER_TX
C4	PD13					ETM_TD1 #1
C5	VSS	Ground				
C6	IOVDD_0	Digital IO power supply 0.				
C7	PF9	LCD_SEG27	EBI_REn #1			ETM_TD0 #1
C8	VSS	Ground				
C9	IOVDD_1	Digital IO power supply 1.				
C10	PF0			TIM0_CC0 #5 LETIM0_OUT0 #2	US1_CLK #2 LEU0_TX #3	DBG_SWCLK #0/1/2/3

BGA120 Pin# and Name		Pin Alternate Functionality / Description				
Pin #	Pin Name	Analog	EBI	Timers	Communication	Other
					I2C0_SDA #5	
C11	PE4	LCD_COM0	EBI_A11 #0/1/2		US0_CS #1	
C12	PC14	DAC0_OUT1ALT #2/ OPAMP_OUT1ALT ACMP1_CH6		TIM0_CDTI1 #1/3 TIM1_CC1 #0 PCNT0_S1IN #0	US0_CS #3 U0_TX #3	LES_CH14 #0
C13	PC15	DAC0_OUT1ALT #3/ OPAMP_OUT1ALT ACMP1_CH7		TIM0_CDTI2 #1/3 TIM1_CC2 #0	US0_CLK #3 U0_RX #3	LES_CH15 #0 DBG_SWO #1
D1	PA3	LCD_SEG16	EBI_AD12 #0/1/2	TIM0_CDTI0 #0	U0_TX #2	LES_ALTEX2 #0 ETM_TD1 #3
D2	PA2	LCD_SEG15	EBI_AD11 #0/1/2	TIM0_CC2 #0/1		CMU_CLK0 #0 ETM_TD0 #3
D3	PB15					ETM_TD2 #1
D11	PE5	LCD_COM1	EBI_A12 #0/1/2		US0_CLK #1	
D12	PC12	DAC0_OUT1ALT #0/ OPAMP_OUT1ALT ACMP1_CH4			U1_TX #0	CMU_CLK0 #1 LES_CH12 #0
D13	PC13	DAC0_OUT1ALT #1/ OPAMP_OUT1ALT ACMP1_CH5		TIM0_CDTI0 #1/3 TIM1_CC0 #0 TIM1_CC2 #4 PCNT0_S0IN #0	U1_RX #0	LES_CH13 #0
E1	PA6	LCD_SEG19	EBI_AD15 #0/1/2		LEU1_RX #1	ETM_TCLK #3 GPIO_EM4WU1
E2	PA5	LCD_SEG18	EBI_AD14 #0/1/2	TIM0_CDTI2 #0	LEU1_TX #1	LES_ALTEX4 #0 ETM_TD3 #3
E3	PA4	LCD_SEG17	EBI_AD13 #0/1/2	TIM0_CDTI1 #0	U0_RX #2	LES_ALTEX3 #0 ETM_TD2 #3
E11	PE6	LCD_COM2	EBI_A13 #0/1/2		US0_RX #1	
E12	PC10	ACMP1_CH2	EBI_A10 #1/2	TIM2_CC2 #2	US0_RX #2	LES_CH10 #0
E13	PC11	ACMP1_CH3	EBI_ALE #1/2		US0_TX #2	LES_CH11 #0
F1	PB0	LCD_SEG32	EBI_A16 #0/1/2	TIM1_CC0 #2		
F2	PB1	LCD_SEG33	EBI_A17 #0/1/2	TIM1_CC1 #2		
F3	PB2	LCD_SEG34	EBI_A18 #0/1/2	TIM1_CC2 #2		
F11	PE7	LCD_COM3	EBI_A14 #0/1/2		US0_TX #1	
F12	PC8	ACMP1_CH0	EBI_A15 #0/1/2	TIM2_CC0 #2	US0_CS #2	LES_CH8 #0
F13	PC9	ACMP1_CH1	EBI_A09 #1/2	TIM2_CC1 #2	US0_CLK #2	LES_CH9 #0 GPIO_EM4WU2
G1	PB3	LCD_SEG20/ LCD_COM4	EBI_A19 #0/1/2	PCNT1_S0IN #1	US2_TX #1	
G2	PB4	LCD_SEG21/ LCD_COM5	EBI_A20 #0/1/2	PCNT1_S1IN #1	US2_RX #1	
G3	IOVDD_2	Digital IO power supply 2.				
G11	PE0		EBI_A07 #0/1/2	TIM3_CC0 #1 PCNT0_S0IN #1	U0_TX #1 I2C1_SDA #2	
G12	PE1		EBI_A08 #0/1/2	TIM3_CC1 #1 PCNT0_S1IN #1	U0_RX #1 I2C1_SCL #2	
G13	PE3	BU_STAT	EBI_A10 #0		U1_RX #3	ACMP1_O #1
H1	PB5	LCD_SEG22/ LCD_COM6	EBI_A21 #0/1/2		US2_CLK #1	
H2	PB6	LCD_SEG23/	EBI_A22 #0/1/2		US2_CS #1	

BGA120 Pin# and Name		Pin Alternate Functionality / Description				
Pin #	Pin Name	Analog	EBI	Timers	Communication	Other
		LCD_COM7				
H3	VSS	Ground				
H11	VDD_DREG	Power supply for on-chip voltage regulator.				
H12	PE2	BU_VOUT	EBI_A09 #0	TIM3_CC2 #1	U1_TX #3	ACMP0_O #1
H13	PC7	ACMP0_CH7	EBI_A06 #0/1/2		LEU1_RX #0 I2C0_SCL #2	LES_CH7 #0 ETM_TD0 #2
J1	PD14				I2C0_SDA #3	
J2	PD15				I2C0_SCL #3	
J3	VSS	Ground				
J11	IOVDD_3	Digital IO power supply 3.				
J12	PC6	ACMP0_CH6	EBI_A05 #0/1/2		LEU1_TX #0 I2C0_SDA #2	LES_CH6 #0 ETM_TCLK #2
J13	DECOUPLE	Decouple output for on-chip voltage regulator. An external capacitance of size C _{DECOUPLE} is required at this pin.				
K1	PC0	DAC0_OUT0ALT #0/ OPAMP_OUT0ALT ACMP0_CH0	EBI_A23 #0/1/2	TIM0_CC1 #4 PCNT0_S0IN #2	US0_TX #5 US1_TX #0 I2C0_SDA #4	LES_CH0 #0 PRS_CH2 #0
K2	PC1	DAC0_OUT0ALT #1/ OPAMP_OUT0ALT ACMP0_CH1	EBI_A24 #0/1/2	TIM0_CC2 #4 PCNT0_S1IN #2	US0_RX #5 US1_RX #0 I2C0_SCL #4	LES_CH1 #0 PRS_CH3 #0
K3	IOVDD_4	Digital IO power supply 4.				
K11	VSS	Ground				
K12	VSS	Ground				
K13	PD8	BU_VIN				CMU_CLK1 #1
L1	PC2	DAC0_OUT0ALT #2/ OPAMP_OUT0ALT ACMP0_CH2	EBI_A25 #0/1/2	TIM0_CDTI0 #4	US2_TX #0	LES_CH2 #0
L2	PC3	DAC0_OUT0ALT #3/ OPAMP_OUT0ALT ACMP0_CH3	EBI_NANDREn #0/1/2	TIM0_CDTI1 #4	US2_RX #0	LES_CH3 #0
L3	PA7	LCD_SEG35	EBI_CSTFT #0/1/2			
L4	IOVDD_5	Digital IO power supply 5.				
L5	VSS	Ground				
L6	VSS	Ground				
L7	IOVDD_6	Digital IO power supply 6.				
L8	PB9		EBI_A03 #0/1/2		U1_TX #2	
L9	PB10		EBI_A04 #0/1/2		U1_RX #2	
L10	PD0	ADC0_CH0 DAC0_OUT0ALT #4/ OPAMP_OUT0ALT DAC0_OUT2 #1/ OPAMP_OUT2		PCNT2_S0IN #0	US1_TX #1	
L11	PD1	ADC0_CH1 DAC0_OUT1ALT #4/ OPAMP_OUT1ALT		TIM0_CC0 #3 PCNT2_S1IN #0	US1_RX #1	DBG_SWO #2
L12	PD4	ADC0_CH4 DAC0_P2 #0/ OPAMP_P2			LEU0_TX #0	ETM_TD2 #0/2
L13	PD7	ADC0_CH7 DAC0_N1 #0/ OPAMP_N1		TIM1_CC1 #4 LETIM0_OUT1 #0 PCNT0_S1IN #3	US1_TX #2 I2C0_SCL #1	CMU_CLK0 #2 LES_ALTEX1 #0 ACMP1_O #2

BGA120 Pin# and Name		Pin Alternate Functionality / Description				
Pin #	Pin Name	Analog	EBI	Timers	Communication	Other
						ETM_TCLK #0
M1	PB7	LFXTAL_P		TIM1_CC0 #3	US0_TX #4 US1_CLK #0	
M2	PC4	DAC0_P0 #0/ OPAMP_P0 ACMP0_CH4	EBI_A26 #0/1/2	TIM0_CDTI2 #4 LETIM0_OUT0 #3 PCNT1_S0IN #0	US2_CLK #0 I2C1_SDA #0	LES_CH4 #0
M3	PA8	LCD_SEG36	EBI_DCLK #0/1/2	TIM2_CC0 #0		
M4	PA10	LCD_SEG38	EBI_VSNCR #0/1/2	TIM2_CC2 #0		
M5	PA13	LCD_BCAPP_N	EBI_A01 #0/1/2	TIM2_CC1 #1		
M6	PA14	LCD_BEXT	EBI_A02 #0/1/2	TIM2_CC2 #1		
M7	RESETn	Reset input. Active low, with internal pull-up.				
M8	AVSS_1	Analog ground 1.				
M9	AVDD_2	Analog power supply 2.				
M10	AVDD_1	Analog power supply 1.				
M11	AVSS_0	Analog ground 0.				
M12	PD3	ADC0_CH3 DAC0_N2 #0/ OPAMP_N2		TIM0_CC2 #3	US1_CS #1	ETM_TD1 #0/2
M13	PD6	ADC0_CH6 DAC0_P1 #0/ OPAMP_P1		TIM1_CC0 #4 LETIM0_OUT0 #0 PCNT0_S0IN #3	US1_RX #2 I2C0_SDA #1	LES_ALTEX0 #0 ACMP0_O #2 ETM_TD0 #0
N1	PB8	LFXTAL_N		TIM1_CC1 #3	US0_RX #4 US1_CS #0	
N2	PC5	DAC0_N0 #0/ OPAMP_N0 ACMP0_CH5	EBI_NANDWEn #0/1/2	LETIM0_OUT1 #3 PCNT1_S1IN #0	US2_CS #0 I2C1_SCL #0	LES_CH5 #0
N3	PA9	LCD_SEG37	EBI_DTEN #0/1/2	TIM2_CC1 #0		
N4	PA11	LCD_SEG39	EBI_HSNCR #0/1/2			
N5	PA12	LCD_BCAPP_P	EBI_A00 #0/1/2	TIM2_CC0 #1		
N6	PB11	DAC0_OUT0 #0/ OPAMP_OUT0		TIM1_CC2 #3 LETIM0_OUT0 #1	I2C1_SDA #1	
N7	PB12	DAC0_OUT1 #0/ OPAMP_OUT1		LETIM0_OUT1 #1	I2C1_SCL #1	
N8	AVSS_2	Analog ground 2.				
N9	PB13	HFXTAL_P			US0_CLK #4/5 LEU0_TX #1	
N10	PB14	HFXTAL_N			US0_CS #4/5 LEU0_RX #1	
N11	AVDD_0	Analog power supply 0.				
N12	PD2	ADC0_CH2	EBI_A27 #0/1/2	TIM0_CC1 #3	US1_CLK #1 USB_DMPU #0	DBG_SWO #3
N13	PD5	ADC0_CH5 DAC0_OUT2 #0/ OPAMP_OUT2			LEU0_RX #0	ETM_TD3 #0/2

4.2 Alternate functionality pinout

A wide selection of alternate functionality is available for multiplexing to various pins. This is shown in Table 4.2 (p. 51). The table shows the name of the alternate functionality in the first column, followed by columns showing the possible LOCATION bitfield settings.

Note

Some functionality, such as analog interfaces, do not have alternate settings or a LOCATION bitfield. In these cases, the pinout is shown in the column corresponding to LOCATION 0.

Table 4.2. Alternate functionality overview

Alternate Functionality	LOCATION							Description
	0	1	2	3	4	5	6	
ACMP0_CH0	PC0							Analog comparator ACMP0, channel 0.
ACMP0_CH1	PC1							Analog comparator ACMP0, channel 1.
ACMP0_CH2	PC2							Analog comparator ACMP0, channel 2.
ACMP0_CH3	PC3							Analog comparator ACMP0, channel 3.
ACMP0_CH4	PC4							Analog comparator ACMP0, channel 4.
ACMP0_CH5	PC5							Analog comparator ACMP0, channel 5.
ACMP0_CH6	PC6							Analog comparator ACMP0, channel 6.
ACMP0_CH7	PC7							Analog comparator ACMP0, channel 7.
ACMP0_O	PE13	PE2	PD6					Analog comparator ACMP0, digital output.
ACMP1_CH0	PC8							Analog comparator ACMP1, channel 0.
ACMP1_CH1	PC9							Analog comparator ACMP1, channel 1.
ACMP1_CH2	PC10							Analog comparator ACMP1, channel 2.
ACMP1_CH3	PC11							Analog comparator ACMP1, channel 3.
ACMP1_CH4	PC12							Analog comparator ACMP1, channel 4.
ACMP1_CH5	PC13							Analog comparator ACMP1, channel 5.
ACMP1_CH6	PC14							Analog comparator ACMP1, channel 6.
ACMP1_CH7	PC15							Analog comparator ACMP1, channel 7.
ACMP1_O	PF2	PE3	PD7					Analog comparator ACMP1, digital output.
ADC0_CH0	PD0							Analog to digital converter ADC0, input channel number 0.
ADC0_CH1	PD1							Analog to digital converter ADC0, input channel number 1.
ADC0_CH2	PD2							Analog to digital converter ADC0, input channel number 2.
ADC0_CH3	PD3							Analog to digital converter ADC0, input channel number 3.
ADC0_CH4	PD4							Analog to digital converter ADC0, input channel number 4.
ADC0_CH5	PD5							Analog to digital converter ADC0, input channel number 5.
ADC0_CH6	PD6							Analog to digital converter ADC0, input channel number 6.
ADC0_CH7	PD7							Analog to digital converter ADC0, input channel number 7.
BOOTLOADER_RX	PE11							Bootloader RX
BOOTLOADER_TX	PE10							Bootloader TX
BU_STAT	PE3							Backup Power Domain status, whether or not the system is in backup mode
BU_VIN	PD8							Battery input for Backup Power Domain
BU_VOUT	PE2							Power output for Backup Power Domain

Alternate	LOCATION							Description
	0	1	2	3	4	5	6	
CMU_CLK0	PA2	PC12	PD7					Clock Management Unit, clock output number 0.
CMU_CLK1	PA1	PD8	PE12					Clock Management Unit, clock output number 1.
DAC0_N0 / OPAMP_N0	PC5							Operational Amplifier 0 external negative input.
DAC0_N1 / OPAMP_N1	PD7							Operational Amplifier 1 external negative input.
DAC0_N2 / OPAMP_N2	PD3							Operational Amplifier 2 external negative input.
DAC0_OUT0 / OPAMP_OUT0	PB11							Digital to Analog Converter DAC0_OUT0 / OPAMP output channel number 0.
DAC0_OUT0ALT / OPAMP_OUT0ALT	PC0	PC1	PC2	PC3	PD0			Digital to Analog Converter DAC0_OUT0ALT / OPAMP alternative output for channel 0.
DAC0_OUT1 / OPAMP_OUT1	PB12							Digital to Analog Converter DAC0_OUT1 / OPAMP output channel number 1.
DAC0_OUT1ALT / OPAMP_OUT1ALT	PC12	PC13	PC14	PC15	PD1			Digital to Analog Converter DAC0_OUT1ALT / OPAMP alternative output for channel 1.
DAC0_OUT2 / OPAMP_OUT2	PD5	PD0						Digital to Analog Converter DAC0_OUT2 / OPAMP output channel number 2.
DAC0_P0 / OPAMP_P0	PC4							Operational Amplifier 0 external positive input.
DAC0_P1 / OPAMP_P1	PD6							Operational Amplifier 1 external positive input.
DAC0_P2 / OPAMP_P2	PD4							Operational Amplifier 2 external positive input.
DBG_SWCLK	PF0	PF0	PF0	PF0				Debug-interface Serial Wire clock input. Note that this function is enabled to pin out of reset, and has a built-in pull down.
DBG_SWDIO	PF1	PF1	PF1	PF1				Debug-interface Serial Wire data input / output. Note that this function is enabled to pin out of reset, and has a built-in pull up.
DBG_SWO	PF2	PC15	PD1	PD2				Debug-interface Serial Wire viewer Output. Note that this function is not enabled after reset, and must be enabled by software to be used.
EBI_A00	PA12	PA12	PA12					External Bus Interface (EBI) address output pin 00.
EBI_A01	PA13	PA13	PA13					External Bus Interface (EBI) address output pin 01.
EBI_A02	PA14	PA14	PA14					External Bus Interface (EBI) address output pin 02.
EBI_A03	PB9	PB9	PB9					External Bus Interface (EBI) address output pin 03.
EBI_A04	PB10	PB10	PB10					External Bus Interface (EBI) address output pin 04.
EBI_A05	PC6	PC6	PC6					External Bus Interface (EBI) address output pin 05.
EBI_A06	PC7	PC7	PC7					External Bus Interface (EBI) address output pin 06.
EBI_A07	PE0	PE0	PE0					External Bus Interface (EBI) address output pin 07.
EBI_A08	PE1	PE1	PE1					External Bus Interface (EBI) address output pin 08.
EBI_A09	PE2	PC9	PC9					External Bus Interface (EBI) address output pin 09.
EBI_A10	PE3	PC10	PC10					External Bus Interface (EBI) address output pin 10.
EBI_A11	PE4	PE4	PE4					External Bus Interface (EBI) address output pin 11.
EBI_A12	PE5	PE5	PE5					External Bus Interface (EBI) address output pin 12.
EBI_A13	PE6	PE6	PE6					External Bus Interface (EBI) address output pin 13.
EBI_A14	PE7	PE7	PE7					External Bus Interface (EBI) address output pin 14.
EBI_A15	PC8	PC8	PC8					External Bus Interface (EBI) address output pin 15.

Alternate	LOCATION							Description
	0	1	2	3	4	5	6	
EBI_A16	PB0	PB0	PB0					External Bus Interface (EBI) address output pin 16.
EBI_A17	PB1	PB1	PB1					External Bus Interface (EBI) address output pin 17.
EBI_A18	PB2	PB2	PB2					External Bus Interface (EBI) address output pin 18.
EBI_A19	PB3	PB3	PB3					External Bus Interface (EBI) address output pin 19.
EBI_A20	PB4	PB4	PB4					External Bus Interface (EBI) address output pin 20.
EBI_A21	PB5	PB5	PB5					External Bus Interface (EBI) address output pin 21.
EBI_A22	PB6	PB6	PB6					External Bus Interface (EBI) address output pin 22.
EBI_A23	PC0	PC0	PC0					External Bus Interface (EBI) address output pin 23.
EBI_A24	PC1	PC1	PC1					External Bus Interface (EBI) address output pin 24.
EBI_A25	PC2	PC2	PC2					External Bus Interface (EBI) address output pin 25.
EBI_A26	PC4	PC4	PC4					External Bus Interface (EBI) address output pin 26.
EBI_A27	PD2	PD2	PD2					External Bus Interface (EBI) address output pin 27.
EBI_AD00	PE8	PE8	PE8					External Bus Interface (EBI) address and data input / output pin 00.
EBI_AD01	PE9	PE9	PE9					External Bus Interface (EBI) address and data input / output pin 01.
EBI_AD02	PE10	PE10	PE10					External Bus Interface (EBI) address and data input / output pin 02.
EBI_AD03	PE11	PE11	PE11					External Bus Interface (EBI) address and data input / output pin 03.
EBI_AD04	PE12	PE12	PE12					External Bus Interface (EBI) address and data input / output pin 04.
EBI_AD05	PE13	PE13	PE13					External Bus Interface (EBI) address and data input / output pin 05.
EBI_AD06	PE14	PE14	PE14					External Bus Interface (EBI) address and data input / output pin 06.
EBI_AD07	PE15	PE15	PE15					External Bus Interface (EBI) address and data input / output pin 07.
EBI_AD08	PA15	PA15	PA15					External Bus Interface (EBI) address and data input / output pin 08.
EBI_AD09	PA0	PA0	PA0					External Bus Interface (EBI) address and data input / output pin 09.
EBI_AD10	PA1	PA1	PA1					External Bus Interface (EBI) address and data input / output pin 10.
EBI_AD11	PA2	PA2	PA2					External Bus Interface (EBI) address and data input / output pin 11.
EBI_AD12	PA3	PA3	PA3					External Bus Interface (EBI) address and data input / output pin 12.
EBI_AD13	PA4	PA4	PA4					External Bus Interface (EBI) address and data input / output pin 13.
EBI_AD14	PA5	PA5	PA5					External Bus Interface (EBI) address and data input / output pin 14.
EBI_AD15	PA6	PA6	PA6					External Bus Interface (EBI) address and data input / output pin 15.
EBI_ALE	PF3	PC11	PC11					External Bus Interface (EBI) Address Latch Enable output.
EBI_ARDY	PF2	PF2	PF2					External Bus Interface (EBI) Hardware Ready Control input.
EBI_BL0	PF6	PF6	PF6					External Bus Interface (EBI) Byte Lane/Enable pin 0.
EBI_BL1	PF7	PF7	PF7					External Bus Interface (EBI) Byte Lane/Enable pin 1.
EBI_CS0	PD9	PD9	PD9					External Bus Interface (EBI) Chip Select output 0.

Alternate	LOCATION							Description
	0	1	2	3	4	5	6	
EBI_CS1	PD10	PD10	PD10					External Bus Interface (EBI) Chip Select output 1.
EBI_CS2	PD11	PD11	PD11					External Bus Interface (EBI) Chip Select output 2.
EBI_CS3	PD12	PD12	PD12					External Bus Interface (EBI) Chip Select output 3.
EBI_CSTFT	PA7	PA7	PA7					External Bus Interface (EBI) Chip Select output TFT.
EBI_DCLK	PA8	PA8	PA8					External Bus Interface (EBI) TFT Dot Clock pin.
EBI_DTEN	PA9	PA9	PA9					External Bus Interface (EBI) TFT Data Enable pin.
EBI_HSNc	PA11	PA11	PA11					External Bus Interface (EBI) TFT Horizontal Synchronization pin.
EBI_NANDREn	PC3	PC3	PC3					External Bus Interface (EBI) NAND Read Enable output.
EBI_NANDWEn	PC5	PC5	PC5					External Bus Interface (EBI) NAND Write Enable output.
EBI_REn	PF5	PF9	PF5					External Bus Interface (EBI) Read Enable output.
EBI_VSNc	PA10	PA10	PA10					External Bus Interface (EBI) TFT Vertical Synchronization pin.
EBI_WEn	PF4	PF8	PF4					External Bus Interface (EBI) Write Enable output.
ETM_TCLK	PD7	PF8	PC6	PA6				Embedded Trace Module ETM clock .
ETM_TD0	PD6	PF9	PC7	PA2				Embedded Trace Module ETM data 0.
ETM_TD1	PD3	PD13	PD3	PA3				Embedded Trace Module ETM data 1.
ETM_TD2	PD4	PB15	PD4	PA4				Embedded Trace Module ETM data 2.
ETM_TD3	PD5	PF3	PD5	PA5				Embedded Trace Module ETM data 3.
GPIO_EM4WU0	PA0							Pin can be used to wake the system up from EM4
GPIO_EM4WU1	PA6							Pin can be used to wake the system up from EM4
GPIO_EM4WU2	PC9							Pin can be used to wake the system up from EM4
GPIO_EM4WU3	PF1							Pin can be used to wake the system up from EM4
GPIO_EM4WU4	PF2							Pin can be used to wake the system up from EM4
GPIO_EM4WU5	PE13							Pin can be used to wake the system up from EM4
HFXTAL_N	PB14							High Frequency Crystal (4 - 48 MHz) negative pin. Also used as external optional clock input pin.
HFXTAL_P	PB13							High Frequency Crystal (4 - 48 MHz) positive pin.
I2C0_SCL	PA1	PD7	PC7	PD15	PC1	PF1	PE13	I2C0 Serial Clock Line input / output.
I2C0_SDA	PA0	PD6	PC6	PD14	PC0	PF0	PE12	I2C0 Serial Data input / output.
I2C1_SCL	PC5	PB12	PE1					I2C1 Serial Clock Line input / output.
I2C1_SDA	PC4	PB11	PE0					I2C1 Serial Data input / output.
LCD_BCAP_N	PA13							LCD voltage booster (optional), boost capacitor, negative pin. If using the LCD voltage booster, connect a 22 nF capacitor between LCD_BCAP_N and LCD_BCAP_P.
LCD_BCAP_P	PA12							LCD voltage booster (optional), boost capacitor, positive pin. If using the LCD voltage booster, connect a 22 nF capacitor between LCD_BCAP_N and LCD_BCAP_P.
LCD_BEXT	PA14							LCD voltage booster (optional), boost output. If using the LCD voltage booster, connect a 1 uF capacitor between this pin and VSS. An external LCD voltage may also be applied to this pin if the booster is not enabled. If AVDD is used directly as the LCD supply voltage, this pin may be left unconnected or used as a GPIO.
LCD_COM0	PE4							LCD driver common line number 0.
LCD_COM1	PE5							LCD driver common line number 1.

Alternate	LOCATION							Description
	0	1	2	3	4	5	6	
LCD_COM2	PE6							LCD driver common line number 2.
LCD_COM3	PE7							LCD driver common line number 3.
LCD_SEG0	PF2							LCD segment line 0. Segments 0, 1, 2 and 3 are controlled by SEGEN0.
LCD_SEG1	PF3							LCD segment line 1. Segments 0, 1, 2 and 3 are controlled by SEGEN0.
LCD_SEG2	PF4							LCD segment line 2. Segments 0, 1, 2 and 3 are controlled by SEGEN0.
LCD_SEG3	PF5							LCD segment line 3. Segments 0, 1, 2 and 3 are controlled by SEGEN0.
LCD_SEG4	PE8							LCD segment line 4. Segments 4, 5, 6 and 7 are controlled by SEGEN1.
LCD_SEG5	PE9							LCD segment line 5. Segments 4, 5, 6 and 7 are controlled by SEGEN1.
LCD_SEG6	PE10							LCD segment line 6. Segments 4, 5, 6 and 7 are controlled by SEGEN1.
LCD_SEG7	PE11							LCD segment line 7. Segments 4, 5, 6 and 7 are controlled by SEGEN1.
LCD_SEG8	PE12							LCD segment line 8. Segments 8, 9, 10 and 11 are controlled by SEGEN2.
LCD_SEG9	PE13							LCD segment line 9. Segments 8, 9, 10 and 11 are controlled by SEGEN2.
LCD_SEG10	PE14							LCD segment line 10. Segments 8, 9, 10 and 11 are controlled by SEGEN2.
LCD_SEG11	PE15							LCD segment line 11. Segments 8, 9, 10 and 11 are controlled by SEGEN2.
LCD_SEG12	PA15							LCD segment line 12. Segments 12, 13, 14 and 15 are controlled by SEGEN3.
LCD_SEG13	PA0							LCD segment line 13. Segments 12, 13, 14 and 15 are controlled by SEGEN3.
LCD_SEG14	PA1							LCD segment line 14. Segments 12, 13, 14 and 15 are controlled by SEGEN3.
LCD_SEG15	PA2							LCD segment line 15. Segments 12, 13, 14 and 15 are controlled by SEGEN3.
LCD_SEG16	PA3							LCD segment line 16. Segments 16, 17, 18 and 19 are controlled by SEGEN4.
LCD_SEG17	PA4							LCD segment line 17. Segments 16, 17, 18 and 19 are controlled by SEGEN4.
LCD_SEG18	PA5							LCD segment line 18. Segments 16, 17, 18 and 19 are controlled by SEGEN4.
LCD_SEG19	PA6							LCD segment line 19. Segments 16, 17, 18 and 19 are controlled by SEGEN4.
LCD_SEG20/ LCD_COM4	PB3							LCD segment line 20. Segments 20, 21, 22 and 23 are controlled by SEGEN5. This pin may also be used as LCD COM line 4
LCD_SEG21/ LCD_COM5	PB4							LCD segment line 21. Segments 20, 21, 22 and 23 are controlled by SEGEN5. This pin may also be used as LCD COM line 5
LCD_SEG22/ LCD_COM6	PB5							LCD segment line 22. Segments 20, 21, 22 and 23 are controlled by SEGEN5. This pin may also be used as LCD COM line 6
LCD_SEG23/ LCD_COM7	PB6							LCD segment line 23. Segments 20, 21, 22 and 23 are controlled by SEGEN5. This pin may also be used as LCD COM line 7
LCD_SEG24	PF6							LCD segment line 24. Segments 24, 25, 26 and 27 are controlled by SEGEN6.

Alternate	LOCATION							Description
	0	1	2	3	4	5	6	
LCD_SEG25	PF7							LCD segment line 25. Segments 24, 25, 26 and 27 are controlled by SEGEN6.
LCD_SEG26	PF8							LCD segment line 26. Segments 24, 25, 26 and 27 are controlled by SEGEN6.
LCD_SEG27	PF9							LCD segment line 27. Segments 24, 25, 26 and 27 are controlled by SEGEN6.
LCD_SEG28	PD9							LCD segment line 28. Segments 28, 29, 30 and 31 are controlled by SEGEN7.
LCD_SEG29	PD10							LCD segment line 29. Segments 28, 29, 30 and 31 are controlled by SEGEN7.
LCD_SEG30	PD11							LCD segment line 30. Segments 28, 29, 30 and 31 are controlled by SEGEN7.
LCD_SEG31	PD12							LCD segment line 31. Segments 28, 29, 30 and 31 are controlled by SEGEN7.
LCD_SEG32	PB0							LCD segment line 32. Segments 32, 33, 34 and 35 are controlled by SEGEN8.
LCD_SEG33	PB1							LCD segment line 33. Segments 32, 33, 34 and 35 are controlled by SEGEN8.
LCD_SEG34	PB2							LCD segment line 34. Segments 32, 33, 34 and 35 are controlled by SEGEN8.
LCD_SEG35	PA7							LCD segment line 35. Segments 32, 33, 34 and 35 are controlled by SEGEN8.
LCD_SEG36	PA8							LCD segment line 36. Segments 36, 37, 38 and 39 are controlled by SEGEN9.
LCD_SEG37	PA9							LCD segment line 37. Segments 36, 37, 38 and 39 are controlled by SEGEN9.
LCD_SEG38	PA10							LCD segment line 38. Segments 36, 37, 38 and 39 are controlled by SEGEN9.
LCD_SEG39	PA11							LCD segment line 39. Segments 36, 37, 38 and 39 are controlled by SEGEN9.
LES_ALTEX0	PD6							LESENSE alternate exite output 0.
LES_ALTEX1	PD7							LESENSE alternate exite output 1.
LES_ALTEX2	PA3							LESENSE alternate exite output 2.
LES_ALTEX3	PA4							LESENSE alternate exite output 3.
LES_ALTEX4	PA5							LESENSE alternate exite output 4.
LES_ALTEX5	PE11							LESENSE alternate exite output 5.
LES_ALTEX6	PE12							LESENSE alternate exite output 6.
LES_ALTEX7	PE13							LESENSE alternate exite output 7.
LES_CH0	PC0							LESENSE channel 0.
LES_CH1	PC1							LESENSE channel 1.
LES_CH2	PC2							LESENSE channel 2.
LES_CH3	PC3							LESENSE channel 3.
LES_CH4	PC4							LESENSE channel 4.
LES_CH5	PC5							LESENSE channel 5.
LES_CH6	PC6							LESENSE channel 6.
LES_CH7	PC7							LESENSE channel 7.
LES_CH8	PC8							LESENSE channel 8.
LES_CH9	PC9							LESENSE channel 9.
LES_CH10	PC10							LESENSE channel 10.

Alternate	LOCATION							Description
	0	1	2	3	4	5	6	
LES_CH11	PC11							LESENSE channel 11.
LES_CH12	PC12							LESENSE channel 12.
LES_CH13	PC13							LESENSE channel 13.
LES_CH14	PC14							LESENSE channel 14.
LES_CH15	PC15							LESENSE channel 15.
LETIM0_OUT0	PD6	PB11	PF0	PC4				Low Energy Timer LETIM0, output channel 0.
LETIM0_OUT1	PD7	PB12	PF1	PC5				Low Energy Timer LETIM0, output channel 1.
LEU0_RX	PD5	PB14	PE15	PF1	PA0			LEUART0 Receive input.
LEU0_TX	PD4	PB13	PE14	PF0	PF2			LEUART0 Transmit output. Also used as receive input in half duplex communication.
LEU1_RX	PC7	PA6						LEUART1 Receive input.
LEU1_TX	PC6	PA5						LEUART1 Transmit output. Also used as receive input in half duplex communication.
LFXTAL_N	PB8							Low Frequency Crystal (typically 32.768 kHz) negative pin. Also used as an optional external clock input pin.
LFXTAL_P	PB7							Low Frequency Crystal (typically 32.768 kHz) positive pin.
PCNT0_S0IN	PC13	PE0	PC0	PD6				Pulse Counter PCNT0 input number 0.
PCNT0_S1IN	PC14	PE1	PC1	PD7				Pulse Counter PCNT0 input number 1.
PCNT1_S0IN	PC4	PB3						Pulse Counter PCNT1 input number 0.
PCNT1_S1IN	PC5	PB4						Pulse Counter PCNT1 input number 1.
PCNT2_S0IN	PD0	PE8						Pulse Counter PCNT2 input number 0.
PCNT2_S1IN	PD1	PE9						Pulse Counter PCNT2 input number 1.
PRS_CH0	PA0	PF3						Peripheral Reflex System PRS, channel 0.
PRS_CH1	PA1	PF4						Peripheral Reflex System PRS, channel 1.
PRS_CH2	PC0	PF5						Peripheral Reflex System PRS, channel 2.
PRS_CH3	PC1	PE8						Peripheral Reflex System PRS, channel 3.
TIM0_CC0	PA0	PA0	PF6	PD1	PA0	PF0		Timer 0 Capture Compare input / output channel 0.
TIM0_CC1	PA1	PA1	PF7	PD2	PC0	PF1		Timer 0 Capture Compare input / output channel 1.
TIM0_CC2	PA2	PA2	PF8	PD3	PC1	PF2		Timer 0 Capture Compare input / output channel 2.
TIM0_CDTI0	PA3	PC13	PF3	PC13	PC2	PF3		Timer 0 Complimentary Deat Time Insertion channel 0.
TIM0_CDTI1	PA4	PC14	PF4	PC14	PC3	PF4		Timer 0 Complimentary Deat Time Insertion channel 1.
TIM0_CDTI2	PA5	PC15	PF5	PC15	PC4	PF5		Timer 0 Complimentary Deat Time Insertion channel 2.
TIM1_CC0	PC13	PE10	PB0	PB7	PD6			Timer 1 Capture Compare input / output channel 0.
TIM1_CC1	PC14	PE11	PB1	PB8	PD7			Timer 1 Capture Compare input / output channel 1.
TIM1_CC2	PC15	PE12	PB2	PB11	PC13			Timer 1 Capture Compare input / output channel 2.
TIM2_CC0	PA8	PA12	PC8					Timer 2 Capture Compare input / output channel 0.
TIM2_CC1	PA9	PA13	PC9					Timer 2 Capture Compare input / output channel 1.
TIM2_CC2	PA10	PA14	PC10					Timer 2 Capture Compare input / output channel 2.
TIM3_CC0	PE14	PE0						Timer 3 Capture Compare input / output channel 0.
TIM3_CC1	PE15	PE1						Timer 3 Capture Compare input / output channel 1.
TIM3_CC2	PA15	PE2						Timer 3 Capture Compare input / output channel 2.
U0_RX	PF7	PE1	PA4	PC15				UART0 Receive input.

Alternate	LOCATION							Description
	0	1	2	3	4	5	6	
U0_TX	PF6	PE0	PA3	PC14				UART0 Transmit output. Also used as receive input in half duplex communication.
U1_RX	PC13	PF11	PB10	PE3				UART1 Receive input.
U1_TX	PC12	PF10	PB9	PE2				UART1 Transmit output. Also used as receive input in half duplex communication.
US0_CLK	PE12	PE5	PC9	PC15	PB13	PB13		USART0 clock input / output.
US0_CS	PE13	PE4	PC8	PC14	PB14	PB14		USART0 chip select input / output.
US0_RX	PE11	PE6	PC10	PE12	PB8	PC1		USART0 Asynchronous Receive. USART0 Synchronous mode Master Input / Slave Output (MISO).
US0_TX	PE10	PE7	PC11	PE13	PB7	PC0		USART0 Asynchronous Transmit. Also used as receive input in half duplex communication. USART0 Synchronous mode Master Output / Slave Input (MOSI).
US1_CLK	PB7	PD2	PF0					USART1 clock input / output.
US1_CS	PB8	PD3	PF1					USART1 chip select input / output.
US1_RX	PC1	PD1	PD6					USART1 Asynchronous Receive. USART1 Synchronous mode Master Input / Slave Output (MISO).
US1_TX	PC0	PD0	PD7					USART1 Asynchronous Transmit. Also used as receive input in half duplex communication. USART1 Synchronous mode Master Output / Slave Input (MOSI).
US2_CLK	PC4	PB5						USART2 clock input / output.
US2_CS	PC5	PB6						USART2 chip select input / output.
US2_RX	PC3	PB4						USART2 Asynchronous Receive. USART2 Synchronous mode Master Input / Slave Output (MISO).
US2_TX	PC2	PB3						USART2 Asynchronous Transmit. Also used as receive input in half duplex communication. USART2 Synchronous mode Master Output / Slave Input (MOSI).
USB_DM	PF10							USB D- pin.
USB_DMPU	PD2							USB D- Pullup control.
USB_DP	PF11							USB D+ pin.
USB_ID	PF12							USB ID pin. Used in OTG mode.
USB_VBUS	USB_VBUS							USB 5 V VBUS input.
USB_VBUSEN	PF5							USB 5 V VBUS enable.
USB_VREGI	USB_VREGI							USB Input to internal 3.3 V regulator
USB_VREGO	USV_VREGO							USB Decoupling for internal 3.3 V USB regulator and regulator output

4.3 GPIO pinout overview

The specific GPIO pins available in *EFM32LG995* is shown in Table 4.3 (p. 59). Each GPIO port is organized as 16-bit ports indicated by letters A through F, and the individual pin on this port is indicated by a number from 15 down to 0.

Table 4.3. GPIO Pinout

Port	Pin 15	Pin 14	Pin 13	Pin 12	Pin 11	Pin 10	Pin 9	Pin 8	Pin 7	Pin 6	Pin 5	Pin 4	Pin 3	Pin 2	Pin 1	Pin 0
Port A	PA15	PA14	PA13	PA12	PA11	PA10	PA9	PA8	PA7	PA6	PA5	PA4	PA3	PA2	PA1	PA0
Port B	PB15	PB14	PB13	PB12	PB11	PB10	PB9	PB8	PB7	PB6	PB5	PB4	PB3	PB2	PB1	PB0
Port C	PC15	PC14	PC13	PC12	PC11	PC10	PC9	PC8	PC7	PC6	PC5	PC4	PC3	PC2	PC1	PC0
Port D	PD15	PD14	PD13	PD12	PD11	PD10	PD9	PD8	PD7	PD6	PD5	PD4	PD3	PD2	PD1	PD0
Port E	PE15	PE14	PE13	PE12	PE11	PE10	PE9	PE8	PE7	PE6	PE5	PE4	PE3	PE2	PE1	PE0
Port F	-	-	-	PF12	PF11	PF10	PF9	PF8	PF7	PF6	PF5	PF4	PF3	PF2	PF1	PF0

4.4 Opamp pinout overview

The specific opamp terminals available in *EFM32LG995* is shown in Figure 4.2 (p. 59) .

Figure 4.2. Opamp Pinout

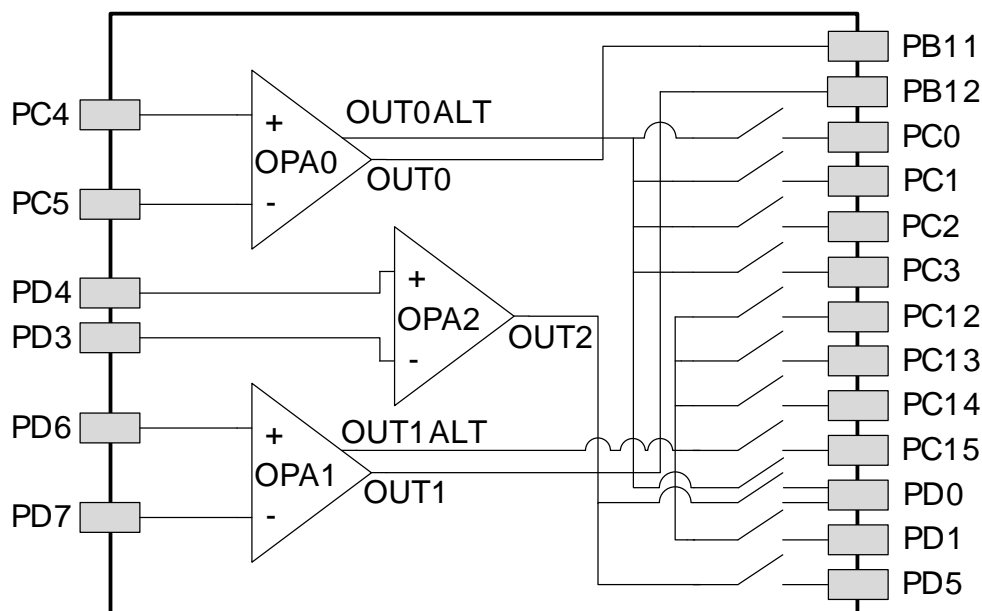

4.5 BGA120 Package

Figure 4.3. BGA120

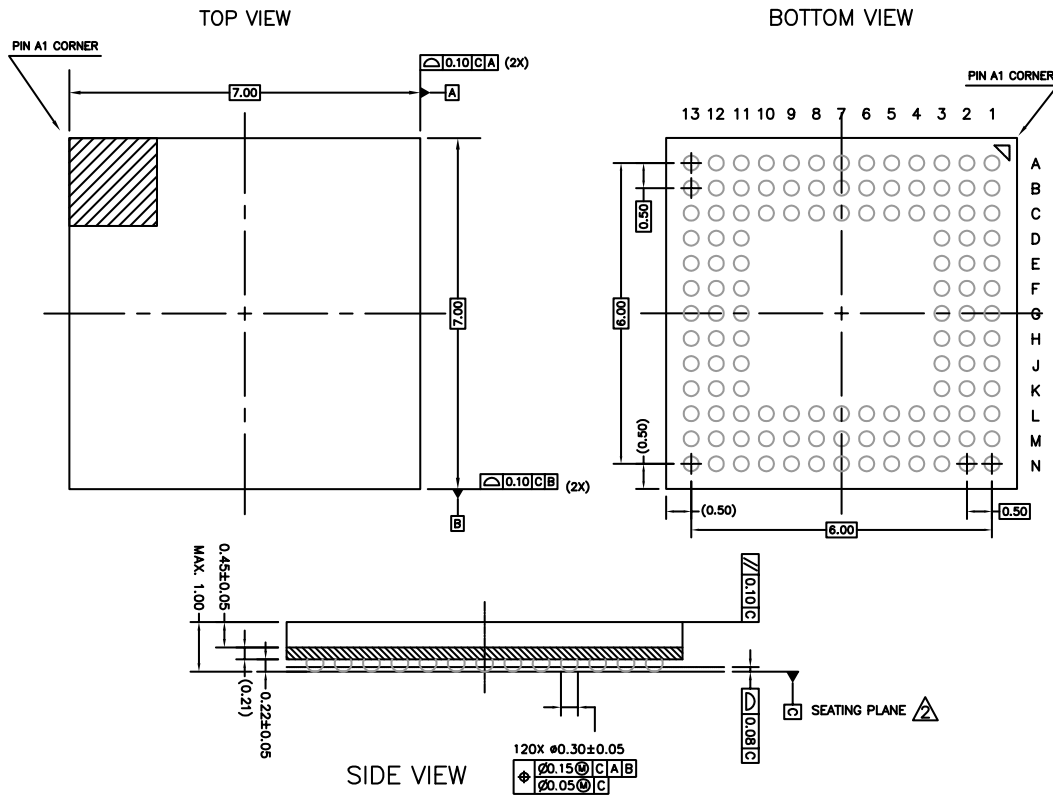

Rev: 975SP01321A_X01_06APR2011

Note:

1. The dimensions in parenthesis are reference.
2. Datum "C" and seating plane are defined by the crown of the solder balls.
3. All dimensions are in millimeters.

The BGA120 Package uses SAC105 solderballs.

All EFM32 packages are RoHS compliant and free of Bromine (Br) and Antimony (Sb).

5 PCB Layout and Soldering

5.1 Recommended PCB Layout

Figure 5.1. BGA120 PCB Land Pattern

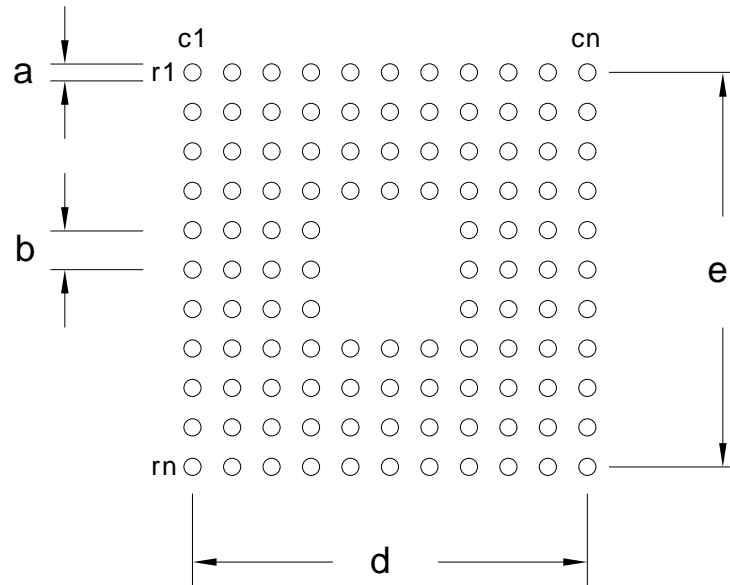

Table 5.1. BGA120 PCB Land Pattern Dimensions (Dimensions in mm)

Symbol	Dim. (mm)	Symbol	Row name and column number
a	0.25	r1	A
b	0.50	rn	N
d	6.00	c1	1
e	6.00	cn	13

Figure 5.2. BGA120 PCB Solder Mask

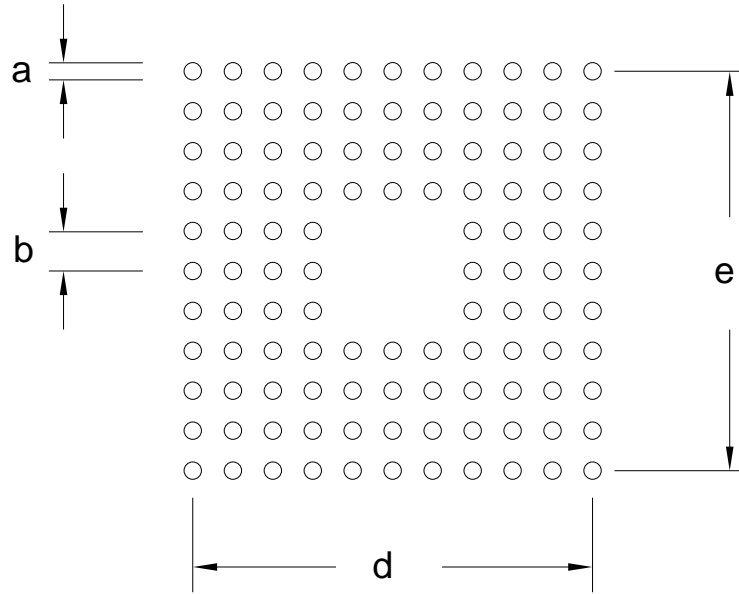

Table 5.2. BGA120 PCB Solder Mask Dimensions (Dimensions in mm)

Symbol	Dim. (mm)
a	0.35
b	0.50
d	6.00
e	6.00

Figure 5.3. BGA120 PCB Stencil Design

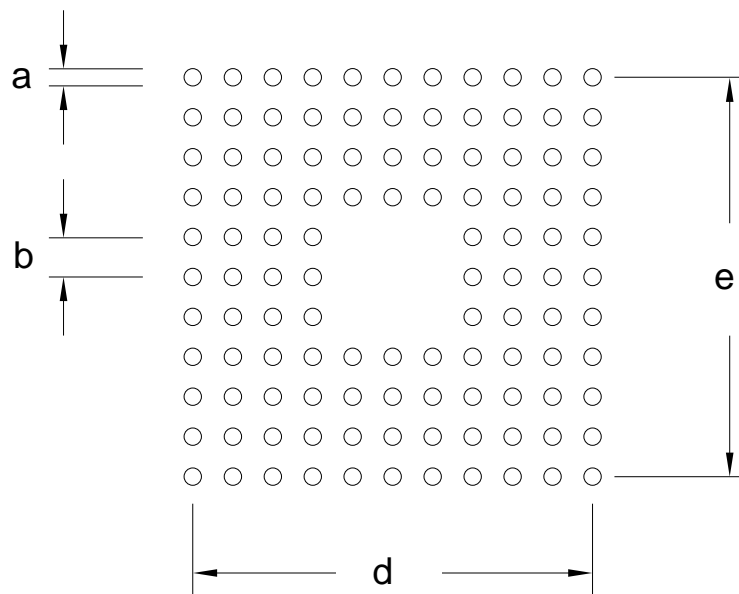

Table 5.3. BGA120 PCB Stencil Design Dimensions (Dimensions in mm)

Symbol	Dim. (mm)
a	0.25
b	0.50
d	6.00
e	6.00

1. The drawings are not to scale.
2. All dimensions are in millimeters.
3. All drawings are subject to change without notice.
4. The PCB Land Pattern drawing is in compliance with IPC-7351B.
5. Stencil thickness 0.125 mm.

5.2 Soldering Information

The latest IPC/JEDEC J-STD-020 recommendations for Pb-Free reflow soldering should be followed.

The packages have a Moisture Sensitivity Level rating of 3, please see the latest IPC/JEDEC J-STD-033 standard for MSL description and level 3 bake conditions.

6 Chip Marking, Revision and Errata

6.1 Chip Marking

In the illustration below package fields and position are shown.

Figure 6.1. Example Chip Marking

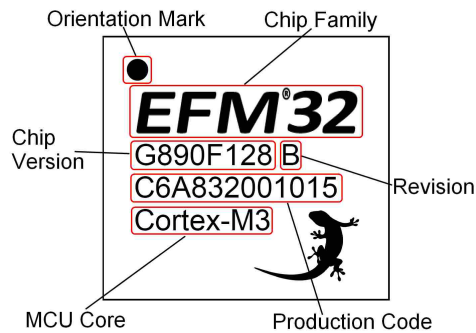

6.2 Revision

The revision of a chip can be determined from the "Revision" field in Figure 6.1 (p. 64). If the revision says "ES" (Engineering Sample), the revision must be read out electronically as specified in the reference manual.

6.3 Errata

Please see the [dxxxx_efm32lg995_errata.pdf](#) for description and resolution of device erratas. This document is available in Simplicity Studio and online at <http://www.energymicro.com/downloads/datasheets>.

7 Revision History

7.1 Revision 1.00

September 11th, 2012

Updated the HFRCO 1 MHz band typical value to 1.2 MHz.

Updated the HFRCO 7 MHz band typical value to 6.6 MHz.

Corrected BGA solder balls material from Sn96.5/Ag3/Cu0.5 to SAC105.

Other minor corrections.

7.2 Revision 0.92

May 25th, 2012

Corrected BGA solder balls material description.

Corrected EM3 current consumption in the Electrical Characteristics section.

7.3 Revision 0.90

April 27th, 2012

Initial preliminary release.

A Disclaimer and Trademarks

A.1 Disclaimer

Energy Micro AS intends to provide customers with the latest, accurate, and in-depth documentation of all peripherals and modules available for system and software implementers using or intending to use the Energy Micro products. Characterization data, available modules and peripherals, memory sizes and memory addresses refer to each specific device, and "Typical" parameters provided can and do vary in different applications. Application examples described herein are for illustrative purposes only. Energy Micro reserves the right to make changes without further notice and limitation to product information, specifications, and descriptions herein, and does not give warranties as to the accuracy or completeness of the included information. Energy Micro shall have no liability for the consequences of use of the information supplied herein. This document does not imply or express copyright licenses granted hereunder to design or fabricate any integrated circuits. The products must not be used within any Life Support System without the specific written consent of Energy Micro. A "Life Support System" is any product or system intended to support or sustain life and/or health, which, if it fails, can be reasonably expected to result in significant personal injury or death. Energy Micro products are generally not intended for military applications. Energy Micro products shall under no circumstances be used in weapons of mass destruction including (but not limited to) nuclear, biological or chemical weapons, or missiles capable of delivering such weapons.

A.2 Trademark Information

Energy Micro, EFM32, EFR, logo and combinations thereof, and others are the registered trademarks or trademarks of Energy Micro AS. ARM, CORTEX, THUMB are the registered trademarks of ARM Limited. Other terms and product names may be trademarks of others.

B Contact Information

B.1 Energy Micro Corporate Headquarters

Postal Address	Visitor Address	Technical Support
Energy Micro AS P.O. Box 4633 Nydalen N-0405 Oslo NORWAY	Energy Micro AS Sandakerveien 118 N-0484 Oslo NORWAY	support.energymicro.com Phone: +47 40 10 03 01

www.energymicro.com

Phone: +47 23 00 98 00

Fax: + 47 23 00 98 01

B.2 Global Contacts

Visit **www.energymicro.com** for information on global distributors and representatives or contact **sales@energymicro.com** for additional information.

Americas	Europe, Middle East and Africa	Asia and Pacific
www.energymicro.com/americas	www.energymicro.com/emea	www.energymicro.com/asia

Table of Contents

1. Ordering Information	2
2. System Summary	3
2.1. System Introduction	3
2.2. Configuration Summary	7
2.3. Memory Map	9
3. Electrical Characteristics	10
3.1. Test Conditions	10
3.2. Absolute Maximum Ratings	10
3.3. General Operating Conditions	10
3.4. Current Consumption	12
3.5. Transition between Energy Modes	13
3.6. Power Management	13
3.7. Flash	14
3.8. General Purpose Input Output	15
3.9. Oscillators	22
3.10. Analog Digital Converter (ADC)	26
3.11. Digital Analog Converter (DAC)	36
3.12. Operational Amplifier (OPAMP)	37
3.13. Analog Comparator (ACMP)	41
3.14. Voltage Comparator (VCMP)	43
3.15. LCD	44
3.16. Digital Peripherals	44
4. Pinout and Package	46
4.1. Pinout	46
4.2. Alternate functionality pinout	51
4.3. GPIO pinout overview	58
4.4. Opamp pinout overview	59
4.5. BGA120 Package	60
5. PCB Layout and Soldering	61
5.1. Recommended PCB Layout	61
5.2. Soldering Information	63
6. Chip Marking, Revision and Errata	64
6.1. Chip Marking	64
6.2. Revision	64
6.3. Errata	64
7. Revision History	65
7.1. Revision 1.00	65
7.2. Revision 0.92	65
7.3. Revision 0.90	65
A. Disclaimer and Trademarks	66
A.1. Disclaimer	66
A.2. Trademark Information	66
B. Contact Information	67
B.1. Energy Micro Corporate Headquarters	67
B.2. Global Contacts	67

List of Figures

2.1. Block Diagram	3
2.2. EFM32LG995 Memory Map with largest RAM and Flash sizes	9
3.1. Typical Low-Level Output Current, 2V Supply Voltage	16
3.2. Typical High-Level Output Current, 2V Supply Voltage	17
3.3. Typical Low-Level Output Current, 3V Supply Voltage	18
3.4. Typical High-Level Output Current, 3V Supply Voltage	19
3.5. Typical Low-Level Output Current, 3.8V Supply Voltage	20
3.6. Typical High-Level Output Current, 3.8V Supply Voltage	21
3.7. Minimum Load Capacitance (C_{LFXOL}) Requirement For Safe Crystal Startup	22
3.8. Calibrated LFRCO Frequency vs Temperature and Supply Voltage	24
3.9. Calibrated HFRCO 11 MHz Band Frequency vs Temperature and Supply Voltage	25
3.10. Calibrated HFRCO 14 MHz Band Frequency vs Temperature and Supply Voltage	25
3.11. Calibrated HFRCO 21 MHz Band Frequency vs Temperature and Supply Voltage	25
3.12. Calibrated HFRCO 28 MHz Band Frequency vs Temperature and Supply Voltage	26
3.13. Integral Non-Linearity (INL)	30
3.14. Differential Non-Linearity (DNL)	31
3.15. ADC Frequency Spectrum, Vdd = 3V, Temp = 25°	32
3.16. ADC Integral Linearity Error vs Code, Vdd = 3V, Temp = 25°	33
3.17. ADC Differential Linearity Error vs Code, Vdd = 3V, Temp = 25°	34
3.18. ADC Absolute Offset, Common Mode = Vdd / 2	35
3.19. ADC Dynamic Performance vs Temperature for all ADC References, Vdd = 3V	35
3.20. ADC Temperature sensor readout	36
3.21. OPAMP Common Mode Rejection Ratio	39
3.22. OPAMP Positive Power Supply Rejection Ratio	39
3.23. OPAMP Negative Power Supply Rejection Ratio	40
3.24. OPAMP Voltage Noise Spectral Density (Unity Gain) $V_{out}=1V$	40
3.25. OPAMP Voltage Noise Spectral Density (Non-Unity Gain)	40
3.26. Typical ACMP Characteristics	42
4.1. EFM32LG995 Pinout (top view, not to scale)	46
4.2. Opamp Pinout	59
4.3. BGA120	60
5.1. BGA120 PCB Land Pattern	61
5.2. BGA120 PCB Solder Mask	62
5.3. BGA120 PCB Stencil Design	63
6.1. Example Chip Marking	64

List of Tables

1.1. Ordering Information	2
2.1. Configuration Summary	7
3.1. Absolute Maximum Ratings	10
3.2. General Operating Conditions	10
3.3. Environmental	11
3.4. Current Consumption	12
3.5. Energy Modes Transitions	13
3.6. Power Management	13
3.7. Flash	14
3.8. GPIO	15
3.9. LFXO	22
3.10. Minimum Load Capacitance (C_{LFXOL}) Requirement For Safe Crystal Startup	23
3.11. HFXO	23
3.12. LFRCO	23
3.13. HFRCO	24
3.14. ULFRCO	26
3.15. ADC	26
3.16. DAC	36
3.17. OPAMP	37
3.18. ACMP	41
3.19. VCMP	43
3.20. LCD	44
3.21. Digital Peripherals	44
4.1. Device Pinout	46
4.2. Alternate functionality overview	51
4.3. GPIO Pinout	59
5.1. BGA120 PCB Land Pattern Dimensions (Dimensions in mm)	61
5.2. BGA120 PCB Solder Mask Dimensions (Dimensions in mm)	62
5.3. BGA120 PCB Stencil Design Dimensions (Dimensions in mm)	63

List of Equations

3.1. Total ACMP Active Current	41
3.2. VCMP Trigger Level as a Function of Level Setting	43
3.3. Total LCD Current Based on Operational Mode and Internal Boost	44



Energy Micro AS, Sandakerveien 118, P.O. Box 4633 Nydalen, N-0405 Oslo, Norway - www.energymicro.com