

LM3532

High Efficiency White LED Driver with Programmable Ambient Light Sensing Capability and I²C-Compatible Interface

General Description

The LM3532 is a 500 kHz fixed frequency asynchronous boost converter which provides the power for 3 high-voltage, low-side current sinks. The device is programmable over an I²C-compatible interface and has independent current control for all three channels. The adaptive current regulation method allows for different LED currents in each current sink thus allowing for a wide variety of backlight + keypad applications.

The main features of the LM3532 include dual ambient light sensor inputs each with 32 internal voltage setting resistors, 8-bit logarithmic and linear brightness control, dual external PWM brightness control inputs, and up to 1000:1 dimming ratio with programmable fade in and fade out settings.

The LM3532 is available in a 16-bump, 0.4mm pitch thin micro SMD (1.745 mm x 1.845 mm x 0.6 mm). The device operates over a 2.7V to 5.5V input voltage range and the -40°C to +85°C temperature range.

Features

- Drives up to 3 Parallel High-Voltage LED Strings at 40V each with up to 90% efficiency
- 0.4% Typical Current Matching Between Strings
- 256 Level Logarithmic and Linear Brightness Control with 14-Bit Equivalent Dimming
- I²C-compatible Interface
- Direct Read Back of Ambient Light Sensor via 8-bit ADC
- Programmable Dual Ambient Light Sensor Inputs with Internal Sensor Gain Selection
- Dual External PWM Inputs for LED Brightness Adjustment
- Independent Current String Brightness Control
- Programmable LED Current Ramp Rates
- 40V Over-Voltage Protection
- 1A Typical Current Limit

Applications

- Power Source for White LED Backlit LCD Displays
- Programmable Keypad Backlight

Typical Application Circuit

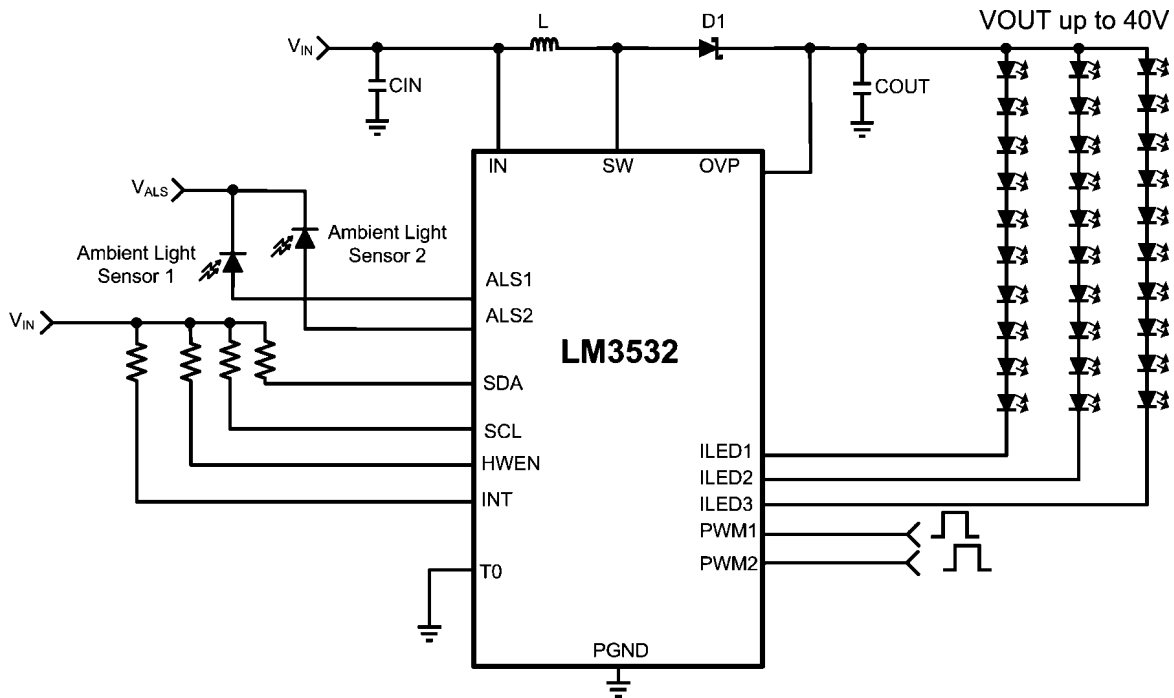

301154100

Application Circuit Component List

Component	Manufacturer's Part Number	Value	Package Designator	Size (mm)	Current/Voltage Rating (Resistance)
White LED Driver	National Semiconductor LM3532		TMD16FKA	1.745 mm x 1.845 mm x 0.6 mm	
L	COILCRAFT LPS4018-103ML	10 μ H		3.9 mm x 3.9 mm x 1.7 mm	1A ($R_{DC} = 0.2\Omega$)
COUT	Murata GRM21BR71H105KA12L	1 μ F	0805	0805	50V
CIN	Murata GRM188R71A225KE15D	2.2 μ F	0603	0603	10V

Connection Diagram

Top View

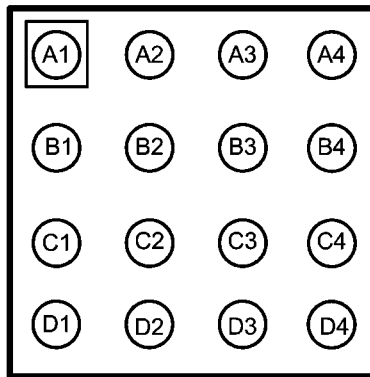

30115402
16-Bump (1.745 mm x 1.845 mm x 0.6 mm)
micro SMD Package TMD16FKA

Ordering Information

Order Number	Package Type	Supplied As	Lead Free?	Top Mark (2 lines: first line (XX) is date code and die run code, second line is voltage option)
LM3532TME-40A NOPB	16-Bump micro SMD	250 units, Tape-and-Reel, No Lead	Yes	XX D34
LM3532TMX-40A NOPB	16-Bump micro SMD	3000 units, Tape-and-Reel, No Lead	Yes	XX D34

Pin Descriptions/Functions

Pin	Name	Description
A1	OVP	Output Voltage Sense Connection for Over Voltage Sensing. Connect OVP to the positive terminal of the output capacitor.
A2	ILED3	Input Terminal to High Voltage Current Sink #3 (40V max). The boost converter regulates the minimum of ILED1, ILED2, or ILED3 to 0.4V.
A3	ILED2	Input Terminal to High Voltage Current Sink #2 (40V max). The boost converter regulates the minimum of ILED1, ILED2, or ILED3 to 0.4V.
A4	ILED1	Input Terminal to High Voltage Current Sink #1 (40V max). The boost converter regulates the minimum of ILED1, ILED2, or ILED3 to 0.4V.
B1	ALS1	Ambient Light Sensor Input 1.
B2	ALS2	Ambient Light Sensor Input 2.
B3	HWEN	Active High Hardware Enable. Pull this pin high to enable the LM3532. HWEN is a high impedance input.
B4	IN	Input Voltage Connection. Bypass IN to GND with a minimum 2.2 μ F ceramic capacitor.
C1	PWM2	External PWM Brightness Control Input 2.
C2	PWM1	External PWM Brightness Control Input 1.
C3	INT	Programmable Interrupt Pin. INT is an open drain output that pulls low when the ALS changes zones.
C4	GND	Ground
D1	SDA	Serial Data Connection for I ² C-Compatible Interface
D2	SCL	Serial Clock Connection for I ² C-Compatible Interface
D3	T0	Unused test input. This pin must be tied externally to GND for proper operation.
D4	SW	Drain Connection for boost converters internal NFET

Absolute Maximum Ratings *(Note 1, Note 2)*

2)

If Military/Aerospace specified devices are required, please contact the National Semiconductor Sales Office/Distributors for availability and specifications.

V_{IN} to GND	-0.3V to +6V
V_{SW} , V_{OVP} , V_{ILED1} , V_{ILED2} , V_{ILED3} to GND	-0.3V to +45V
V_{SCL} , V_{SDA} , V_{ALS1} , V_{ALS2} , V_{PWM1} , V_{PWM2} , V_{INT} , V_{HWEN} , V_{T0} to GND	-0.3V to +6V
Continuous Power Dissipation	Internally Limited
Junction Temperature (T_{J-MAX})	+150°C
Storage Temperature Range	-65°C to +150°C
Maximum Lead Temperature (Soldering, 10s) <i>(Note 3)</i>	+300°C
ESD Rating	
Human Body Model <i>(Note 9)</i>	2.0 kV

Electrical Characteristics *(Note 2, Note 7)*

Limits in standard type face are for $T_A = +25^\circ\text{C}$ and those in **boldface type** apply over the full operating ambient temperature range ($-30^\circ\text{C} \leq T_A \leq +85^\circ\text{C}$). Unless otherwise specified $V_{IN} = 3.6\text{V}$.

Symbol	Parameter	Conditions	Min	Typ	Max	Units
$I_{LED(1/2/3)}$	Output Current Regulation Accuracy (ILED1, ILED2 or ILED3)	$2.7\text{V} \leq V_{IN} \leq 5.5\text{V}$, ControlX Full-Scale Current Register = 0xF3, Brightness Code = 0xFF	18.68	20.2	21.8	mA
I_{MATCH} <i>(Note 10)</i> , <i>(Note 11)</i>	ILED2 to ILED3 Current Matching	$2.7\text{V} \leq V_{IN} \leq 5.5\text{V}$	-2	0.3	2	%
V_{REG_CS}	Regulated Current Sink Headroom Voltage			400		mV
V_{HR}	Current Sink Minimum Headroom Voltage	$I_{LED} = 95\%$ of nominal, $I_{LED} = 20.2\text{mA}$		200	240	mV
R_{DSON}	NMOS Switch On Resistance	$I_{SW} = 100\text{mA}$		0.25		Ω
I_{CL}	NMOS Switch Current Limit	$2.7\text{V} \leq V_{IN} \leq 5.5\text{V}$	880	1000	1120	mA
V_{OVP}	Output Over-Voltage Protection	ON Threshold, $2.7\text{V} \leq V_{IN} \leq 5.5\text{V}$	40	41	42	V
		Hysteresis		1		
f_{SW}	Switching Frequency	$2.7\text{V} \leq V_{IN} \leq 5.5\text{V}$	450	500	550	kHz
D_{MAX}	Maximum Duty Cycle			94		%
D_{MIN}	Minimum Duty Cycle			10		%
I_Q	Quiescent Current into IN, Device Not Switching	$I_{LED1} = I_{LED2} = I_{LED3} = 20.2\text{mA}$, feedback disabled.		490		μA
I_{Q_SW}	Switching Supply Current	$I_{LED1} = I_{LED2} = I_{LED3} = 20\text{mA}$, $V_{OUT} = 32\text{V}$		1.35		mA
I_{SHDN}	Shutdown Current	$2.7\text{V} \leq V_{IN} \leq 5.5\text{V}$, HWEN = GND		1	2	μA
I_{LED_MIN}	Minimum LED Current in ILED1, ILED2 or ILED3	Full-Scale Current = 20.2 mA Brightness code = 0x01, Mapping = Exponential		9.5		μA
T_{SD}	Thermal Shutdown			+140		°C
	Hysteresis			15		

LOGIC INPUTS/OUTPUTS (PWM1, PWM2, HWEN, SCL, SDA, INT)

V_{IL}	Input Logic Low	$2.7\text{V} \leq V_{IN} \leq 5.5\text{V}$	0		0.4	V
V_{IH}	Input Logic High	$2.7\text{V} \leq V_{IN} \leq 5.5\text{V}$	1.2		V_{IN}	

Operating Ratings *(Note 1, Note 2)*

V_{IN} to GND	2.7V to 5.5V
V_{SW} , V_{OVP} , V_{ILED1} , V_{ILED2} , V_{ILED3} to GND	0 to +40V
Junction Temperature Range (T_J) <i>(Note 4, Note 5)</i>	-40°C to +125°C

Thermal Properties

Thermal Resistance Junction to Ambient (T_{JA}) <i>(Note 6)</i>	61.3°C/W
---	----------

ESD Caution Notice

National Semiconductor recommends that all integrated circuits be handled with appropriate ESD precautions. Failure to observe proper ESD handling techniques can result in damage to the device.

Symbol	Parameter	Conditions	Min	Typ	Max	Units
V_{OL}	Output Logic Low (SCL, INT)	$2.7V \leq V_{IN} \leq 5.5V, I_{LOAD} = 3mA$			0.4	V
R_{PWM}	PWM Input Internal Pulldown Resistance (PWM1, PWM2)			100		k Ω
PC-COMPATIBLE TIMING SPECIFICATIONS (SCL, SDA, see)						
t_1	SCL (Clock Period)		2.5			μs
t_2	Data In Setup Time to SCL High		100			ns
t_3	Data Out Stable After SCL Low		0			ns
t_4	SDA Low Setup Time to SCL Low (Start)		100			ns
t_5	SDA High Hold Time After SCL High (Stop)		100			ns
AMBIENT LIGHT SENSOR INPUTS (ALS1, ALS2)						
R_{ALS1}, R_{ALS2}	ALS Pin Internal Pulldown Resistors	ALS1, ALS2 Resistor Select Register = 0x0F, $2.7V \leq V_{IN} \leq 5.5V$	2.29	2.44	2.59	k Ω
V_{ALS_REF}	Ambient Light Sensor Reference Voltage	$2.7V \leq V_{IN} \leq 5.5V$	1.94	2	2.06	V
V_{OS}	ALS Input Offset Voltage (Code 0 to 1 transition - V_{LSB})	$2.7V \leq V_{IN} \leq 5.5V$	0.8	2.5	4.2	mV
t_{CONV}	Conversion Time				154	μs
LSB	ADC Resolution	$2.7V \leq V_{IN} \leq 5.5V$		7.84		mV

Note 1: Absolute Maximum Ratings are limits beyond which damage to the device may occur. Operating Ratings are conditions for which the device is intended to be functional, but device parameter specifications may not be guaranteed. For guaranteed specifications and test conditions, see the Electrical Characteristics table.

Note 2: All voltages are with respect to the potential at the GND pin.

Note 3: For detailed soldering specifications and information, please refer to National Semiconductor Application Note 1112: Micro SMD Wafer Level Chip Scale Package (AN-1112), available at www.national.com.

Note 4: Internal thermal shutdown circuitry protects the device from permanent damage. Thermal shutdown engages at $T_J=+140^{\circ}\text{C}$ (typ.) and disengages at $T_J=+125^{\circ}\text{C}$ (typ.).

Note 5: In applications where high power dissipation and/or poor package thermal resistance is present, the maximum ambient temperature may have to be derated. Maximum ambient temperature (T_{A-MAX}) is dependent on the maximum operating junction temperature ($T_{J-MAX-OP} = +125^{\circ}\text{C}$), the maximum power dissipation of the device in the application (P_{D-MAX}), and the junction-to ambient thermal resistance of the part/package in the application (θ_{JA}), as given by the following equation: $T_{A-MAX} = T_{J-MAX-OP} - (\theta_{JA} \times P_{D-MAX})$.

Note 6: Junction-to-ambient thermal resistance (θ_{JA}) is taken from a thermal modeling result, performed under the conditions and guidelines set forth in the JEDEC standard JESD51-7. The test board is a 4-layer FR-4 board measuring 102 mm x 76 mm x 1.6 mm with a 2 x 1 array of thermal vias. The ground plane on the board is 50 mm x 50 mm. Thickness of copper layers are 36 μm /18 μm /18 μm /36 μm (1.5 oz/1oz/1oz/1.5 oz). Ambient temperature in simulation is 22°C in still air. Power dissipation is 1W. The value of θ_{JA} of this product in the micro SMD package could fall in a range as wide as 60°C/W to 110°C/W (if not wider), depending on PCB material, layout, and environmental conditions. In applications where high maximum power dissipation exists special care must be paid to thermal dissipation issues.

Note 7: Min and Max limits are guaranteed by design, test, or statistical analysis. Typical numbers are not guaranteed, but do represent the most likely norm. Unless otherwise specified, conditions for typical specifications are: $V_{IN} = 3.6\text{V}$ and $T_A = +25^{\circ}\text{C}$.

Note 8: SCL and SDA must be glitch-free in order for proper brightness control to be realized.

Note 9: The human body model is a 100 pF capacitor discharged through 1.5 k Ω resistor into each pin. (MIL-STD-883 3015.7).

Note 10: All Current sinks for the matching spec are assigned to the same Control Bank.

Note 11: Matching is determined by the following formula: $2 \times (ILED2 - ILED3)/(ILED2 + ILED3)$.

Typical Performance Characteristics $V_{IN} = 3.6V$, LEDs ($V_F = 3.2V @ 20\text{mA}$, $T_A = 25^\circ\text{C}$), $C_{OUT} = 1\mu\text{F}$, $C_{IN} = 2.2\mu\text{F}$, L = Coilcraft LPS4018 (10 μH or 22 μH), $T_A = +25^\circ\text{C}$ unless otherwise specified.

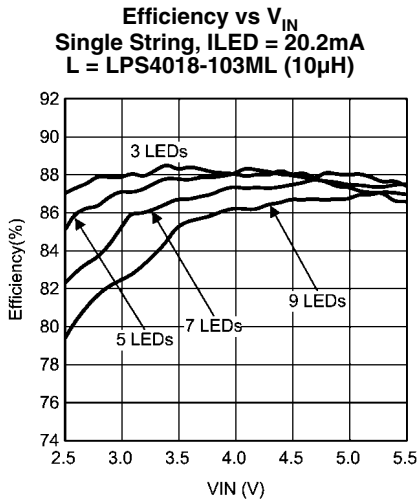

30115451

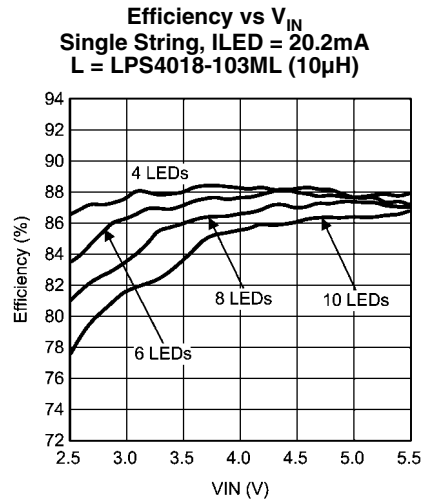

30115452

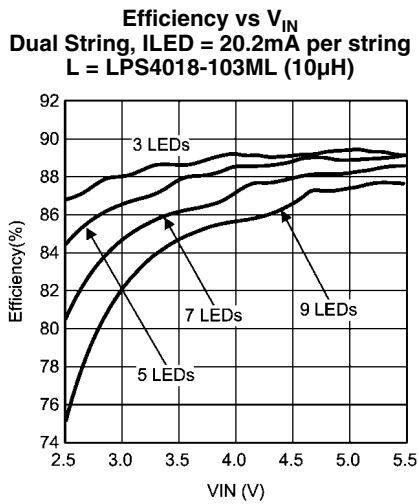

30115453

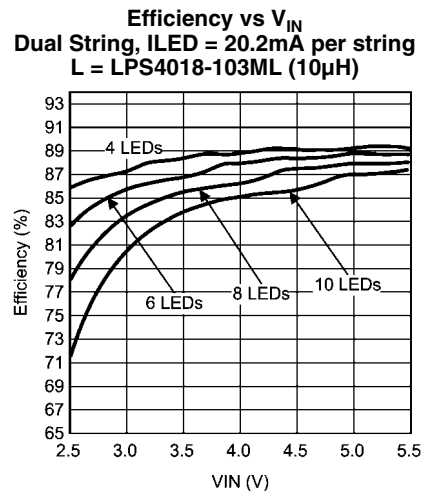

30115454

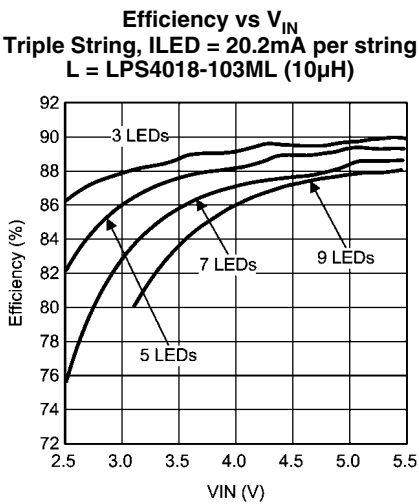

30115455

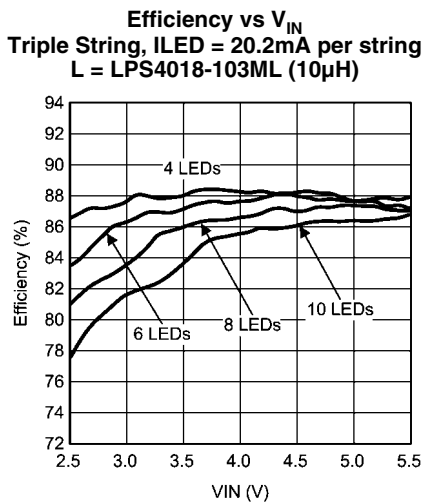

30115456

Efficiency vs V_{IN}
 Single String, ILED = 20.2mA per string
 L = LPS4018-223ML (22 μ H)

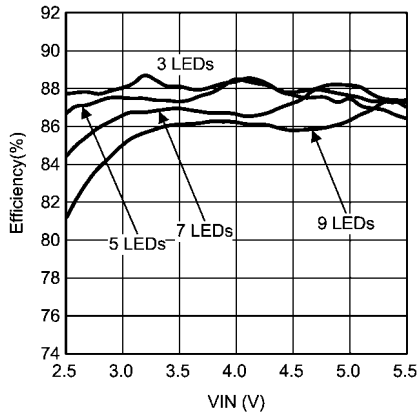

30115457

Efficiency vs V_{IN}
 Single String, ILED = 20.2mA per string
 L = LPS4018-223ML (22 μ H)

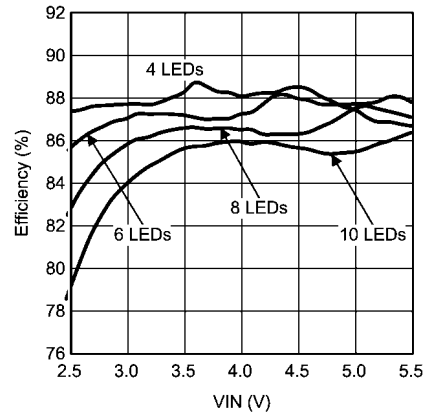

30115458

Efficiency vs V_{IN}
 Dual String, ILED = 20.2mA per string
 L = LPS4018-223ML (22 μ H)

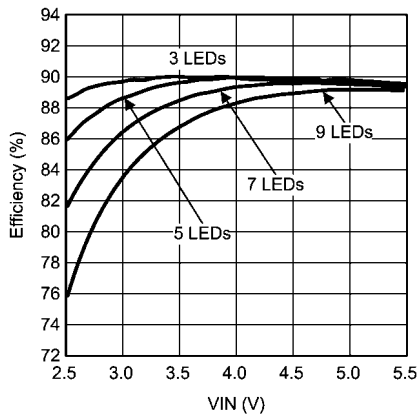

30115459

Efficiency vs V_{IN}
 Dual String, ILED = 20.2mA per string
 L = LPS4018-223ML (22 μ H)

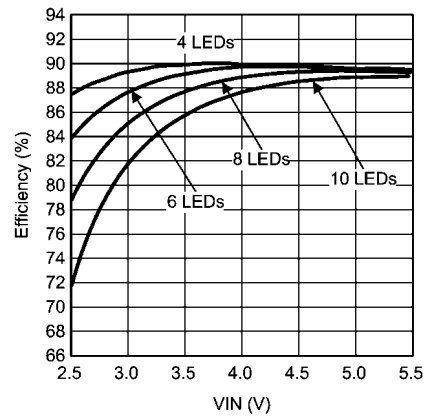

30115460

Efficiency vs V_{IN}
 Triple String, ILED = 20.2mA per string
 L = LPS4018-223ML (22 μ H)

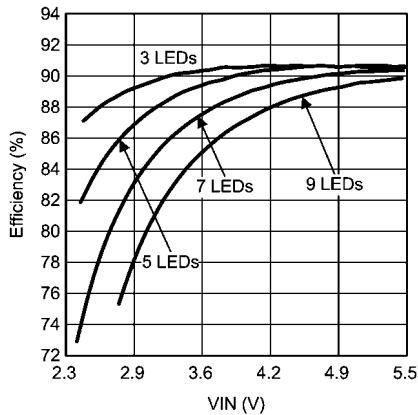

30115461

Efficiency vs V_{IN}
 Triple String, ILED = 20.2mA per string
 L = LPS4018-223ML (22 μ H)

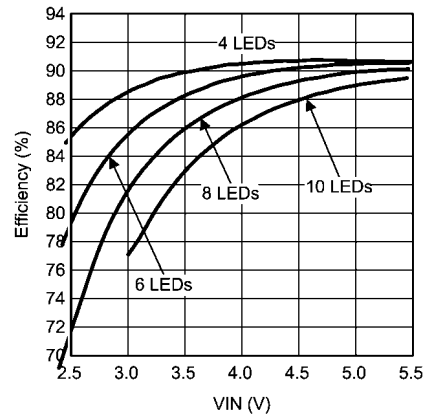

30115462

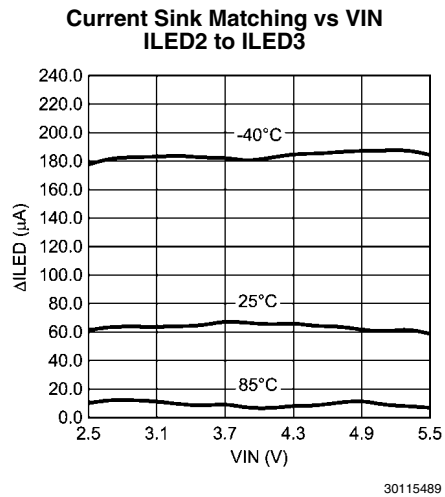
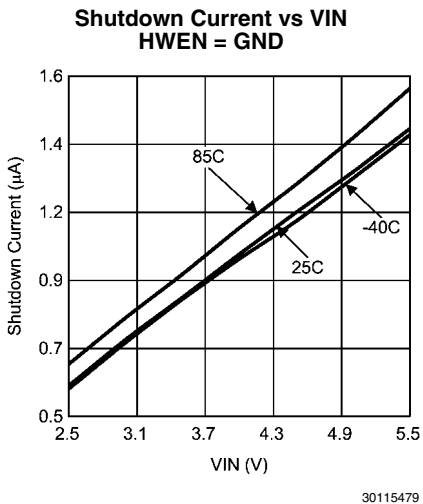
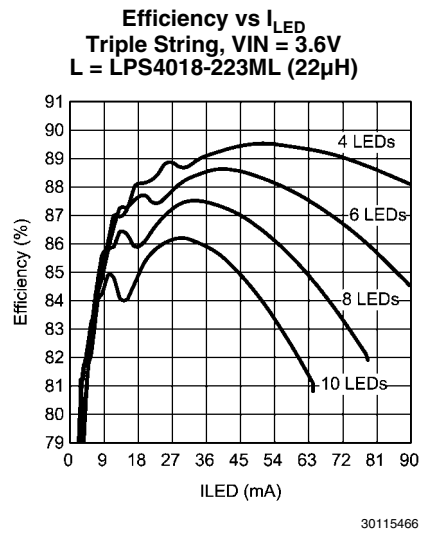
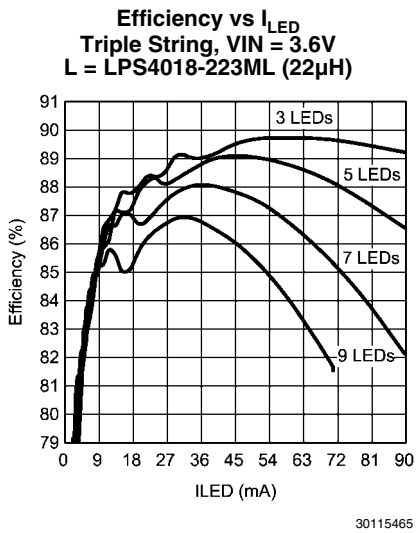
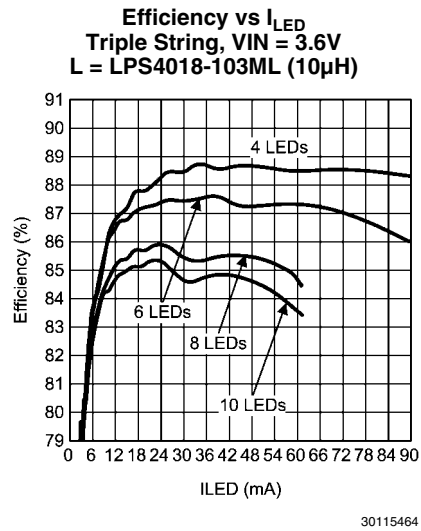
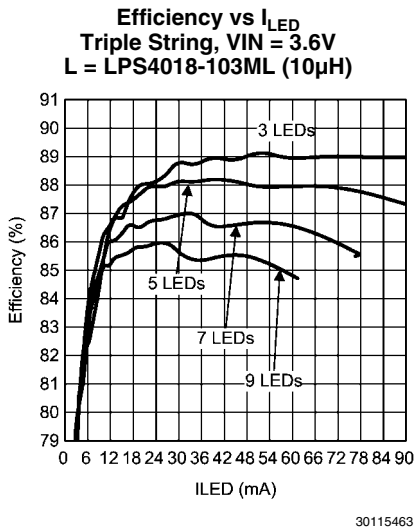

Current Sink Matching vs VIN
ILED1 to ILED2 to ILED3
(Δ ILED is worst case difference between all three strings)

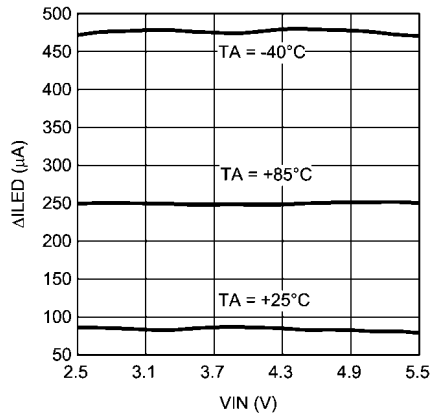

30115482

ALS Resistance vs VIN
 R_{ALS1} , (2.44k Ω setting)

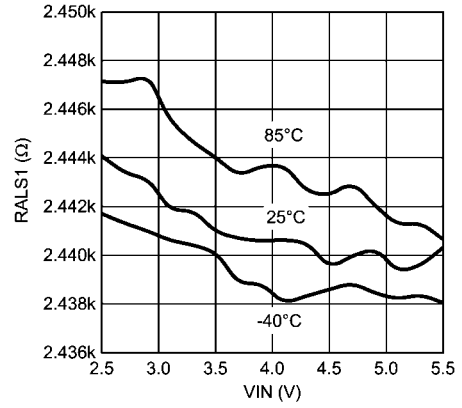

30115478

ALS Resistor Matching vs VIN
(2.44k Ω setting)

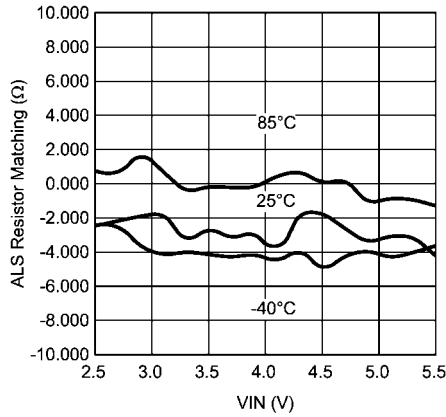

30115480

Integral Non Linearity vs Code
(Endpoint Method)

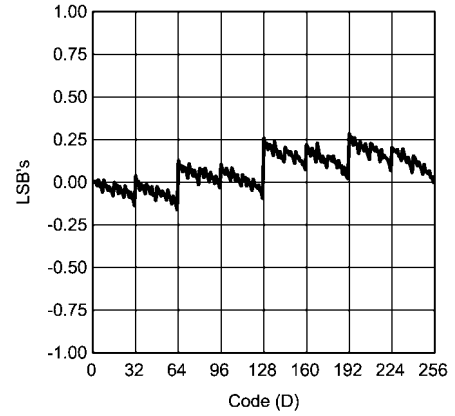

30115476

Differential Non Linearity vs Code

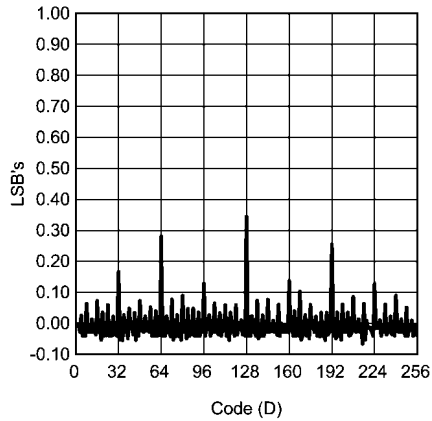

30115477

Peak to Peak LED Current Ripple vs f_{PWM}

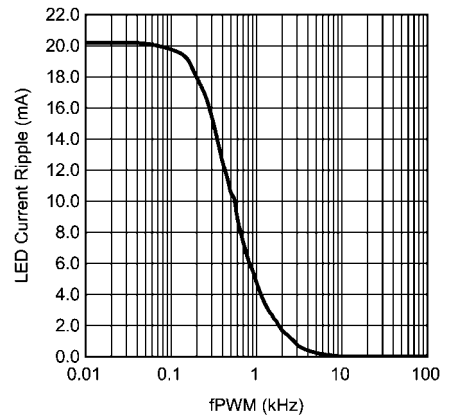

30115490

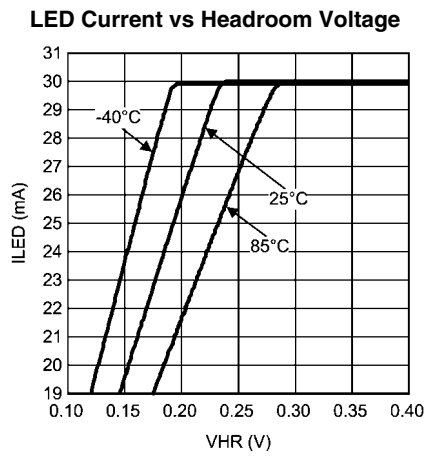

30115473

Operational Description

40V BOOST CONVERTER

The LM3532 contains a 40V maximum output voltage, asynchronous boost converter with an integrated 250 mΩ switch and three low-side current sinks. Each low-side current sink is independently programmable from 0 to 30 mA.

HARDWARE ENABLE INPUT

HWEN is the LM3532's global hardware enable input. This pin must be driven high to enable the device. HWEN is a high-impedance input so cannot be left floating. Typically HWEN would be connected through a pullup resistor to the logic supply voltage or driven high from a micro controller. Driving HWEN low will place the LM3532 into a low-current shutdown state and force all the internal registers to their power on reset (POR) states.

FEEDBACK ENABLE

Each current sink can be set for feedback enable or feedback disable. When feedback is enabled, the boost converter main-

tains at least 400 mV across each active current sink. This causes the boost output voltage (VOUT) to raise up or down depending on how many LEDs are placed in series in the highest voltage string. This ensures there is a minimum headroom voltage across each current sink. The potential drawback is that for large differentials in LED counts between strings, the LED voltage can be drastically different causing the excess voltage in the lower LED string to be dropped across its current sink. In situations where there are other voltage sources available, or where the LED count is low enough to use VIN as the power source, the feedback can be disabled on the specific current sink. This allows for the current sink to be active, but eliminates its control over the boost output voltage (see [Figure 1](#)). In this situation care must be taken to ensure there is always at least 400 mV of headroom voltage across each active current sink to avoid the current from going out of regulation. Control over the feedback enable/disable is programmable via the Feedback Enable Register (see [Table 13](#)).

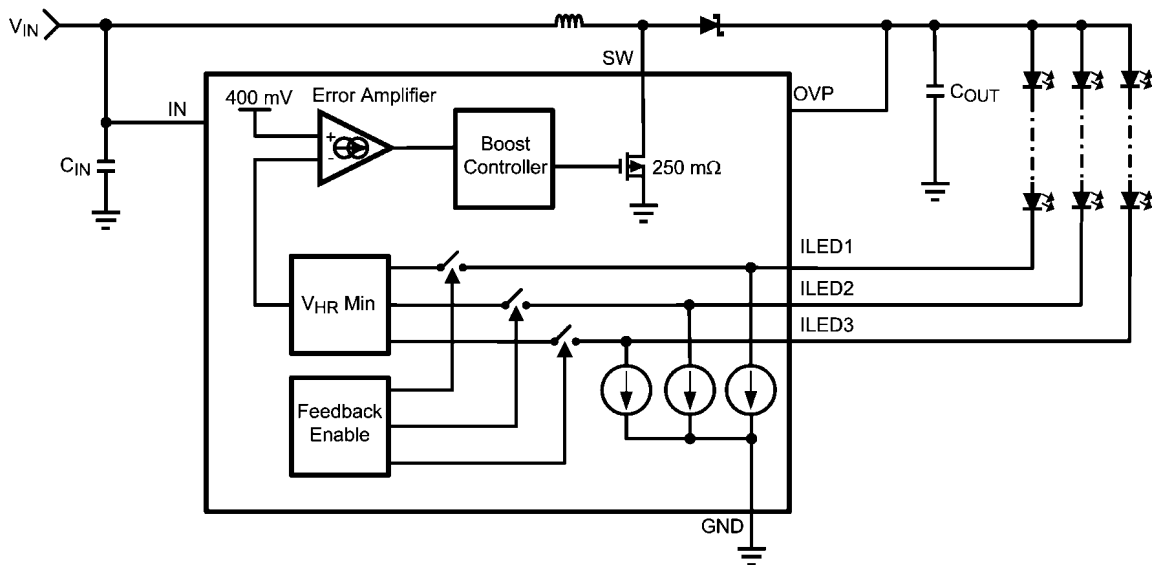

30115437

FIGURE 1. LM3532 Feedback Enable/Disable

LM3532 CURRENT SINK CONFIGURATION

Control of the LM3532's three current sinks is done by configuring the three internal control banks (Control A, Control B, and Control C) (see [Figure 2](#)). Any of the current sinks (ILED1,

ILED2, or ILED3) can be mapped to any of the three control banks. Configuration of the control banks is done via the Output Configuration register.

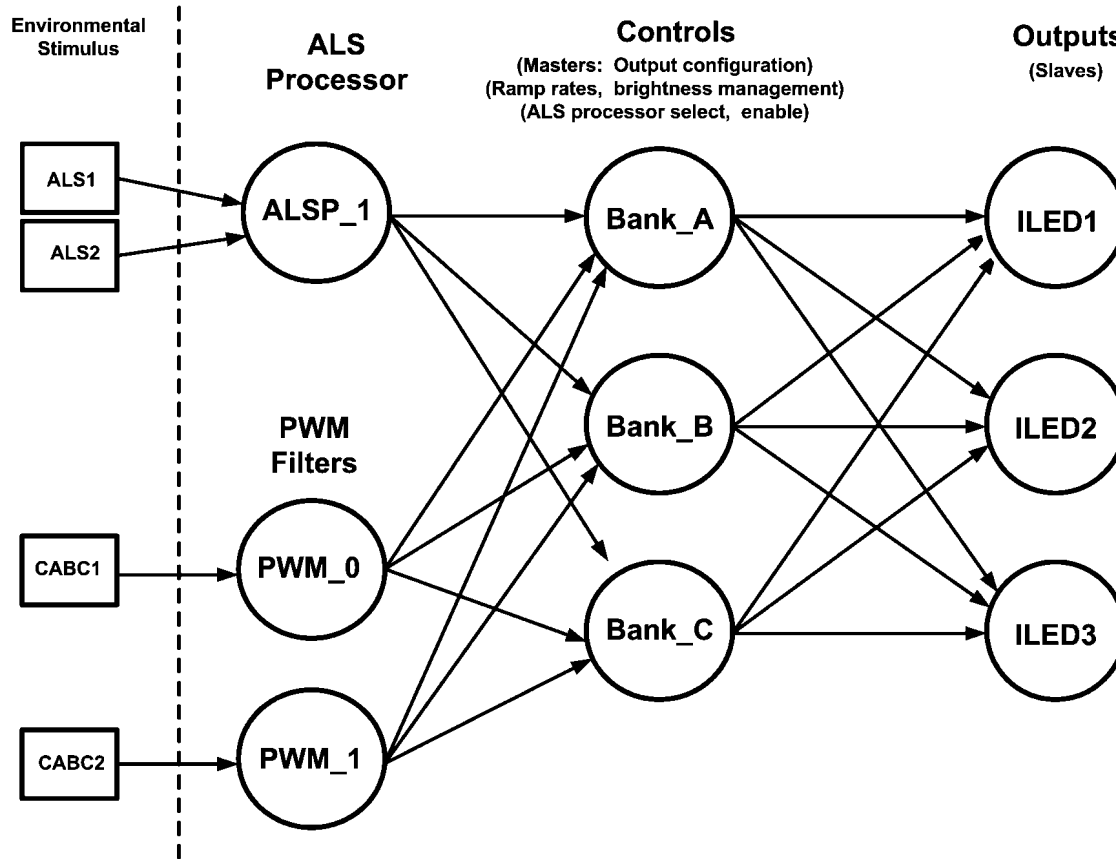

30115414

FIGURE 2. LM3532 Functional Control Diagram

PWM INPUTS

The LM3532 provides two PWM inputs (PWM1 and PWM2) which can be mapped to any of the three Control Banks. PWM input mapping is done through the Control A PWM Configuration register, the Control B PWM Configuration register, and the Control C PWM Configuration register.

Both PWM inputs (PWM1 and PWM2) feed into internal level shifters and lowpass filters. This allows the PWM inputs to accept logic level signals and convert them to analog control signals which can control the assigned Control Banks LED current. The internal lowpass filter at each PWM input has a typical corner frequency of 540 Hz with a Q of 0.5. This gives a low end useful PWM frequency of around 2kHz. Frequencies lower than this will cause the LED current to show larger ripple and result in non-linear behavior vs. duty cycle due to

the response time of the boost circuit. The upper boundary of the PWM frequency is greater than 100 kHz. Frequencies above 200 kHz will begin to show non linear behavior due to propagation delays through the PWM input circuitry.

FULL-SCALE LED CURRENT

There are 32 programmable full-scale current settings for each of the three control banks (Control A, Control B, and Control C). Each control bank has its own independent full-scale current setting ($I_{LED_FULL_SCALE}$). Full-scale current for the respective Control Bank is set via the Control A Full-Scale Current Register, the Control B Full-Scale Current Register, and the Control C Full-Scale Current Register (see [Table 12](#)).

LED CURRENT RAMPING

The LM3532 provides 4 methods to control the rate of rise or fall of the LED current during these events:

1. Startup from 0 to the initial target
2. Shutdown
3. Ramp up from one brightness level to the next
4. Ramp down from one brightness level to the next

See [Table 4](#) and [Table 5](#).

STARTUP AND SHUTDOWN CURRENT RAMPING

The startup and shutdown ramp rates are independently programmable in the startup/Shutdown Ramp Rate Register (see [Table 4](#)). There are 8 different startup and 8 different shutdown ramp rates. The startup ramp rates are independently programmable from the shutdown ramp rates, but not independently programmable for each Control Bank. For example, programming a startup or shutdown ramp rate, programs the same ramp rate for each Control Bank.

RUN TIME RAMP RATES

Current ramping from one brightness level to the next is programmed via the Run Time Ramp Rate Register (see [Table 5](#)). There are 8 different ramp-up and 8 different ramp-down rates. The ramp-up rate is independently programmable from the ramp-down rate, but not independently programmable for each Control Bank. For example, programming a ramp-up or

a ramp-down rate programs the same rate for each Control Bank.

LED CURRENT MAPPING MODES

All LED current brightness codes are 8 bits (256 different levels), where each bit represents a percentage of the programmed full-scale current setting for that particular Control Bank. The percentage of the full-scale current is different depending on which mapping mode is selected. The mapping mode can be either exponential or linear. Mapping mode is selected via bit [1] of the Control A, B, or C Brightness Configuration Registers.

EXPONENTIAL CURRENT MAPPING MODE

In exponential mapping mode, the backlight code to LED current approximates the following equation:

$$I_{LED} = I_{LED_FULLSCALE} \times 0.85^{\left[40 - \left(\frac{Code+1}{6.4}\right)\right]} \times D_{PWM}$$

where Code is the 8-bit code in the programmed brightness register and D_{PWM} is the duty cycle of the PWM input that is assigned to the particular control bank. For the exponential mapped mode ([Figure 3](#)) shows the typical response of % full-scale current setting vs 8-bit brightness code.

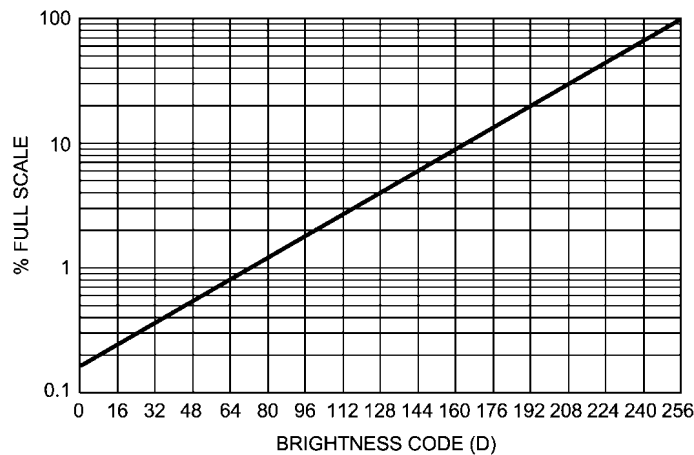

30115493

FIGURE 3. Exponential Mapping Response

LINEAR CURRENT MAPPING

In linear mapping mode the backlight code to LED current approximates the following equation:

$$I_{LED} = I_{LED_FULLSCALE} \times \frac{1}{255} \times \text{Code} \times D_{PWM}$$

where Code is the 8-bit code in the programmed brightness register and DPWM is the duty cycle of the PWM input that is assigned to the particular control bank. For the linear mapped mode (*Figure 4*) shows the typical response of % full-scale current setting vs 8-bit brightness code.

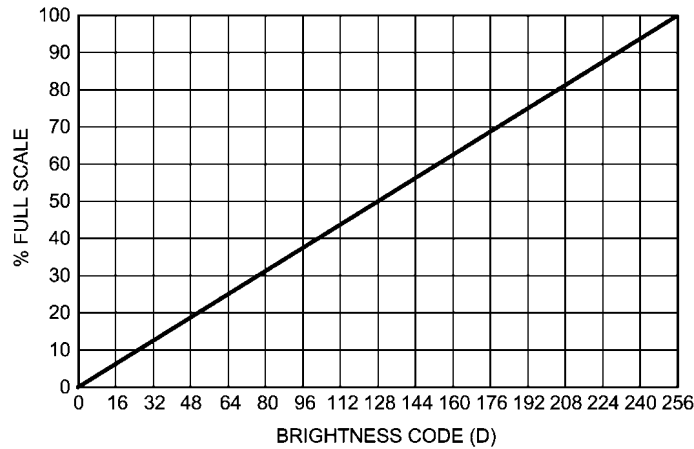

30115494

FIGURE 4. Linear Mapping Response

LED CURRENT CONTROL

Once the Full-Scale Current is set, control of the LM3532's LED current can be done via 2 methods:

1. I²C Current Control
2. Ambient Light Sensor Current Control

I²C current control allows for the direct control of the LED current by writing directly to the specific brightness register. In ambient light sensor current control the LED current is automatically set by the ambient light sensor interface.

I²C CURRENT CONTROL

I²C Current Control is accomplished by using one of the Zone Target Registers (for the respective Control Bank) as the brightness register. This is done via bits[4:2] of the Control (A, B, or C) Brightness Registers (see *Table 9*, *Table 10*, and *Table 11*). For example, programming bits[4:2] of the Control A Brightness Register with (000) makes the brightness register for Bank A (in I²C Current Control) the Control A Zone Target 0 Register.

I²C CURRENT CONTROL WITH PWM

I²C Current Control can also incorporate the PWM duty cycle at one of the PWM inputs (PWM1 or PWM2). In this situation

the LED current is then a function of both the code in the programmed brightness register and the duty cycle input into the assigned PWM inputs (PWM1 or PWM2).

ASSIGNING and ENABLING A PWM INPUT

To make the backlight current a function of the PWM input duty cycle, one of the PWM inputs must first be assigned to a particular Control Bank. This is done via bit [0] of the Control A, B, or C PWM Registers (see *Table 6*, *Table 7*, or *Table 8*). After assigning a PWM input to a Control Bank, the PWM input is then enabled via bits [6:2] of the Control A/B/C PWM Enable Registers. Each enable bit is associated with a specific Zone Target Register in I²C Current Control. For example, if Control A Zone Target 0 Register is configured as the brightness register, then to enable PWM for that brightness register, Control A PWM bit [2] would be set to 1.

ENABLING A CURRENT SINK

Once the brightness register and PWM inputs are configured in I²C Current Control, the current sinks assigned to the specific control bank are enabled via the Control Enable Register (see *Table 14*). *Table 1* below shows the possible configurations for Control Bank A in I²C Current Control. This table would also apply to Control Bank B and Control Bank C.

TABLE 1. I²C Current Control + PWM Bit Settings (For Control Bank A)

Current Sink Assignment	Brightness Register	PWM Select	PWM Enable	Current Sink Enable
Output Configuration Register Bits[1:0] = 00, assigns ILED1 to Control Bank A Bits[3:2] = 00 assigns ILED2 to Control Bank A Bits[5:4] = 00, assigns ILED3 to Control Bank A	Control A Brightness Configuration Register Bits [4:2] 000 selects Control A Zone Target 0 as brightness register 001 selects Control A Zone Target 1 brightness register 010 selects Control A Zone Target 2 brightness register 011 selects Control A Zone Target 3 brightness register 1XX selects Control A Zone Target 4 brightness register	Control A PWM Register Bit[0] 0 selects PWM1 1 selects PWM2	Control A PWM Register Bit[2] is PWM enable when Control A Zone Target 0 is configured as the brightness register Bit[3] is PWM enable when Control A Zone Target 1 is configured as the brightness register Bit[4] is PWM enable when Control A Zone Target 2 is configured as the brightness register Bit[5] is PWM enable when Control A Zone Target 3 is configured as the brightness register Bit[6] is PWM enable when Control A Zone Target 4 is configured as the brightness register	Control Enable Register Bit [0] 0 = Bank A Disabled 1 = Bank A Enabled

AMBIENT LIGHT SENSOR CURRENT CONTROL

In Ambient Light Sensor (ALS) Current Control the LM3532's backlight current is automatically set based upon the voltage at the ambient light sensor inputs (ALS1 and/or ALS2). These inputs are designed to connect to the outputs of analog ambient light sensors. Each ALS input has an active input voltage range of 0 to 2V.

ALS LIGHT SENSOR RESISTORS

The LM3532 offers 32 separate programmable internal resistors at the ALS1 and ALS2 inputs. These resistors take the ambient light sensor's output current and convert it into a voltage. The value of the resistor selected is typically chosen such that the ambient light sensors output voltage swing goes from 0 to 2V across the intended measured ambient light (LUX) range. The ALS resistor values are programmed via the ALS1 and ALS2 Resistor select registers (see [Table 15](#)). The code to resistor selection (assuming a 2V full-scale voltage range) is shown in the following equation:

$$R_{ALS_} = \frac{2V}{54 \mu A} \times \text{Code}$$

Each higher code in the specific ALS Resistor Select Register increases the allowed ALS sensor current by 54 μA (for a 2V

full-scale). When the ALS is disabled (ALS Configuration Register bit [3] = 0) the ALS inputs are set to a high impedance mode no matter what the ALS resistor selection is. Alternatively, ALS Resistor Select Register Code 00000 will set the specific ALS input to high impedance.

AMBIENT LIGHT ZONE BOUNDARIES

The LM3532 provides 5 ambient light brightness zones which are defined by 4 Zone Boundary Registers. The LM3532 has one set of zone boundary registers that is shared globally by all Control Banks. As the voltage at the ALS input changes in response to the ambient light sensors received light, the ALS voltage transitions through the 5 defined brightness zones. Each brightness zone can be assigned a brightness target via the 5 Zone Target registers. Each Control Bank has its own set of Zone Target registers. Therefore, in response to changes in a Brightness Zone at the ALS input, the LED current can transition to a new brightness level. This allows for backlit LCD displays to reduce the LED Current when the ambient light is dim or increase the LED current when the ambient light increases. Each Zone Boundary register is 8 bits with a full-scale voltage of 2V. This gives a $2V/255 = 7.8 \text{ mV}$ per bit. [Figure 5](#) describes the ambient light to brightness mapping.

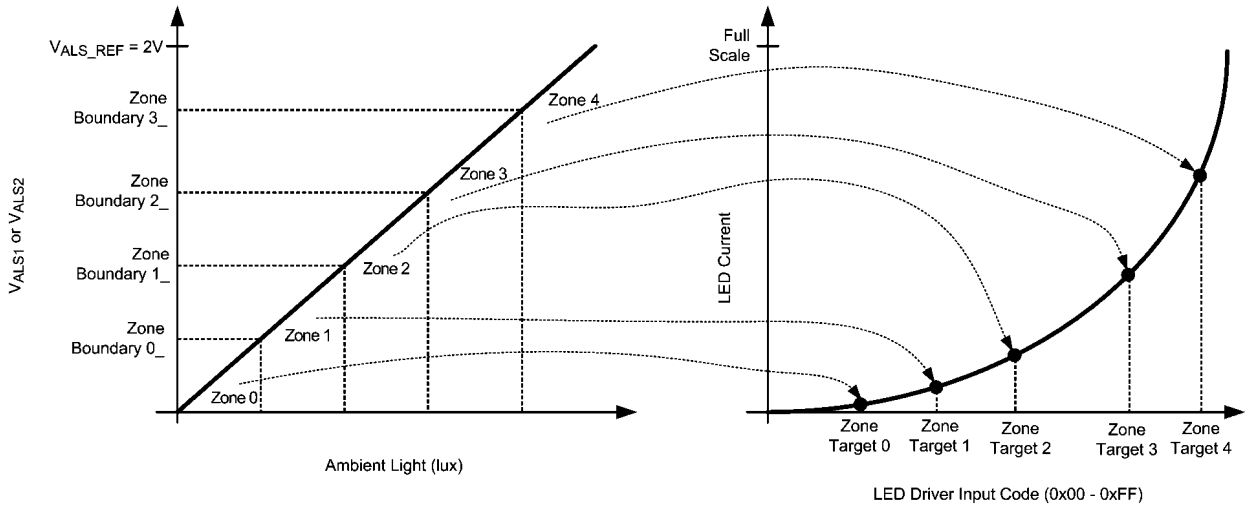

30115408

FIGURE 5. Ambient Light Input to Backlight Mapping

AMBIENT LIGHT ZONE HYSTERESIS

For each Zone Boundary there are two Zone Boundary Registers: a Zone Boundary High Register and a Zone Boundary Low Register. The difference between the Zone Boundary High and Zone Boundary Low Register set points (for a specific zone) creates the hysteresis that is required to transition

between two adjacent zones. This hysteresis prevents the backlight current from oscillating between zones when the ALS voltage is close to a Zone Boundary Threshold. Figure 6 describes this Zone Boundary Hysteresis. The arrows indicate the direction of the ALS input voltage. The black dots indicate the threshold used when transitioning to a new zone.

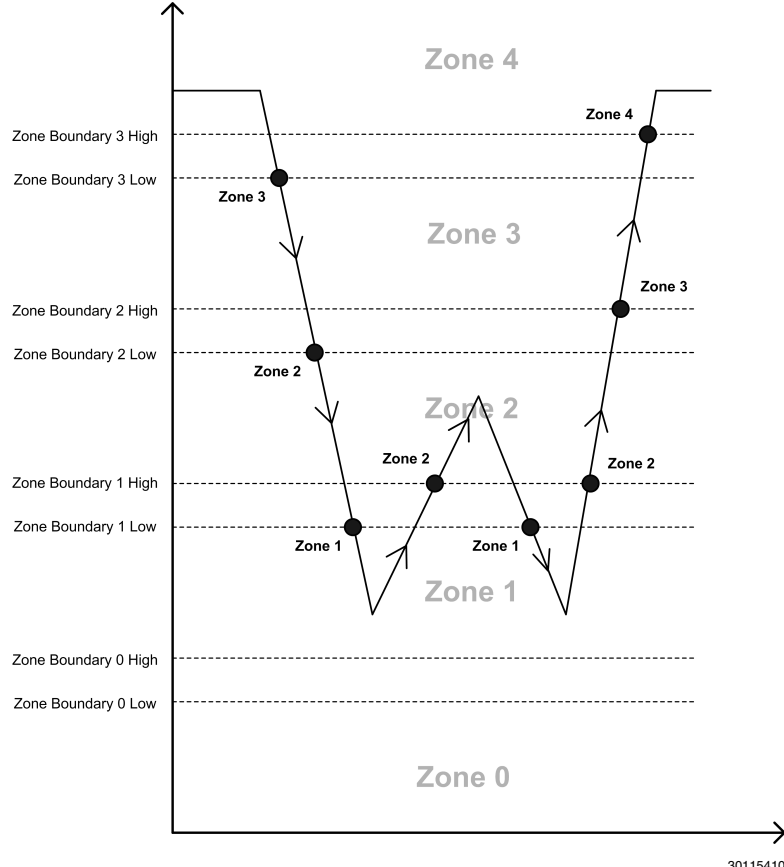

30115410

FIGURE 6. ALS Zone Boundaries + Hysteresis

PWM ENABLED FOR A PARTICULAR ZONE

The active PWM input for a specified Control Bank can be enabled/disabled for each ALS Brightness Zone. This is done via bits[6:2] of the corresponding Control A, B, or C PWM Registers (see *Table 6*, *Table 7*, and *Table 8*). For example, assuming Control Bank A is being used, then to make the PWM input active in Zones 0, 2, and 4, but not active in Zones

1, and 3, bits[6:2] of the Control A PWM Register would be set to (1, 0, 1, 0, 1).

ALS OPERATION

Figure 7 shows a functional block diagram of the LM3532's ambient light sensor interface.

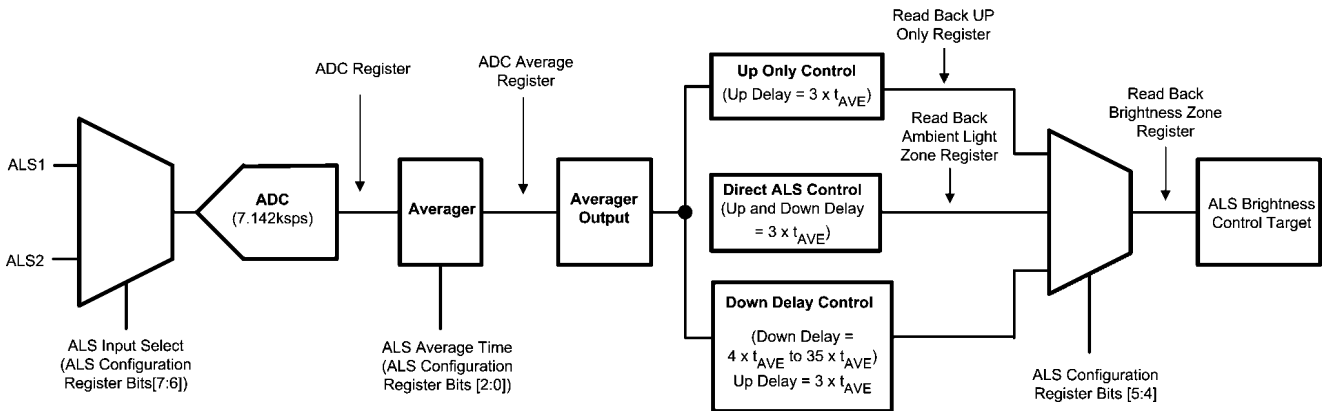

30115425

FIGURE 7. ALS Functional Block Diagram

ALS INPUT SELECT and ALS ADC INPUT

The internal 8-bit ADC digitizes the active ambient light sensor inputs (ALS1 or ALS2). The active ALS input is determined by the bit settings of the ALS input select bits, bits [7:6] in the ALS Configuration register. The active ALS input can be the average of ALS1 and ALS2, the maximum of ALS1 and ALS2, ALS1 only, or ALS2 only. Once the ALS input select stage selects the active ALS input, the result is sent to the internal 8-bit ADC. For example, if the active ALS input select is set to be the average of ALS1 and ALS2, then the voltage

at ALS1 and ALS2 is first averaged, then applied to the ADC. The output of the ADC (ADC Register) will be the digitized average value of ALS1 and ALS2.

The LM3532's internal ADC samples at 7.143 kbps. ADC timing is shown in *Figure 8*. When the ALS is Enabled (ALS Configuration Register bit [3] = 1) the ADC begins sampling and converting the active ALS input. Each conversion takes 140 μ s. After each conversion the ADC register is updated with new data.

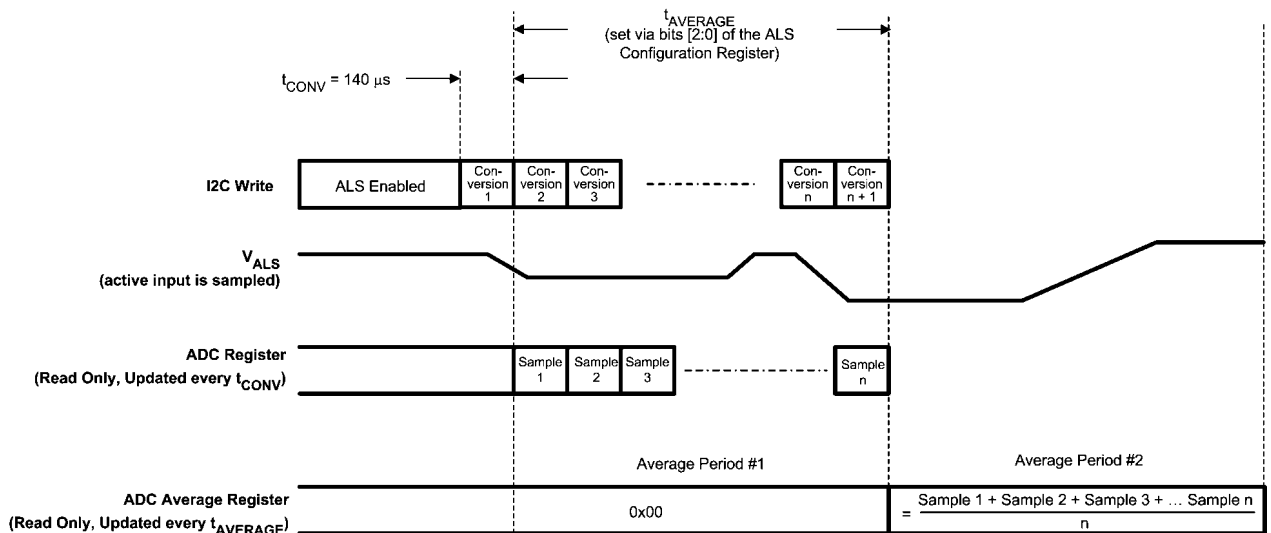

30115488

FIGURE 8. ADC Timing

ALS ADC READBACK

The digitized value of the LM3532's ADC is read back from the ADC Readback Register. Once the ALS is enabled the

ADC begins converting the active ALS input and updating the ALS Readback Register every 140 μ s. The ADC Readback register contains the updated data after each conversion.

ALS AVERAGING

ALS averaging is used to filter out any fast changes in the ambient light sensor inputs. This prevents the backlight current from constantly changing due to rapid fluctuations in the ambient light. There are 8 separate averaging periods available for the ALS inputs (see [Table 17](#)). During an average period the ADC continually samples at 7.143 ksp/s. Therefore, during an average period, the ALS Averager output will be the average of $7143/t_{AVE}$.

ALS ADC AVERAGE READBACK

The output of the LM3532's averager is read back via the Average ADC Register. This data is the ADC register data, averaged over the programmed ALS average time.

INITIALIZING THE ALS

On initial startup of the ALS Block, the Ambient Light Zone will default to Zone 0. This allows the ALS to start off in a predictable state. The drawback is that Zone 0 is often not representative of the true ALS Brightness Zone since the ALS inputs can get to their ambient light representative voltage much faster than the backlight is allowed to change. In order to avoid a multiple average time wait for the backlight current to get to its correct state, the LM3532 switches over to a fast average period (1.1 ms) on ALS startup. This will quickly bring the ALS Brightness Zone (and the backlight current) to its correct setting (see [Figure 9](#)).

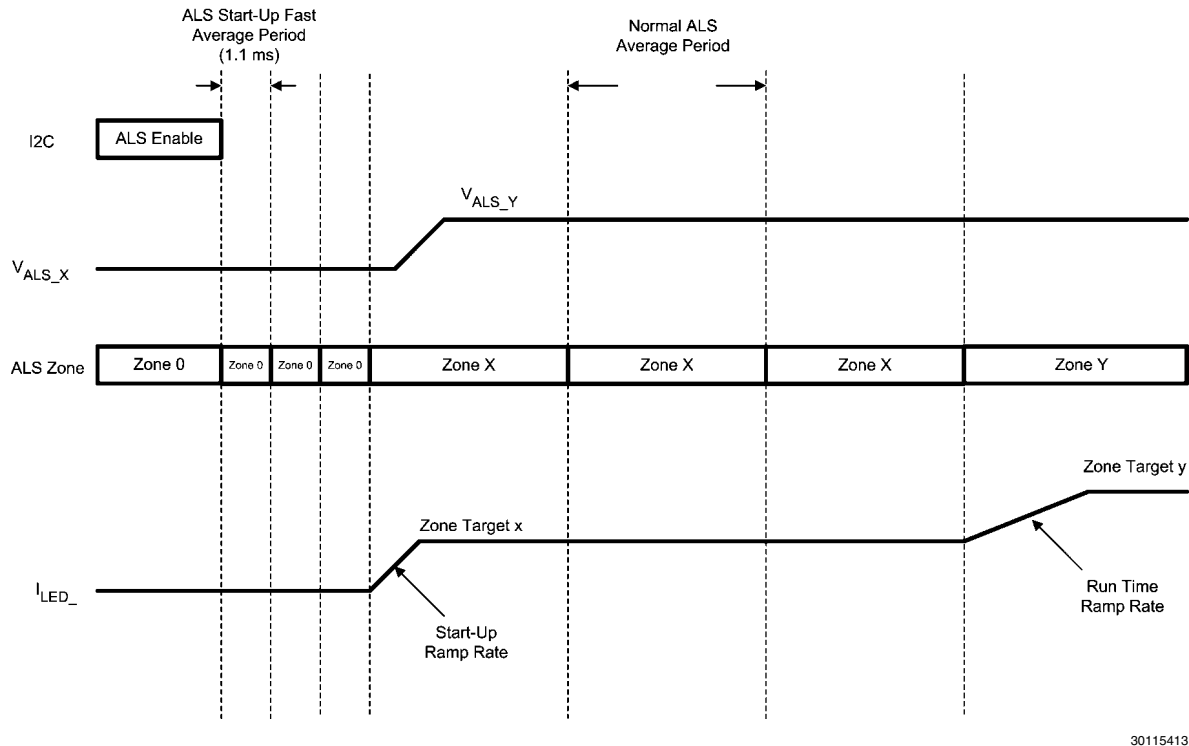

FIGURE 9. ALS Startup Sequence

ASL OPERATION

The LM3532's Ambient Light Sensor Interface has 3 different algorithms that can be used to control the ambient light to backlight current response.

ALS Algorithms

1. Direct ALS Control
2. Down Delay

For each algorithm, the ALS follows these basic rules:

ALS Rules

1. For the ALS Interface to force a change in the backlight current (to a higher zone target), the averager output must have shown an increase for 3 consecutive average periods, or an increase and a remain at the new zone for 3 consecutive average periods.
2. For the ALS Interface to force a change in the backlight current (to a lower zone target), the averager output must have shown a decrease for 3 consecutive average

periods, or a decrease and remain at the new zone for 3 consecutive average periods.

3. If condition #1 or #2 is satisfied, and during the next average period, the averager output changes again in the same direction as the last change, the LED current will immediately change at the beginning of the next average period.
4. If condition #1 or #2 is satisfied and the next average period shows no change in the average zone, or shows a change in the opposite direction, then the criteria in step #1 or #2 must be satisfied again before the ALS interface can force a change in the backlight current.
5. The Averager Output (see [Figure 7](#)) contains the zone that is determined from the most recent full average period.
6. The ALS Interface only forces a change in the backlight current at the beginning of an average period.
7. When the ALS forces a change in the backlight current the change will be to the brightness target pointed to by the zone in the Averager Output.

DIRECT ALS CONTROL

In direct ALS control the LM3532's ALS Interface can force the backlight current to either a higher zone target or a lower zone target using the rules described in the ALS Rules section.

In the example of *Figure 10* the plot shows the ALS voltage, the current average zone which is the zone determined by averaging the ALS voltage in the current average period, the Averager Output which is the zone determined from the previous full average period, and the target backlight current that is controlled by the ALS Interface. The following steps detail the Direct ALS algorithm:

1. When the ALS is enabled the ALS fast startup (1.1ms average period) quickly brings the Averager Output to the correct zone. This takes 3 fast average periods or approximately 3.3ms.
2. The 1st average period the ALS voltage averages to Zone 4.
3. The 2nd average period the ALS voltage averages to Zone 3.
4. The 3rd average period the ALS voltage averages to Zone 3 and the Averager Output shows a change from Zone 4 to Zone 3.
5. The 4th average period the ALS voltage averages to Zone 2 and the Averager Output remains at its changed state of Zone 3.
6. The 5th average period the ALS voltage averages to Zone 1. The Averager Output shows a change from Zone 3 to Zone 2. Since this is the 3rd average period that the Averager Output has shown a change in the decreasing direction from the initial Zone 4, the backlight current is forced to change to the current Averager Output (Zone 2's) target current.
7. The 6th average period the ALS voltage averages to Zone 2. The Averager Output changes from Zone 2 to Zone 1. Since this is in the same direction as the previous change, the backlight current is forced to change to the current Averager Output (Zone 1's) target current.
8. The 7th average period the ALS voltage averages to Zone 3. The Averager Output changes from Zone 1 to Zone 2. Since this change is in the opposite direction from the previous change, the backlight current remains at Zone 1's target.
9. The 8th average period the ALS voltage averages to Zone 3. The Averager Output changes from Zone 2 to Zone 3.
10. The 9th average period the ALS voltage averages to Zone 3. The Averager Output remains at Zone 3. Since this is the 3rd average period that the Averager Output has shown a change in the increasing direction from the initial Zone 1, the backlight current is forced to change to the current Averager Output (Zone 3's) target current.
11. The 10th average period the ALS voltage averages to Zone 4. The Averager Output remains at Zone 3.
12. The 11th average period the ALS voltage averages to Zone 4. The Averager Output changes to Zone 4.
13. The 12th average period the ALS voltage averages to Zone 4. The Averager Output remains at Zone 4.
14. The 13th average period the ALS voltage averages to Zone 4. The Averager Output remains at Zone 4. Since this is the 3rd average period that the Averager Output has shown a change in the increasing direction from the initial Zone 3, the backlight current is forced to change to the current Averager Output (Zone 4's) target current.

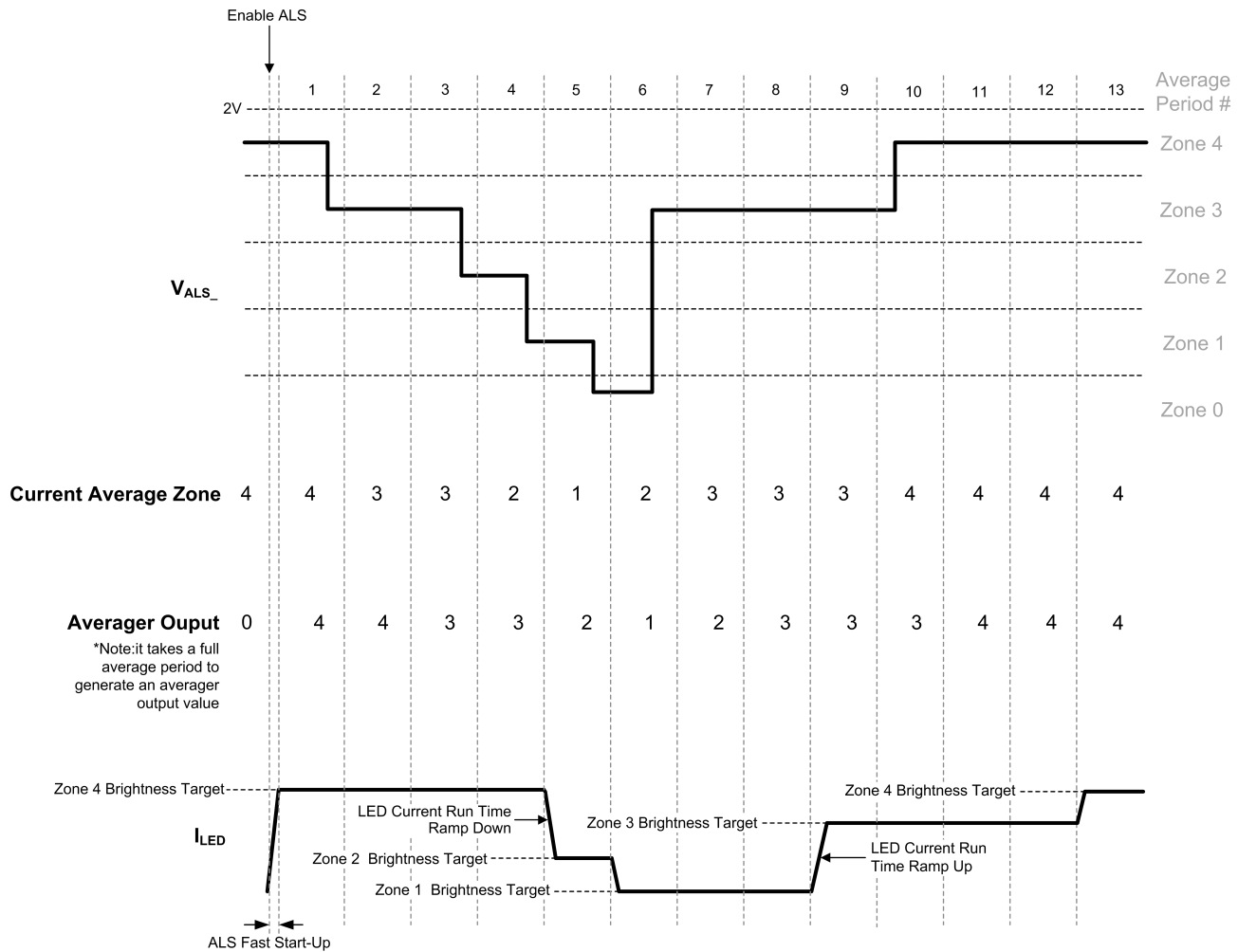

30115434

FIGURE 10. Direct ALS Control

DOWN DELAY

The Down-Delay algorithm uses all the same rules from the ALS Rules section, except it provides for adding additional average period delays required for decreasing transitions of the Averager Output, before the LED current is programmed to a lower zone target current. The additional average period delays are programmed via the ALS Down Delay register. The register provides 32 settings for increasing the down delay from 3 extra (code 00000) up to 34 extra (code 11111). For example, if the down delay algorithm is enabled, and the ALS Down Delay register were programmed with 0x00 (3 extra delays), then the Averager Output would need to see 6 consecutive changes in decreasing Zones (or 6 consecutive average periods that changed and remained lower), before the backlight current was programmed to the lower zones target current. Referring to [Figure 11](#), assume that Down Delay is enabled and the ALS Down Delay register is programmed with 0x02 (5 extra delays, 8 average period total delay for downward changes in the backlight target current):

1. When the ALS is enabled the ALS fast startup (1.1 ms average period) quickly brings the Averager Output to the correct zone. This takes 3 fast average periods or approximately 3.3 ms.
2. The first average period the ALS averages to Zone 3.

3. The second average period the ALS averages to Zone 2. The Averager Output remains at Zone 3.
4. The 3rd through 7th average period the ALS input averages to Zone 2, and the Averager Output stays at Zone 2.
5. The 8th average period the ALS input averages to Zone 4. The Averager Output remains at Zone 2.
6. The 9th and 10th average periods the ALS input averages to Zone 4. The Averager Output is at Zone 4. Since the Averager Output increased from Zone 2 to Zone 4 and the required Down Delay time was not met (8 average periods), the backlight current was never changed to the Zone 2's target current.
7. The 11th average period the ALS input averages to Zone 2. The Averager Output remains at Zone 4. Since this is the 3rd consecutive average period where the Averager Output has shown a change since the change from Zone 2, the backlight current transitions to Zone 4's target current.
8. The 12th through 26th average periods the ALS input averages to Zone 2. The Averager Output remains at Zone 2. At the start of average period #20 the Down Delay algorithm has shown the required 8 average period

delay from the initial change from Zone 4 to Zone 2. As a result the backlight current is programmed to Zone 2's target current.

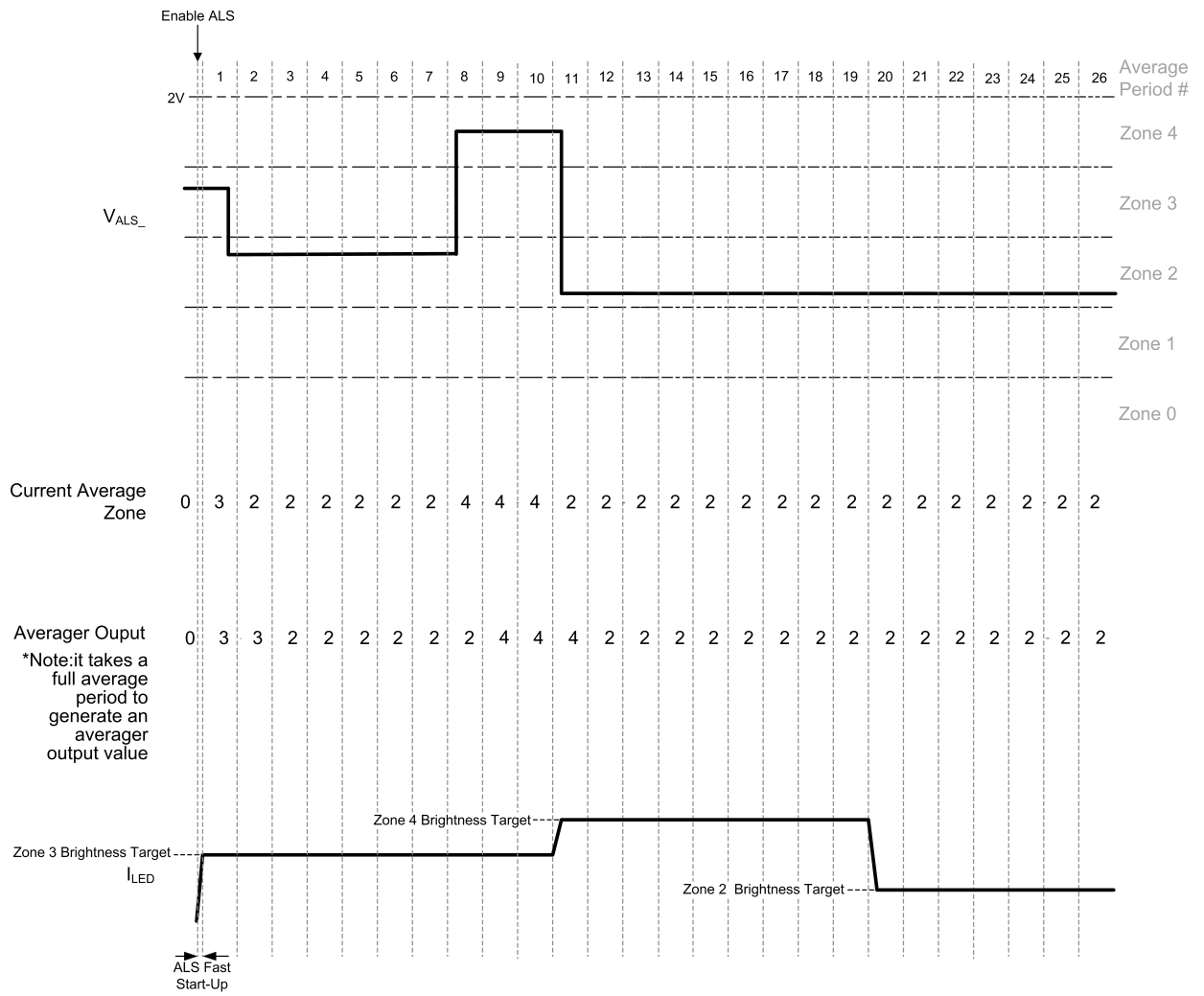

30115409

FIGURE 11. ALS Down-Delay Control

INTERRUPT OUTPUT

INT is an open drain output that pulls low when the ALS is enabled and when one of the ALS inputs transitions into a new zone. At the same time, the ALS Zone Information register is updated with the current ALS zone, and the software flag (bit 3 of the ALS Zone Information register) is written high. A readback of the Zone Information Register will clear the software interrupt flag and reset the INT output to the open drain state. The active pulldown at INT is typically 125Ω.

Protection Features

OVERVOLTAGE PROTECTION

The LM3532's boost converter provides open-load protection, by monitoring the OVP pin. The OVP pin is designed to connect as close as possible to the positive terminal of the output capacitor. In the event of a disconnected load (LED current string with feedback enabled), the output voltage will rise in order to try and maintain the correct headroom across the feedback enabled current sinks (see [Table 13](#)). Once VOUT climbs to the OVP threshold (V_{OVP}) the boost converter is turned off, and switching will stop until VOUT falls below the OVP hysteresis ($V_{OVP} - 1V$). Once the OVP hysteresis is crossed the LM3532's boost converter begins switching again. In open load conditions this would result in a pulsed on/off operation.

CURRENT LIMIT

The LM3532's peak current limit in the NFET is set at typically 1A (880 mA min.). During the positive portion of the switching cycle, if the NFET's current rises up to the current limit threshold, the NFET turns off for the rest of the switching cycle. At the start of the next switching cycle the NFET turns on again. For loads that cause the LM3532 to hit current limit each switching cycle, the output power can become clamped since the headroom across the feedback enabled current sinks is no longer being regulated when the device is in current limit. See [MAXIMUM OUTPUT POWER](#) below for guidelines on how peak current affects the LM3532's maximum output power.

MAXIMUM OUTPUT POWER

The LM3532's maximum output power is governed by two factors: the peak current limit ($I_{CL} = 880$ mA min.), and the maximum output voltage ($V_{OVP} = 40V$ min.). When the application causes either of these limits to be reached it is possible that the proper current regulation and matching between LED current strings will not be met.

Peak Current Limited

In the case of a peak current limited situation, when the peak of the inductor current hits the LM3532's current limit the NFET switch turns off for the remainder of the switching pe-

riod. If this happens, each switching cycle the LM3532 begins to regulate the peak of the inductor current instead of the headroom across the current sinks. This can result in the dropout of the feedback-enabled current sinks and the current dropping below its programmed level.

The peak current in a boost converter is dependent on the value of the inductor, total LED current (IOUT), the output voltage (VOUT) (which is the highest voltage LED string + 0.4V regulated headroom voltage), the input voltage VIN, and the efficiency (Output Power/Input Power). Additionally, the peak current is different depending on whether the inductor current is continuous during the entire switching period (CCM) or discontinuous (DCM) where it goes to 0 before the switching period ends.

For Continuous Conduction Mode the peak inductor current is given by:

$$I_{PEAK} = \frac{I_{OUT} \times V_{OUT}}{V_{IN} \times \text{efficiency}} + \left[\frac{V_{IN}}{2 \times f_{sw} \times L} \times \left(1 - \frac{V_{IN} \times \text{efficiency}}{V_{OUT}} \right) \right] \quad (1)$$

For Discontinuous Conduction Mode the peak inductor current is given by:

$$I_{PEAK} = \sqrt{\frac{2 \times I_{OUT}}{f_{sw} \times L \times \text{efficiency}} \times (V_{OUT} - V_{IN} \times \text{efficiency})} \quad (2)$$

To determine which mode the circuit is operating in (CCM or DCM) it is necessary to perform a calculation to test whether the inductor current ripple is less than the anticipated input current (IIN). If ΔI_L is < then IIN then the device will be operating in CCM. If ΔI_L is > IIN then the device is operating in DCM.

$$\frac{I_{OUT} \times V_{OUT}}{V_{IN} \times \text{efficiency}} > \frac{V_{IN}}{f_{sw} \times L} \times \left(1 - \frac{V_{IN} \times \text{efficiency}}{V_{OUT}} \right)$$

Typically at currents high enough to reach the LM3532's peak current limit, the device will be operating in CCM.

The following figures show the output current and voltage de-rating for a 10 μH and a 22 μH inductor. These plots take equations (1) and (2) from above and plot VOUT and IOUT with varying VIN, a constant peak current of 880 mA (ICL min), and a constant efficiency of 85%. Using these curves can give a good design guideline on selecting the correct inductor for a given output power requirement. A 10 μH will typically be a smaller device with lower on resistance, but the peak currents will be higher. A 22 μH provides for lower peak currents, but to match the DC resistance of a 10 μH requires a larger sized device.

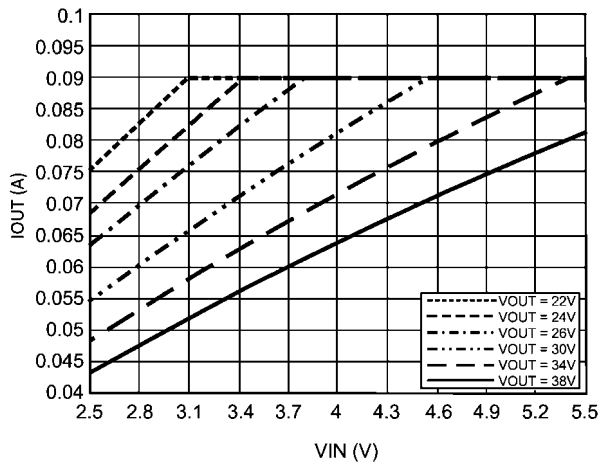

30115475

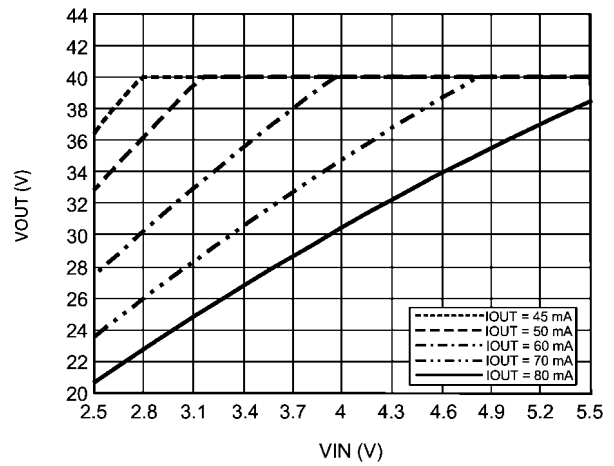

30115483

FIGURE 12. Maximum Output Power (22 μ H)

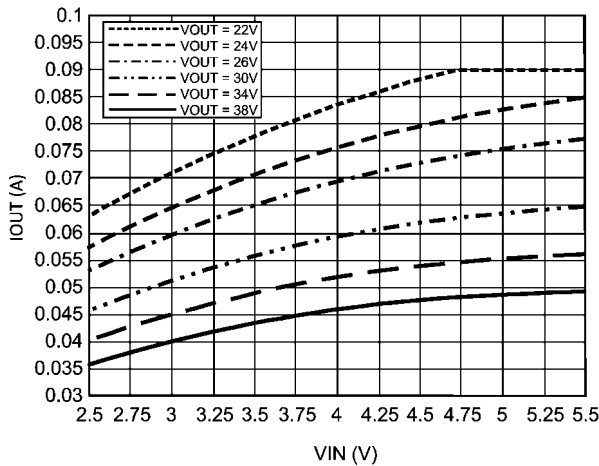

30115427

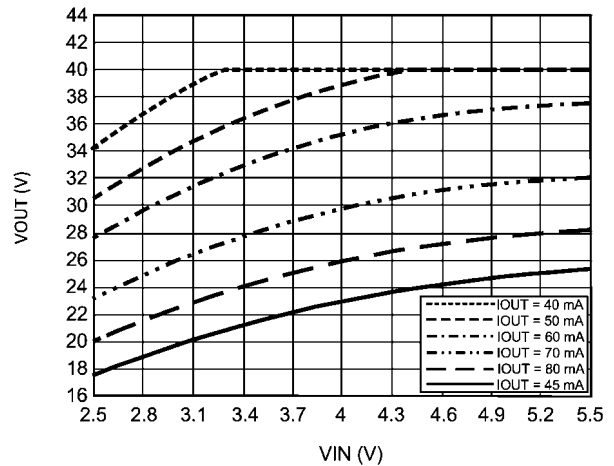

30115433

FIGURE 13. Maximum Output Power (10 μ H)

Output Voltage Limited

When the LM3532's output voltage (highest voltage LED string + 400 mV headroom voltage) reaches 40V, the OVP threshold is hit, and the NFET turns off and remains off until the output voltage drops 1V below the OVP threshold. Once VOUT falls below this hysteresis, the boost converter will turn

on again. In high output voltage situations the LM3532 will begin to regulate the output voltage to the VOVP level instead of the current sink headroom voltage. This can result in a loss of headroom voltage across the feedback enabled current sinks resulting in the LED current dropping below its programmed level.

I²C-Compatible Interface

START AND STOP CONDITION

The LM3532 is controlled via an I²C-compatible interface. START and STOP conditions classify the beginning and the end of the I²C session. A START condition is defined as SDA transitioning from HIGH-to-LOW while SCL is HIGH. A STOP condition is defined as SDA transitioning from LOW-to-HIGH while SCL is HIGH. The I²C master always generates the

START and STOP conditions. The I²C bus is considered busy after a START condition and free after a STOP condition. During data transmission, the I²C master can generate repeated START conditions. A START and a repeated START conditions are equivalent function-wise. The data on SDA must be stable during the HIGH period of the clock signal (SCL). In other words, the state of SDA can only be changed when SCL is LOW.

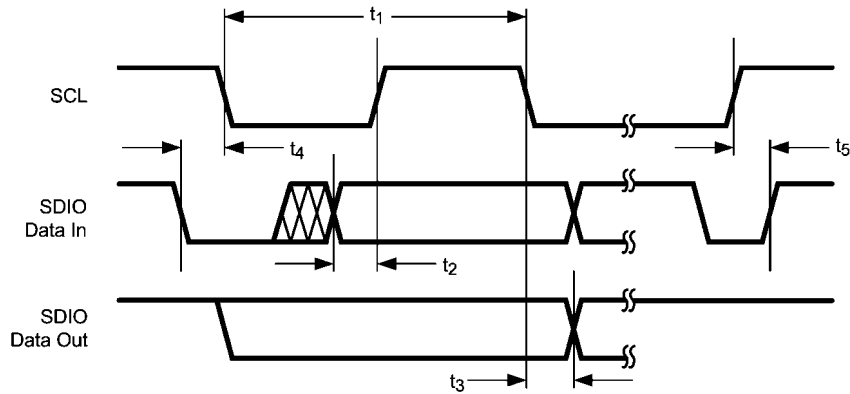

30115403

FIGURE 14. Start and Stop Sequences

I²C-Compatible Address

The 7-bit chip address for the LM3532 is (0x38). After the START condition, the I²C master sends the 7-bit chip address followed by an eighth bit (LSB) read or write (R/W). R/W = 0

indicates a WRITE and R/W = 1 indicates a READ. The second byte following the chip address selects the register address to which the data will be written. The third byte contains the data for the selected register.

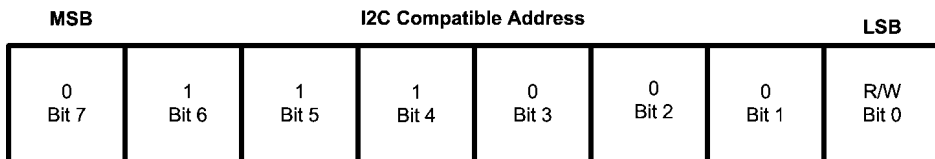

30115438

FIGURE 15. I²C-Compatible Chip Address (0x38)

Transferring Data

Every byte on the SDA line must be eight bits long, with the most significant bit (MSB) transferred first. Each byte of data must be followed by an acknowledge bit (ACK). The acknowledge related clock pulse (9th clock pulse) is generated by the

master. The master then releases SDA (HIGH) during the 9th clock pulse. The LM3532 pulls down SDA during the 9th clock pulse, signifying an acknowledge. An acknowledge is generated after each byte has been received.

LM3532 Register Descriptions

TABLE 2. LM3532 Register Descriptions

Name	Address	Power On Reset
I ² C Address	0x38 (7 bit), 0x70 for Write and 0x71 for Read	
Output Configuration	0x10	0xE4
Startup/Shutdown Ramp Rate	0x11	0xC0
Run Time Ramp Rate	0x12	0xC0
Control A PWM	0x13	0x82
Control B PWM	0x14	0x82
Control C PWM	0x15	0x82
Control A Brightness	0x16	0xF1
Control A Full-Scale Current	0x17	0xF3
Control B Brightness	0x18	0xF1
Control B Full-Scale Current	0x19	0xF3
Control C Brightness	0x1A	0xF1
Control C Full-Scale Current	0x1B	0xF3
Feedback Enable	0x1C	0xFF
Control Enable	0x1D	0xF8
ALS1 Resistor Select	0x20	0xE0
ALS2 Resistor Select	0x21	0xE0
ALS Down Delay	0x22	0xE0
ALS Configuration	0x23	0x44
ALS Zone Information	0x24	0xF0
ALS Brightness Zone	0x25	0xF8
ADC	0x27	0x00
ADC Average	0x28	0x00
ALS Zone Boundary 0 High	0x60	0x35
ALS Zone Boundary 0 Low	0x61	0x33
ALS Zone Boundary 1 High	0x62	0x6A
ALS Zone Boundary 1 Low	0x63	0x66
ALS Zone Boundary 2 High	0x64	0xA1
ALS Zone Boundary 2 Low	0x65	0x99
ALS Zone Boundary 3 High	0x66	0xDC
ALS Zone Boundary 3 Low	0x67	0xCC
Control A Zone Target 0	0x70	0x33
Control A Zone Target 1	0x71	0x66
Control A Zone Target 2	0x72	0x99
Control A Zone Target 3	0x73	0xCC
Control A Zone Target 4	0x74	0xFF
Control B Zone Target 0	0x75	0x33
Control B Zone Target 1	0x76	0x66
Control B Zone Target 2	0x77	0x99
Control B Zone Target 3	0x78	0xCC
Control B Zone Target 4	0x79	0xFF
Control C Zone Target 0	0x7A	0x33
Control C Zone Target 1	0x7B	0x66
Control C Zone Target 2	0x7C	0x99
Control C Zone Target 3	0x7D	0xCC
Control C Zone Target 4	0x7E	0xFF

OUTPUT CONFIGURATION

This register configures how the three control banks are routed to the current sinks (ILED1, ILED2, ILED3)

TABLE 3. Output Configuration Register Description (Address 0x10)

Bit [7:6]	Bits [5:4] ILED3 Control	Bits [3:2] ILED2 Control	Bits [1:0] ILED1 Control
Not Used	00 = ILED3 is controlled by Control A PWM and Control A Brightness Registers (default) 01 = ILED3 is controlled by Control B PWM and Control B Brightness Registers 1X = ILED3 is controlled by Control C PWM and Control C Brightness Registers	00 = ILED2 is controlled by Control A PWM and Control A Brightness Registers (default) 01 = ILED2 is controlled by Control B PWM and Control B Brightness Registers 1X = ILED2 is controlled by Control C PWM and Control C Brightness Registers	00 = ILED1 is controlled by Control A PWM and Control A Brightness Registers (default) 01 = ILED1 is controlled by Control B PWM and Control B Brightness Registers 1X = ILED1 is controlled by Control C PWM and Control C Brightness Registers

STARTUP/SHUTDOWN RAMP RATE

This register controls the ramping of the LED current in current sinks ILED1, ILED2, and ILED3 during startup and shutdown. The startup ramp rates/step are from when the device is enabled via I²C to when the target current is reached. The

Shutdown ramp rates/step are from when the device is shut down via I²C until the LED current is 0. To start up and shut down the current sinks via I²C, see the Control Enable Register.

TABLE 4. Startup/Shutdown Ramp Rate Register Description (Address 0x11)

Bits [7:6]	Bits [5:3] Shutdown Ramp	Bits [2:0] Startup Ramp
Not Used	000 = 8 μ s/step (2.048ms from Full-Scale to 0) (default) 001 = 1.024 ms/step (261 ms) 010 = 2.048 ms/step (522 ms) 011 = 4.096 ms/step (1.044s) 100 = 8.192 ms/step (2.088s) 101 = 16.384 ms/step (4.178s) 110 = 32.768 ms/step (8.356s) 111 = 65.536 ms/step (16.711s)	000 = 8 μ s/step (2.048ms from Full-Scale to 0) (default) 001 = 1.024 ms/step (261ms) 010 = 2.048 ms/step (522ms) 011 = 4.096 ms/step (1.044s) 100 = 8.192 ms/step (2.088s) 101 = 16.384 ms/step (4.178s) 110 = 32.768 ms/step (8.356s) 111 = 65.536 ms/step (16.711s)

RUN TIME RAMP RATE

This register controls the ramping of the current in current sinks ILED1, ILED2, and ILED3. The Run Time ramp rates/

step are from one current set-point to another after the device has reached its initial target set point from turn-on.

TABLE 5. Run Time Ramp Rate Register Description (Address 0x12)

Bits [7:6]	Bits [5:3] Ramp Down	Bits [2:0] Ramp Up
Not Used	000 = 8 μ s/step (default) 001 = 1.024 ms/step 010 = 2.048 ms/step 011 = 4.096 ms/step 100 = 8.192 ms/step 101 = 16.384 ms/step 110 = 32.768 ms/step 111 = 65.536 ms/step	000 = 8 μ s/step (default) 001 = 1.024 ms/step 010 = 2.048 ms/step 011 = 4.096 ms/step 100 = 8.192 ms/step 101 = 16.384 ms/step 110 = 32.768 ms/step 111 = 65.536 ms/step

CONTROL A PWM

This register configures which PWM input (PWM1 or PWM2) is mapped to Control Bank A and which zones the selected PWM input is active in.

TABLE 6. Control A PWM Register Description (Address 0x13)

Bit 7 N/A	Bit 6 Zone 4 PWM Enable	Bit 5 Zone 3 PWM Enable	Bit 2 Zone 2 PWM Enable	Bit 2 Zone 1 PWM Enable	Bit 2 Zone 0 PWM Enable	Bit 1 PWM Input Polarity	Bit 0 PWM Select
Not Used	0 = Active PWM input is disabled in Zone 4 (default) 1 = Active PWM input is enabled in Zone 4	0 = Active PWM input is disabled in Zone 3 (default) 1 = Active PWM input is enabled in Zone 3	0 = Active PWM input is disabled in Zone 2 (default) 1 = Active PWM input is enabled in Zone 2	0 = Active PWM input is disabled in Zone 1 (default) 1 = Active PWM input is enabled in Zone 1	0 = Active PWM input is disabled in Zone 0 (default) 1 = Active PWM input is enabled in Zone 0	0 = active low polarity 1 = active high polarity (default)	0 = PWM1 input is mapped to Control Bank A (default) 1 = PWM2 is mapped to Control Bank A

CONTROL B PWM

This register configures which PWM input (PWM1 or PWM2) is mapped to Control Bank B and which zones the selected PWM input is active in.

TABLE 7. Control B PWM Register Description (Address 0x14)

Bit 7 N/A	Bit 6 Zone 4 PWM Enable	Bit 5 Zone 3 PWM Enable	Bit 2 Zone 2 PWM Enable	Bit 2 Zone 1 PWM Enable	Bit 2 Zone 0 PWM Enable	Bit 1 PWM Input Polarity	Bit 0 PWM Select
Not Used	0 = Active PWM input is disabled in Zone 4 (default) 1 = Active PWM input is enabled in Zone 4	0 = Active PWM input is disabled in Zone 3 (default) 1 = Active PWM input is enabled in Zone 3	0 = Active PWM input is disabled in Zone 2 (default) 1 = Active PWM input is enabled in Zone 2	0 = Active PWM input is disabled in Zone 1 (default) 1 = Active PWM input is enabled in Zone 1	0 = Active PWM input is disabled in Zone 0 (default) 1 = Active PWM input is enabled in Zone 0	0 = active low polarity 1 = active high polarity (default)	0 = PWM1 input is mapped to Control Bank B (default) 1 = PWM2 is mapped to Control Bank B

CONTROL C PWM

This register configures which PWM input (PWM1 or PWM2) is mapped to Control Bank C and which zones the selected PWM input is active in.

TABLE 8. Control C PWM Register Description (Address 0x15)

Bit 7 N/A	Bit 6 Zone 4 PWM Enable	Bit 5 Zone 3 PWM Enable	Bit 2 Zone 2 PWM Enable	Bit 2 Zone 1 PWM Enable	Bit 2 Zone 0 PWM Enable	Bit 1 PWM Input Polarity	Bit 0 PWM Select
Not Used	0 = Active PWM input is disabled in Zone 4 (default) 1 = Active PWM input is enabled in Zone 4	0 = Active PWM input is disabled in Zone 3 (default) 1 = Active PWM input is enabled in Zone 3	0 = Active PWM input is disabled in Zone 2 (default) 1 = Active PWM input is enabled in Zone 2	0 = Active PWM input is disabled in Zone 1 (default) 1 = Active PWM input is enabled in Zone 1	0 = Active PWM input is disabled in Zone 0 (default) 1 = Active PWM input is enabled in Zone 0	0 = active low polarity 1 = active high polarity (default)	0 = PWM1 input is mapped to Control Bank C (default) 1 = PWM2 is mapped to Control Bank C

CONTROL A BRIGHTNESS CONFIGURATION

The Control A Brightness Configuration Register has 3 functions:

1. Selects how the LED current sink which is mapped to Control Bank A is controlled (either directly through the I²C or via the ALS interface)
2. Programs the LED current mapping mode for Control Bank A (Linear or Exponential)
3. Programs which Control A Zone Target Register is the Brightness Register for Bank A in I²C Current Control

TABLE 9. Control A Brightness Configuration Register Description (Address 0x16)

Bits [7:5] Not Used	Bits [4:2] Control A Brightness Pointer (I ² C Current Control Only)	Bit 1 LED Current Mapping Mode	Bit 0 Bank A Current Control
N/A	000 = Control A Zone Target 0 001 = Control A Zone Target 1 010 = Control A Zone Target 2 011 = Control A Zone Target 3 1XX = Control A Zone Target 4 (default)	0 = Exponential Mapping (default) 1 = Linear Mapping	0 = ALS Current Control 1 = I ² C Current Control (default)

CONTROL B BRIGHTNESS CONFIGURATION

The Control B Brightness Configuration Register has 3 functions:

1. Selects how the LED current sink which is mapped to Control Bank B is controlled (either directly through the I²C or via the ALS interface)
2. Programs the LED current mapping mode for Control Bank B (Linear or Exponential)
3. Programs which Control B Zone Target Register is the Brightness Register for Bank B in I²C Current Control

TABLE 10. Control B Brightness Configuration Register Description (Address 0x18)

Bits [7:5] Not Used	Bits [4:2] Control A Brightness Pointer (I ² C Current Control Only)	Bit 1 LED Current Mapping Mode	Bit 0 Bank B Current Control
N/A	000 = Control B Zone Target 0 001 = Control B Zone Target 1 010 = Control B Zone Target 2 011 = Control B Zone Target 3 1XX = Control B Zone Target 4 (default)	0 = Exponential Mapping (default) 1 = Linear Mapping	0 = ALS Current Control 1 = I ² C Current Control (default)

CONTROL C BRIGHTNESS CONFIGURATION

The Control C Brightness Configuration Register has 3 functions:

1. Selects how the LED current sink which is mapped to Control Bank C is controlled (either directly through the I²C or via the ALS interface)
2. Programs the LED current mapping mode for Control Bank C (Linear or Exponential)
3. Programs which Control C Zone Target Register is the Brightness Register for Bank C in I²C Current Control

TABLE 11. Control C Brightness Configuration Register Description (Address 0x1A)

Bits [7:5] Not Used	Bits [4:2] Control C Brightness Pointer (I ² C Current Control Only)	Bit 1 LED Current Mapping Mode	Bit 0 Bank C Current Control
N/A	000 = Control C Zone Target 0 001 = Control C Zone Target 1 010 = Control C Zone Target 2 011 = Control C Zone Target 3 1XX = Control C Zone Target 4 (default)	0 = Exponential Mapping (default) 1 = Linear Mapping	0 = ALS Current Control 1 = I ² C Current Control (default)

CONTROL A/B/C FULL-SCALE CURRENT

These registers program the full-scale current setting for the current sink(s) assigned to Control Bank A/B/C. Each Control

Bank has its own full-scale current setting (Control Bank A, Address 0x17), (Control Bank B, address 0x19), (Control Bank C, address 0x1B).

TABLE 12. Control A/B/C Full-Scale Current Registers Descriptions (Address 0x17, 0x19, 0x1B)

Bits [7:5] Not Used	Bits [4:0] Control A/B/C Full-Scale Current Select Bits
N/A	00000 = 5 mA
N/A	00001 = 5.8 mA
N/A	00010 = 6.6 mA
N/A	00011 = 7.4 mA
N/A	00100 = 8.2 mA
N/A	00101 = 9 mA
N/A	00110 = 9.8 mA
N/A	00111 = 10.6 mA
N/A	01000 = 11.4 mA
N/A	01001 = 12.2 mA
N/A	01010 = 13 mA
N/A	01011 = 13.8 mA
N/A	01100 = 14.6 mA
N/A	01101 = 15.4 mA
N/A	01110 = 16.2 mA
N/A	01111 = 17 mA
N/A	10000 = 17.8 mA
N/A	10001 = 18.6mA
N/A	10010 = 19.4 mA
N/A	10011 = 20.2 mA (default)
N/A	10100 = 21 mA
N/A	10101 = 21.8 mA
N/A	10110 = 22.6 mA
N/A	10111 = 23.4 ma
N/A	11000 = 24.2 mA
N/A	11001 = 25 mA
N/A	11010 = 25.8 mA
N/A	11011 = 26.6 mA
N/A	11100 = 27.4 mA
N/A	11101 = 28.2 mA
N/A	11110 = 29 mA
N/A	11111 = 29.8 mA

FEEDBACK ENABLE

The Feedback Enable Register configures which current sinks are or are not part of the boost control loop.

TABLE 13. Feedback Enable Register Description (Address 0x1C)

Bits [7:3] Not Used	Bit 2 ILED3 Feedback Enable	Bit 1 ILED2 Feedback Enable	Bit 0 ILED1 Feedback Enable
N/A	0 = ILED3 is not part of the boost control loop 1 = ILED3 is part of the boost control loop (default)	0 = ILED2 is not part of the boost control loop 1 = ILED2 is part of the boost control loop (default)	0 = ILED1 is not part of the boost control loop 1 = ILED1 is part of the boost control loop (default)

CONTROL ENABLE

The Control Enable register contains the bits to turn on/off the individual Control Banks (A, B, or C). Once one of these bits

is programmed high, the current sink(s) assigned to the selected control banks are enabled.

TABLE 14. Control Enable Register Description (Address 0x1D)

Bits (7:3) (Not Used)	Bit 2 Control C Enable	Bit 1 Control B Enable	Bit 0 Control A Enable
N/A	0 = Control C is disabled (default) 1 = Control C is enabled	0 = Control B is disabled (default) 1 = Control B is enabled	0 = Control A is disabled (default) 1 = Control A is enabled

ALS1 & 2 RESISTOR SELECT

The ALS Resistor Select Registers program the internal pull-down resistor at the ALS1/ALS2 input. Each ALS input has its own resistor select register (ALS1 Resistor Select Register, Address 0x20) and (ALS2 Resistor Select Register, Address

0x21). Each ALS input can be set independent of the other. There are 32 available resistors including a high impedance setting. The full-scale input voltage range at either ALS input is 2V.

TABLE 15. ALS Resistor Select Register Description (Address 0x20, Address 0x21)

Bit [7:5] Not Used	Bit [4:0] ALS1/ALS2 Resistor Select Bits
N/A	00000 = High Impedance (default)
	00001 = 37 k Ω
	00010 = 18.5 k Ω
	00011 = 12.33 k Ω
	00100 = 9.25 k Ω
	00101 = 7.4 k Ω
	00110 = 6.17 k Ω
	00111 = 5.29 k Ω
	01000 = 4.63 k Ω
	01001 = 4.11 k Ω
	01010 = 3.7 k Ω
	01011 = 3.36 k Ω
	01100 = 3.08 k Ω
	01101 = 2.85 k Ω
	01110 = 2.64 k Ω
	01111 = 2.44 k Ω
	10000 = 2.31 k Ω
	10001 = 2.18 k Ω
	10010 = 2.06 k Ω
	10011 = 1.95 k Ω
	10100 = 1.85 k Ω
	10101 = 1.76 k Ω
	10110 = 1.68 k Ω
	10111 = 1.61 k Ω
	11000 = 1.54 k Ω
	11001 = 1.48 k Ω
	11010 = 1.42 k Ω
	11011 = 1.37 k Ω
	11100 = 1.32 k Ω
	11101 = 1.28 k Ω
	11110 = 1.23 k Ω
	11111 = 1.19 k Ω

ALS DOWN DELAY

The ALS Down Delay Register adds additional average time delays for ALS changes in the backlight current during falling

ALS input voltages. Code 00000 adds 3 extra average period delays on top of the 3 default delays (6 total). Code 11111 adds 34 extra average period delays.

TABLE 16. ALS Down Delay Register Description (Address 0x22)

Bits [7:6] Not Used	Bit [5] ALS Fast startup Enable	Bits [4:0] Down Delay
N/A	0 = ALS Fast startup is Disabled 1 = ALS Fast startup is Enabled (default)	00000 = 6 total Average Period delay for Down Delay Control (default) : : : 11111 = 34 total Average Periods of Delay for Down Delay Control

ALS CONFIGURATION

The ALS Configuration register controls the ALS average times, the ALS enable bit, and the ALS input select.

TABLE 17. ALS Configuration Register Description (Address 0x23)

Bits [7:6] ALS Input Select	Bit [5:4] ALS Control	Bit 3 ALS Enable	Bits [2:0] ALS Average Time
00 = Average of ALS1 and ALS2 is used to determine backlight current 01 = Only the ALS1 input is used to determine backlight current (default) 10 = Only the ALS2 input is used to determine the backlight current 11 = The maximum of ALS1 and ALS2 is used to determine the backlight current	00 = Direct ALS Control. ALS inputs respond to up and down transitions (default) 01 = This setting is for a future mode. 1X = Down Delay Control. Extra delays of $3 \times t_{AVE}$ to $34 \times t_{AVE}$ are added for down transitions, before the new backlight target is programmed. (see DOWN DELAY section).	0 = ALS is disabled (default) 1 = ALS is enabled	000 = 17.92 ms 001 = 35.84 ms 010 = 71.68 ms 011 = 143.36 ms 100 = 286.72 ms (default) 101 = 573.44 ms 110 = 1146.88 ms 111 = 2293.76 ms

ALS ZONE READBACK / INFORMATION

The ALS Zone Readback and ALS Zone Information Readback registers each contain information on the current ambient light brightness zone. The ALS Zone Readback register contains the ALS Zone after the averager and discriminator block and reflects both up and down changes in the ambient

light brightness zone. The ALS Zone Information register reflects the contents of either the ALS Zone Readback register (with up and down transition). This register also includes a Zone Change bit (bit 3) which is written with a 1 each time the ALS zone changes. This bit is cleared upon read back of the ALS Zone Information register.

TABLE 18. ALS Zone Information Register Description (Address 0x24)

Bits [7:4] Not Used	Bit 3 Zone Change Bit	Bits [2:0] Brightness Zone
N/A	0 = No change in ALS Zone (default) 1 = There was a change in the ALS Zone since the last read of this register. This bit is cleared on read back.	000 = Zone 0 (default) 001 = Zone 1 010 = Zone 2 011 = Zone 3 1XX = Zone 4

TABLE 19. ALS Zone Readback Register Description (Address 0x25)

Bits [7:3] Not Used	Bits [2:0] Brightness Zone
N/A	000 = Zone 0 (default) 001 = Zone 1 010 = Zone 2 011 = Zone 3 1XX = Zone 4

ALS ZONE BOUNDARIES

There are 4 ALS Zone Boundary registers which form the boundaries for the 5 Ambient Light Zones. Each Zone Boundary register is 8 bits with a maximum voltage of 2V. This gives a step size for each Zone Boundary Register bit of:

$$\text{ZoneBoundaryLSB} = \frac{2V}{255} = 7.8 \text{ mV}$$

ALS Zone Boundary 0 High (Address 0x60), **default = 0x35 (415.7 mV)**
ALS Zone Boundary 0 Low (Address 0x61), **default = 0x33 (400 mV)**

ALS Zone Boundary 1 High (Address 0x62), **default = 0x6A (831.4 mV)**
ALS Zone Boundary 1 Low (Address 0x63), **default = 0x66 (800 mV)**

ALS Zone Boundary 2 High (Address 0x64), **default = 0xA1 (1262.7 mV)**
ALS Zone Boundary 2 Low (Address 0x65), **default = 0x99 (1200 mV)**

ALS Zone Boundary 3 High (Address 0x66), **default = 0xDC (1725.5 mV)**
ALS Zone Boundary 3 Low (Address 0x67), **default = 0xCC (1600 mV)**

(See ALS Zone Boundaries + Hysteresis [Figure 6](#))

ZONE TARGET REGISTERS

There are 3 groups of Zone Target Registers (Control A, Control B, and Control C). The Zone Target registers have 2 functions. In Ambient Light Current control, they map directly

to the corresponding ALS Zone. When the active ALS input lands within the programmed Zone, the backlight current is programmed to the corresponding zone target registers set point (see below).

Control A Zone Target Register 0 maps directly to Zone 0 (Address 0x70)
Control A Zone Target Register 1 maps directly to Zone 1 (Address 0x71)
Control A Zone Target Register 2 maps directly to Zone 2 (Address 0x72)
Control A Zone Target Register 3 maps directly to Zone 3 (Address 0x73)
Control A Zone Target Register 4 maps directly to Zone 4 (Address 0x74)

Control B Zone Target Register 0 maps directly to Zone 0 (Address 0x75)
Control B Zone Target Register 1 maps directly to Zone 1 (Address 0x76)
Control B Zone Target Register 2 maps directly to Zone 2 (Address 0x77)
Control B Zone Target Register 3 maps directly to Zone 3 (Address 0x78)
Control B Zone Target Register 4 maps directly to Zone 4 (Address 0x79)

Control C Zone Target Register 0 maps directly to Zone 0 (Address 0x7A)
Control C Zone Target Register 1 maps directly to Zone 1 (Address 0x7B)
Control C Zone Target Register 2 maps directly to Zone 2 (Address 0x7C)
Control C Zone Target Register 3 maps directly to Zone 3 (Address 0x7D)
Control C Zone Target Register 4 maps directly to Zone 4 (Address 0x7E)

(See Ambient Light Input to Backlight Mapping, [Figure 5](#))

In I²C Current Control, any of the 5 Zone Target Registers for the particular Control Bank can be the LED brightness regis-

ters. This is set according to Control A, B, or C Brightness Configuration Registers (Bits [4:2]).

Applications Information

INDUCTOR SELECTION

The LM3532 is designed to work with a 10 μH to 22 μH inductor. When selecting the inductor, ensure that the saturation rating is high enough to accommodate the applications peak inductor current. The inductance value must also be large enough so that the peak inductor current is kept below

the LM3532's switch current limit. See the [MAXIMUM OUTPUT POWER](#) Section for more details. [Table 20](#) lists various inductors that can be used with the LM3532. The inductors with higher saturation currents are more suitable for applications with higher output currents or voltages (multiple strings). The smaller devices are geared toward single string applications with lower series LED counts.

TABLE 20. Inductors

Manufacturer	Part Number	Value	Size	Current Rating	DC Resistance
TDK	VLS252010T-100M	10 μH	2.5 mm \times 2 mm \times 1 mm	590 mA	0.712 Ω
TDK	VLS2012ET-100M	10 μH	2 mm \times 2 mm \times 1.2 mm	695 mA	0.47 Ω
TDK	VLF301512MT-100M	10 μH	3.0 mm \times 2.5 mm \times 1.2mm	690 mA	0.25 Ω
TDK	VLF4010ST-100MR80	10 μH	2.8 mm \times 3 mm \times 1 mm	800 mA	0.25 Ω
TDK	VLS252012T-100M	10 μH	2.5 mm \times 2 mm \times 1.2mm	810 mA	0.63 Ω
TDK	VLF3014ST-100MR82	10 μH	2.8 mm \times 3 mm \times 1.4mm	820 mA	0.25 Ω
TDK	VLF4014ST-100M1R0	10 μH	3.8 mm \times 3.6 mm \times 1.4 mm	1000 mA	0.22 Ω
Coilcraft	XPL2010-103ML	10 μH	1.9 mm \times 2 mm \times 1 mm	610 mA	0.56 Ω
Coilcraft	LPS3010-103ML	10 μH	2.95 mm \times 2.95 mm \times 0.9 mm	550 mA	0.54 Ω
Coilcraft	LPS4012-103ML	10 μH	3.9mm \times 3.9mm \times 1.1mm	1000 mA	0.35 Ω
Coilcraft	LPS4012-223ML	22 μH	3.9 mm \times 3.9 mm \times 1.1 mm	780 mA	0.6 Ω
Coilcraft	LPS4018-103ML	10 μH	3.9 mm \times 3.9 mm \times 1.7 mm	1100 mA	0.2 Ω
Coilcraft	LPS4018-223ML	22 μH	3.9 mm \times 3.9 mm \times 1.7 mm	700 mA	0.36 Ω

CAPACITOR SELECTION

The LM3532's output capacitor has two functions: filtering of the boost converter's switching ripple, and to ensure feedback loop stability. As a filter, the output capacitor supplies the LED current during the boost converter's on time and absorbs the inductor's energy during the switch's off time. This causes a sag in the output voltage during the on time and a rise in the output voltage during the off time. Because of this, the output

capacitor must be sized large enough to filter the inductor current ripple that could cause the output voltage ripple to become excessive. As a feedback loop component, the output capacitor must be at least 1 μF and have low ESR; otherwise, the LM3532's boost converter can become unstable. This requires the use of ceramic output capacitors. [Table 21](#) lists part numbers and voltage ratings for different output capacitors that can be used with the LM3532.

TABLE 21. Input/Output Capacitors

Manufacturer	Part Number	Value	Size	Rating	Description
Murata	GRM21BR71H105KA12	1 μF	0805	50V	COUT
Murata	GRM188B31A225KE33	2.2 μF	0805	10V	CIN
TDK	C1608X5R0J225	2.2 μF	0603	6.3V	CIN

DIODE SELECTION

The diode connected between SW and OUT must be a Schottky diode and have a reverse breakdown voltage high enough to handle the maximum output voltage in the application. [Table 22](#) lists various diodes that can be used with the LM3532.

TABLE 22. Diodes

Manufacturer	Part Number	Value	Size	Rating
Diodes Inc.	B0540WS	Schottky	SOD-323	40V/500 mA
Diodes Inc.	SDM20U40	Schottky	SOD-523 (1.2 mm × 0.8 mm × 0.6 mm)	40V/200 mA
On Semiconductor	NSR0340V2T1G	Schottky	SOD-523 (1.2 mm × 0.8 mm × 0.6 mm)	40V/250 mA
On Semiconductor	NSR0240V2T1G	Schottky	SOD-523 (1.2 mm × 0.8 mm × 0.6 mm)	40V/250 mA

LAYOUT GUIDELINES

The LM3532 contains an inductive boost converter which sees a high switched voltage (up to 40V) at the SW pin, and a step current (up to 1A) through the Schottky diode and output capacitor each switching cycle. The high switching voltage can create interference into nearby nodes due to electric field coupling ($I = CdV/dt$). The large step current through the

diode, and the output capacitor can cause a large voltage spike at the SW pin and the OVP pin due to parasitic inductance in the step current conducting path ($V = Ldi/dt$). Board layout guidelines are geared towards minimizing this electric field coupling and conducted noise. *Figure 16* highlights these two noise generating components.

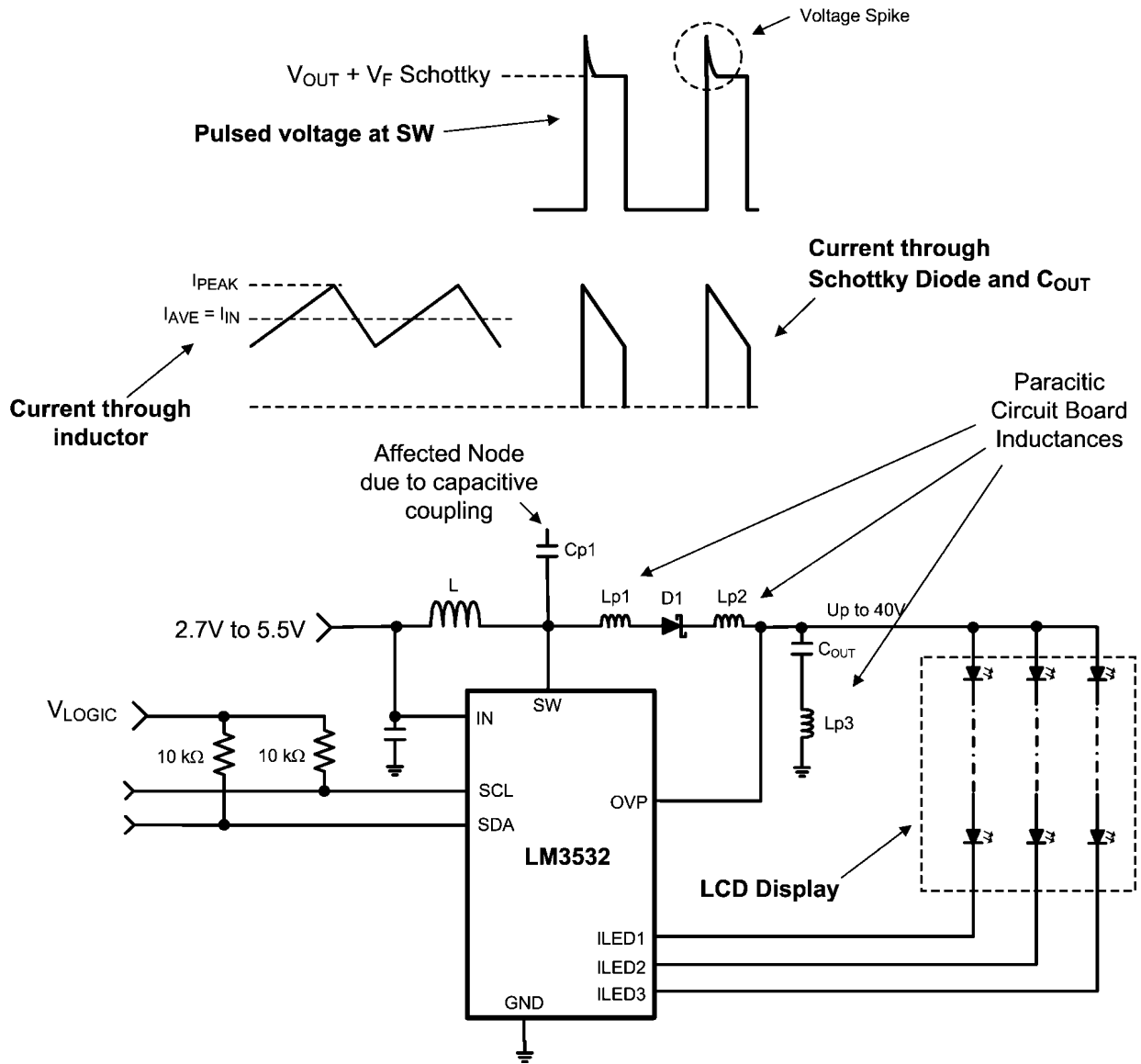

301154101

FIGURE 16. LM3532's Boost Converter Showing Pulsed Voltage at SW (High dV/dt) and Current Through Schottky and COUT (High dI/dt)

The following lists the main (layout sensitive) areas of the LM3532 in order of decreasing importance:

Output Capacitor

- Schottky Cathode to COUT+
- COUT- to GND

Schottky Diode

- SW Pin to Schottky Anode
- Schottky Cathode to COUT+

Inductor

- SW Node PCB capacitance to other traces

Input Capacitor

- CIN+ to IN pin
- CIN- to GND

Output Capacitor Placement

The output capacitor is in the path of the inductor current discharge current. As a result, C_{OUT} sees a high current step from 0 to I_{PEAK} each time the switch turns off and the Schottky diode turns on. Typical turn-off/turn-on times are around 5ns. Any inductance along this series path from the cathode of the diode through C_{OUT} and back into the LM3532's GND pin will contribute to voltage spikes ($V_{SPIKE} = L_{PX} \times di/dt$) at SW and OUT which can potentially over-voltage the SW pin, or feed through to GND. To avoid this, C_{OUT+} must be connected as close as possible to the Cathode of the Schottky diode and C_{OUT-} must be connected as close as possible to the LM3532's GND bump. The best placement for C_{OUT} is on the same layer as the LM3532 so as to avoid any vias that will add extra series inductance (see Layout Examples).

Schottky Diode Placement

The Schottky diode is in the path of the inductor current discharge. As a result the Schottky diode sees a high current step from 0 to I_{PEAK} each time the switch turns off and the diode turns on. Any inductance in series with the diode will cause a voltage spike ($V_{SPIKE} = L_{PX} \times di/dt$) at SW and OUT which can potentially over-voltage the SW pin, or feed through to VOUT and through the output capacitor and into GND. Connecting the anode of the diode as close as possible to the SW pin and the cathode of the diode as close as possible to COUT+ will reduce the inductance (L_{PX}) and minimize these voltage spikes (Layout Examples).

Inductor Placement

The node where the inductor connects to the LM3532's SW bump has 2 issues. First, a large switched voltage (0 to $V_{OUT} + V_{F_SCHOTTKY}$) appears on this node every switching cycle. This switched voltage can be capacitively coupled into nearby nodes. Second, there is a relatively large current (input current) on the traces connecting the input supply to the inductor and connecting the inductor to the SW bump. Any resistance in this path can cause large voltage drops that will negatively affect efficiency.

To reduce the capacitively coupled signal from SW into nearby traces, the SW bump to inductor connection must be minimized in area. This limits the PCB capacitance from SW to other traces. Additionally, other nodes need to be routed away from SW and not directly beneath. This is especially true for high impedance nodes that are more susceptible to capacitive coupling such as (SCL, SDA, HWEN, PWM, and possibly ASL1 and ALS2). A GND plane placed directly below SW will help isolate SW and dramatically reduce the capacitance from SW into nearby traces.

To limit the trace resistance of the VBATT to inductor connection and from the inductor to SW connection, use short, wide traces (see Layout Examples).

Input Capacitor Selection and Placement

The input bypass capacitor filters the inductor current ripple, and the internal MOSFET driver currents during turn on of the power switch.

The driver current requirement can be a few hundred mA's with 5ns rise and fall times. This will appear as high di/dt current pulses coming from the input capacitor each time the switch turns on. Close placement of the input capacitor to the IN pin and to the GND pin is critical since any series inductance between IN and C_{IN+} or C_{IN-} and GND can create voltage spikes that could appear on the V_{IN} supply line and in the GND plane.

Close placement of the input bypass capacitor at the input side of the inductor is also critical. The source impedance (inductance and resistance) from the input supply, along with the input capacitor of the LM3532, form a series RLC circuit. If the output resistance from the source (R_S) is low enough the circuit will be underdamped and will have a resonant frequency (typically the case). Depending on the size of L_S the resonant frequency could occur below, close to, or above the LM3532's switching frequency. This can cause the supply current ripple to be:

- approximately equal to the inductor current ripple when the resonant frequency occurs well above the LM3532's switching frequency;
- greater than the inductor current ripple when the resonant frequency occurs near the switching frequency; or
- less than the inductor current ripple when the resonant frequency occurs well below the switching frequency.

Figure 17 shows this series RLC circuit formed from the output impedance of the supply and the input capacitor. The circuit is re-drawn for the AC case where the V_{IN} supply is replaced with a short to GND and the LM3532 + Inductor is replaced with a current source (ΔI_L).

Equation 1 is the criteria for an underdamped response. Equation 2 is the resonant frequency. Equation 3 is the approximated supply current ripple as a function of L_S , R_S , and C_{IN} .

As an example, consider a 3.6V supply with 0.1 Ω of series resistance connected to C_{IN} through 50 nH of connecting traces. This results in an underdamped input filter circuit with a resonant frequency of 712 kHz. Since the switching frequency lies near to the resonant frequency of the input RLC network, the supply current is probably larger than the inductor current ripple. In this case, using equation 3 from *Figure 17*, the supply current ripple can be approximated as 1.68 times the inductor current ripple. Increasing the series inductance (L_S) to 500 nH causes the resonant frequency to move to around 225 kHz and the supply current ripple to be approximately 0.25 times the inductor current ripple.

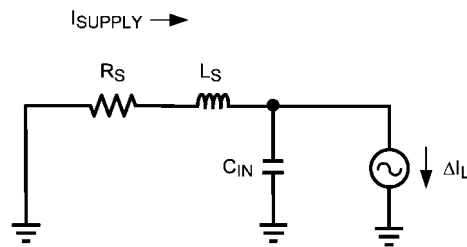
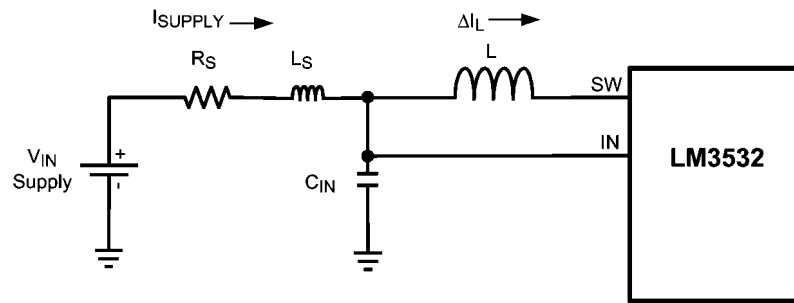

1. $\frac{1}{L_S \times C_{IN}} > \frac{R_S^2}{4 \times L_S^2}$
2. $f_{\text{RESONANT}} = \frac{1}{2\pi \sqrt{L_S \times C_{IN}}}$
3. $I_{\text{SUPPLYRIPPLE}} \approx \Delta I_L \times \frac{1}{2\pi \times 500 \text{ kHz} \times C_{IN} \sqrt{R_S^2 + \left(2\pi \times 500 \text{ kHz} \times L_S - \frac{1}{2\pi \times 500 \text{ kHz} \times C_{IN}}\right)^2}}$

301154102

FIGURE 17. Input RLC Network

Example Layouts

The following figures show example layouts which apply the required (proper) layout guidelines. These figures should be used as guides for laying out the LM3532's boost circuit.

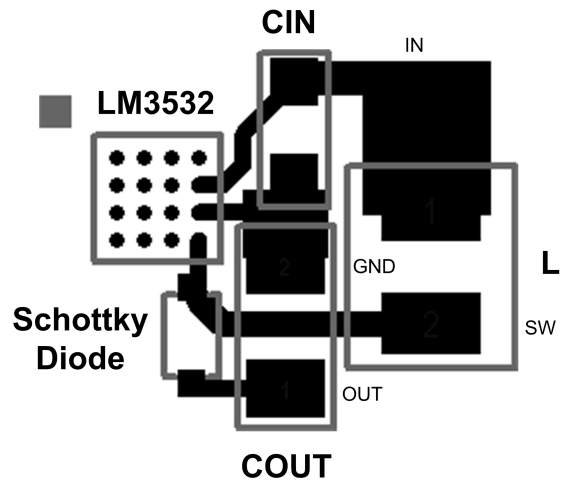

30115485

FIGURE 18. Layout Example #1

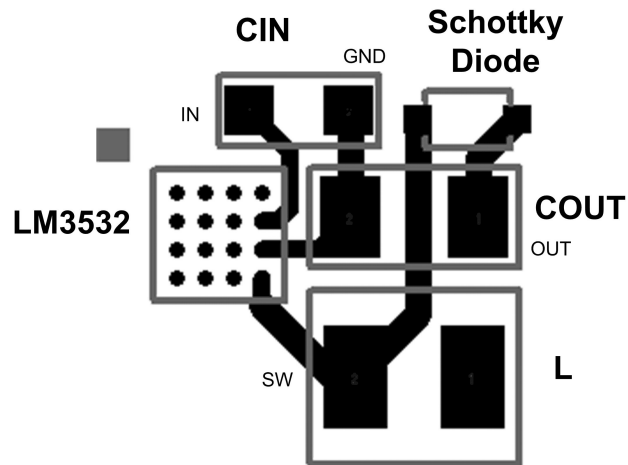

30115486

FIGURE 19. Layout Example #2

Physical Dimensions inches (millimeters) unless otherwise noted

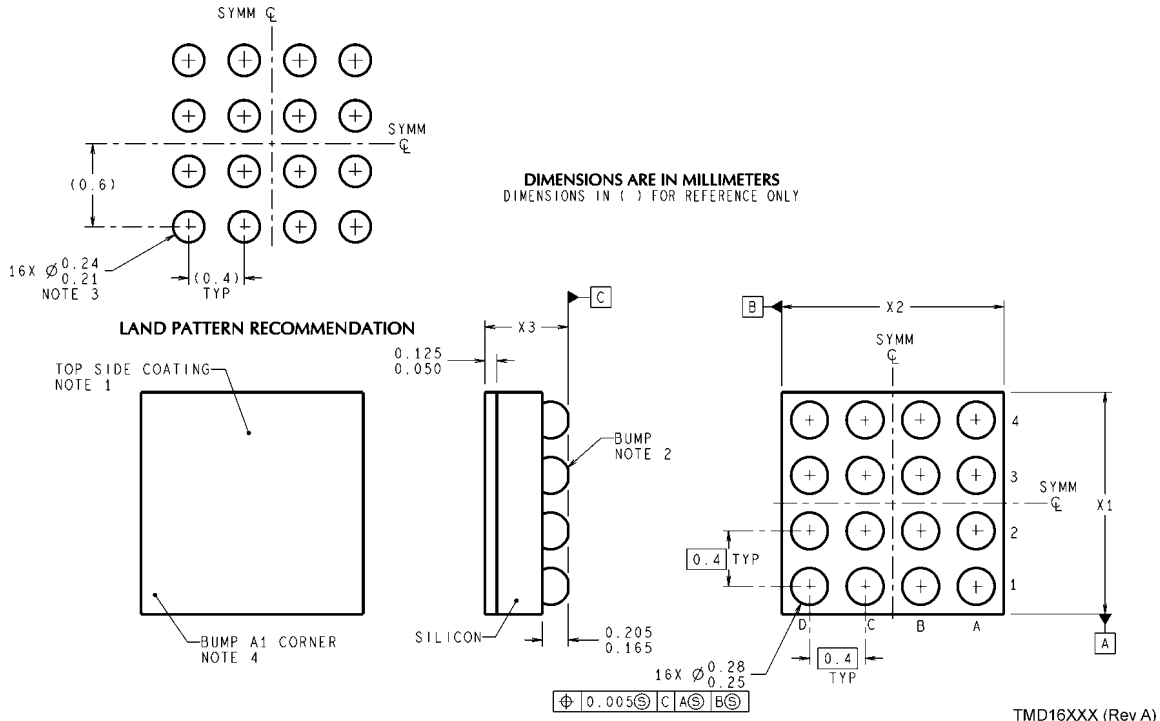

16-Bump Thin Micro SMD Package
For Ordering, Refer to Ordering Information Table
NS Package Number TMD16
X1 = 1.745 mm (\pm 0.1 mm), X2 = 1.845 mm (\pm 0.1 mm), X3 = 0.600 mm

Notes

LM3532

Notes

For more National Semiconductor product information and proven design tools, visit the following Web sites at:
www.national.com

Products		Design Support	
Amplifiers	www.national.com/amplifiers	WEBENCH® Tools	www.national.com/webench
Audio	www.national.com/audio	App Notes	www.national.com/appnotes
Clock and Timing	www.national.com/timing	Reference Designs	www.national.com/refdesigns
Data Converters	www.national.com/adc	Samples	www.national.com/samples
Interface	www.national.com/interface	Eval Boards	www.national.com/evalboards
LVDS	www.national.com/lvds	Packaging	www.national.com/packaging
Power Management	www.national.com/power	Green Compliance	www.national.com/quality/green
Switching Regulators	www.national.com/switchers	Distributors	www.national.com/contacts
LDOs	www.national.com/lido	Quality and Reliability	www.national.com/quality
LED Lighting	www.national.com/led	Feedback/Support	www.national.com/feedback
Voltage References	www.national.com/vref	Design Made Easy	www.national.com/easy
PowerWise® Solutions	www.national.com/powerwise	Applications & Markets	www.national.com/solutions
Serial Digital Interface (SDI)	www.national.com/sdi	Mil/Aero	www.national.com/milaero
Temperature Sensors	www.national.com/tempensors	SolarMagic™	www.national.com/solarmagic
PLL/VCO	www.national.com/wireless	PowerWise® Design University	www.national.com/training

THE CONTENTS OF THIS DOCUMENT ARE PROVIDED IN CONNECTION WITH NATIONAL SEMICONDUCTOR CORPORATION ("NATIONAL") PRODUCTS. NATIONAL MAKES NO REPRESENTATIONS OR WARRANTIES WITH RESPECT TO THE ACCURACY OR COMPLETENESS OF THE CONTENTS OF THIS PUBLICATION AND RESERVES THE RIGHT TO MAKE CHANGES TO SPECIFICATIONS AND PRODUCT DESCRIPTIONS AT ANY TIME WITHOUT NOTICE. NO LICENSE, WHETHER EXPRESS, IMPLIED, ARISING BY ESTOPPEL OR OTHERWISE, TO ANY INTELLECTUAL PROPERTY RIGHTS IS GRANTED BY THIS DOCUMENT.

TESTING AND OTHER QUALITY CONTROLS ARE USED TO THE EXTENT NATIONAL DEEMS NECESSARY TO SUPPORT NATIONAL'S PRODUCT WARRANTY. EXCEPT WHERE MANDATED BY GOVERNMENT REQUIREMENTS, TESTING OF ALL PARAMETERS OF EACH PRODUCT IS NOT NECESSARILY PERFORMED. NATIONAL ASSUMES NO LIABILITY FOR APPLICATIONS ASSISTANCE OR BUYER PRODUCT DESIGN. BUYERS ARE RESPONSIBLE FOR THEIR PRODUCTS AND APPLICATIONS USING NATIONAL COMPONENTS. PRIOR TO USING OR DISTRIBUTING ANY PRODUCTS THAT INCLUDE NATIONAL COMPONENTS, BUYERS SHOULD PROVIDE ADEQUATE DESIGN, TESTING AND OPERATING SAFEGUARDS.

EXCEPT AS PROVIDED IN NATIONAL'S TERMS AND CONDITIONS OF SALE FOR SUCH PRODUCTS, NATIONAL ASSUMES NO LIABILITY WHATSOEVER, AND NATIONAL DISCLAIMS ANY EXPRESS OR IMPLIED WARRANTY RELATING TO THE SALE AND/OR USE OF NATIONAL PRODUCTS INCLUDING LIABILITY OR WARRANTIES RELATING TO FITNESS FOR A PARTICULAR PURPOSE, MERCHANTABILITY, OR INFRINGEMENT OF ANY PATENT, COPYRIGHT OR OTHER INTELLECTUAL PROPERTY RIGHT.

LIFE SUPPORT POLICY

NATIONAL'S PRODUCTS ARE NOT AUTHORIZED FOR USE AS CRITICAL COMPONENTS IN LIFE SUPPORT DEVICES OR SYSTEMS WITHOUT THE EXPRESS PRIOR WRITTEN APPROVAL OF THE CHIEF EXECUTIVE OFFICER AND GENERAL COUNSEL OF NATIONAL SEMICONDUCTOR CORPORATION. As used herein:

Life support devices or systems are devices which (a) are intended for surgical implant into the body, or (b) support or sustain life and whose failure to perform when properly used in accordance with instructions for use provided in the labeling can be reasonably expected to result in a significant injury to the user. A critical component is any component in a life support device or system whose failure to perform can be reasonably expected to cause the failure of the life support device or system or to affect its safety or effectiveness.

National Semiconductor and the National Semiconductor logo are registered trademarks of National Semiconductor Corporation. All other brand or product names may be trademarks or registered trademarks of their respective holders.

Copyright© 2011 National Semiconductor Corporation

For the most current product information visit us at www.national.com



National Semiconductor Americas Technical Support Center
 Email: support@nsc.com
 Tel: 1-800-272-9959

National Semiconductor Europe Technical Support Center
 Email: europe.support@nsc.com

National Semiconductor Asia Pacific Technical Support Center
 Email: ap.support@nsc.com

National Semiconductor Japan Technical Support Center
 Email: jpn.feedback@nsc.com