



SPX3819

500 mA, Low-Noise LDO Voltage Regulator (ADVANCED INFORMATION)

FEATURES

- Ultra-Low Noise Output LDO
- 1% Initial Accuracy At 500mA
- Very Low Quiescent Current
- Low Dropout Voltage (300mV At 500mA)
- Current & Thermal Limiting
- Reverse-Battery Protection
- Several Fix Output Voltages, 2.5, 3.3, 5.0V & Adjustable
- Zero Off-Mode Current
- Packages offered SO-8, TO-263, SOT-223, SOT-23 & TO-220
- Pin Compatible to MIC5209 (Fixed Option Only)

APPLICATIONS

- Battery Powered Systems
- Cordless Telephones
- Radio Control Systems
- Portable/Palm Top/Notebook Computers
- Portable Consumer Equipment
- Portable Instrumentation
- Bar Code Scanners
- SMPS Post-Regulator

PRODUCT DESCRIPTION

The SPX3819 is a low powered positive voltage regulator with ultra low noise output and very low voltage dropout. In addition, this device offers very low quiescent current of approximately 800uA at 100mA output. The SPX3819 initial tolerance is less than 1% max with logic compatible ON/OFF switching input. The unique feature of SPX3819 includes a reference bypass pin for the best results of low noise.

This device is an excellent choice for the use in battery-powered applications such as cordless telephones, radio control systems, and portable computers. When disable power consumption drop to nearly zero. This device has a very low output temperature coefficient, making it a low power voltage reference. The key features include protection against reversed battery, fold-back current limiting, and automotive load dump protection.

The SPX3819 is available in several fixed voltages 2.5V, 3.3V, 5.0V or adjustable output. This device is offered in SO-8, 3 and 5 pin TO-263, SOT-223, 5-pin SOT-23 & 3-pin TO-220. These packages offer all the features and adjustable output.

MARKING INFORMATION

(SOT-23 Only)

Voltage	Marking
ADJ	A0XX
2.5V	A8XX
3.3V	A1XX
5.0V	A9XX

XX Production Reference Code.

PIN CONNECTIONS

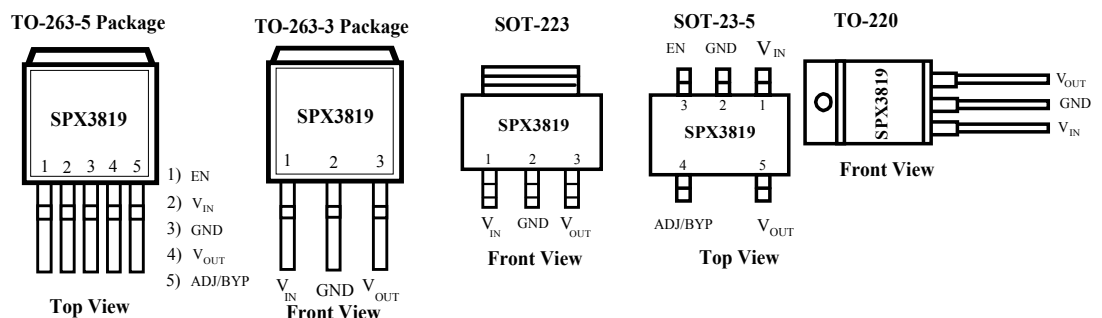

ABSOLUTE MAXIMUM RATINGS

Power Dissipation..... Internally Limited
 Lead Temp. (Soldering, 5 Seconds) 260°C
 Operating Junction Temperature Range -40°C to +125°C
 Input Supply Voltage.....-20V to +20V
 Enable Input Voltage.....-20V to +20V

RECOMMENDED OPERATING CONDITIONS

Input Voltage..... +2.5V to+16V
 Operating Junction Temperature Range -40°C to +125°C
 Enable Input Voltage..... 0V to V_{IN}

ELECTRICAL CHARACTERISTICS

$T_J = 25^\circ\text{C}$, $V_{OUT} + 1\text{V}$, $I_L = 100\mu\text{A}$, $C_L = 1\mu\text{F}$, and $V_{ENABLE} \geq 2.4\text{V}$. Unless otherwise specified **boldface** applies over the junction temperature range

Parameter	Test Conditions	Typ	Min	Max	Units
Output Voltage Tolerance	$I_L = 100\mu\text{A}$ $I_L = 500\mu\text{A}$		-1 -2	+1 +2	%
Output Voltage Temperature Coef. ($\Delta V/\Delta T$)		57			ppm/°C
Line Regulation ($\Delta V/V$)	$V_{IN} = V_{OUT} + 1\text{V}$ to 16V	0.04		0.1	%/V
Load Regulation ($\Delta V/V$)	$I_L = 0.1\text{mA}$ to 500mA	0.05		0.2	%
Dropout Voltage ($V_{IN} - V_O$)	$I_L = 100\mu\text{A}$	10		60 80	mV
	$I_L = 50\text{mA}$	125		175 250	
	$I_L = 150\text{mA}$	180		350 450	
	$I_L = 500\text{mA}$	340		550 700	
Quiescent Current (I_{GND})	$V_{ENABLE} \leq 0.6\text{V}$	0.05		3	μA
	$V_{ENABLE} \leq 0.25\text{V}$	0.10		8	
Ground Pin Current (I_{GND})	$I_L = 100\mu\text{A}$	110		150 190	μA
	$I_L = 50\text{mA}$	360		650 900	
	$I_L = 150\text{mA}$	1.3		2.0 2.5	mA
	$I_L = 500\text{mA}$	13.0		25.0 30.0	
Ripple Rejection (PSRR)		55			dB
Current Limit (I_{LIMIT})	$V_{OUT} = 0\text{V}$	800		950	mA
Output Noise (e_{NO})	$I_L = 50\text{mA}$, $C_L = 1.0\mu\text{F}$ (10Hz – 100KHz)	390			μV_{RMS}
Input Voltage Level Logic Low (V_{IL})	OFF			0.6	V
Input Voltage Level Logic High (V_{IH})	ON		2		V
ENABLE Input Current	$V_{IL} \leq 0.6\text{V}$	0.01		2	μA
	$V_{IH} \geq 2.0\text{V}$	2		20	
Thermal Resistance	TO-220	Junction to Tab		3.0	°C/W
		Junction to Ambient		60	
	DD Package	Junction to Tab		3.0	
		Junction to Ambient		60	
	SOT-223	Junction to Tab		15	
		Junction to Ambient		156	
	SOT-23-5	Junction to Tab		N/A	
		Junction to Ambient		220	
	SO-8	Junction to Tab		N/A	
		Junction to Ambient		180	

TYPICAL APPLICATION

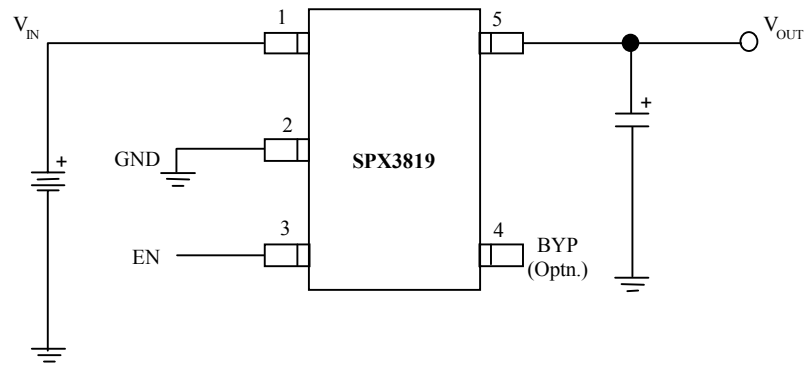

ENABLE may be tied directly to V_{IN}

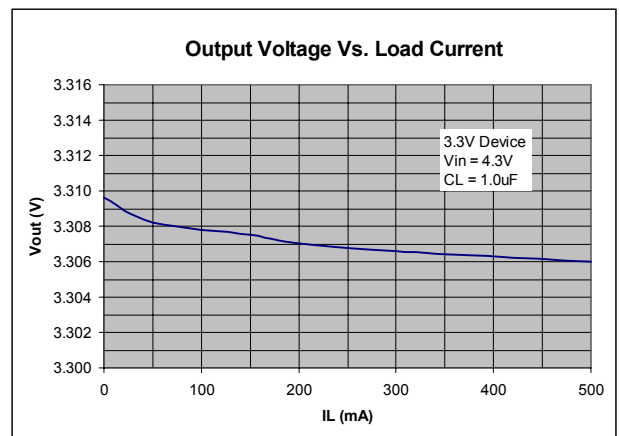
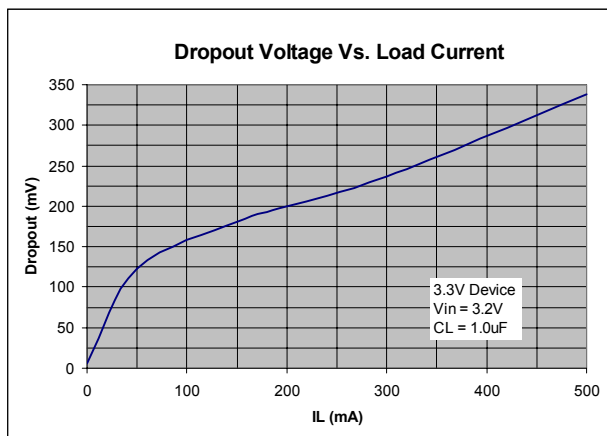
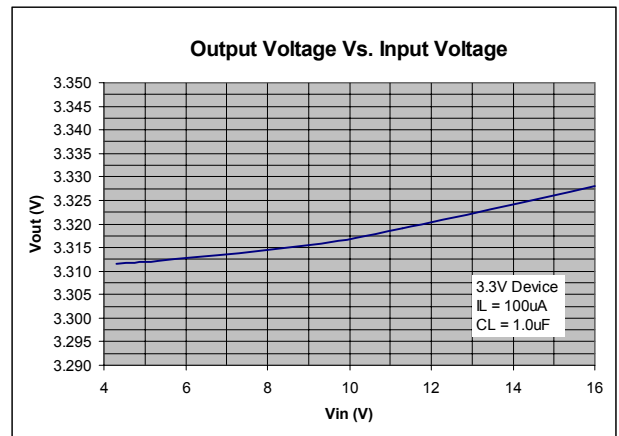
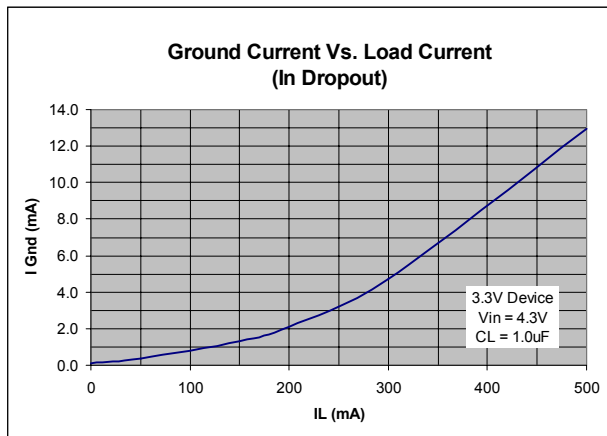
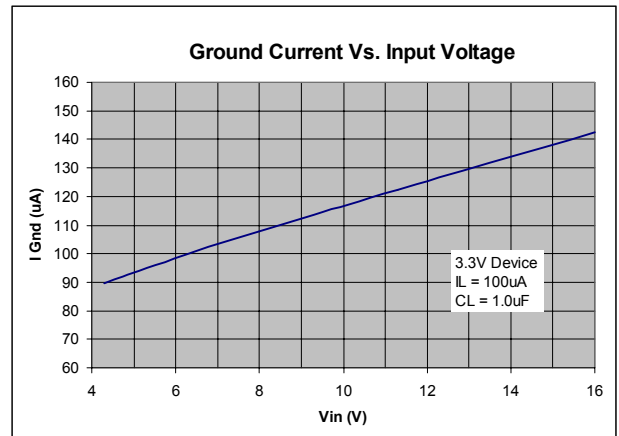
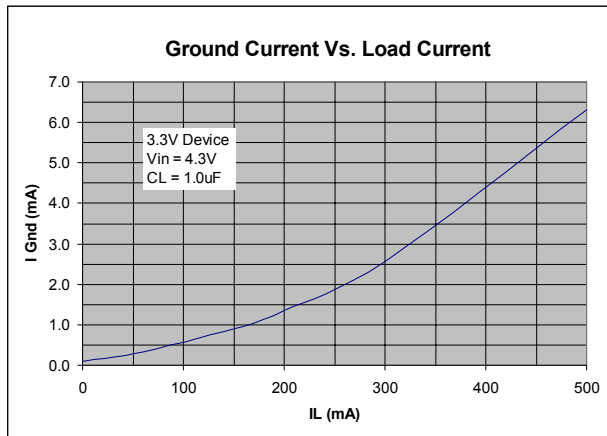

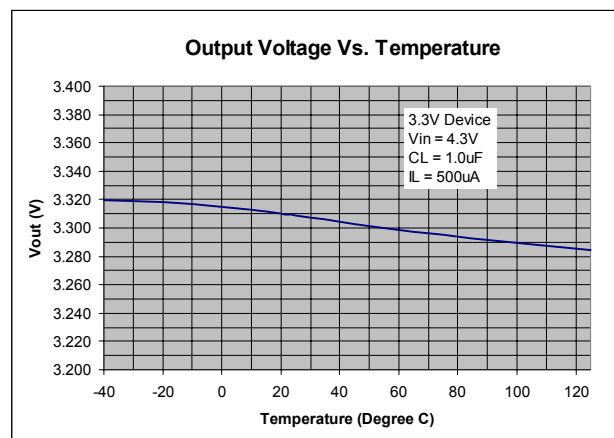
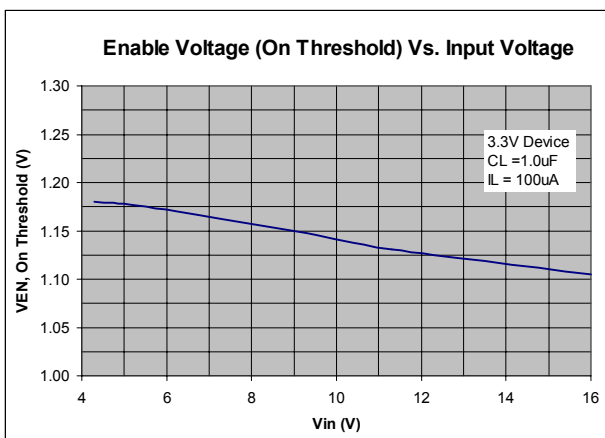
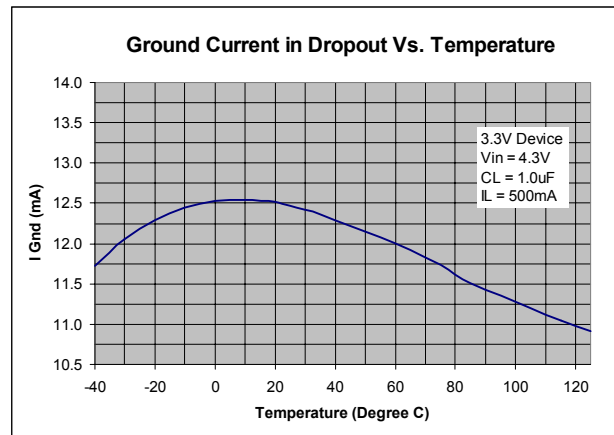
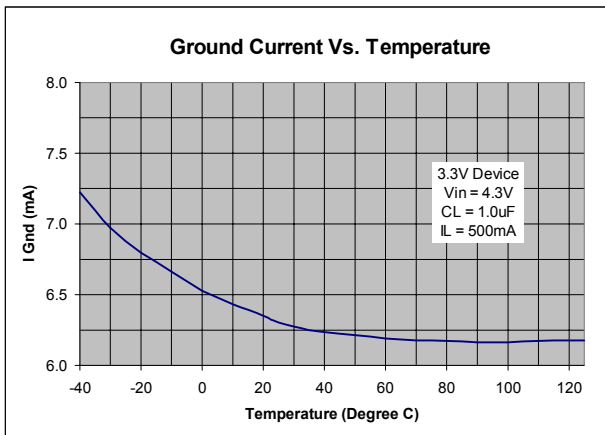
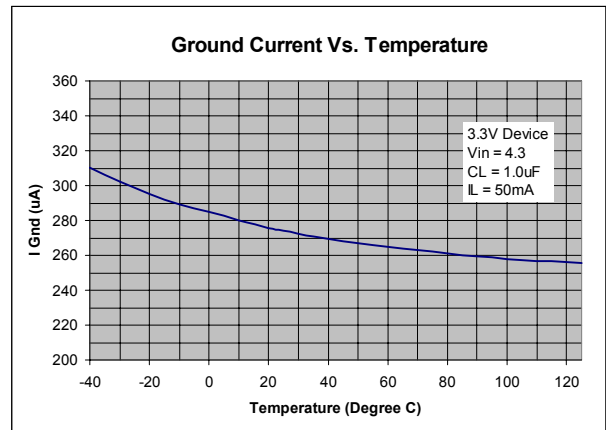
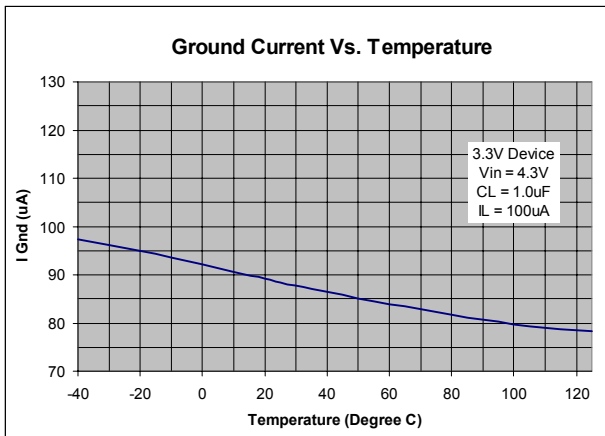

Line Transient Response

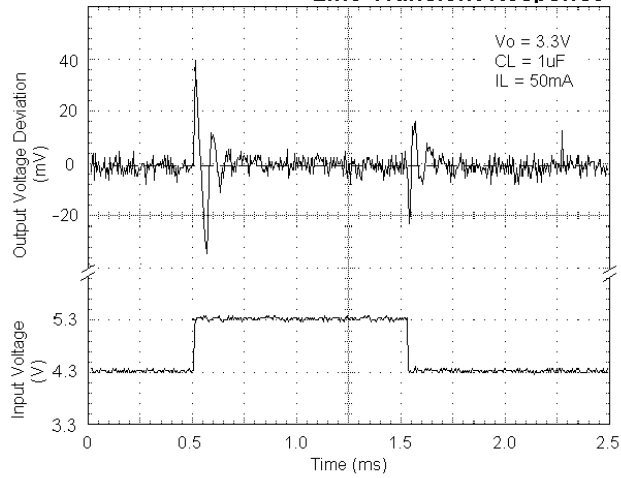

Load Transient Response

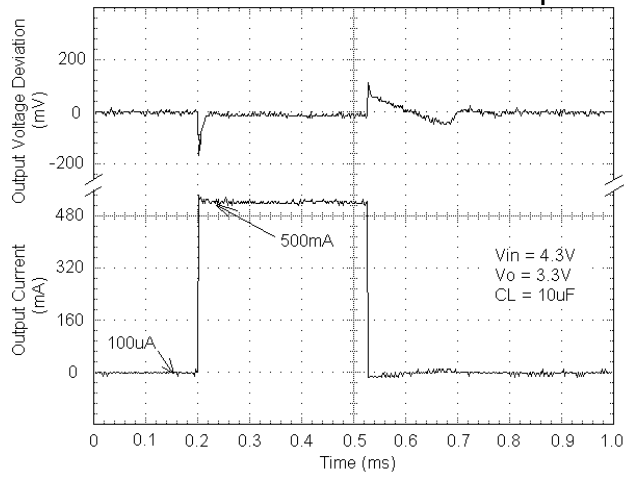

Switching Characteristics

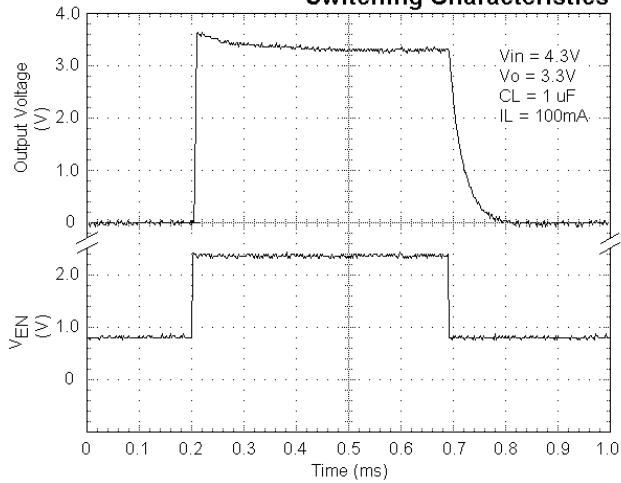

Application Hints

The SPX3819 requires an output capacitor for device stability. The value required varies greatly depending upon the application circuit. The high frequency characteristics of electrolytic capacitors depend greatly on the type and also on the manufacturer. Sometimes bench testing is the only means to determine the proper capacitor type and value. The high quality 2.2μF aluminum electrolytic capacitor covers all general application circuits; this stability can be obtained with a tantalum electrolytic value of 1μF.

In general, linear regulator stability decreases with higher output currents. In most applications the SPX3819 is operating at few milliamps. In these applications the output capacitance can be further reduced. For example, when the regulator is running at 10mA output current the output capacitance value is half compared to the same regulator that is running at 150mA.

With the SPX3819 adjustable regulator, the minimum value of output capacitance is a function of the output voltage. The value decreases with higher output voltages, since the closed loop gain is increased.

Typical Applications Circuits

The SPX3819 provides access to the internal reference. A 10μF capacitor on the Ref BYP pin will provide a significant reduction in output noise. This pin may be left unconnected if the output noise is not a major concern. The SPX3819 start-up speed is inversely proportional to the size of its capacitor. Applications requiring a slow ramp-up of output voltage should consider larger values of C_{BYP}. If the rapid turn-ON is necessary, omit bypass capacitor.

Figure 1 shows SPX3819 standard application circuit. The EN (enable) pin is pulled high (>2.0V) to enable the regulator. To disable the regulator, EN < 0.6V.

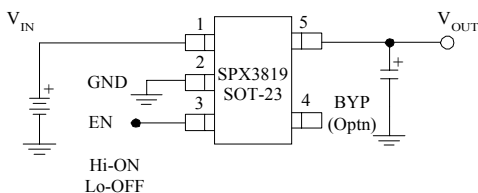

Top View

Fig. 1

The SPX3819 in figure 2 shows adjustable output voltage configuration. Two resistors set the output voltage. The formula for output voltage is:

$$V_{OUT} = 1.235V \times \left[1 + \frac{R1}{R2} \right]$$

Resistor values are not critical as the Adj pin has high input impedance, for best results use resistors of 47kΩ or less. A capacitor for Adj to ground will provide improved noise performance.

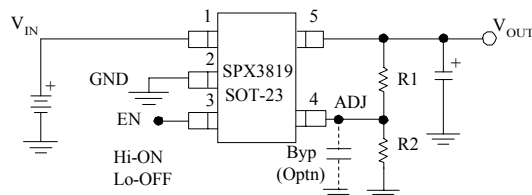

Top View

Fig. 2

PACKAGE DRAWING
SOIC-8 (S)

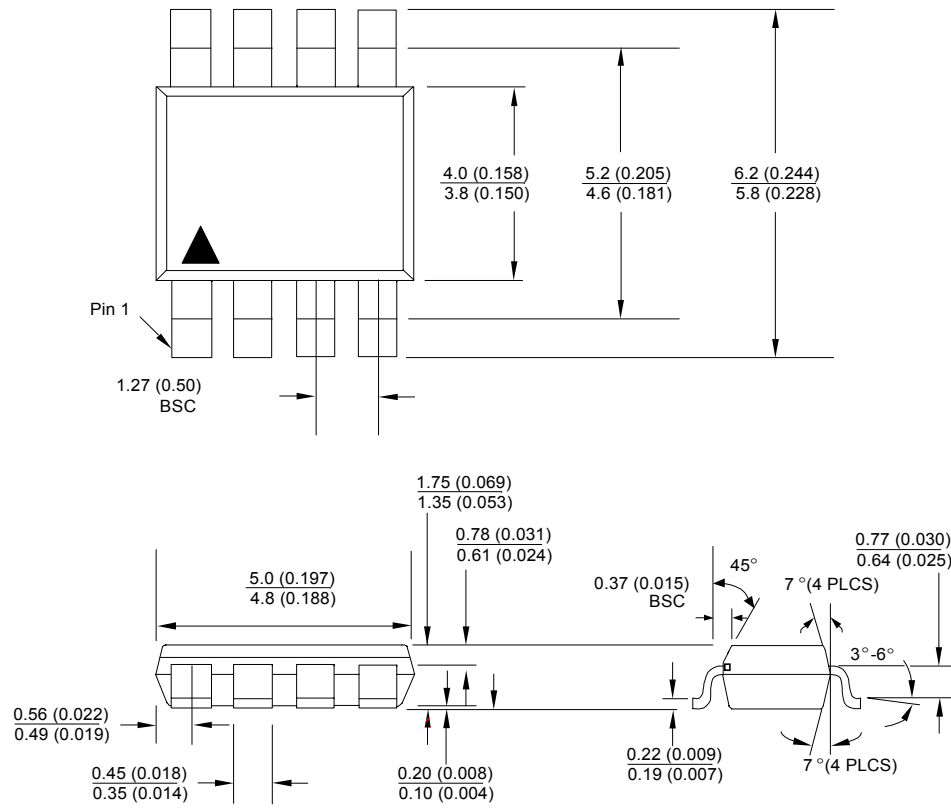

PACKAGE DRAWING
TO-263-3L (T)

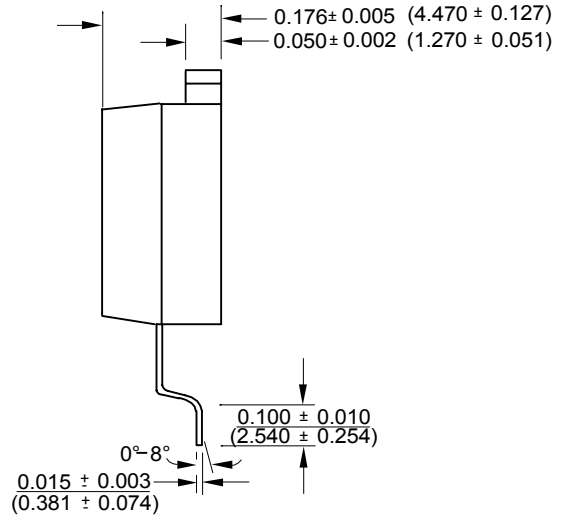
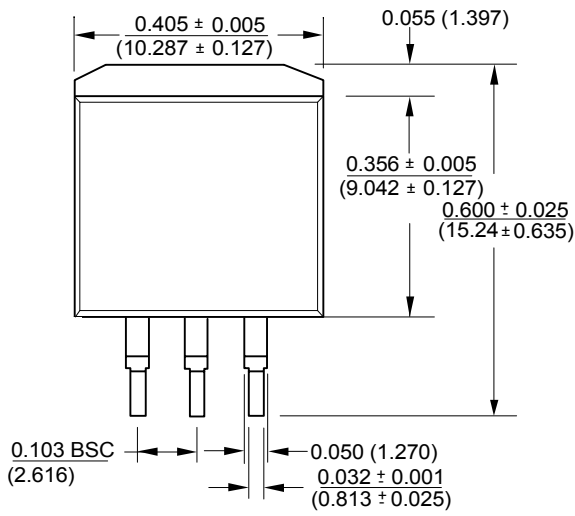

PACKAGE DRAWING
TO-263-5L (T)

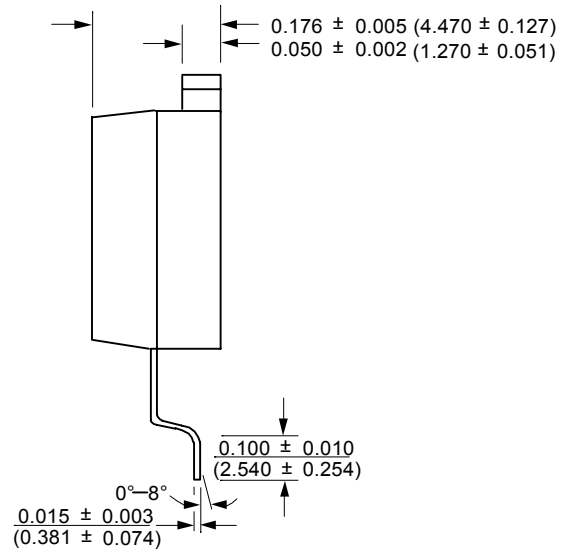
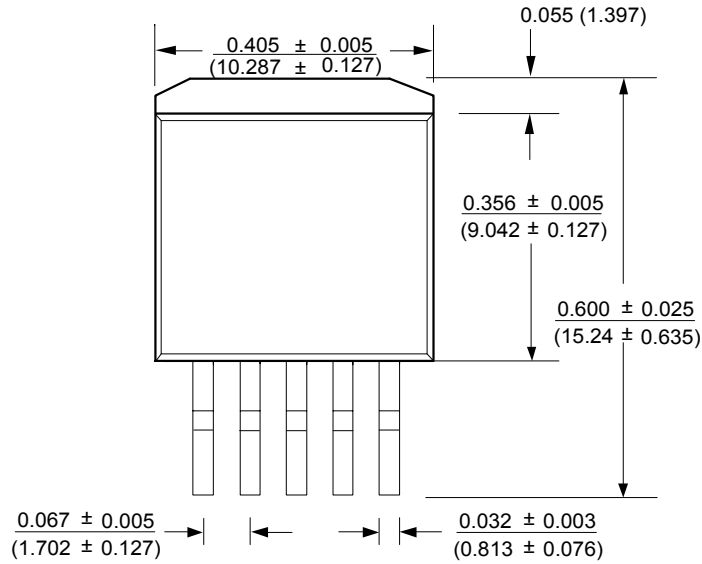

PACKAGE DRAWING
SOT-223-3L (M3)

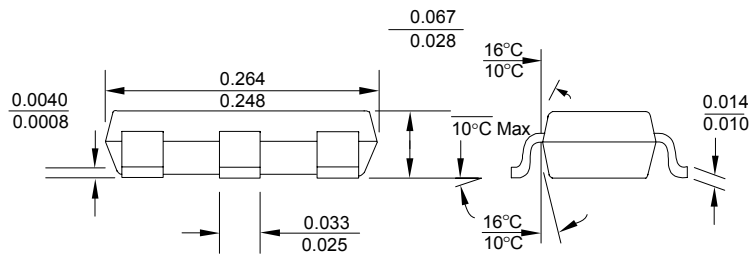
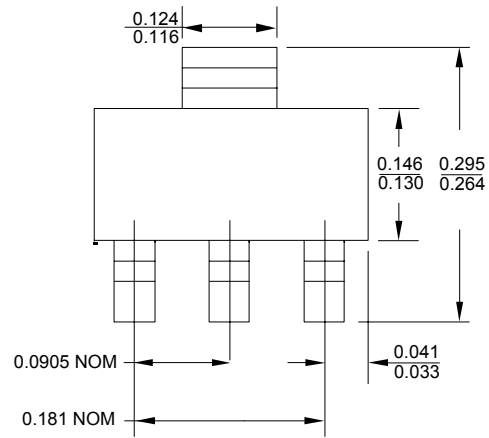

PACKAGE DRAWING
SOT-23-5L (M5)

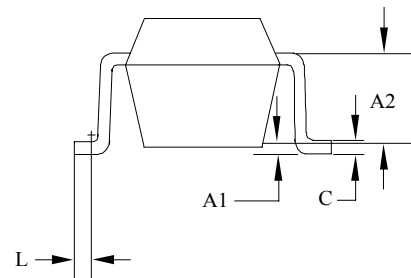
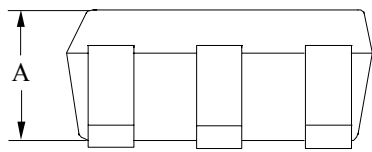
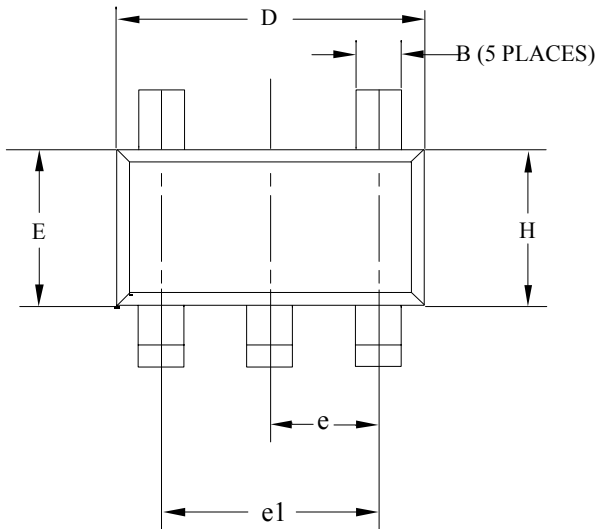

SYMBOL	MILLIMETERS		INCHES	
	MIN.	MAX.	MIN.	MAX.
A	0.90	1.30	.035	.051
A1	0	0.10	0	.004
A2	0.80 REF		.0315 REF	
B	0.30	0.50	.012	.019
C	0.10	0.35	.004	.0137
D	2.70	3.10	.106	.122
E	1.40	1.80	.055	.071
e	0.95 BSC.		.037 BSC.	
e1	1.70	2.10	.066	.082
H	2.50	3.00	.098	.118
L	MIN 0.2		MIN .0078	

NOTE:

1. REFER TO APPLICABLE
2. CONTROLLING DIMENTION : MILLIMETER
3. PACKAGE SURFACE FINISHING TO BE SMOOTH FINISH.

PACKAGE DRAWING
TO-220-3L (U)

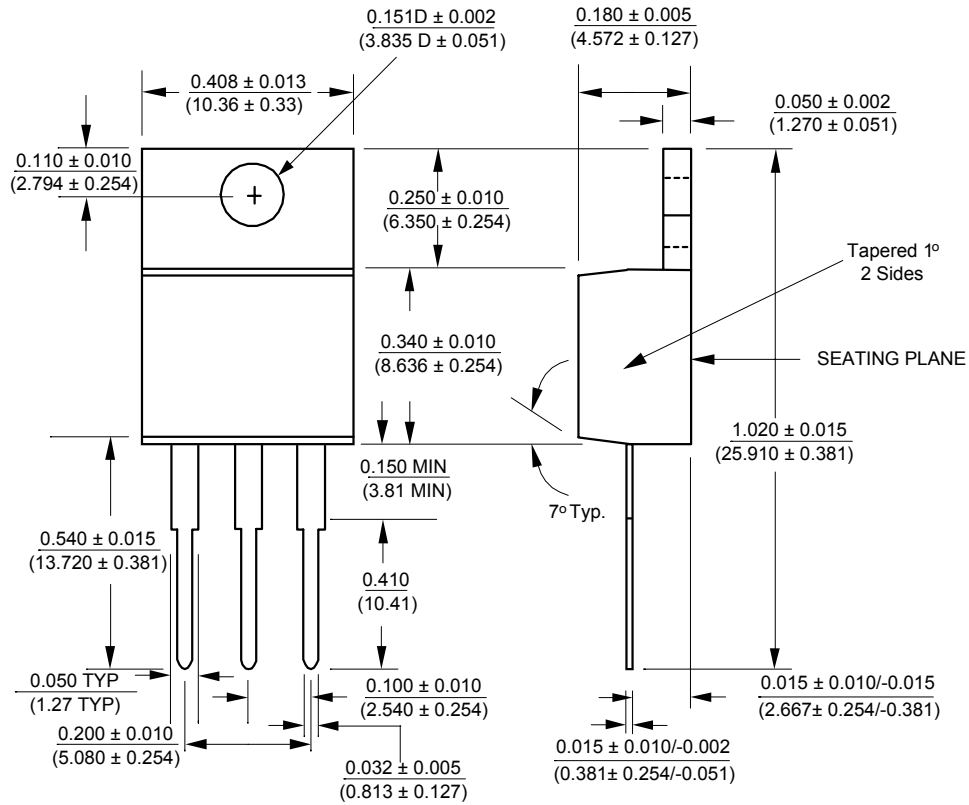

ORDERING INFORMATION

Ordering No.	Output Voltage	Packages
SPX3819S	Adj	8 Lead SOIC
SPX3819S-2.5	2.5V	8 Lead SOIC
SPX3819S-3.3	3.3V	8 Lead SOIC
SPX3819S-5.0	5.0V	8 Lead SOIC
SPX3819T	Adj	3 Lead TO-263
SPX3819T-2.5	2.5V	3 Lead TO-263
SPX3819T-3.3	3.3V	3 Lead TO-263
SPX3819T-5.0	3.0V	3 Lead TO-263
SPX3819T5	Adj	5 Lead TO-263
SPX3819T5-2.5	2.5V	5 Lead TO-263
SPX3819T5-3.3	3.3V	5 Lead TO-263
SPX3819T5-5.0	5.0V	5 Lead TO-263
SPX3819M3	Adj	3 Lead SOT-223
SPX3819M3-2.5	2.5V	3 Lead SOT-223
SPX3819M3-3.3	3.3V	3 Lead SOT-223
SPX3819M3-5.0	5.0V	3 Lead SOT-223
SPX3819M5	Adj	5 Lead SOT-23
SPX3819M5-2.5	2.5V	5 Lead SOT-23
SPX3819M5-3.3	3.3V	5 Lead SOT-23
SPX3819M5-5.0	5.0V	5 Lead SOT-23
SPX3819U	Adj	3 Lead SOT-220
SPX3819U-2.5	2.5V	3 Lead SOT-220
SPX3819U-3.3	3.3V	3 Lead SOT-220
SPX3819U-5.0	5.0V	3 Lead SOT-220



SIGNAL PROCESSING EXCELLENCE

Sipex Corporation

Headquarters and Main Offices:

22 Linnell Circle
Billerica, MA 01821
TEL: (978) 667-8700
FAX: (978) 670-9001
e-mail: sales@sipex.com

233 South Hillview Drive
Milpitas, CA 95035
TEL: (408) 935-7600
FAX: (408) 934-7500

Sipex Corporation reserves the right to make changes to any products described herein. Sipex does not assume any liability arising out of the application or use of any product or circuit described hereing; neither does it convey any license under its patent rights nor the rights of others.