

MITSUBISHI DIODE MODULES
RM10TA-24,-2H

HIGH VOLTAGE MEDIUM POWER GENERAL USE
 INSULATED TYPE

RM10TA-24,-2H

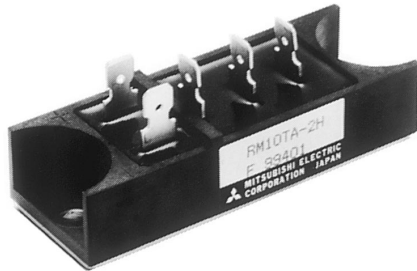

- I_o DC output current 20A
- V_{RRM} Repetitive peak reverse voltage
 1200/1600V

- 3 phase bridge
- Insulated Type
- UL Recognized

Yellow Card No. E80276 (N)
 File No. E80271

APPLICATION

AC motor controllers, DC motor controllers, Battery DC power supplies,
 DC power supplies for control panels, and other general DC power equipment

OUTLINE DRAWING & CIRCUIT DIAGRAM

Dimensions in mm

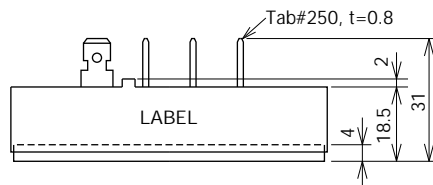
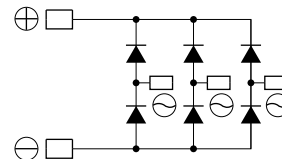
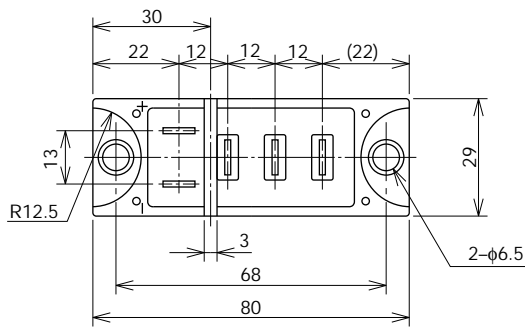

Feb.1999



<http://store.iic.cc/>

RM10TA-24,-2H

HIGH VOLTAGE MEDIUM POWER GENERAL USE
INSULATED TYPE

ABSOLUTE MAXIMUM RATINGS

Symbol	Parameter	Voltage class		Unit
		24	2H	
VRRM	Repetitive peak reverse voltage	1200	1600	V
VRSM	Non-repetitive peak reverse voltage	1350	1700	V
Ea	Recommended AC input voltage	370	440	V

Symbol	Parameter	Conditions	Ratings	Unit
Io	DC output current	Three-phase full wave rectifying circuit, Tc=100°C	20	A
IFSM	Surge (non-repetitive) forward current	One half cycle at 60Hz, peak value	200	A
I ² t	I ² t for fusing	Value for one cycle of surge current	1.7 × 10 ²	A ² s
f	Maximum operating frequency		1000	Hz
Tj	Junction temperature		-40~+150	°C
Tstg	Storage temperature		-40~+125	°C
Viso	Isolation voltage	Charged part to case	2500	V
—	Mounting torque	Mounting screw M6	1.96~2.94	N·m
—	Weight	Typical value	20~30	kg·cm
—	Weight	Typical value	120	g

ELECTRICAL CHARACTERISTICS

Symbol	Parameter	Test conditions	Limits			Unit
			Min.	Typ.	Max.	
IRRM	Repetitive reverse current	Tj=150°C, VRRM applied	—	—	2.0	mA
VFM	Forward voltage	Tj=25°C, IFM=20A, instantaneous meas.	—	—	1.25	V
Rth (j-c)	Thermal resistance	Junction to case	—	—	1.0	°C/W
Rth (c-f)	Contact thermal resistance	Case to fin, conductive grease applied	—	—	0.1	°C/W
—	Insulation resistance	Measured with a 500V megohmmeter between main terminal and case	10	—	—	MΩ

RM10TA-24,-2H

HIGH VOLTAGE MEDIUM POWER GENERAL USE
INSULATED TYPE

PERFORMANCE CURVES

MAXIMUM FORWARD CHARACTERISTIC

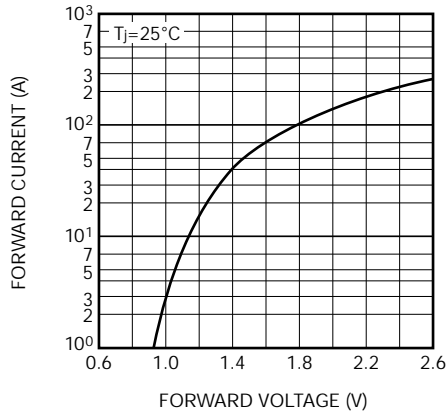

ALLOWABLE SURGE (NON-REPETITIVE) FORWARD CURRENT

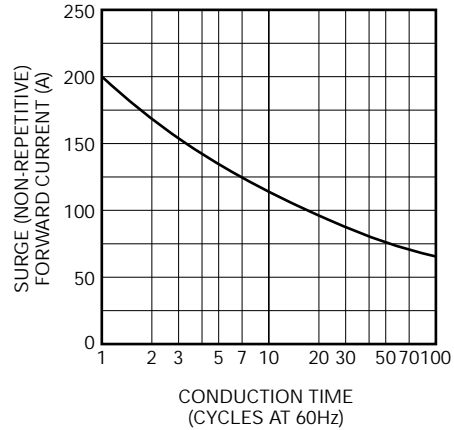

MAXIMUM TRANSIENT THERMAL IMPEDANCE (JUNCTION TO CASE)

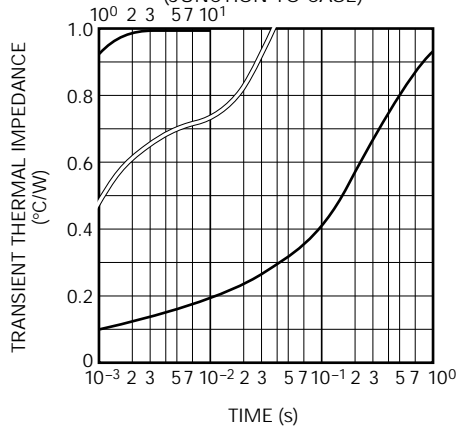

MAXIMUM POWER DISSIPATION

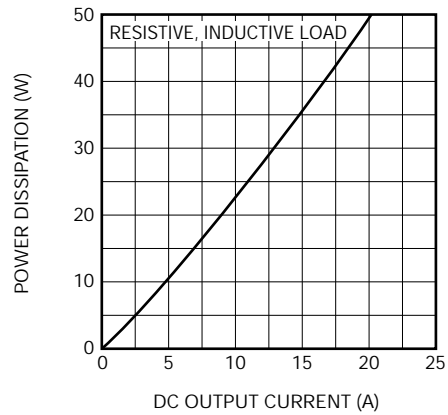

ALLOWABLE CASE TEMPERATURE VS. DC OUTPUT CURRENT

