

Thyristor Modules

Thyristor/Diode Modules

$$I_{TRMS} = 2 \times 450 \text{ A}$$

$$I_{TAVM} = 2 \times 287 \text{ A}$$

$$V_{RRM} = 800-1800 \text{ V}$$

V_{RSM} V_{DSM} V	V_{RRM} V_{DRM} V	Type	Version 1	Version 1
900	800	MCC 250-08io1	MCC 250-08io1	MCD 250-08io1
1300	1200	MCC 250-12io1	MCC 250-12io1	MCD 250-12io1
1500	1400	MCC 250-14io1	MCC 250-14io1	MCD 250-14io1
1700	1600	MCC 250-16io1	MCC 250-16io1	MCD 250-16io1
1900	1800	MCC 250-18io1	MCC 250-18io1	MCD 250-18io1

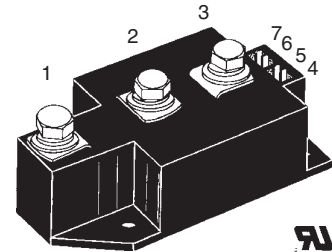

Symbol	Conditions	Maximum Ratings	
I_{TRMS}, I_{FRMS} I_{TAVM}, I_{FAVM}	$T_{VJ} = T_{VJM}$ $T_C = 85^\circ\text{C}; 180^\circ \text{ sine}$	450	A
I_{TSM}, I_{FSM}	$T_{VJ} = 45^\circ\text{C}$ $V_R = 0$	$t = 10 \text{ ms (50 Hz), sine}$ $t = 8.3 \text{ ms (60 Hz), sine}$	9000 9600 A A
$\int i^2 dt$	$T_{VJ} = 45^\circ\text{C}$ $V_R = 0$	$t = 10 \text{ ms (50 Hz), sine}$	405 000 A^2s
		$t = 8.3 \text{ ms (60 Hz), sine}$	380 000 A^2s
$(di/dt)_{cr}$	$T_{VJ} = T_{VJM};$ $f = 50 \text{ Hz}; t_p = 200 \mu\text{s}$ $V_D = 2/3 V_{DRM}$	repetitive, $I_T = 860 \text{ A}$	100 $\text{A}/\mu\text{s}$
		$I_G = 1 \text{ A};$ $di_G/dt = 1 \text{ A}/\mu\text{s}$	non repetitive, $I_T = 290 \text{ A}$
$(dv/dt)_{cr}$	$T_{VJ} = T_{VJM};$ $R_{GK} = \infty; \text{method 1 (linear voltage rise)}$	$V_{DR} = 2/3 V_{DRM}$	1000 $\text{V}/\mu\text{s}$
P_{GM}	$T_{VJ} = T_{VJM};$ $I_T = I_{TAVM};$	$t_p = 30 \mu\text{s}$	120 W
		$t_p = 500 \mu\text{s}$	60 W
P_{GAV}			20 W
V_{RGM}			10 V
T_{VJ}			-40...+140 $^\circ\text{C}$
T_{VJM}			140 $^\circ\text{C}$
T_{stg}			-40...+125 $^\circ\text{C}$
V_{ISOL}	50/60 Hz, RMS; $I_{ISOL} \leq 1 \text{ mA};$	$t = 1 \text{ min}$	3000 V~
		$t = 1 \text{ s}$	3600 V~
M_d	Mounting torque (M5) Terminal connection torque (M8)		2.5-5/22-44 $\text{Nm}/\text{lb.in.}$
			12-15/106-132 $\text{Nm}/\text{lb.in.}$
Weight	Typical including screws		320 g

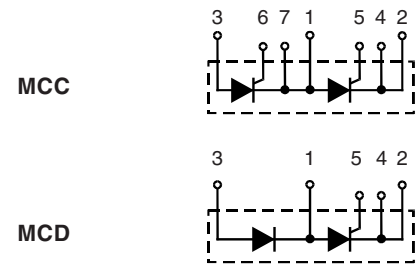

Features

- International standard package
- Direct copper bonded Al_2O_3 -ceramic base plate
- Planar passivated chips
- Isolation voltage 3600 V~
- UL registered, E 72873
- Keyed gate/cathode twin pins

Applications

- Motor control
- Power converter
- Heat and temperature control for industrial furnaces and chemical processes
- Lighting control
- Contactless switches

Advantages

- Space and weight savings
- Simple mounting
- Improved temperature and power cycling
- Reduced protection circuits

Data according to IEC 60747 and refer to a single thyristor/diode unless otherwise stated. IXYS reserves the right to change limits, test conditions and dimensions

Symbol	Conditions	Characteristic Values	
I_{RRM}	$T_{VJ} = T_{VJM}; V_R = V_{RRM}; V_D = V_{DRM}$	70	mA
I_{DRM}		40	mA
V_T, V_F	$I_T/I_F = 600 \text{ A}; T_{VJ} = 25^\circ\text{C}$	1.36	V
V_{T0}	For power-loss calculations only ($T_{VJ} = 140^\circ\text{C}$)	0.85	V
r_T		0.82	m Ω
V_{GT}	$V_D = 6 \text{ V}; T_{VJ} = 25^\circ\text{C}$	2	V
	$T_{VJ} = -40^\circ\text{C}$	3	V
I_{GT}	$V_D = 6 \text{ V}; T_{VJ} = 25^\circ\text{C}$	150	mA
	$T_{VJ} = -40^\circ\text{C}$	200	mA
V_{GD}	$T_{VJ} = T_{VJM}; V_D = \frac{2}{3} V_{DRM}$	0.25	V
I_{GD}		10	mA
I_L	$T_{VJ} = 25^\circ\text{C}; t_p = 30 \mu\text{s}; V_D = 6 \text{ V}$ $I_G = 0.45 \text{ A}; di_G/dt = 0.45 \text{ A}/\mu\text{s}$	200	mA
I_H	$T_{VJ} = 25^\circ\text{C}; V_D = 6 \text{ V}; R_{GK} = \infty$	150	mA
t_{gd}	$T_{VJ} = 25^\circ\text{C}; V_D = \frac{1}{2} V_{DRM}$ $I_G = 1 \text{ A}; di_G/dt = 1 \text{ A}/\mu\text{s}$	2	μs
t_q	$T_{VJ} = T_{VJM}; I_T = 300 \text{ A}, t_p = 200 \mu\text{s}; -di/dt = 10 \text{ A}/\mu\text{s}$ $V_R = 100 \text{ V}; dv/dt = 50 \text{ V}/\mu\text{s}; V_D = \frac{2}{3} V_{DRM}$	typ. 200	μs
Q_S	$T_{VJ} = 125^\circ\text{C}; I_T/I_F = 400 \text{ A}, -di/dt = 50 \text{ A}/\mu\text{s}$	760	μC
I_{RM}		275	A
R_{thJC}	per thyristor/diode; DC current per module	0.129	K/W
R_{thJK}	per thyristor/diode; DC current per module	0.169	K/W
	other values see Fig. 8/9	0.0645	K/W
		0.0845	K/W
d_S	Creepage distance on surface	12.7	mm
d_A	Strike distance through air	9.6	mm
a	Maximum allowable acceleration	50	m/s ²

Optional accessories for modules

Keyed gate/cathode twin plugs with wire length = 350 mm, gate = yellow, cathode = red
 Type **ZY 180L** (L = Left for pin pair 4/5) } UL 758, style 1385,
 Type **ZY 180R** (R = right for pin pair 6/7) } CSA class 5851, guide 460-1-1

Dimensions in mm (1 mm = 0.0394")

MCC

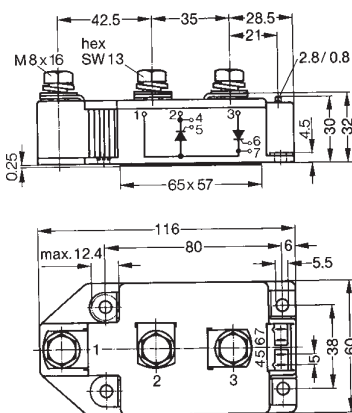

MCD

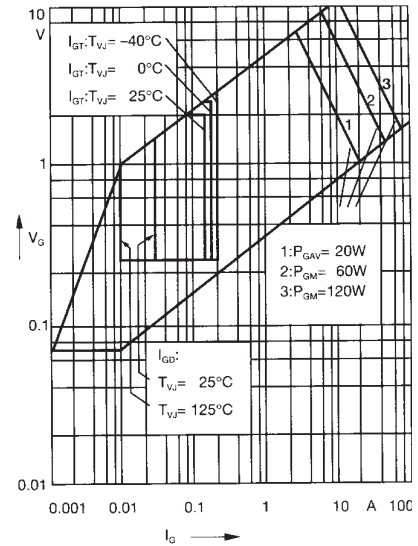
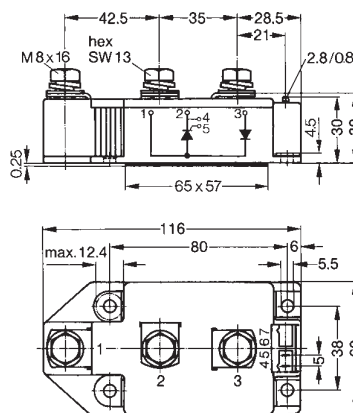

Fig. 1 Gate trigger characteristics

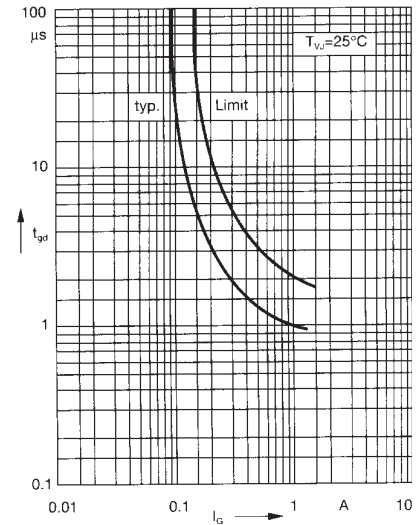
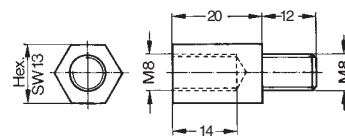

Fig. 2 Gate trigger delay time

Threaded spacer for higher Anode/Cathode construction:
 Type **ZY 250**, material brass



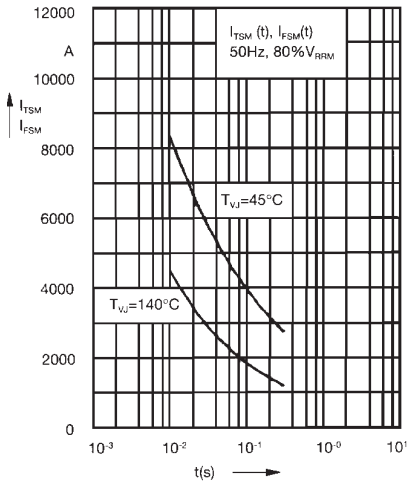

Fig. 3 Surge overload current
 I_{TSM} , I_{FSM} : Crest value, t : duration

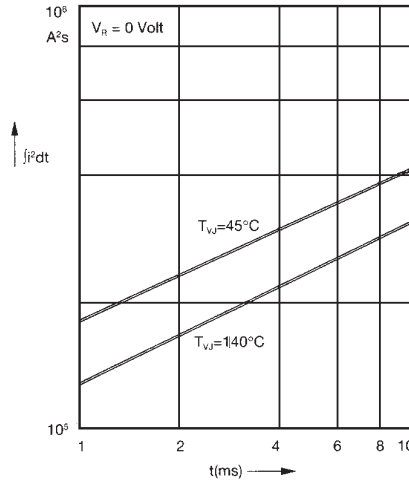

Fig. 4 j^2dt versus time (1-10 ms)

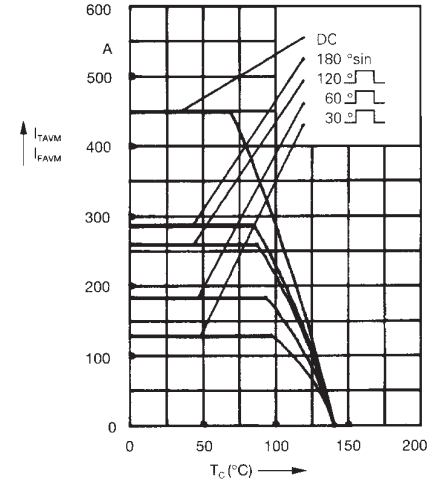

Fig. 4a Maximum forward current at case temperature

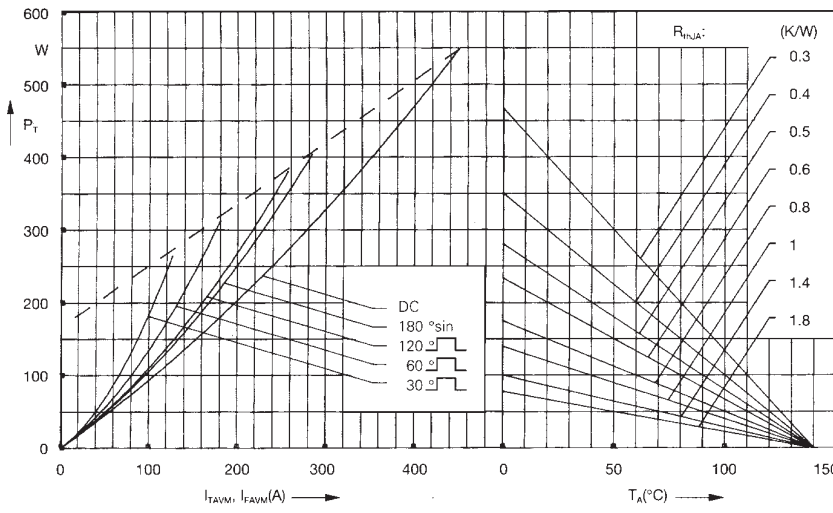

Fig. 5 Power dissipation versus on-state current and ambient temperature (per thyristor or diode)

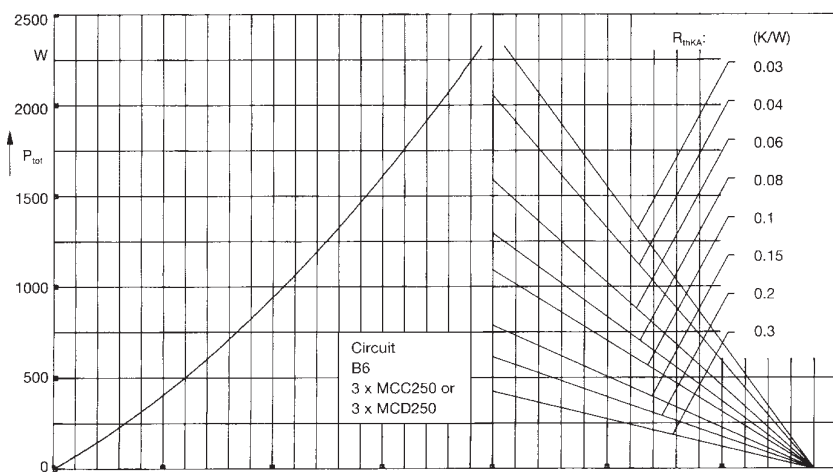

Fig. 6 Three phase rectifier bridge: Power dissipation versus direct output current and ambient temperature

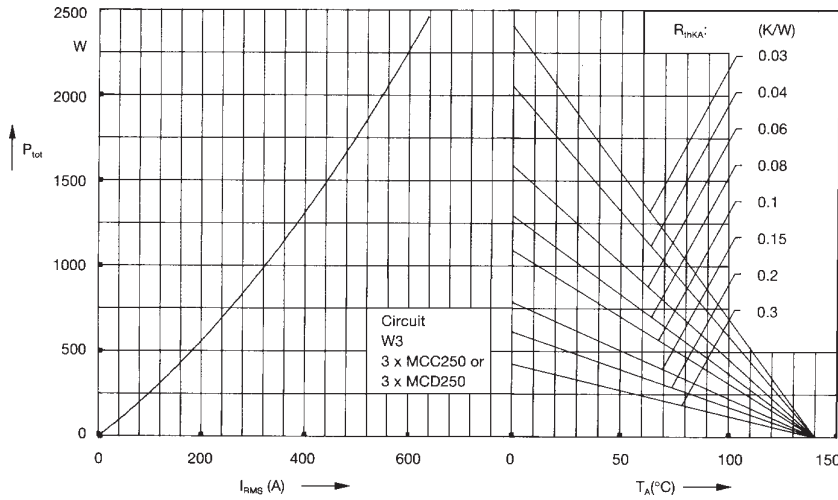

Fig. 7 Three phase AC-controller:
Power dissipation versus RMS
output current and ambient
temperature

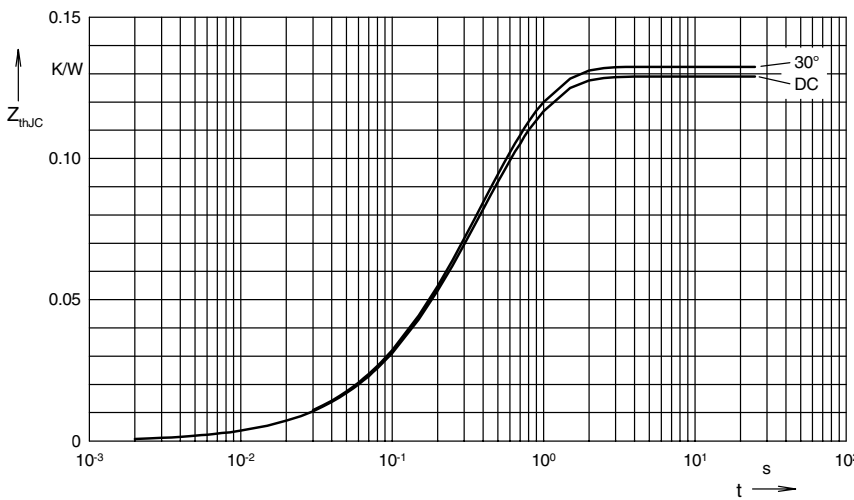

Fig. 8 Transient thermal impedance
junction to case (per thyristor or
diode)

R_{thJC} for various conduction angles d :

d	R_{thJC} (K/W)
DC	0.129
180°C	0.131
120°C	0.131
60°C	0.132
30°C	0.132

Constants for Z_{thJC} calculation:

i	R_{thi} (K/W)	t_i (s)
1	0.0035	0.099
2	0.0165	0.168
3	0.1091	0.456

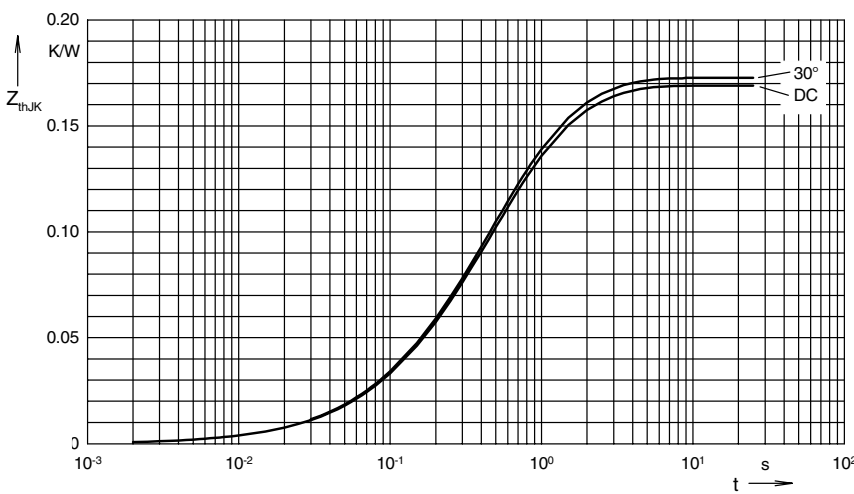

Fig. 9 Transient thermal impedance
junction to heatsink (per thyristor
or diode)

R_{thJK} for various conduction angles d :

d	R_{thJK} (K/W)
DC	0.169
180°C	0.171
120°C	0.172
60°C	0.172
30°C	0.173

Constants for Z_{thJK} calculation:

i	R_{thi} (K/W)	t_i (s)
1	0.0033	0.099
2	0.0159	0.168
3	0.1053	0.456
4	0.04	1.36