

Surface Mount Miniature Trimmers Single-Turn Cermet Sealed

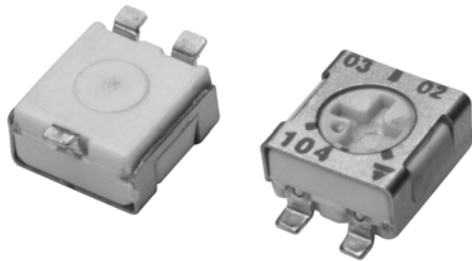

The TS53 trimming potentiometer has been designed for surface mount applications and offers volumetric efficiency (5 x 5 x 2.7 mm) with high performance and stability.

The TS53 design is suitable for both manual or automatic operation, and can withstand waves, and reflow soldering techniques.

FEATURES

- 0.25 Watt at 70 °C
- For PCB version see T53Y series
- Excellent stability
- Wide ohmic range
- Low temperature coefficient
- Low contact resistance variation
- Small size for optimum packing density
- Suitable for both manual or automatic operation



DIMENSIONS in millimeters

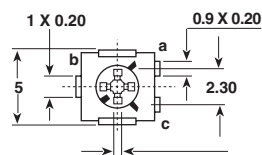
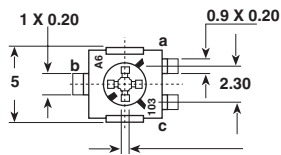
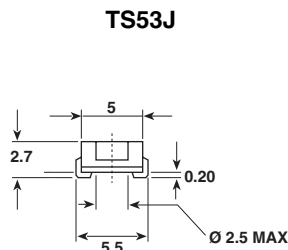
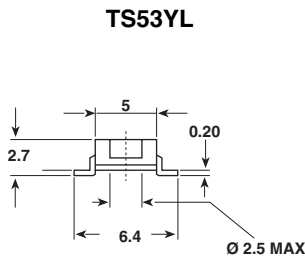

cruciform screwdriver slot
ø 2.5, width 0.5
deep: 0.55
max deep (center): 0.7

RECOMMENDED SOLDERING AREAS

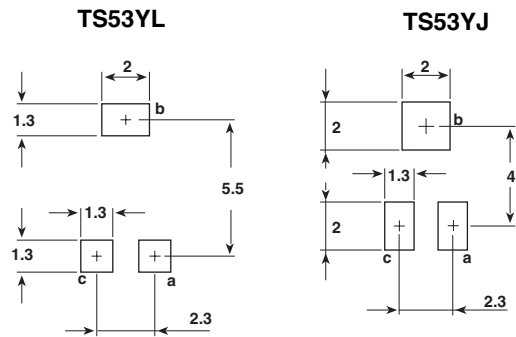

ADHESIVE PAD (detail)

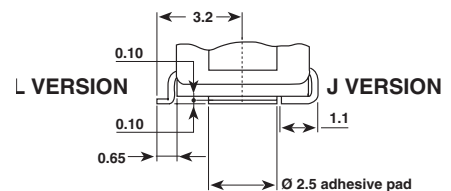

CIRCUIT DIAGRAM

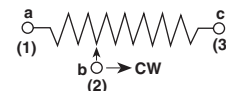

Tolerances unless otherwise specified ± 0.25 mm



ELECTRICAL SPECIFICATIONS		
Resistive Element		Cermet
Electrical Travel		220° ± 15°
Resistance Range		10 Ω to 1 MΩ
Standard Series		1 - 2 - 5
Tolerance Standard		± 20 %
Power Rating	Linear	0.25 W at 70 °C
	Logarithmic	not applicable
Temperature Coefficient		See Standard Resistance Element Data
Limiting Element Voltage (Linear Law)		200 V
Contact Resistance Variation		1 % or 3 Ω
End Resistance (Typical)		0.1 % or 3 Ω
Dielectric Strength (RMS)		1000 V
Insulation Resistance		10 ⁶ MΩ

MECHANICAL SPECIFICATIONS

Mechanical Travel	270° ± 10°
Operating Torque (max. Ncm)	1.5
End Stop Torque (max. Ncm)	3.5
Unit Weight (max. g)	0.15

ENVIRONMENTAL SPECIFICATIONS

Temperature Range	- 55 °C to + 125 °C
Climatic Category	55 / 125 / 56
Sealing	sealed container

POWER RATING CHART

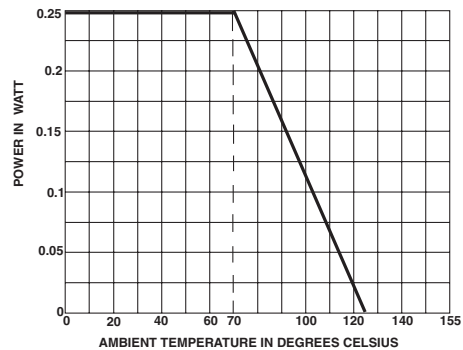

PERFORMANCE			
TESTS	CONDITIONS	TYPICAL VALUES AND DRIFTS	
		$\frac{\Delta RT}{RT}$ (%)	$\frac{\Delta R_{1-2}}{R_{1-2}}$ (%)
Load Life	1000 hours at rated power 90°/30' - ambient temperature + 70 °C	± 2 % Contact resistance variation: $\Delta R < 1 \% R_n$	± 3 %
Climatic Sequence	Phase A dry heat 125 °C Phase B damp heat Phase C cold - 55 °C Phase D damp heat 5 cycles	± 2 %	± 3 %
Long Term Damp Heat	Temperature 40 °C - RH 93 % 56 days	± 2 % Dielectric strength: 1000 V RMS Insulation resistance: > 10 ⁴ MΩ	± 3 %
Thermal Shock	55 °C to + 125 °C - 5 cycles	± 1 %	$\frac{\Delta V_{1-2}}{V_{1-3}} \leq \pm 2 \%$
Rotational Life (Electrical and Mechanical)	100 cycles - rated power	± 3 %	
Shock	50 g - 11 ms 3 successive shocks in 3 directions	± 1 %	$\frac{\Delta V_{1-2}}{V_{1-3}} \leq \pm 1 \%$
Vibration	10 - 55 Hz 0.75 mm or 10 g - 6 hours	± 1 %	$\frac{\Delta V_{1-2}}{V_{1-3}} \leq \pm 1 \%$

STANDARD RESISTANCE ELEMENT DATA				
STANDARD RESISTANCE VALUES	LINEAR LAW			T.C. - 55 °C + 125 °C ppm/°C
	MAX. POWER AT 70 °C	MAX. WORKING VOLTAGE	MAX. CUR. THROUGH ELEMENT	
Ω	W	V	mA	
10	0.25	1.58	158	0 + 200
20		2.24	112	
50		3.54	71	
100	↓	5	50	± 100
200		7.07	35	
500		11.2	22	
1k		15.8	16	
2k		22.4	11	
5k		35.4	7	
10k		50	5	
20k		70.7	3.5	
50k		112	2.2	
100k		0.25	158	
200k	0.20	200	1.0	
500k	0.08	200	0.4	
1M	0.04	200	0.2	

MARKING

VISHAY trademark, ohmic value, manufacturing date.

The ohmic value is indicated by a 3 figure code, the first two are significant figures, the third one is the multiplier.

Example:
 100 = 10 Ω
 101 = 100 Ω
 102 = 1000 Ω
 503 = 50000 Ω

SOLDERING RECOMMENDATIONS

See application notes

PACKAGING

On tape and reel of 500 pieces, code TR and 2000 pieces, code TR1

3 slots - width 2 to 120° - ø ext. 23

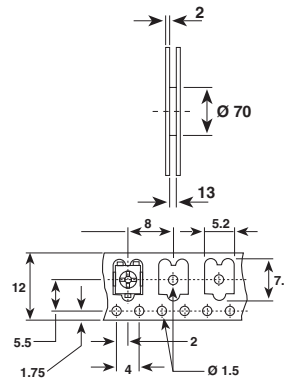
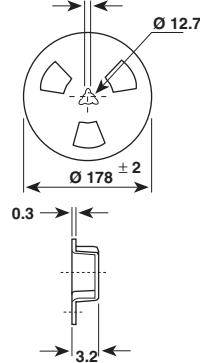

Cover tape panel strength specifications EIA 481 A and CEI 60286-3.

ORDERING INFORMATION

TS53 SERIES	YL STYLE	500 KΩ OHMIC VALUE	± 20 % TOLERANCE	TR500 PACKAGING	e3 LEAD FINISH
----------------	-------------	-----------------------	---------------------	--------------------	-------------------

TR: Tape and reel 500 pcs.
 on request: TR1: Tape and reel 2000 pcs. e3: pure Sn

SAP PART NUMBERING GUIDELINES

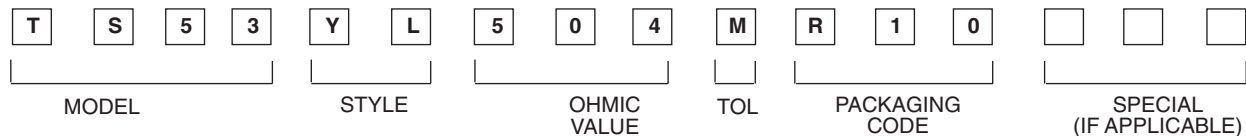

See the end of this data book for conversion tables



Notice

Specifications of the products displayed herein are subject to change without notice. Vishay Intertechnology, Inc., or anyone on its behalf, assumes no responsibility or liability for any errors or inaccuracies.

Information contained herein is intended to provide a product description only. No license, express or implied, by estoppel or otherwise, to any intellectual property rights is granted by this document. Except as provided in Vishay's terms and conditions of sale for such products, Vishay assumes no liability whatsoever, and disclaims any express or implied warranty, relating to sale and/or use of Vishay products including liability or warranties relating to fitness for a particular purpose, merchantability, or infringement of any patent, copyright, or other intellectual property right.

The products shown herein are not designed for use in medical, life-saving, or life-sustaining applications. Customers using or selling these products for use in such applications do so at their own risk and agree to fully indemnify Vishay for any damages resulting from such improper use or sale.