



OPTICALLY COUPLED BILATERAL SWITCH LIGHT ACTIVATED ZERO VOLTAGE CROSSING TRIAC

DESCRIPTION

The MOC308_ Series are optically coupled isolators consisting of a Gallium Arsenide infrared emitting diode coupled with a monolithic silicon detector performing the functions of a zero crossing bilateral triac mounted in a standard 6 pin dual-in-line package.

FEATURES

- Options :-
10mm lead spread - add G after part no.
Surface mount - add SM after part no.
Tape&reel - add SMT&R after part no.
- High Isolation Voltage, 5.3kV_{RMS}
- Zero Voltage Crossing
- 800V Peak Blocking Voltage
- All electrical parameters 100% tested
- Custom electrical selections available

APPLICATIONS

- CRTs
- Power Triac Driver
- Motors
- Consumer appliances
- Printers

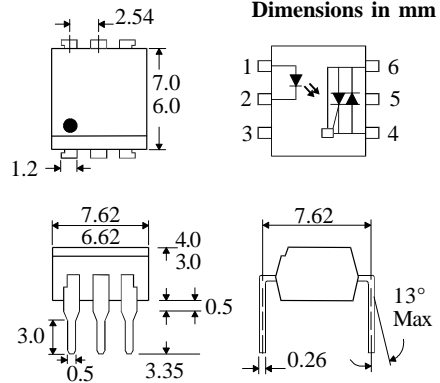

ABSOLUTE MAXIMUM RATINGS (25 °C unless otherwise noted)

Storage Temperature _____ -55°C - +150°C
 Operating Temperature _____ -40°C - +100°C
 Lead Soldering Temperature _____ 260°C
 (1.6mm from case for 10 seconds)

INPUT DIODE

Forward Current _____ 50mA
 Reverse Voltage _____ 6V
 Power Dissipation _____ 120mW
 (derate linearly 1.41mW/°C above 25°C)

OUTPUT PHOTO TRIAC

Off-State Output Terminal Voltage _____ 800V
 Forward Current (Peak) _____ 1A
 Power Dissipation _____ 150mW
 (derate linearly 1.76mW/°C above 25°C)

POWER DISSIPATION

Total Power Dissipation _____ 250mW
 (derate linearly 2.94mW/°C above 25°C)

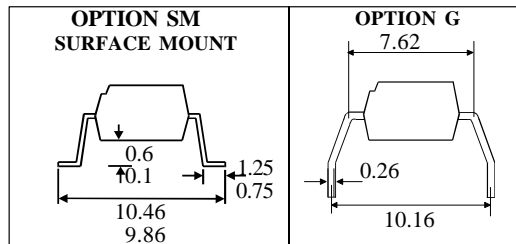

ISOCOM COMPONENTS LTD
 Unit 25B, Park View Road West,
 Park View Industrial Estate, Brenda Road
 Hartlepool, TS25 1YD England Tel: (01429)863609
 Fax : (01429) 863581 e-mail sales@isocom.co.uk
<http://www.isocom.com>

ISOCOM INC
 1024 S. Greenville Ave, Suite 240,
 Allen, TX 75002 USA
 Tel: (214) 495-0755 Fax: (214) 495-0901
 e-mail info@isocom.com
<http://www.isocom.com>

ELECTRICAL CHARACTERISTICS ($T_A = 25^\circ\text{C}$ Unless otherwise noted)

PARAMETER		MIN	TYP	MAX	UNITS	TEST CONDITION
Input	Forward Voltage (V_F) Reverse Current (I_R)		1.2	1.4 10	V μA	$I_F = 20\text{mA}$ $V_R = 6\text{V}$
Output	Peak Off-state Current (I_{DRM}) Peak Blocking Voltage (V_{DRM}) On-state Voltage (V_{TM}) Critical rate of rise of off-state Voltage (dv/dt)	800		500 3.0	nA V V $\text{V}/\mu\text{s}$	$V_{\text{DRM}} = 800\text{V}$ (note 1) $I_{\text{DRM}} = 500\text{nA}$ $I_{\text{TM}} = 100\text{mA}$ (peak)
Coupled	Input Current to Trigger (I_{FT})(note 2) MOC3080 MOC3081 MOC3082 MOC3083 Holding Current , either direction (I_H) Input to Output Isolation Voltage V_{ISO}			30 15 10 5	mA mA mA mA μA V_{RMS}	$V_{\text{TM}} = 3\text{V}$ (note 2) See note 3
Zero Crossing Charact- -eristic	Inhibit Voltage (V_{IH}) Leakage in Inhibited State (I_S)			20 500	V μA	$I_F = \text{Rated } I_{\text{FT}}$ MT1-MT2 Voltage above which device will not trigger $I_F = \text{Rated } I_{\text{FT}}$ $V_{\text{DRM}} = 600\text{V}$ off-state

Note 1. Guaranteed to trigger at an I_F value less than or equal to max. I_{FT} , recommended I_F lies between Rated I_{FT} and absolute max. I_F .

Note 2. Measured with input leads shorted together and output leads shorted together.

CHARACTERISTIC CURVES

Fig.1 Forward Current vs. Ambient Temperature

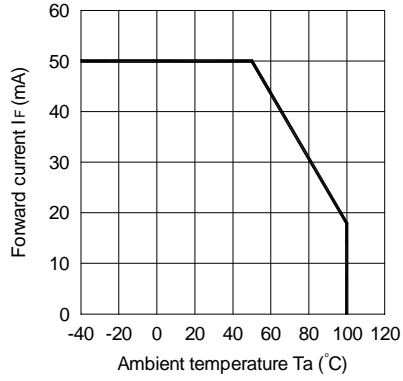

Fig.2 On-state Current vs. Ambient Temperature

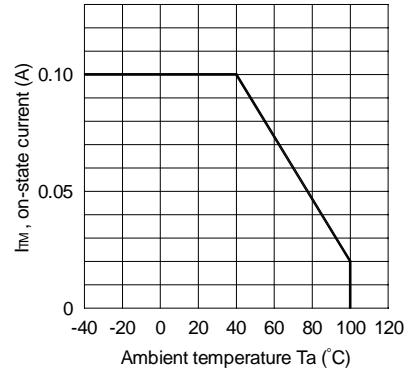

Fig.3 Minimum Trigger Current vs. Ambient Temperature

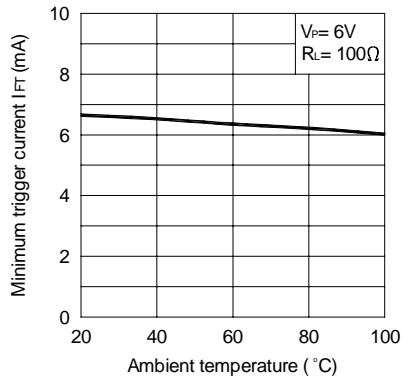

Fig.4 Forward Current vs. Forward Voltage

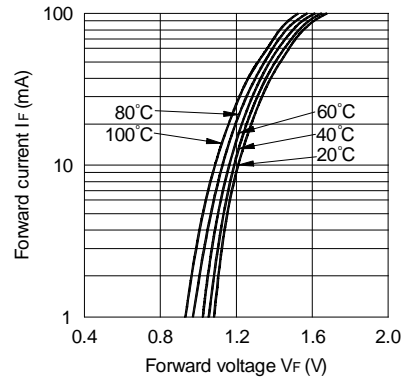

Fig.5 On-state Voltage vs. Ambient Temperature

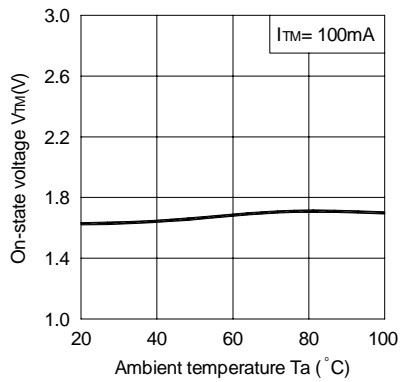
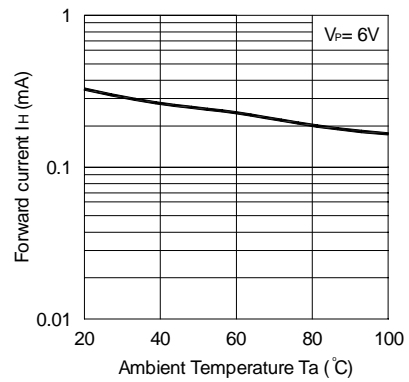

Fig.6 Holding Current vs. Ambient Temperature



CHARACTERISTIC CURVES

Fig.7 Turn-on Time vs. Forward Current

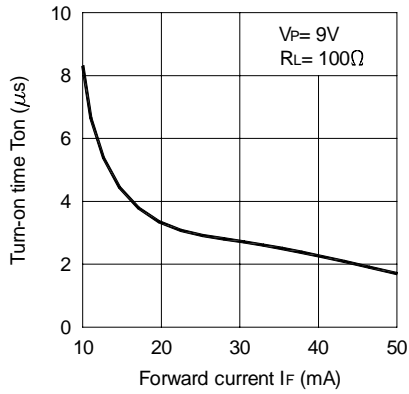

Fig.8 Repetitive Peak Off-state Current vs. Temperature

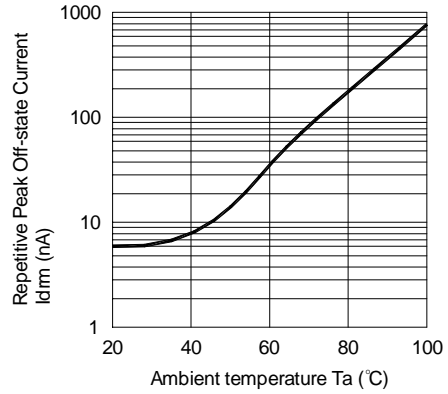
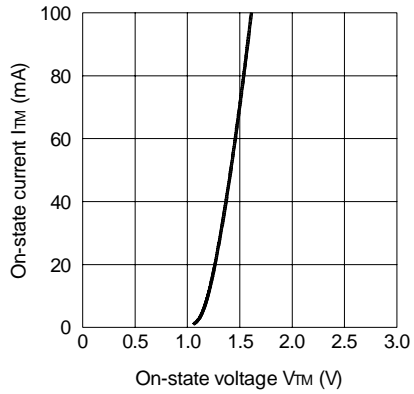

Fig.9 On-state Current vs. On-state Voltage



Static dv/dt Test Circuit

