



SAC-3P-M12MR/1,5-PUR/CI-1L-S

Order No.: 1669411



<http://eshop.phoenixcontact.de/phoenix/treeViewClick.do?UID=1669411>

Sensor/Actuator cable, 3-position, PUR/PVC, Black RAL 9005, Plug, angledLink:M12, A-coded, on CI valve connector (9.4 mm), with 1 LED, connected with Z diode, Cable length: 1.5 m

Commercial data		Product notes
GTIN (EAN)	 4 017918 134501	WEEE/RoHS-compliant since: 10/16/2006 
Note	Made-to-order	http://www.download.phoenixcontact.com Please note that the data given here has been taken from the online catalog. For comprehensive information and data, please refer to the user documentation. The General Terms and Conditions of Use apply to Internet downloads.
sales group	D115	
Pack	1 pcs.	
Customs tariff	85444290	
Catalog page information	Page 90 (PC-2007)	

Technical data	
General data	
Rated current at 40°C	4 A
Rated voltage	24 V 24 V (in acc. with DIN VDE 0110)
Number of positions	3

Volume resistance	≤ 5 mΩ
Insulation resistance	≥ 100 MΩ
Length of cable	1.5 m
Ambient temperature (operation)	-25 °C ... 90 °C (Male connector / female connector) -20 °C ... 80 °C (valve plug)

General characteristics

Coding	A - standard
Surge voltage category	II
Pollution degree	3
Degree of protection	IP67
Insertion/withdrawal cycles	≥ 100
Contact material	CuSn
Contact surface material	Ni/Au
Contact carrier material	TPU GF
Material of grip body	TPU, hardly inflammable, self-extinguishing
Contact material	CuSn
Contact surface material	Ag
Valve plug contact insert material	PBT
Material, housing, valve plug	PBT
Sealing material	TPU (Flat gasket valve plug)
Status display	1 LED
Protective circuit/component	Z diode

Conductor data

Cable type	PUR/PVC black
Cable abbreviation	LiYY11Y-JZ
Conductor cross section	0.75 mm ²
AWG signal line	18
Conductor structure signal line	42x 0.15 mm
Core diameter including insulation	Approx. 1.8 mm
Thickness, insulation	Approx. 0.34 mm (Core insulation) Approx. 0.35 mm (Outer cable sheath) Approx. 0.3 mm (Inner sheath)
External cable diameter	5.90 mm
Wire colors	Black 1, black 2, green/yellow

External sheath, color	Black RAL 9005
Insulation resistance	$\geq 1 \text{ M}\Omega \cdot \text{km}$
Nominal voltage, conductor	300 V
Test voltage, conductor	2000 V
Overall twist	3 concentrically twisted wires
Outer sheath, material	PUR
Material, inner sheath	PVC
Material conductor insulation	PVC
Conductor material	Bare Cu litz wires
Smallest bending radius, movable installation	59 mm
Ambient temperature (operation)	-30 °C ... 70 °C (cable, fixed installation) -5 °C ... 70 °C (cable, flexible installation)

Certificates / Approvals



Certification

GOST

Diagrams/Drawings

Dimensioned drawing

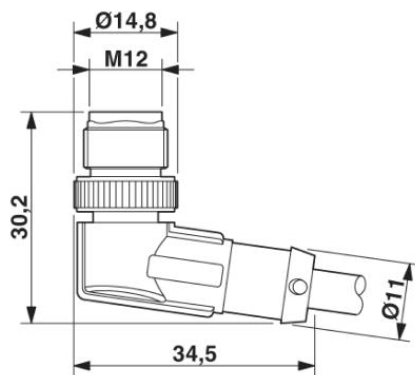

M12 x 1 male connector, angled

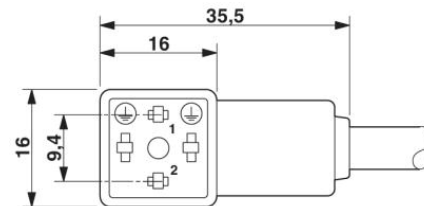

Valve connector, type CI

Circuit diagram

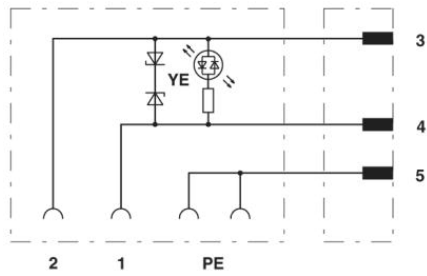

Contact assignment of M12 plug and valve connector

Schematic diagram

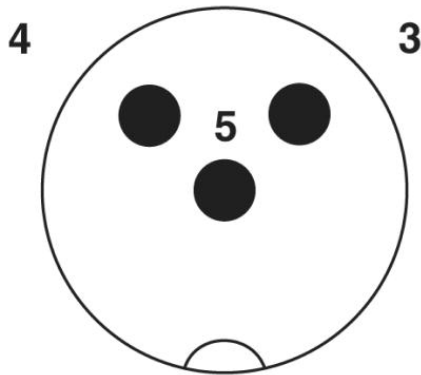

Pin assignment M12 plug, 3-pos., valve connector

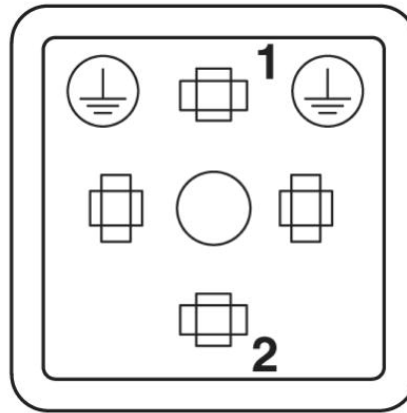

Valve connector connector pin assignment, type CI

Address

PHOENIX CONTACT Inc., USA
586 Fulling Mill Road
Middletown, PA 17057, USA
Phone (800) 888-7388
Fax (717) 944-1625
<http://www.phoenixcon.com>



© 2012 Phoenix Contact
Technical modifications reserved;