

NOTES

MATERIAL (ABS) FLAME RETARDANT UL94 V0 MATERIAL WITH BRASS INSERTS IN CORNER POSTS.
(STYRENE) IS NON-FLAME RETARDANT WITHOUT BRASS INSERTS.

PARTS (ABS) VERSION MACHINE SCREWS M3-0.5 x 18mm. REPLACEMENT PN 1594MS100 (100 / BAG). ABS VERSION MACHINE SCREWS FOR THE WATER RESISTANT BOX REPLACEMENT PN 1594WMS100 (STYRENE) VERSION SELF TAPPING #4 x 1.0". REPLACEMENT PN 1594TS100 (100 / BAG).

COLORS (ABS) BLACK, GRAY (STYRENE) GRAY ONLY.

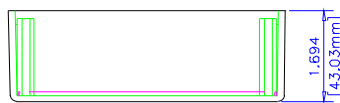
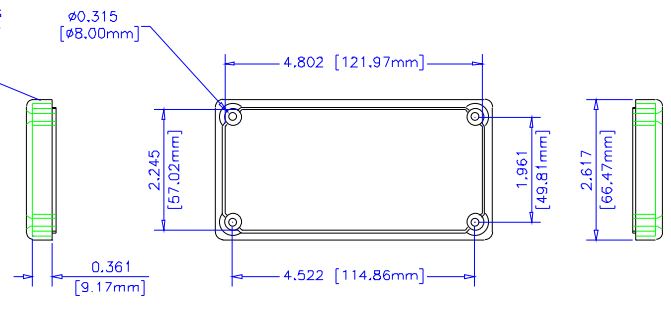
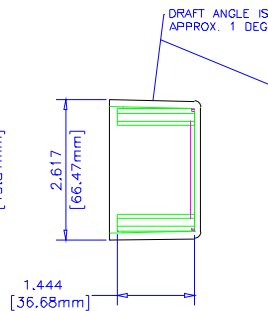
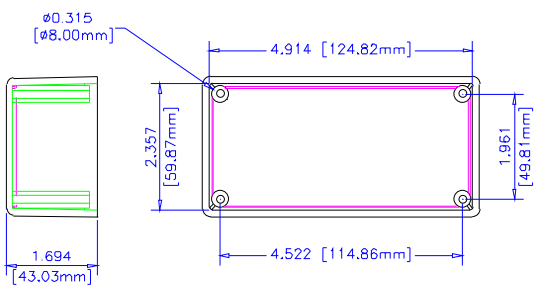
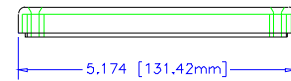
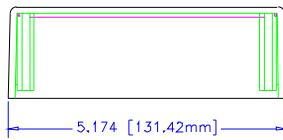

BOTTOM

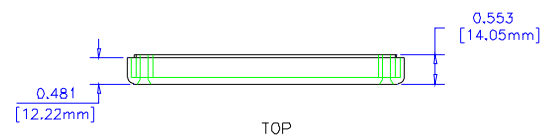

TOP

UNLESS OTHERWISE SPECIFIED
DIMENSIONS ARE IN INCHES
F. +/- .1
FF +/- .08
FKK +/- .015
DUP +/- .005
INCHES +/- .005
DEC.

PROPERTY RIGHTS NOTICE
THE MATERIAL OF THIS DRAWING IS TO
INTENDED TO BE USED AS A REFERENCE FOR
ENGINEERING PURPOSES ONLY. THIS
INFORMATION MAY NOT BE USED TO
REPRODUCE, REPRODUCE, REPRODUCE, REPRODUCE
WITHOUT THE WRITTEN PERMISSION OF HAMMOND MANUFACTURING.



**HAMMOND
MANUFACTURING**

WEB: WWW.HAMMONDMFG.COM

TITLE HAMMOND 1594 SERIES
PLASTIC ENCLOSURE

DRAWN BY MJM DATE 01/07/01
SCALE PAGE 1 OF 1

PART NUMBER 1594D