

LITEON**LTS-310A SERIES****0.3" SINGLE DIGIT NUMERIC DISPLAYS**

T-41-33

FEATURES

- 0.3 INCH (7.62mm) DIGIT HEIGHT.
- CHOICE OF SIX BRIGHT COLORS-RED/BRIGHT RED / GREEN / YELLOW / ORANGE / HIGH EFFICIENCY RED.
- LOW POWER REQUIREMENT.
- EXCELLENT CHARACTERS APPEARANCE.
- CATEGORIZED FOR LUMINOUS INTENSITY.
- I.C. COMPATIBLE.
- EASY MOUNTING ON P.C. BOARD OR SOCKETS.

DESCRIPTION

The LTS-310A series are 0.3 inch (7.62mm) height single digit displays.

The red series devices utilize LED chips which are made from GaAsP on a GaAs substrate. The bright red and green series devices utilize LED chips which are made from GaP on a transparent GaP substrate. The yellow, orange and high efficiency red series devices utilize LED chips which are made from GaAsP on a transparent GaP substrate. Red and bright red displays have black face and red segment color. Green and yellow displays have gray face and white segment color. Orange displays have orange face and orange segment color. High efficiency red displays have red face and red segment color.



SEVEN SEGMENT LED DISPLAYS
0.3" SINGLE DIGIT NUMERIC DISPLAYS

DEVICES

PART NO. LTS--						DESCRIPTION	PACKAGE DIMENSION	INTERNAL CIRCUIT DIAGRAM
RED	BRIGHT RED	GREEN	YELLOW	ORANGE	HI.-EFF. RED			
311AR	311AP	311AG	311AY	311AE	311AHR	Universal, ± 1 Overflow	B	A
312AR	312AP	312AG	312AY	312AE	312AHR	Common Anode, Rt. and Lt. Hand Decimal	A	B
313AR	313AP	313AG	313AY	313AE	313AHR	Common Cathode, Rt. Hand Decimal	A	C
315AR	315AP	315AG	315AY	315AE	315AHR	Common Cathode, Rt. Hand Decimal	A	D
316AR	316AP	316AG	316AY	316AE	316AHR	Common Anode, ± 1 Overflow	B	E

PACKAGE DIMENSIONS

A. LTS-312A/313A/315A

B. LTS-311A/316A

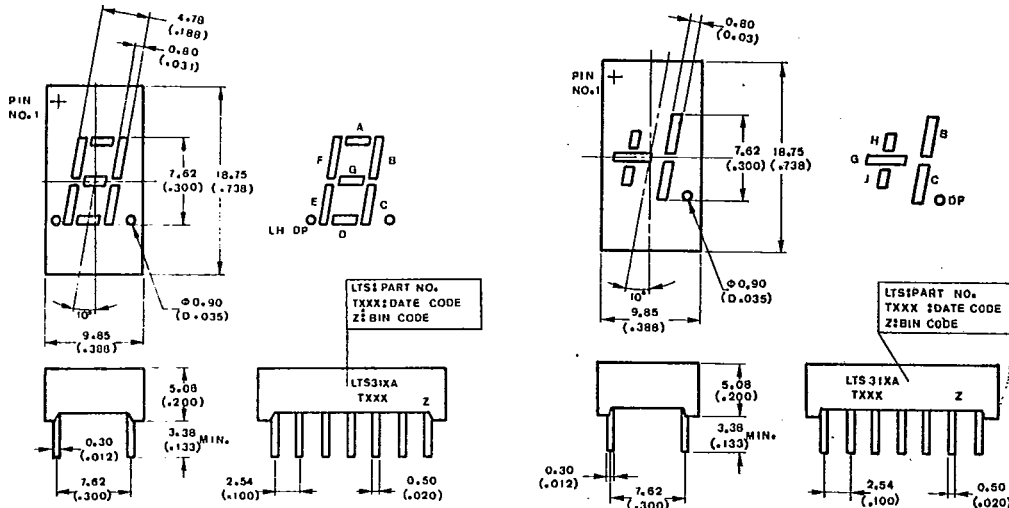

NOTE: All dimensions are in millimeters (inches) tolerance are:

1. Lead length (from seating plane): minimum value $\frac{+1.00}{-0.00}$ mm ($\frac{+0.040''}{-0.000''}$)

2. ± 0.25 mm (0.010'') unless otherwise noted.

PIN CONNECTION

PIN NO.	CONNECTION				
	A. LTS-311A	B. LTS-312A	C. LTS-313A	D. LTS-315A	E. LTS-316A
1	Anode H	Cathode A	Common Cathode *2	Anode F	Anode G,H&J *4
2	No Pin	Cathode F	Anode F	Anode G	No Pin
3	Cathode H	Common Anode *1	Anode G	No Pin	Anode G, H&J *4
4	Cathode G	No Pin	Anode E	Common Cathode *3	No Pin
5	Cathode J	No Pin	Anode D	No Pin	No Pin
6	Anode J	Cathode L,D,P.	Common Cathode *2	Anode E	No Pin
7	Anode G	Cathode E	Anode D.P.	Anode D	Cathode H&J
8	Anode D.P.	Cathode D	Anode C	Anode C	Cathode G
9	No Pin	Cathode R,D,P.	Anode B	Anode D.P.	No Connection
10	Cathode D.P.	Cathode C	Anode A	No Pin	Cathode C
11	Cathode C	Cathode G	-	No Pin	Cathode B
12	Cathode B	No Pin	-	Common Cathode *3	No Pin
13	Anode B	Cathode B	-	Anode B	No Pin
14	Anode C	Common Anode *1	-	Anode A	Anode B&C

NOTES: 1. Pin 3 & 14 are internally connected. 3. Pin 4 & 12 are internally connected.
 2. Pin 1 & 6 are internally connected. 4. Pin 1 & 3 are internally connected.

T-41-33

INTERNAL CIRCUIT DIAGRAM

A. LTS-311A

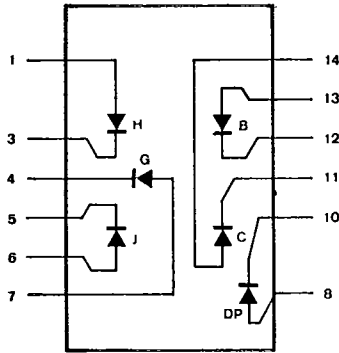

B. LTS-312A

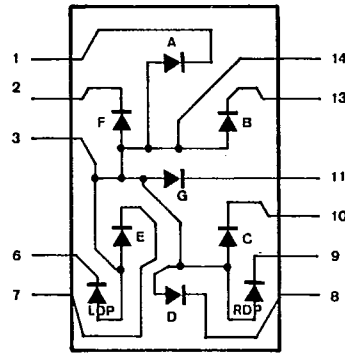

C. LTS-313A

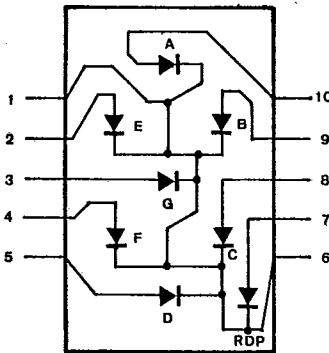

D. LTS-315A

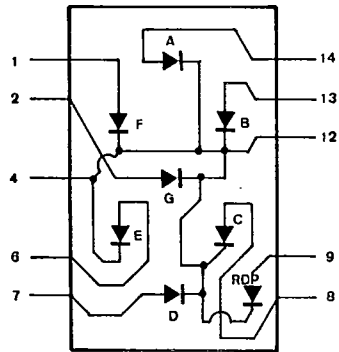

E. LTS-316A

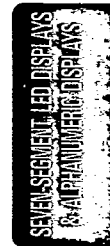
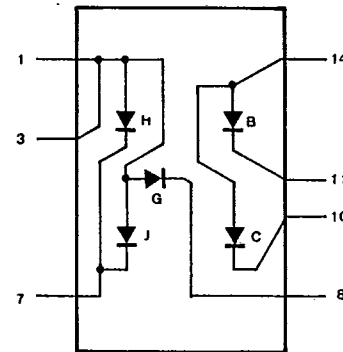

ABSOLUTE MAXIMUM RATINGS AT $T_A = 25^\circ\text{C}$

PARAMETER	RED	BRIGHT RED	GREEN	YELLOW	ORANGE	HI.-EFF. RED	UNIT
Power Dissipation Per Segment	55	40	75	60	75	75 ¹	mW
Peak Forward Current Per Segment (1/10 Duty Cycle, 0.1ms Pulse Width)	160	60	100	80	100	100	mA
Continuous Forward Current Per Segment	25	15	25	20	25	25	mA
Derating Linear From 25°C Per Segment	0.3	0.18	0.3	0.24	0.3	0.3	mA/°C
Reverse Voltage Per Segment	5	5	5	5	5	5	V
Operating Temperature Range	- 25°C to + 85°C						
Storage Temperature Range	- 25°C to + 85°C						
Solder Temperature 1/16 inch Below Seating Plane for 3 Seconds at 260°C							

**ELECTRICAL/OPTICAL CHARACTERISTICS AT TA = 25°C
LTS-310AR SERIES**

PARAMETER	SYMBOL	MIN.	TYP.	MAX.	UNIT	TEST CONDITION
Average Luminous Intensity	I_v	200	500		μcd	$I_F = 10 \text{ mA}$
Peak Emission Wavelength	λ_p		655		nm	$I_F = 20 \text{ mA}$
Spectral Line Half-Width	$\Delta\lambda$		24		nm	$I_F = 20 \text{ mA}$
Forward Voltage, any Segment or D.P.	V_F		1.7	2.0	V	$I_F = 20 \text{ mA}$
Reverse Current, any Segment or D.P.	I_R			100	μA	$V_R = 5\text{V}$
Luminous Intensity Matching Ratio	$I_v\text{-m}$			2:1		$I_F = 20 \text{ mA}$

TYPICAL ELECTRICAL/OPTICAL CHARACTERISTIC CURVES

(25°C Ambient Temperature Unless Otherwise Noted)

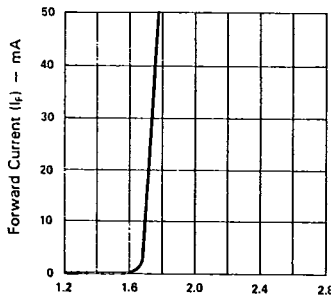

Fig. 1 FORWARD CURRENT Vs. FORWARD VOLTAGE.

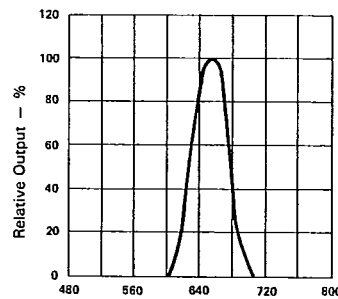

Fig. 2 SPECTRAL RESPONSE.

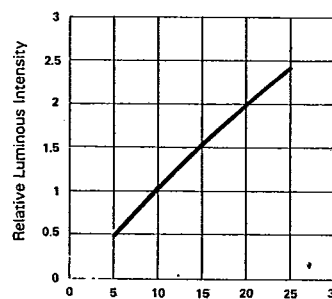

Fig. 3 RELATIVE LUMINOUS INTENSITY Vs. FORWARD CURRENT (PER SEGMENT).

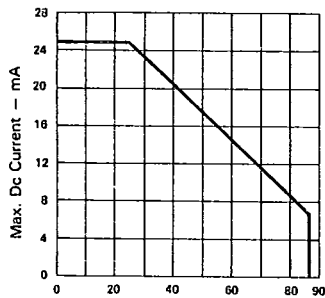

Fig. 4 MAX. ALLOWABLE DC CURRENT PER SEG. Vs AMBIENT TEMPERATURE.

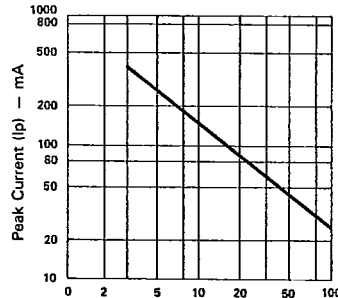

Fig. 5 MAX. PEAK CURRENT Vs. DUTY CYCLE.% (REFRESH RATE - F = 1. KHz)

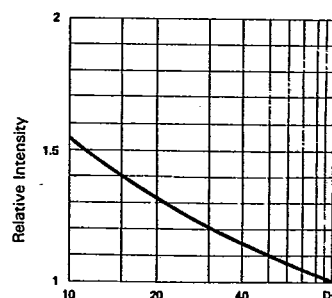

Fig. 6 LUMINOUS INTENSITY Vs. DUTY CYCLE.% (AVERAGE $I_F = 10\text{mA}$ PER SEG.)

ELECTRICAL/OPTICAL CHARACTERISTICS AT $T_A = 25^\circ\text{C}$
LTS-310AP SERIES

PARAMETER	SYMBOL	MIN.	TYP.	MAX.	UNIT	TEST CONDITION
Average Luminous Intensity	I_V	320	750		μcd	$I_F = 10 \text{ mA}$
Peak Emission Wavelength	λ_p		697		nm	$I_F = 20 \text{ mA}$
Spectral Line Half-Width	$\Delta\lambda$		90		nm	$I_F = 20 \text{ mA}$
Forward Voltage, any Segment or D.P.	V_F		2.1	2.8	V	$I_F = 20 \text{ mA}$
Reverse Current, any Segment or D.P.	I_R			100	μA	$V_R = 5\text{V}$
Luminous Intensity Matching Ratio	$I_V\text{-m}$			2:1		$I_F = 20 \text{ mA}$



TYPICAL ELECTRICAL/OPTICAL CHARACTERISTIC CURVES

(25°C Ambient Temperature Unless Otherwise Noted)

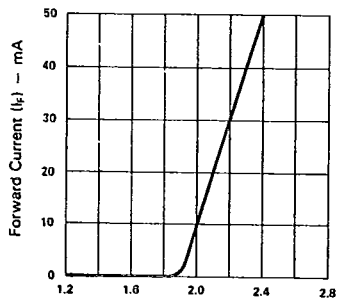

Fig. 1 FORWARD CURRENT vs. FORWARD VOLTAGE.

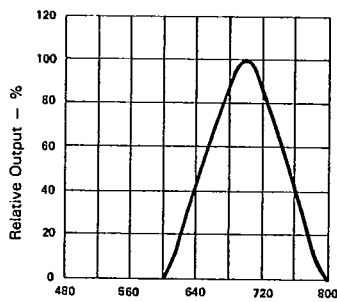

Fig. 2 SPECTRAL RESPONSE.

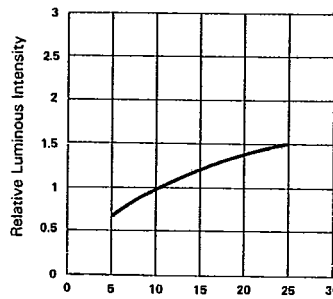

Fig. 3 RELATIVE, LUMINOUS INTENSITY vs. FORWARD CURRENT (PER SEGMENT).

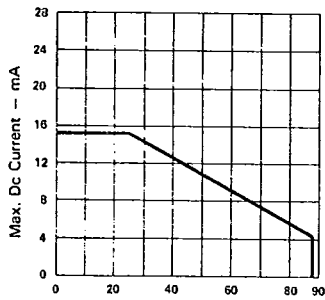

Fig. 4 MAX. ALLOWABLE DC CURRENT PER SEG. vs AMBIENT TEMPERATURE.

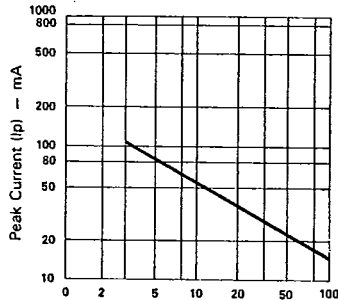

Fig. 5 MAX. PEAK CURRENT vs. DUTY CYCLE.% (REFRESH RATE - $F = 1 \text{ KHz}$)

**ELECTRICAL/OPTICAL CHARACTERISTICS AT TA = 25°C
LTS-310AG SERIES**

PARAMETER	SYMBOL	MIN.	TYP.	MAX.	UNIT	TEST CONDITION
Average Luminous Intensity	I_v	800	2000		μcd	$I_F = 10 \text{ mA}$
Peak Emission Wavelength	λ_p		565		nm	$I_F = 20 \text{ mA}$
Spectral Line Half-Width	$\Delta\lambda$		30		nm	$I_F = 20 \text{ mA}$
Forward Voltage, any Segment or D.P.	V_F		2.1	2.8	V	$I_F = 20 \text{ mA}$
Reverse Current, any Segment or D.P.	I_R			100	μA	$V_R = 5 \text{ V}$
Luminous Intensity Matching Ratio	$I_v\text{-m}$			2:1		$I_F = 20 \text{ mA}$

TYPICAL ELECTRICAL/OPTICAL CHARACTERISTIC CURVES

(25°C Ambient Temperature Unless Otherwise Noted)

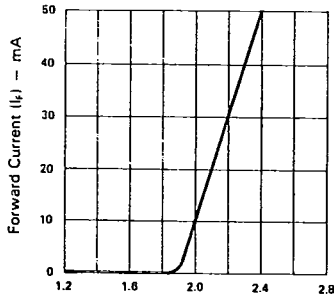

Fig. 1 FORWARD CURRENT Vs. FORWARD VOLTAGE.

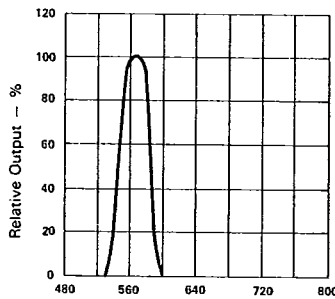

Fig. 2 SPECTRAL RESPONSE.

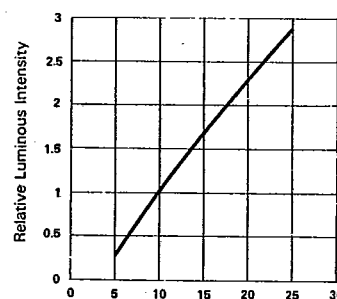

Fig. 3 RELATIVE LUMINOUS INTENSITY Vs. FORWARD CURRENT (PER SEGMENT).

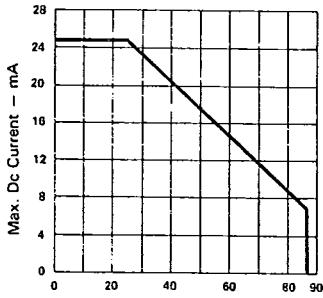

Fig. 4 MAX. ALLOWABLE DC CURRENT PER SEG. Vs AMBIENT TEMPERATURE.

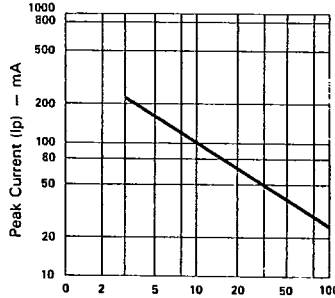

Fig. 5 MAX. PEAK CURRENT Vs. DUTY CYCLE.% (REFRESH RATE - F = 1 KHz)

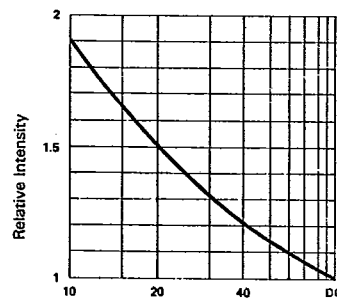

Fig. 6 LUMINOUS INTENSITY Vs. DUTY CYCLE% (AVERAGE $I_f = 10\text{mA}$ PER SEG.)

ELECTRICAL/OPTICAL CHARACTERISTICS AT TA = 25°C
LTS-310AY SERIES

PARAMETER	SYMBOL	MIN.	TYP.	MAX.	UNIT	TEST CONDITION
Average Luminous Intensity	I _v	800	2000		μcd	I _F = 10 mA
Peak Emission Wavelength	λ _p		585		nm	I _F = 20 mA
Spectral Line Half-Width	Δλ		35		nm	I _F = 20 mA
Forward Voltage, any Segment or D.P.	V _F		2.1	2.8	V	I _F = 20 mA
Reverse Current, any Segment or D.P.	I _R			100	μA	V _R = 5V
Luminous Intensity Matching Ratio	I _v -m			2:1		I _F = 20 mA



TYPICAL ELECTRICAL/OPTICAL CHARACTERISTIC CURVES

(25°C Ambient Temperature Unless Otherwise Noted)

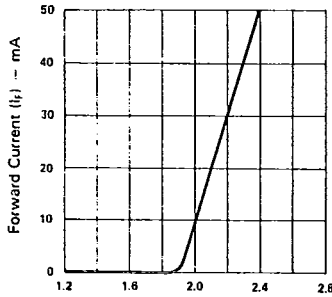

Fig. 1 FORWARD CURRENT Vs. FORWARD VOLTAGE.

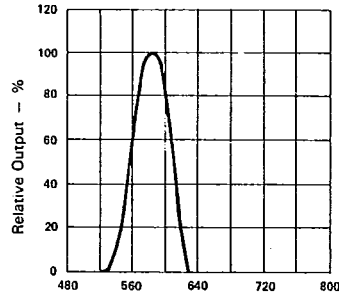

Fig. 2 SPECTRAL RESPONSE.

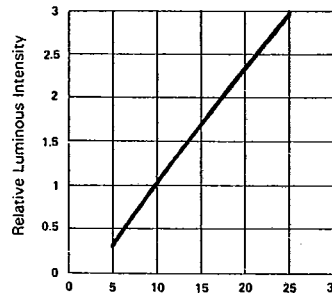

Fig. 3 RELATIVE LUMINOUS INTENSITY Vs. FORWARD CURRENT (PER SEGMENT).

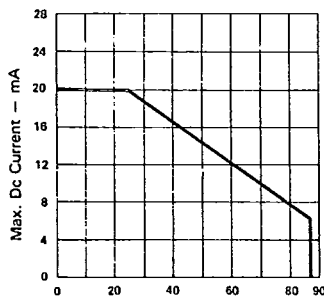

Fig. 4 MAX. ALLOWABLE DC CURRENT PER SEG. Vs AMBIENT TEMPERATURE.

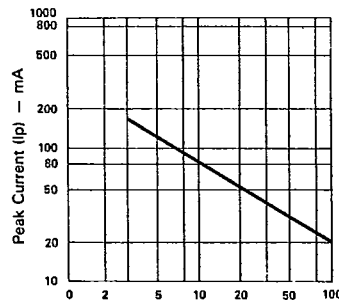

Fig. 5 MAX. PEAK CURRENT Vs. DUTY CYCLE % (REFRESH RATE - F = 1 KHz)

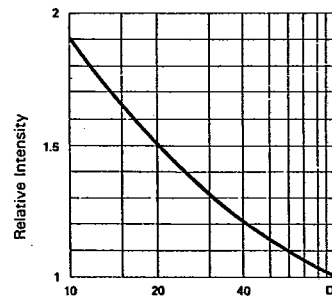

Fig. 6 LUMINOUS INTENSITY Vs. DUTY CYCLE% (AVERAGE I_F = 10mA PER SEG.)

ELECTRICAL/OPTICAL CHARACTERISTICS AT $T_A = 25^\circ\text{C}$
LTS-310AE SERIES

PARAMETER	SYMBOL	MIN.	TYP.	MAX.	UNIT	TEST CONDITION
Average Luminous Intensity	I_v	800	2000		μcd	$I_F = 10\text{ mA}$
Peak Emission Wavelength	λ_p		630		nm	$I_F = 20\text{ mA}$
Spectral Line Half-Width	$\Delta\lambda$		40		nm	$I_F = 20\text{ mA}$
Forward Voltage, any Segment or D.P.	V_F		2.1	2.8	V	$I_F = 20\text{ mA}$
Reverse Current, any Segment or D.P.	I_R			100	μA	$V_R = 5\text{V}$
Luminous Intensity Matching Ratio	$I_v\text{-m}$			2:1		$I_F = 20\text{ mA}$

TYPICAL ELECTRICAL/OPTICAL CHARACTERISTIC CURVES

(25°C Ambient Temperature Unless Otherwise Noted)

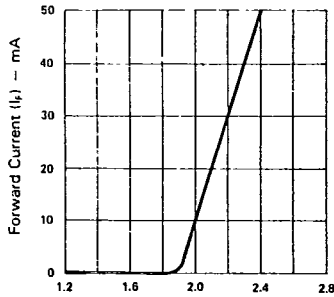

Fig. 1 FORWARD CURRENT Vs. FORWARD VOLTAGE.

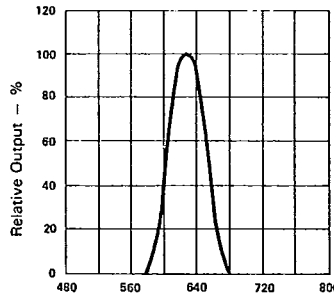

Fig. 2 SPECTRAL RESPONSE.

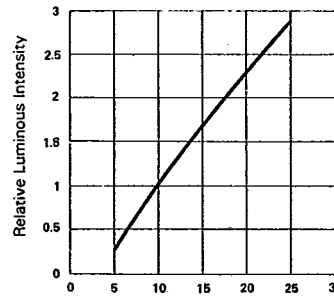

Fig. 3 RELATIVE LUMINOUS INTENSITY Vs. FORWARD CURRENT (PER SEGMENT).

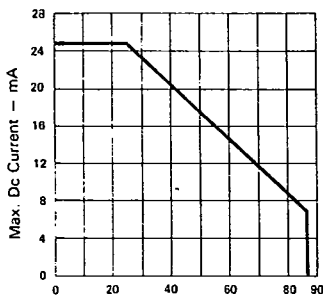

Fig. 4 MAX. ALLOWABLE DC CURRENT PER SEG. Vs AMBIENT TEMPERATURE.

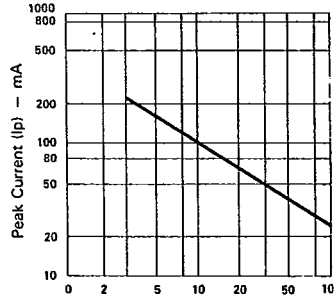

Fig. 5 MAX. PEAK CURRENT Vs. DUTY CYCLE.% (REFRESH RATE - F = 1 KHz)

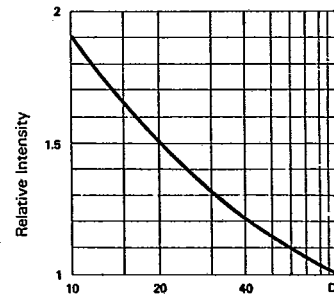

Fig. 6 LUMINOUS INTENSITY Vs. DUTY CYCLE% (AVERAGE $I_F = 10\text{mA}$ PER SEG.)

ELECTRICAL/OPTICAL CHARACTERISTICS AT $T_A = 25^\circ\text{C}$
LTS-310AHR SERIES

PARAMETER	SYMBOL	MIN.	TYP.	MAX.	UNIT	TEST CONDITION
Average Luminous Intensity	I_V	800	2000		μcd	$I_F = 10\text{ mA}$
Peak Emission Wavelength	λ_p		635		nm	$I_F = 20\text{ mA}$
Spectral Line Half-Width	$\Delta\lambda$		40		nm	$I_F = 20\text{ mA}$
Forward Voltage, any Segment or D.P.	V_F		2.1	2.8	V	$I_F = 20\text{ mA}$
Reverse Current, any Segment or D.P.	I_R			100	μA	$V_R = 5\text{ V}$
Luminous Intensity Matching Ratio	$I_V\text{-m}$			2:1		$I_F = 20\text{ mA}$

SEVEN SEGMENT LED DISPLAYS
& ALPHANUMERIC DISPLAYS

TYPICAL ELECTRICAL/OPTICAL CHARACTERISTIC CURVES

(25°C Ambient Temperature Unless Otherwise Noted)

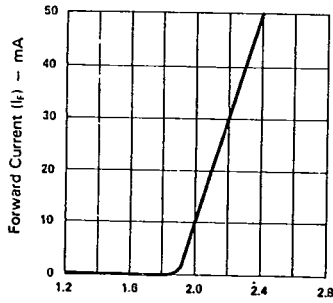

Fig. 1 FORWARD CURRENT Vs. FORWARD VOLTAGE.

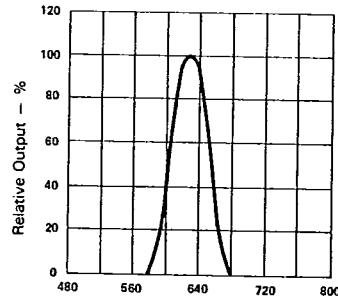

Fig. 2 SPECTRAL RESPONSE.

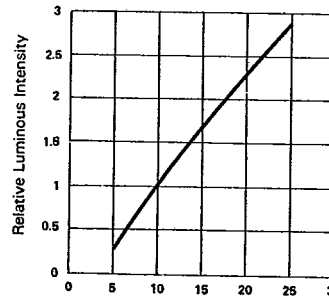

Fig. 3 RELATIVE, LUMINOUS INTENSITY Vs. FORWARD CURRENT (PER SEGMENT).

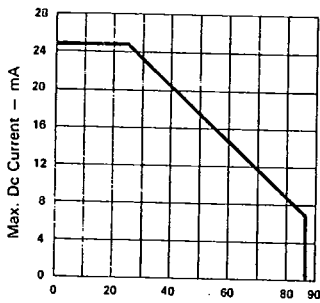

Fig. 4 MAX. ALLOWABLE DC CURRENT PER SEG. Vs AMBIENT TEMPERATURE.

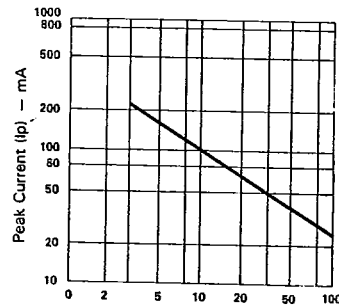

Fig. 5 MAX. PEAK CURRENT Vs. DUTY CYCLE.% (REFRESH RATE - $F = 1\text{ KHz}$)

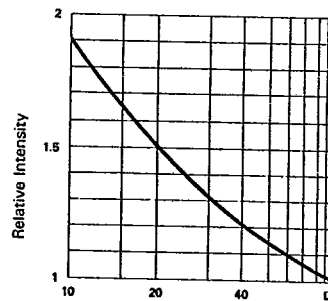

Fig. 6 LUMINOUS INTENSITY Vs. DUTY CYCLE% (AVERAGE $I_F = 10\text{ mA}$ PER SEG.)

PACKAGING

T-90-20

Reel Packaging (Axial Lead Units)

DEVICE TYPE	COMPONENT SPACE (MM) "A"	TAPE SPACE (MM) "B"	REEL DIA (MM) "D"	QUANTITY (EA)		CARTON	
				REEL	CARTON	SIZE (MM)	WEIGHT (KG)
DO-41 DO-41L	5±0.5	52.4±1.5	326~336	5000	20K	355 x 355 x 355	10.5
DO-201AD	10±0.5	52.4±1.5	326~336	1200	4.8K	355 x 355 x 355	9.0
P6(Aleg)	10±0.5	52.4±1.5	326~336	700	2.8K	355 x 355 x 355	8.8

The C dimension of Fig. 3 is between 3.17mm and 635mm greater than the length of the component involved.

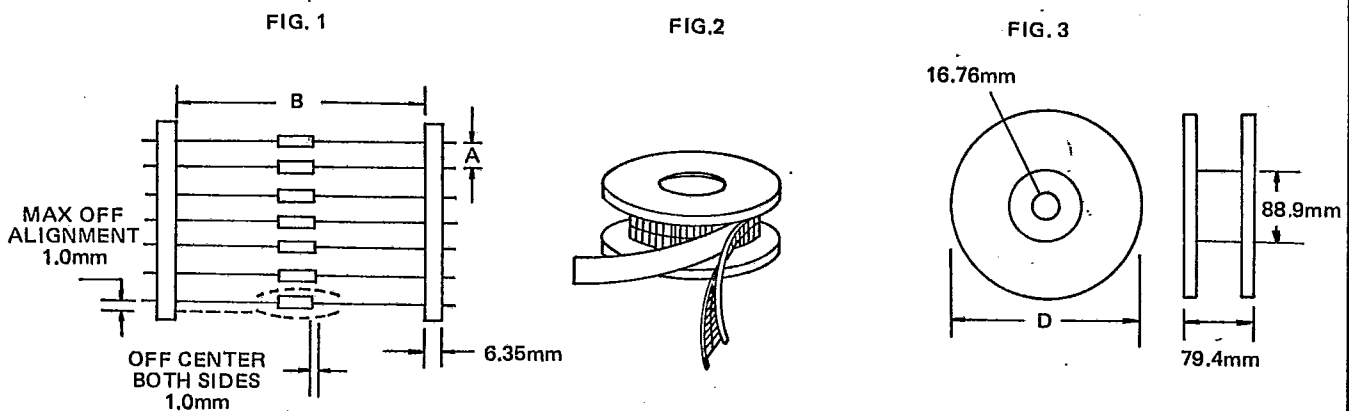

Bulk Packaging (Axial Lead Devices and Bridge Rectifiers)

DEVICE TYPE	PACKAGING SIZE (MM)		QUANTITY (EA)		APPROX GROSS WEIGHT (KG)	
	BOX	CARTON	BOX	CARTON	BOX	CARTON
DO-41 DO-41L	196 x 84 x 20	450 x 210 x 250	1000	50K	0.38	20
DO-201AD	305 x 93 x 59	355 x 355 x 355	1000	20K	1.35	28
P6(Aleg)	305 x 93 x 59	355 x 355 x 355	500	10K	1.2	24.5
PBM	357 x 125 x 60	530 x 360 x 340	1000	20K	1.5	32.3
PBDF	495 x 155 x 145	500 x 325 x 305	5000	20K	5.1	21.5
PBP	357 x 125 x 60	530 x 360 x 340	500	10K	1.5	31.5
PBL	375 x 220 x 155	470 x 385 x 455	1000	5K	5.7	30.5
PBPC-6	357 x 125 x 60	560 x 360 x 340	250	5K	1.1	22
PBPC-8	357 x 125 x 60	560 x 360 x 340	250	5K	1.7	35
KBPC	375 x 220 x 365	470 x 390 x 385	500	1K	15.1	31.5
KBPC-W	375 x 220 x 365	470 x 390 x 385	500	1K	14.5	30.0

AMMO BOX PACKAGING

BOX SIZE

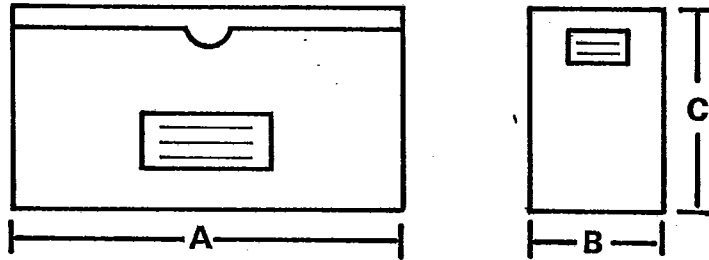

Unit:m. m.

Packaging	Products Outline	Dimension *A*	Dimension *B*	Dimension *C*	Q'ty per BOX
26MM Horizontal Ammo Pack	DO-41 DO-41L(0.6mm Lead)	255	50	95	3K
					3K
52MM Horizontal Ammo Pack	DO-41and DO-41L DO 201AD	250	75	92	3K
					0.8K

CARTON SIZE

Unit:m. m.

Packaging	Products Outline	length	Width	High	Q'ty Per Carton
26MM Horizontal Ammo Pack	DO-41 DO-41L(0.6mm Lead)	330	310	268	42K
					48K
52MM Horizontal Ammo Pack	DO-41and DO-41L DO 201AD	355	355	340	12K

PREFORMED LEAD DRAWING

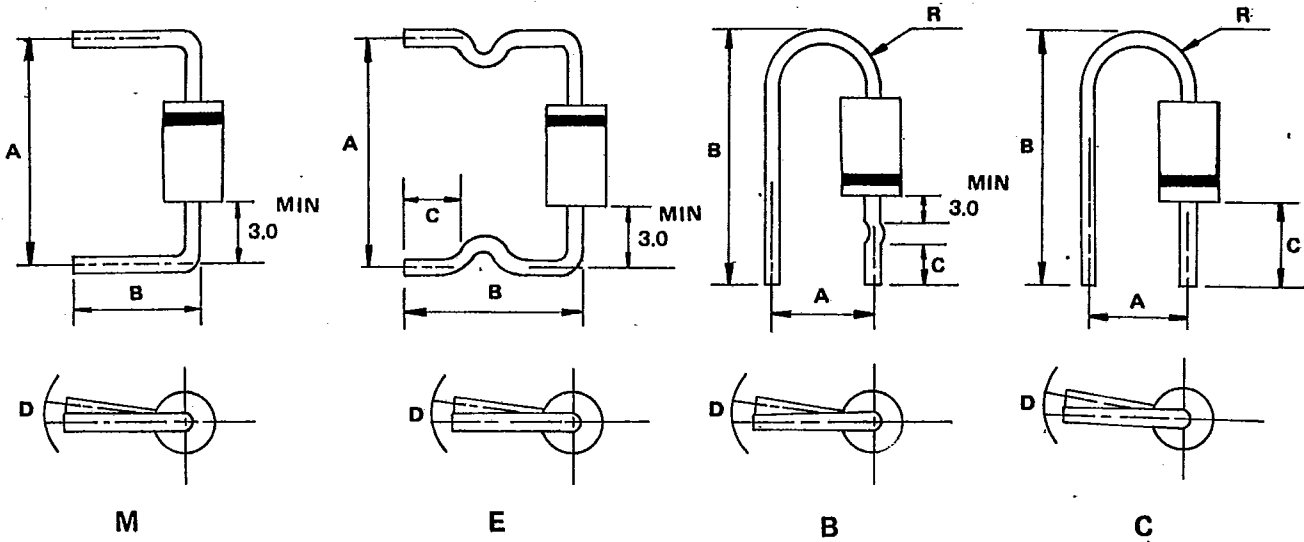

Case type	Preformed type	A (mm)		B (mm)		C (mm)		D (mm)		R (mm)	
		range	tolerance	range	tolerance	range	tolerance	range	tolerance	range	tolerance
D041	M	9.0-20.0	1.0	8.0-22.0	±0.5	—	—	1.5	max	—	—
	E	11.0-20.0	±1.0	11.0-16.0	±1.0	4.0-5.0	±0.5	1.5	max	—	—
	B	7.5	±0.5	19.0-22.0	±0.5	7.5	±0.5	1.5	max	2.5-4.0	Typ
	C	4.5	±0.8	18.0-19.0	±0.5	9.0	±0.5	1.5	max	2.5-4.0	Typ
D0201AD	M	15.0-20.0	±1.0	8.0-22.0	±1.0	—	—	2.0	max	—	—
	E	15.0-20.0	±1.0	10.0-22.0	±1.0	3.0-15.0	±0.5	2.0	max	—	—
P6(Aleg)	M	15.0-20.0	±1.0	8.0-22.0	±1.0	—	—	2.0	max	—	—