

LH5168

CMOS 64K (8K × 8) Static Ram

FEATURES

- 8,192 × 8 bit organization
- Access times: 80/100 ns (MAX.)
- Low-power consumption:
 - Operating:
 - 303 mW (MAX.) LH5168/D/N
 - @ 80 ns
 - 248 mW (MAX.) LH5168/D/N/T/TR
 - @ 100 ns
 - 275 mW (MAX.) LH5168H/HD/HN
 - @ 100 ns
 - Standby:
 - 5.5 μW (MAX.) LH5168/D/N/T/TR
 - 16.5 μW (MAX.) LH5168H/HD/HN
- Fully-static operation
- Three-state outputs
- Single +5 V power supply
- TTL compatible I/O
- Pin compatible to 64K bit EPROM
- Wide temp. range available
 - LH5168: -10 to +70°C
 - LH5168H: -40 to +85°C
- Packages:
 - 28-pin, 600-mil DIP
 - 28-pin, 300-mil SK-DIP
 - 28-pin, 450-mil SOP
 - 28-pin, 8 × 13 mm² TSOP (Type I)

DESCRIPTION

The LH5168 is a static RAM organized as 8,192 × 8 bits. It is fabricated using silicon-gate CMOS process technology.

The LH5168H is designed for wide temperature range from -40 to +85°C.

PIN CONNECTIONS

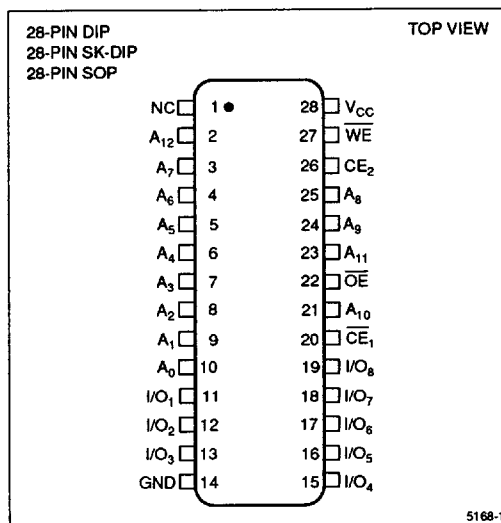
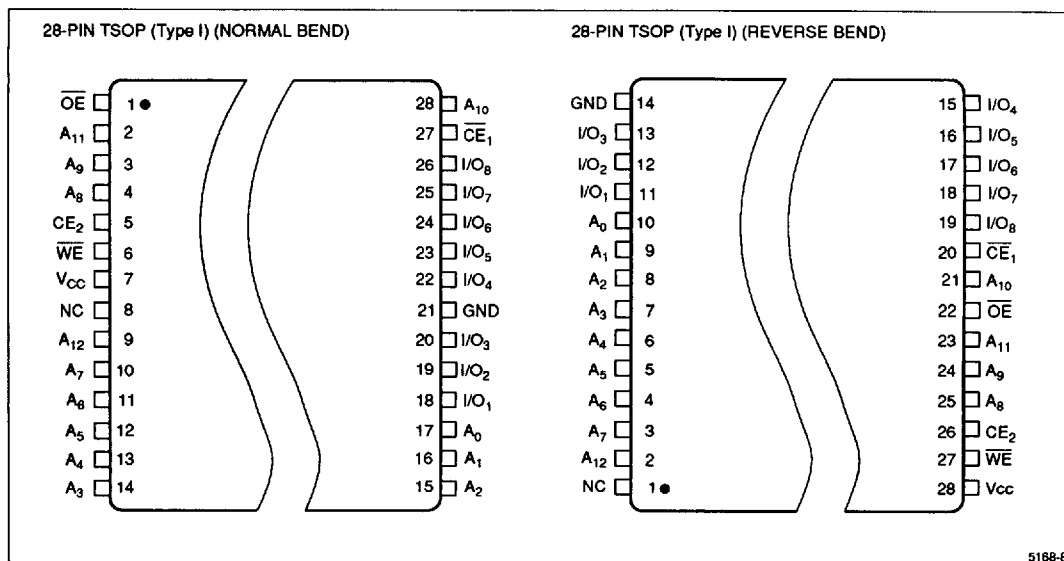

Figure 1. Pin Connections for DIP, SK-DIP, and SOP Packages



5168-B

Figure 2. Pin Connections for TSOP Packages

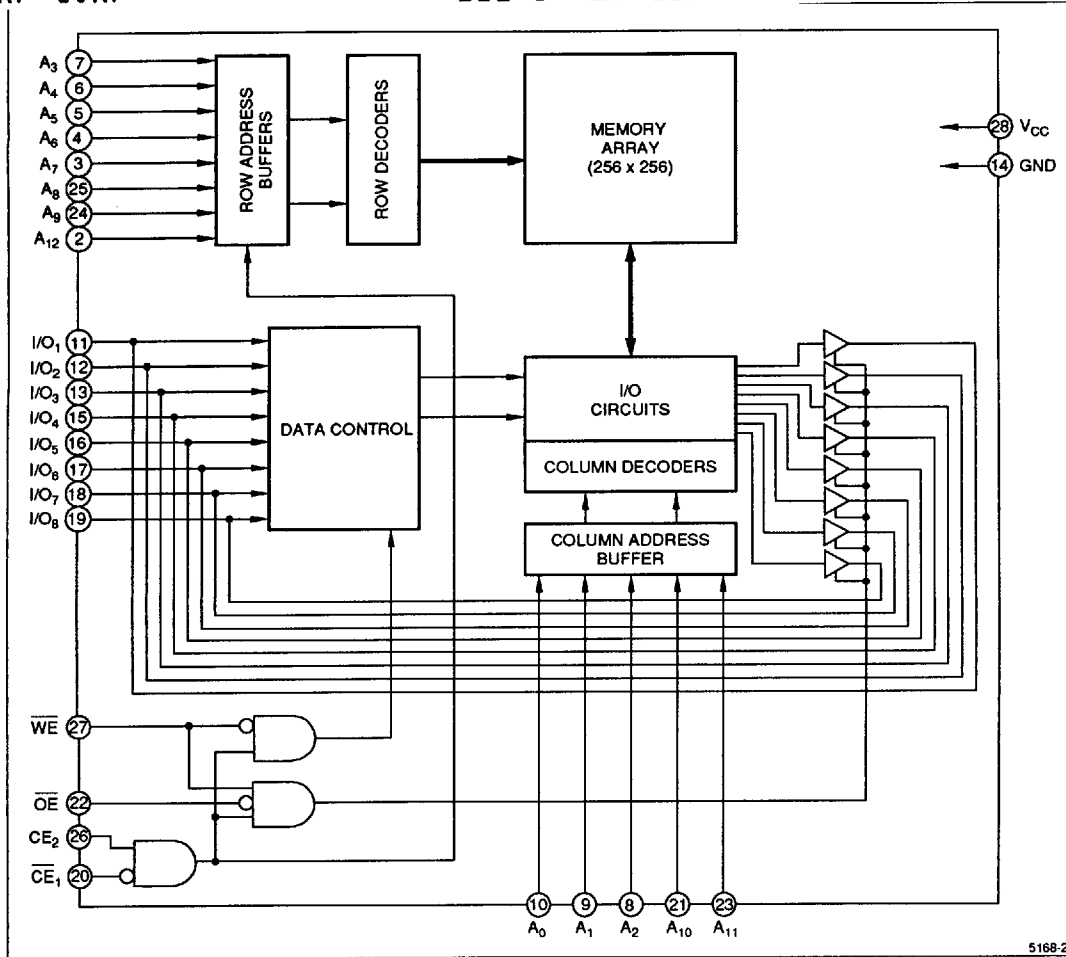

Figure 3. LH5168 Block Diagram

PIN DESCRIPTION

SIGNAL	PIN NAME
A ₀ - A ₁₂	Address inputs
\overline{CE}_1 - \overline{CE}_2	Chip Enable input
\overline{WE}	Write Enable input
\overline{OE}	Output Enable input

SIGNAL	PIN NAME
I/O ₁ - I/O ₈	Data inputs and outputs
V _{CC}	Power supply
GND	Ground
NC	Non-connection

TRUTH TABLE

\overline{CE}_1	CE_2	\overline{WE}	\overline{OE}	MODE	I/O ₁ - I/O ₈	SUPPLY CURRENT	NOTE
H	X	X	X	Deselect	High-Z	Standby (I _{SB})	1
X	L	X	X	Deselect	High-Z	Standby (I _{SB})	1
L	H	L	X	Write	D _{IN}	Operating (I _{CC})	
L	H	H	L	Read	D _{OUT}	Operating (I _{CC})	
L	H	H	H	Output disable	High-Z	Operating (I _{CC})	

NOTE:

1. X = H or L

ABSOLUTE MAXIMUM RATINGS

PARAMETER	SYMBOL	80 ns	100 ns	UNIT	NOTE
		RATING	RATING		
Supply voltage	V _{CC}	-0.3 to +7.0	-0.3 to +7.0	V	1
Input voltage	V _{IN}	-0.5 to V _{CC} +0.5	-0.3 to V _{CC} +0.3	V	1
Operating temperature	T _{opr}	-10 to +70	-10 to +70	°C	2
			-40 to +85	°C	3
Storage temperature	T _{stg}	-55 to +150	-55 to +150	°C	

NOTES:

1. The maximum applicable voltage on any pin with respect to GND.
2. LH5168/D/N
3. LH5168H/HD/HN

RECOMMENDED OPERATING CONDITIONS (Note 1)

PARAMETER	SYMBOL	80 ns			100 ns			UNIT
		MIN.	TYP.	MAX.	MIN.	TYP.	MAX.	
Supply voltage	V _{CC}	4.5	5.0	5.5	4.5	5.0	5.5	V
Input voltage	V _{IH}	2.2		V _{CC} + 0.5	2.2		V _{CC} + 0.3	V
	V _{IL}	-0.5		0.8	-0.3		0.8	V

NOTE:

1. T_A = -10 to +70°C (LH5168/D/N), T_A = -40 to +85°C (LH5168H/HD/HN).

DC CHARACTERISTICS¹ (V_{CC} = 5 V ± 10%)

PARAMETER	SYMBOL	CONDITIONS	MIN.	MAX.	UNIT	NOTE
Input leakage current	I _{LI}	V _{IN} = 0 to V _{CC}		1.0	μA	
Output leakage current	I _{LO}	$\overline{CE}_1 = V_{IH}$ or $CE_2 = V_{IL}$ or $\overline{OE} = V_{IH}$ or $\overline{WE} = V_{IL}$ V _{I/O} = 0 to V _{CC}		1.0	μA	
Operating current	I _{CC}	$\overline{CE}_1 = V_{IL}$, V _{IN} = V _{IL} to V _{IH} CE ₂ = V _{IH} , Outputs open	t _{CYCLE} = 80 ns	55	mA	
		$\overline{CE}_1 = V_{IL}$, V _{IN} = V _{IL} to V _{IH} CE ₂ = V _{IH} , Outputs open	t _{CYCLE} = 100 ns	45 50	mA	2 3
		$\overline{CE}_1 = V_{IL}$, V _{IN} = 0.2 V to V _{CC} - 0.2 V CE ₂ = V _{IH} , Outputs open	t _{CYCLE} = 1.0 μs	10	mA	
Standby current	I _{SB1}	$\overline{CE}_1 = V_{IH}$ or $CE_2 = V_{IL}$		10	mA	
	I _{SB}	CE ₂ ≤ 0.2 V or \overline{CE}_1 , CE ₂ ≥ V _{CC} - 0.2 V	T _A ≤ 70°C T _A ≤ 85°C	1.0 3.0	μA	2 3
Output voltage	V _{OL}	I _{OL} = 2.1 mA		0.4	V	
	V _{OH}	I _{OH} = -1 mA	2.4		V	

NOTES:

1. T_A = -10 to 70°C (LH5168/D/N/T/TR), T_A = -40 to +85°C (LH5168H/HD/HN)
2. LH5168/D/N/T/TR
3. LH5168H/HD/HN

AC CHARACTERISTICS¹(1) READ CYCLE ($V_{CC} = 5 V \pm 10\%$)

PARAMETER	SYMBOL	80 ns		100 ns		UNIT	NOTE
		MIN.	MAX.	MIN.	MAX.		
Read cycle	t_{RC}	80		100		ns	
Address access time	t_{AA}		80		100	ns	
Chip enable access time	(\overline{CE}_1) t_{ACE1}		80		100	ns	
	(CE_2) t_{ACE2}		80		100	ns	
Output enable access time	t_{OE}		40		40	ns	
Output hold time	t_{OH}	10		10		ns	
Chip enable to output in Low-Z	(\overline{CE}_1) t_{LZ1}	10		10		ns	2
	(CE_2) t_{LZ2}	10		10		ns	2
Output enable to output in Low-Z	t_{OLZ}	5		5		ns	2
Chip enable to output in High-Z	(\overline{CE}_1) t_{HZ1}	0	30	0	30	ns	2
	(CE_2) t_{HZ2}	0	30	0	30	ns	2
Output disable to output in High-Z	t_{OHZ}	0	20	0	20	ns	2

NOTES:

- $T_A = -10$ to $+70^\circ\text{C}$ (LH5168/D/N/T/TR), $T_A = -40$ to $+85^\circ\text{C}$ (LH5168H/HD/HN)
- Active output to high-impedance and high-impedance to output active tests specified for a ± 500 mV transition from steady state levels into the test load. $C_{LOAD} = 5$ pF.

(2) WRITE CYCLE ($V_{CC} = 5 V \pm 10\%$)

PARAMETER	SYMBOL	80 ns		100 ns		UNIT	NOTE
		MIN.	MAX.	MIN.	MAX.		
Write cycle time	t_{WC}	80		100		ns	
Chip enable to end of write	t_{CW}	70		80		ns	
Address valid to end of write	t_{AW}	70		80		ns	
Address setup time	t_{AS}	0		0		ns	
Write pulse width	t_{WP}	60		60		ns	
Write recovery time	t_{WR}	0		0		ns	
Data valid to end of write	t_{DW}	40		40		ns	
Data hold time	t_{DH}	0		0		ns	
Output active from end of write	t_{OW}	10		10		ns	1
\overline{WE} to output in High-Z	t_{WZ}	0	30	0	30	ns	1
\overline{OE} to output in High-Z	t_{OHZ}	0	20	0	20	ns	1

NOTE:

- Active output to high-impedance and high-impedance to output active tests specified for a ± 500 mV transition from steady state levels into the test load. $C_{LOAD} = 5$ pF.

AC TEST CONDITIONS

PARAMETER	MODE
Input voltage amplitude	0.6 to 2.4 V
Input rise/fall time	10 ns
Timing reference level	1.5 V
Output load conditions	(1TTL + $C_L = 100$ pF)

SHARP CORP

6LE D ■ 8180798 0009706 320 ■ SRPJ

CAPACITANCE¹ (T_A = 25°C, f = 1MHz)

PARAMETER	SYMBOL	CONDITIONS	MIN.	TYP.	MAX.	UNIT
Input capacitance	C _{IN}	V _{IN} = 0 V			7	pF
Input/output capacitance	C _{IO}	V _{IO} = 0 V			10	pF

NOTE:

1. This parameter is sampled and not production tested.

DATA RETENTION CHARACTERISTICS¹

PARAMETER	SYMBOL	CONDITIONS	MIN.	MAX.	UNIT	NOTE
Data retention voltage	V _{CCDR}	CE ₂ ≤ 0.2 V or CE ₁ , CE ₂ ≥ V _{CC} - 0.2 V	2.0		V	
Data retention current	I _{CCDR}	V _{CCDR} = 3 V, CE ₂ ≤ 0.2 V or CE ₁ , CE ₂ ≥ V _{CCDR} - 0.2 V		0.6	μA	2
				1.5	μA	3
Chip disable to data retention	t _{CDR}		0		ns	
Recovery time	t _{RDR}		t _{RC}		ns	4

NOTES:

1. T_A = -10 to +70°C (LH5168/D/N/T/TR), T_A = -40 to +85°C (LH5168H/HD/HN)
2. LH5168/D/N/T/TR at T_A ≤ 70°C
3. LH5168H/HD/HN at T_A ≤ 85°C
4. t_{RC} = Read cycle time

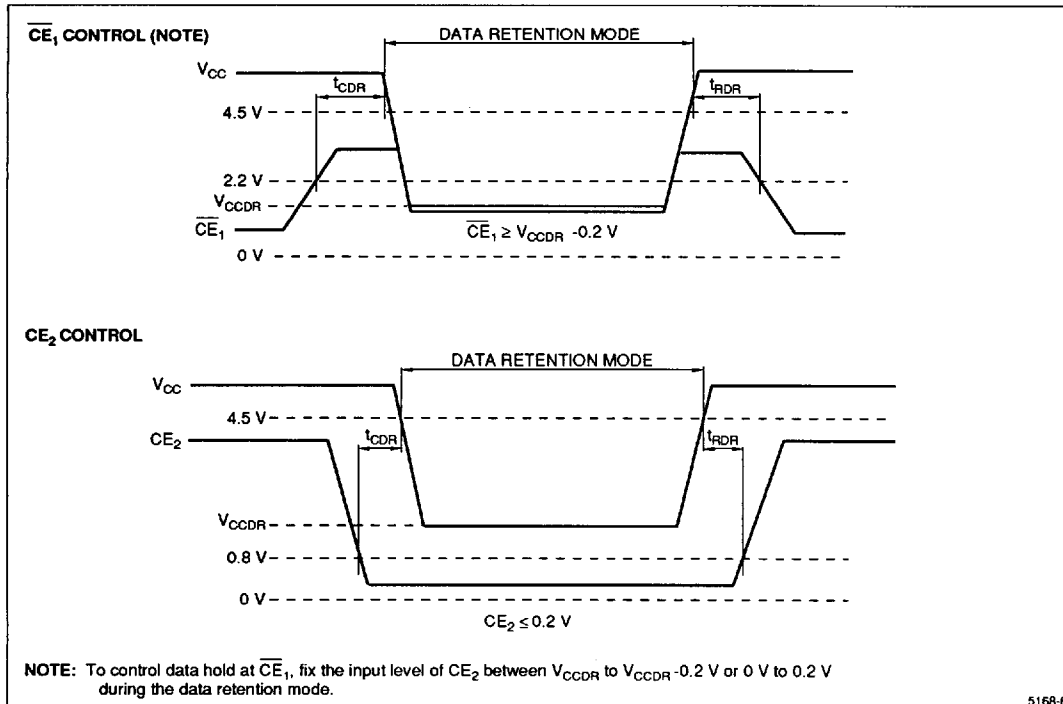

Figure 4. Low Voltage Data Retention

SHARP CORP

61E D ■ 8180798 0009707 267 ■ SRPJ

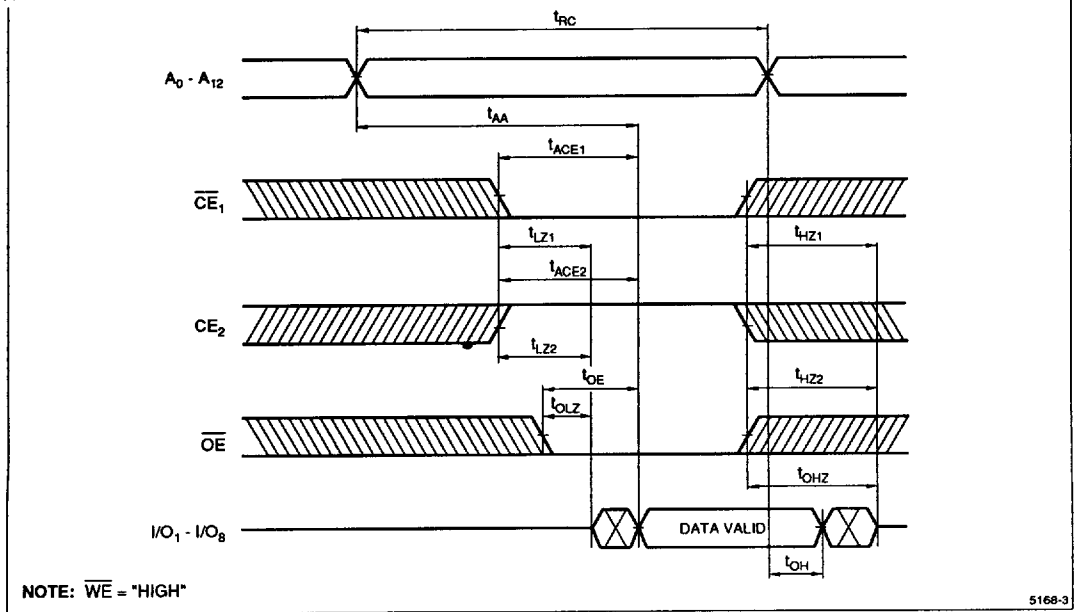
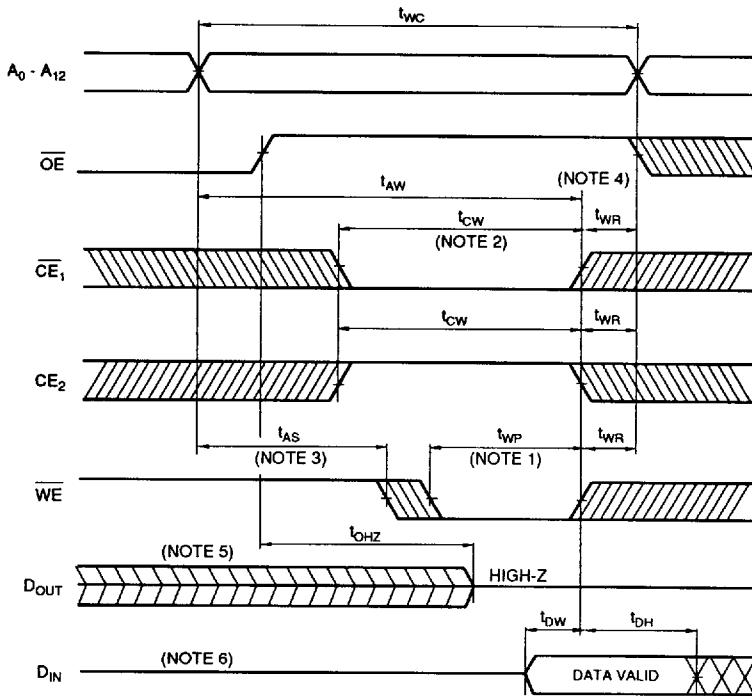

Figure 5. Read Cycle



NOTES:

1. The writing occurs during the overlap (t_{WP}) of \overline{CE}_1 = "LOW", \overline{CE}_2 = "HIGH", and \overline{WE} = "LOW".
2. t_{CW} is defined as the time from the last occurring transition, either \overline{CE}_1 LOW transition or \overline{CE}_2 HIGH transition, to the time when the writing is finished.
3. t_{AS} is defined as the time from address change to writing start.
4. t_{WR} is defined as the time from writing finish to address change.
5. If \overline{CE}_1 LOW transition or \overline{CE}_2 HIGH transition occurs at the same time or after \overline{WE} LOW transition, the output will remain high-impedance.
6. While the I/O pins are in the output state, input signals with the opposite logic level must not be applied.

5168-4

Figure 6. Write Cycle 1

SHARP CORP

61E D ■ 8180798 0009709 03T ■ SRPJ

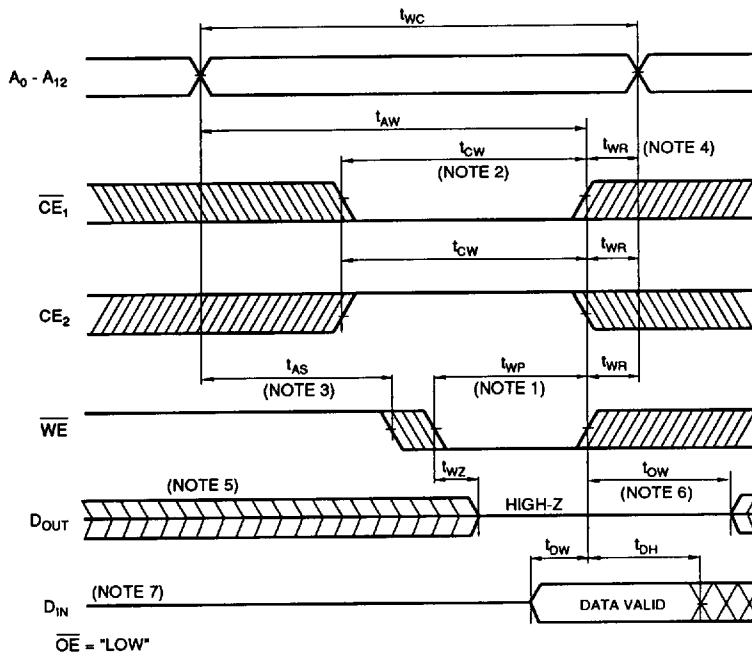
**NOTES:**

1. The writing occurs during the overlap (t_{WP}) of $\overline{CE}_1 = \text{"LOW"}$, $CE_2 = \text{"HIGH"}$, and $\overline{WE} = \text{"LOW"}$.
2. t_{CW} is defined as the time from the last occurring transition, either \overline{CE}_1 LOW transition or CE_2 HIGH transition, to the time when the writing is finished.
3. t_{AS} is defined as the time from address change to writing start.
4. t_{WR} is defined as the time from writing finish to address change.
5. If \overline{CE}_1 LOW transition or CE_2 HIGH transition occurs at the same time or after \overline{WE} LOW transition, the output will remain high-impedance.
6. If \overline{CE}_1 HIGH transition or CE_2 LOW transition occurs at the same time or before \overline{WE} HIGH transition, the output will remain high-impedance.
7. While the I/O pins are in the output state, input signals with the opposite logic level must not be applied.

5168-5

Figure 7. Write Cycle 2

ORDERING INFORMATION

LH5168	X	X	- ##	
Device Type	Operating Temperature	Package	Speed	
				{ 10L 100 Access Time (ns)
				{ 80L 80
				{ Blank 28 pin, 600-mil DIP (DIP 28-P-600)
				{ D 28-pin, 300-mil SK-DIP (SK-DIP28-P-300)
				{ N 28-pin, 450-mil SOP (SOP28-P-450)
				{ T 28-pin, 8 x 13 mm ² TSOP (Type I) (TSOP28-P-0813)
				{ TR 28-pin, 8 x 13 mm ² TSOP (Type I) Reverse Bend (TSOP28-P-0813)
				{ Blank -10 to 70°C
				{ H -40 to +85°C
CMOS 64K (8K x 8) Static RAM				
Example: LH5168D-10L (CMOS 64K (8K x 8) Static RAM, 100 ns, 28-pin, 300-mil SK-DIP)				

5168-7