

Features

- RoHS lead-free-solder and lead-solder-exempted products are available.
- Input voltage ranges up to 150 VDC
- 1 or 2 isolated outputs up to 48 V
- 1200 to 2000 VAC I/O electric strength test
- Extremely wide input voltage ranges
- Immunity according to IEC/EN 61000-4-2, -3, -4, -5, -6
- High efficiency (typ. 84%)
- Input undervoltage lockout
- Inhibit input, adjustable output voltages
- Flex power: flexible load distribution on outputs
- Outputs no-load, overload, and short-circuit proof
- High reliability and no derating
- Operating ambient temperature –40 to +85 °C
- Thermal protection
- Supplementary insulation
- 2" x 1" case with 10.5 mm profile

Safety according to IEC/EN 60950 and UL 60950



¹ 70/110IMX7 models

Description

The IMX7/IMS7 Series of board-mountable 7 Watt DC-DC converters have been designed according to the latest industry requirements and standards. The converters are particularly suitable for use in mobile or stationary applications in transport, railways, industry, or telecom, where variable input voltages or high transient voltages are prevalent.

Covering a total input voltage range from 8.4 V to 150 V with six different models, the converters are available with single and electrically-isolated double outputs from 3.3 up to 48 V with flexible load distribution on double outputs. A shutdown input allows remote on/off.

Features include efficient input and output filtering with good transient and surge protection, low output ripple and noise, consistently high efficiency over the entire input voltage range, and high reliability as well as excellent dynamic response to load and line changes.

The converters provide supplementary insulation with SELV outputs as for instances required in battery-supported systems, where the bus voltage may exceed the SELV limit of

60 V. The converters have been approved by UL. In addition, 70IMX7 and 110IMX7 models are CE-marked.

The circuitry is comprised of integral planar magnetics. All components are automatically assembled and securely soldered onto a single PCB without any wire connections. Magnetic feedback ensures maximum reliability and repeatability in the control loop over all operating conditions. Careful considerations of possible thermal stresses ensure the absence of hot spots, providing long life in environments, where temperature cycles are a reality. The thermal design allows operation at full load up to an ambient temperature of 85 °C in free air without using any potting material. For extremely high vibration environments the case has holes for screw mounting.

Several options, such as open-frame, provide a high level of application-specific engineering and design-in flexibility.

Table of Contents

	Page		Page
Description	1	Electromagnetic Compatibility (EMC)	11
Model Selection	2	Immunity to Environmental Conditions	12
Functional Description	3	Mechanical Data	13
Electrical Input Data	4	Safety and Installation Instructions	13
Electrical Output Data	7	Description of Options	14
Auxiliary Functions	9	EC Declaration of Conformity	15

Model Selection

Table 1: Model Selection

Output 1		Output 2		Output power $P_{o \text{ nom}}$ [W]	Input voltage range [V]	Efficiency η_{typ} [%]	Model	Options ²
$V_{o1 \text{ nom}}$ [V]	$I_{o1 \text{ nom}}$ [A] ¹	$V_{o2 \text{ nom}}$ [V]	$I_{o2 \text{ nom}}$ [A] ¹					
3.3	1.5	-	-	5	8.4 – 36	79	20IMX7-03-8	Z, G
3.3	1.5	-	-	5	14 – 36	79	24IMS7-03-9 ⁴	Z, G
3.3	1.5	-	-	5	16.8 – 75 ³	81	40IMX7-03-8	Z, G
3.3	1.5	-	-	5	36 – 75	79	48IMS7-03-9 ⁴	Z, G
3.3	1.5	-	-	5	40 – 121	79	70IMX7-03-8	Z, G
3.3	1.5	-	-	5	60 – 150	79	110IMX7-03-8	Z, G
5.1	1.2	-	-	6.1	8.4 – 36	80	20IMX7-05-8	Z, G
5.1	1.2	-	-	6.1	14 – 36	81	24IMS7-05-9	Z, G
5.1	1.2	-	-	6.1	16.8 – 75 ³	81	40IMX7-05-8	Z, G
5.1	1.2	-	-	6.1	36 – 75	82	48IMS7-05-9	Z, G
5.1	1.2	-	-	6.1	40 – 121	80	70IMX7-05-8	Z, G
5.1	1.2	-	-	6.1	60 – 150	80	110IMX7-05-8	Z, G
12	0.6	-	-	7.2	14 – 36	84	24IMS7-12-9C ⁴	Z, G
12	0.6	-	-	7.2	36 – 75	84	48IMS7-12-9C ⁴	Z, G
15	0.48	-	-	7.2	14 – 36	84	24IMS7-15-9C ⁴	Z, G
15	0.48	-	-	7.2	36 – 75	84	48IMS7-15-9C ⁴	Z, G
5	0.6	5	0.6	6	8.4 – 36	82	20IMX7-05-05-8	Z, G
5	0.7	5	0.7	7	14 – 36	83	24IMS7-05-05-9	Z, G
5	0.7	5	0.7	7	16.8 – 75 ³	83	40IMX7-05-05-8	Z, G
5	0.7	5	0.7	7	36 – 75	83	48IMS7-05-05-9	Z, G
5	0.7	5	0.7	7	40 – 121	82	70IMX7-05-05-8	Z, G
5	0.7	5	0.7	7	36 – 75	82	110IMX7-05-05-8	Z, G
12	0.25	12	0.25	6	8.4 – 36	84	20IMX7-12-12-8	Z, G
12	0.3	12	0.3	7.2	14 – 36	84	24IMS7-12-12-9	Z, G
12	0.3	12	0.3	7.2	16.8 – 75 ³	84	40IMX7-12-12-8	Z, G
12	0.3	12	0.3	7.2	36 – 75	84	48IMS7-12-12-9	Z, G
12	0.3	12	0.3	7.2	40 – 121	83	70IMX7-12-12-8	Z, G
12	0.3	12	0.3	7.2	60 – 150	84	110IMX7-12-12-8	Z, G
15	0.2	15	0.2	6	8.4 – 36	84	20IMX7-15-15-8	Z, G
15	0.24	15	0.24	7.2	14 – 36	84	24IMS7-15-15-9	Z, G
15	0.24	15	0.24	7.2	16.8 – 75 ³	84	40IMX7-15-15-8	Z, G
15	0.24	15	0.24	7.2	36 – 75	84	48IMS7-15-15-9	Z, G
15	0.24	15	0.24	7.2	40 – 121	83	70IMX7-15-15-8	Z, G
15	0.24	15	0.24	7.2	60 – 150	84	110IMX7-15-15-8	Z, G
24	0.13	24	0.13	6.2	8.4 – 36	84	20IMX7-24-24-8	Z, G
24	0.15	24	0.15	7.2	14 – 36	84	24IMS7-24-24-9	Z, G
24	0.15	24	0.15	7.2	16.8 – 75 ³	84	40IMX7-24-24-8	Z, G
24	0.15	24	0.15	7.2	36 – 75	84	48IMS7-24-24-9	Z, G
24	0.15	24	0.15	7.2	40 – 121	83	70IMX7-24-24-8	Z, G
24	0.15	24	0.15	7.2	60 – 150	84	110IMX7-24-24-8	Z, G

¹ Flexible load distribution on double outputs possible.

² If only one output voltage is required, connect both outputs of double-output models in parallel.

³ Operation at low input voltage possible, if P_o is reduced to approx. 80% of $P_o \text{ nom}$ at $V_{i \text{ min}} = 14.1 \text{ V}$.

⁴ Not for new designs

Part Number Description

Input voltage range V_i	
8.4 – 36 V	20
14 – 36 V	24
16.8 – 75 V	40
36 – 75 V	48
40 – 121 V	70
60 – 150 V	110
Series	IMX7, IMS7
Output voltage of output 1	03, 05, 12, 15, 24
Output voltage of output 2	05, 12, 15, 24
Operating ambient temperature T_A	
-40 to 85 °C	-8
-40 to 71 °C	-9
Options:	
Open frame	Z
RoHS compliant for all six substances	G

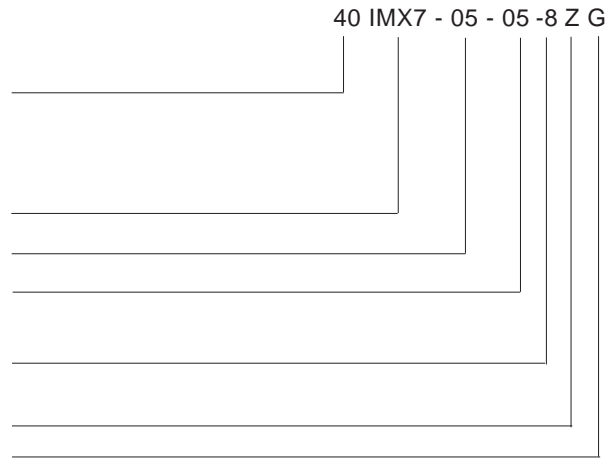

Example: 40IMX7-05-05-8ZG: DC-DC converter, input voltage range 16.8 – 75 V, 2 outputs providing each 5 V, 700 mA, temperature range -40 to 85 °C, open frame, RoHS compliant for all six substances.

Obsolete options:

Surface mount version	M
C-pinout	C

Functional Description

The IMX7/IMS7 Series DC-DC converters are feedback-controlled flyback converters using current mode PWM (Pulse Width Modulation).

In the case of single-output models, the output is directly sensed and fed back to the primary control circuit via a pulse transformer, resulting in tight regulation of the output voltage. The R input is referenced to the secondary side and allows for programming the output voltages in the range 75 to 105% of $V_{o\ nom}$, using either an external resistor or an external voltage source.

For double-output models, the output voltage is sensed by a separate transformer winding close to the secondary and fed

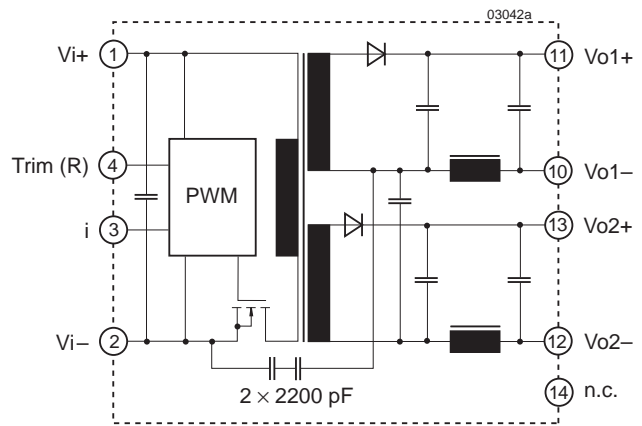

Fig. 2
Block diagram for dual-output models with standard pinout.

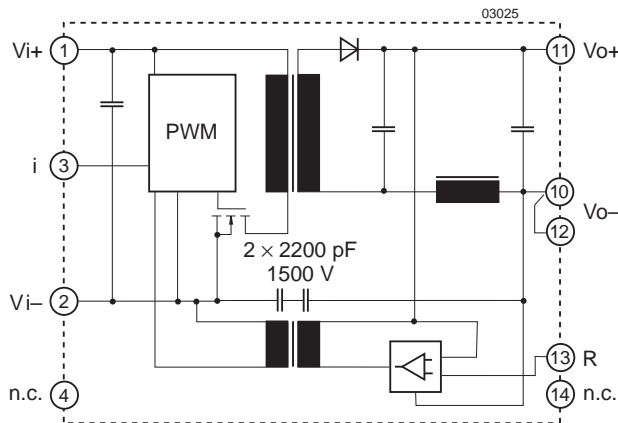

Fig. 1
Block diagram for single-output models with standard pinout.

back to the primary control circuit. Close magnetic coupling is provided by the planar construction, ensuring very good regulation, and allowing for flexible load distribution. The Trim input of double-output models is referenced to the primary side, and allows for programming the output voltages in the range of 100 to 105% of $V_{o\ nom}$ by means of an external resistor, or within 75 to 100% of $V_{o\ nom}$, using an external voltage source.

Current limitation is provided by the primary circuit, thus limiting the total output current ($I_{o\ nom}$ for the single- and the sum $I_{o1\ nom} + I_{o2\ nom}$ for double-output models).

The inhibit input i allows remote control of the outputs; pin i must be connected to V_{i-} to activate the converter.

Electrical Input Data

General conditions:

- $T_A = 25\text{ °C}$, unless T_C is specified.
- Connector pin i connected with V_i .
- Trim or R input not connected.

Table 2a: Input data of IMX7

Input			20IMX7			40IMX7			70IMX7			110IMX7			
Characteristics		Conditions	min	typ	max	min	typ	max	min	typ	max	min	typ	max	Unit
V_i	Input voltage range ¹	$T_C \text{ min} - T_C \text{ max}$	8.4		36	16.8 ⁶		75	40		121	60		150	V
$V_{i \text{ nom}}$	Nominal input voltage	$I_o = 0 - I_o \text{ nom}$	20			40			70			110			
$V_{i \text{ sur}}$	Repetitive surge voltage	abs. max input (3 s)	50 ⁵			100			150						
$t_{\text{start up}}$	Converter ² start-up time	switch on	0.25		0.5		0.25		0.5		0.25		0.5		s
		inh. release			0.1				0.1				0.1		
t_{rise}	Rise time ²	$V_{i \text{ nom}}$ resistive load	5		5		5		5		5		5		ms
		$I_o \text{ nom}$ capacitive load	12		12		12		12		12		12		
I_o	No load input current	$I_o = 0, V_{i \text{ min}} - V_{i \text{ max}}$	15	30		8	15		8	15		8	15		mA
C_i	Input capacitance	(for surge calculation)	4.7			0.5			0.2			0.2			µF
$V_{i \text{ inh}}$	Inhibit voltage	converter operating	-10	+0.8		-10	+0.8		-10	+0.8		-10	+0.8		V
		converter inhibited	2.4	$V_{i \text{ max}}$ or open		2.4	$V_{i \text{ max}}$ or open		2.4	$V_{i \text{ max}}$ or open		2.4	$V_{i \text{ max}}$ or open		
$I_{i \text{ inh}}$	Inhibit current	converter operating	-0.5		-0.5		-0.5		-0.5		-0.5		-0.5		mA
		converter inhibited	1		1		1		1		1		1		
$I_{i \text{ inh}}$	Input current when the converter is inhibited	$V_{i \text{ min}} - V_{i \text{ max}}$	3		3		3		3		3		3		
$I_{i \text{ nr p}}$	Inrush peak current	$V_i = V_{i \text{ nom}}$ ⁴	3.8		3.7		4.2		5.6		5.6		5.6		A
f_s	Switching frequency	$V_{i \text{ min}} - V_{i \text{ max}}, I_o = 0 - I_o \text{ nom}$	approx. 400			approx. 400			approx. 400			approx. 300			kHz
$I_{i \text{ rr}}$	Reflected ripple current	$I_o = 0 - I_o \text{ nom}$	50			30			20			10			mA _{pp}
$V_{i \text{ RFI}}$	Input RFI level conducted	EN 55022 ³	B			B			B			B			

¹ $V_{i \text{ min}}$ will not be as stated, if V_o is increased above $V_o \text{ nom}$ by use of the R or Trim input. If the output voltage is set to a higher value, $V_{i \text{ min}}$ will be proportionally increased.

² Measured with a resistive and the max. admissible capacitive load.

³ Measured with a lead length of 0.1 m, leads twisted. Double-output models with both outputs in parallel. 70/110 IMX7 models need an external capacitor at the input, e.g., 1 µF film or ceramic.

⁴ Source impedance according to ETS 300132-2, version 4.3, at $V_{i \text{ nom}}$.

⁵ The DC-DC converter shuts down automatically at approx. 38 V.

⁶ Operation at lower input voltage possible: P_o approx. 80% of $P_o \text{ nom}$ at $V_{i \text{ min}} = 14.4\text{ V}$.

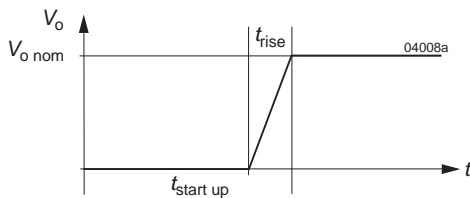

Fig. 3
Converter start-up and rise time

Table 2b: Input data of IMS7; general conditions as in table 2a

Input			24IMS7			48IMS7			Unit	
Characteristics		Conditions	min	typ	max	min	typ	max		
V_i	Input voltage range ¹		$T_{C\ min} - T_{C\ max}$		14		36	36	75	V
$V_{i\ nom}$	Nominal input voltage		$I_o = 0 - I_{o\ nom}$		24		48			
$V_{i\ sur}$	Repetitive surge voltage		abs. max input (3 s)		50		100			
$t_{start\ up}$	Converter ² start-up time	switch on	Worst case condition at $V_{i\ min}$ and full load		0.25	0.5	0.25	0.5	s	
		inh. release			0.1		0.1			
t_{rise}	Rise time ²		$V_{i\ nom}$	resistive load	5		5		ms	
			$I_o\ nom$	capacitive load	12		12			
I_o	No load input current		$I_o = 0, V_{i\ min} - V_{i\ max}$		12	24	6	12	mA	
C_i	Input capacitance		(for surge calculation)		0.8		0.5		μF	
V_{inh}	Inhibit voltage		converter operating		-10	+0.8	-10	+0.8	V	
			converter inhibited		2.4	$V_{i\ max}$	2.4	$V_{i\ max}$		
I_{inh}	Inhibit current		converter operating		-0.5		-0.5		mA	
			converter inhibited		1		1			
$I_{i\ inh}$	Input current when the converter is inhibited		$V_{i\ min} - V_{i\ max}$		3		3			
$I_{inr\ p}$	Inrush peak current		$V_i = V_{i\ nom}$ ⁴		4.0		3.9		A	
f_s	Switching frequency		$V_{i\ min} - V_{i\ max}, I_o = 0 - I_{o\ nom}$		approx. 330		approx. 330		kHz	
$I_{i\ rr}$	Reflected ripple current		$I_o = 0 - I_{o\ nom}$		40		30		mA _{pp}	
$V_{i\ RFI}$	Input RFI level conducted		EN 55022 ³		B		B			

¹ $V_{i\ min}$ will not be as stated, if V_o is increased above $V_{o\ nom}$ by use of the R or Trim input. If the output voltage is set to a higher value, $V_{i\ min}$ will be proportionally increased.

² Measured with a resistive and the max. admissible capacitive load.

³ Measured with a lead length of 0.1 m, leads twisted. Double-output models with both outputs in parallel. 70/110 IMX7 models need an external capacitor at the input, e.g., 1 μF film or ceramic.

⁴ Source impedance according to ETS 300132-2, version 4.3, at $V_{i\ nom}$

Input Transient Voltage Protection

In many applications transient voltages on the input of the converter may occur and are possibly caused by short circuits between Vi+ and Vi-, where the network inductance may cause high energy pulses.

In order to protect the converters, transient suppressors are fitted to the input; see table below:

Table 3: Built-in transient voltage suppressor

Model	Breakdown Voltage $V_{BR\ nom}$	Peak Power at 1 ms P_P	Peak Pulse Current I_{PP}
20IMX7 ¹	overvoltage lockout at approx. 38 V		
24IMS7 ²	53 V	600 W	7.7 A
40IMX7 ²	100 V	1500 W	11 A
48IMS7 ²	100 V	600 W	4.1 A
70IMX7 ²	144 V	600 W	2.9 A
110IMX7 ²	167 V	600 W	2.5 A

¹ The built-in overvoltage trigger shuts down the converter at approx. 38 V protecting the input up to 50 V. For higher transient voltages an external suppressor or voltage limiting circuit as, e.g., for IEC/EN 61000-4-5, level 2 compliance should be provided.

² If transients generating currents above the peak pulse current are possible, an external limiting network such as the circuit recommended for IEC/EN 61000-4-5, level 2 compliance, is necessary.

To achieve IEC/EN 61000-4-5, level 2 compliance, an additional inductor and capacitor should be provided externally as shown in the figure below. The components should have similar characteristics as listed in table 4.

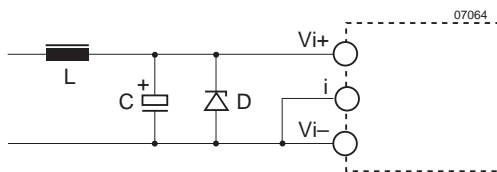

Fig. 4

Example for external circuitry to comply with IEC/EN 61000-4-5, level 2 (transzorb D only for 20IMX7).

Table 4: Components for external circuitry to comply with IEC/EN 61000-4-5

Model	L	C	D
20IMX7	330 μ H, 1 A, 0.115 Ω	68 μ F, 63 V	1.5KE39A
24IMS7	330 μ H, 0.6 A, 0.42 Ω	68 μ F, 63 V	n.a.
40IMX7	330 μ H, 0.6 A, 0.42 Ω	68 μ F, 100 V	n.a.
48IMS7	330 μ H, 0.6 A, 0.42 Ω	68 μ F, 100 V	n.a.
70IMX7	1000 μ H, 0.6 A, 0.42 Ω	68 μ F, 100 V	n.a.
110IMX7	330 μ H, 0.2 A	200 μ F, 200 V	n.a.

Note: Suppressor diode D is only necessary for 20IMX7 models. To withstand 150 V transients according to 19 Pfl 1, applicable for 40 IMX7 models, the same external circuitry with similar components as for IEC/EN 61000-4-5, level 2 compliance can be used.

Input Fuse and Reverse Polarity Protection

The suppressor diode on the input also provides for reverse polarity protection by conducting current in the reverse direction, thus protecting the converter. An external fuse is required to limit this current. We recommend for:

- 20IMX7 and 24IMS7 a fast 2 A (F2A) fuse
- 40IMX7 and 48IMS7 a fast 1 A (F1A) fuse
- 70IMX7 a fast 0.63 A (F.63A) fuse
- 110IMX7 a fast 0.63 A (F.63A) fuse.

Inrush Current

The inrush current has been kept as low as possible by choosing a very small input capacitance. A series resistor may be inserted in the input line to limit this current further.

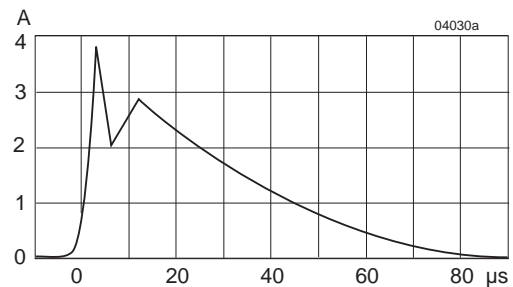

Fig. 5

Typical inrush current at $V_{i\ nom}$, $P_{o\ nom}$ measured according to ETS 300132-2 (40IMX7).



Electrical Output Data

General conditions:

- $T_A = 25\text{ °C}$, unless T_C is specified.
- Pin i connected with V_i- ; Trim or R input left open-circuit.

Table 5a: Output data for single-output models

Output		$V_{o\text{ nom}}$	3.3 V			5.1 V			12 V			15 V			Unit
Characteristics		Conditions	min	typ	max	min	typ	max	min	typ	max	min	typ	max	
V_o	Output voltage setting	$V_{i\text{ nom}}$	3.28	3.32		5.07	5.13		11.82	12.18		14.78	15.22	V	
$I_{o\text{ nom}}$	Output current (nom.)	$V_{i\text{ min}} - V_{i\text{ max}}$	1.5			1.2			0.6			0.48			A
$I_{o\text{ L}}$	Current limit ²	$V_{i\text{ nom}}$	3.0			2.4			1.2			1.1			
ΔV_o	Line and load regulation	$V_{i\text{ min}} - V_{i\text{ max}}$ $I_o = (0.05 - 1) I_{o\text{ nom}}$	± 1			± 1			± 1			± 1			%
v_o	Output voltage noise other models 110IMX7	$V_{i\text{ min}} - V_{i\text{ max}}$ ⁵ $I_o = I_{o\text{ nom}}$ ⁶	70			70			120			150			mV _{pp}
			20 40			20 40			25 50			30 60			
			40 50			40 50			n.a.			n.a.			
$V_{o\text{ clp}}$	Output overvoltage limit ⁷	Minimum load 1%	115	130		115	130		115	130		115	130	%	
$C_{o\text{ ext}}$	Admissible capacitive load		2500			2000			300			200			μF
$V_{o\text{ d}}$	Dynamic load regulation	Voltage deviat.	± 250			± 250			± 330			± 330			mV
		Recovery time	1			1			1			1			ms
α_{V_o}	Temperature coefficient $\Delta V_o / \Delta T_C$ ($T_{C\text{ min}}$ to $T_{C\text{ max}}$)	$V_{i\text{ min}} - V_{i\text{ max}}$ $I_o = (0.05 - 1) I_{o\text{ nom}}$	± 0.02			± 0.02			± 0.02			± 0.02			%/K

Table 5b: Output data for double-output models

Output		$V_{o\text{ nom}}$	2 x 5 V			2 x 12 V			2 x 15 V			2 x 24 V			Unit
Characteristics		Conditions	min	typ	max	min	typ	max	min	typ	max	min	typ	max	
V_{o1} V_{o2}	Output voltage setting	IMX7 $V_{i\text{ nom}}$ $I_{o1} = I_{o2} = 0.5 I_{o\text{ nom}}$	4.96	5.04		11.90	12.10		14.88	15.12		23.81	24.19	V	
		IMS7 $V_{i\text{ nom}}$ $I_{o1} = I_{o2} = 0.5 I_{o\text{ nom}}$	4.92	5.08		11.82	12.18		14.78	15.22		23.64	24.36		
$I_{o\text{ nom}}$	Output current (nom.) ¹	$V_{i\text{ min}} - V_{i\text{ max}}$	2 x 0.6			2 x 0.25			2 x 0.2			2 x 0.13			A
	other models		2 x 0.7			2 x 0.3			2 x 0.24			2 x 0.15			
$I_{o\text{ L}}$	Current limit ^{2,3}	20IMX7 $V_{i\text{ nom}}$	2.4			1.0			0.95			0.5			
		other models	2.8			1.2			1.1			0.6			
ΔV_{o1}	Line regulation	$V_{i\text{ min}} - V_{i\text{ max}}$, $I_{o\text{ nom}}$	± 1			± 1			± 1			± 1			%
ΔV_{o1}	Load regulation ⁴	$V_{i\text{ nom}}$, $(0.1 - 1) I_{o\text{ nom}}$	± 3			± 3			± 3			± 3			
$v_{o1,2}$	Output voltage noise	$V_{i\text{ min}} - V_{i\text{ ma}}$ ⁵ $I_o = I_{o\text{ nom}}$ ⁶	80			120			150			240			mV _{pp}
			20 40			25 50			30 60			50 100			
$V_{o\text{ clp}}$	Output overvoltage limit ⁷	Minimum load 1%	115	130		115	130		115	130		115	130	%	
$C_{o\text{ ext}}$	Admissible capacitive load ³		2000			300			200			100			μF
$V_{o\text{ d}}$	Dynamic load regulation	Voltage deviat.	± 150			± 330			± 350			± 600			mV
		Recovery time	1			1			1			1			
α_{V_o}	Temperature coefficient $\Delta V_o / \Delta T_C$ ($T_{C\text{ min}}$ to $T_{C\text{ max}}$)	$V_{i\text{ min}} - V_{i\text{ max}}$ $I_o = (0.05 - 1) I_{o\text{ nom}}$	± 0.02			± 0.02			± 0.02			± 0.02			%/K

¹ Each output is capable of delivering full output power $P_{o\text{ nom}}$ according to table *Model Selection*.

² The current limit is primary side controlled.

³ Measured with both outputs connected in parallel.

⁴ Conditions for specified output. Other output loaded with constant current $I_o = 0.5 I_{o\text{ nom}}$.

⁵ BW = 20 MHz

⁶ Measured with a probe according to EN 61204.

⁷ The overvoltage protection is not tracking with the R control.

Thermal Considerations

If the converter, mounted on a PCB, is located in free, quasi-stationary air (convection cooling) at the maximum ambient temperature $T_{A \max}$ (see table *Temperature specifications*) and is operated at nominal input voltage and output power, the case temperature T_C measured at the measuring point of case temperature (see *Mechanical Data*) will approach $T_{C \max}$ after the warm-up phase. However, the relationship between T_A and T_C depends heavily on the conditions of operation and integration into a system, such as input voltage, output current, airflow, temperature of surrounding components and surfaces, and the properties of the printed circuit board. $T_{A \max}$ is therefore only an indicative value, and under practical operating conditions, T_A may be higher or lower.

Caution: The case temperature T_C measured at the measuring point of case temperature (see *Mechanical Data*) may under no circumstances exceed the specified maximum. The installer must ensure that under all operating conditions T_C remains within the limits stated in the table *Temperature specifications*.

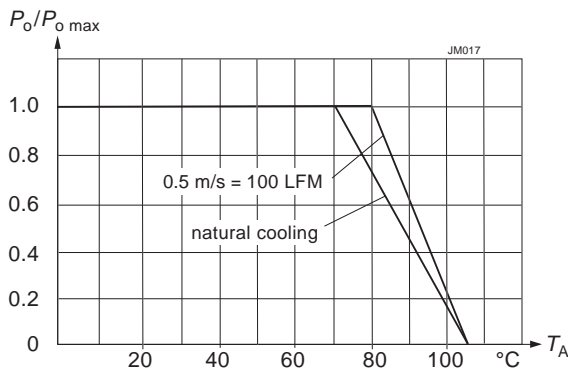

Fig. 6
Maximum allowed output power versus ambient temperature

Short-Circuit Behavior

The current limitation shuts down the converter, when a short circuit is applied to the output. It acts self-protecting, and automatically recovers after removal of the overload condition.

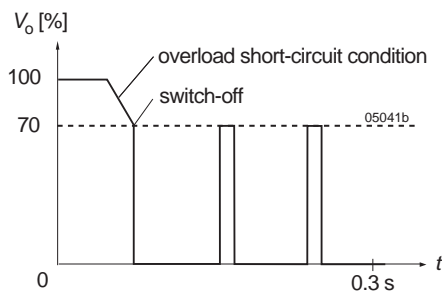

Fig. 7
Overload switch-off (hiccup mode).

Output Overvoltage Protection

The outputs are protected against overvoltage by Zener diodes. In the event of an overvoltage, the converter will shut down and attempt to restart automatically. The main purpose of this feature is to protect against possible overvoltage, which could occur due to a failure in the feedback control circuit. The converters are not designed to withstand external overvoltages applied to the outputs.

Connection in Series or Parallel

The outputs of single- or double-output models can be connected in series without any precautions, taking into consideration that the output voltage should remain below 60 V for SELV operation.

Both outputs of double-output models can be connected in parallel without any precautions. Several converters (single- or double-output models) with equal output voltage can be put in parallel and will share their output current quite equally. However, this may cause start-up problems and is only recommended in applications, where one converter is able to deliver the full load current, e.g., in true redundant systems.

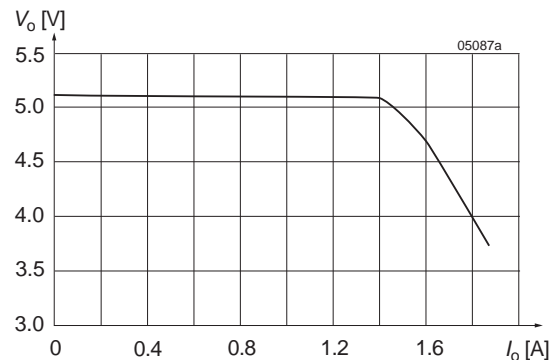

Fig. 8a
 V_o versus I_o (typ.) of single-output models with $V_o = 5.1$ V

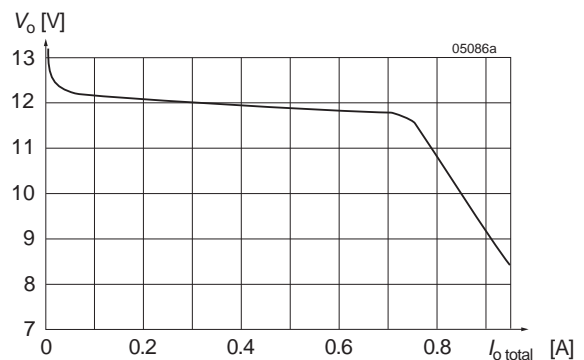

Fig. 8b
 V_o versus I_o (typ.) of double-output models (2×12 V) with both outputs in parallel

Typical Performance Curves

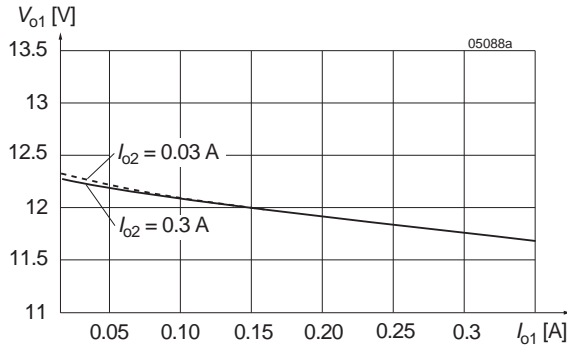

Fig. 9
Cross load regulation (typ.) of double-output models (2 × 12 V). The cross-load effect is negligible.

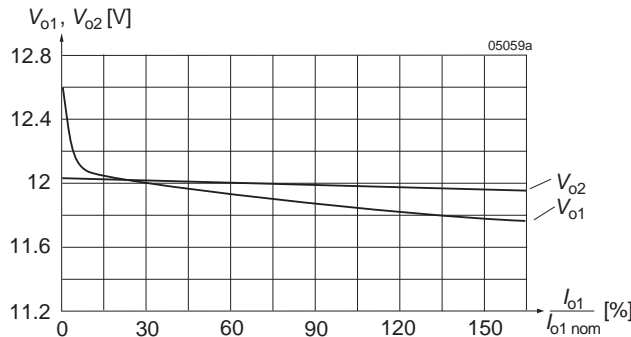

Fig. 10
Flexible load distribution on double-outputs models (2 × 12 V) with load variation from 0 to 150% of $P_{o1\ nom}$ on output 1. Output 2 loaded with 25% of $P_{o2\ nom}$.

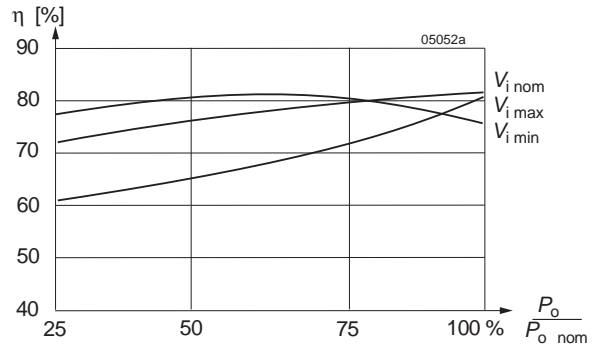

Fig. 11
Efficiency versus input voltage and load. Typical values (40IMX7-12-12-8).

Auxiliary Functions

Inhibit Function

The output(s) of the converter may be enabled or disabled by means of a logic signal (TTL, CMOS, etc.) applied to the inhibit pin. No output voltage overshoot will occur, when the converter is turned on. If the inhibit function is not required, the inhibit pin

should be connected to V_{i-} to enable the output (active low logic, fail safe).

Converter operating:	-10 V to 0.8 V	
Converter inhibited		
or inhibit pin i left open:	2.4 V to $V_{i\ max}$	(20/40IMX7, 24/48IMS7)
	2.4 V to 75 V	(70/110IMX7)

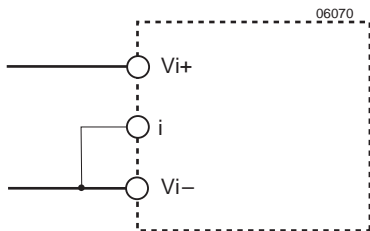

Fig. 12
If the inhibit is not used, the inhibit pin should be connected to V_{i-}

Adjustable Output Voltage

As a standard feature, all IMX7 and IMS7 converters offer adjustable output voltage(s) by using a control pin. If this pin is left open-circuit, the output voltage is set to $V_{o\ nom}$. The output voltage is adjustable in the range of 75 to 105% of $V_{o\ nom}$. The circuit works for single- and double-output models in a different way. For output voltages $V_o > V_{o\ nom}$, the minimum input voltage $V_{i\ min}$ (see *Electrical Input Data*) increases proportionally to $V_o/V_{o\ nom}$.

Single-output models with R-input:

The R input (pin 13) is referenced to the secondary side of the converter. Adjustment of the output voltage is possible by means of either an external resistor or a voltage source.

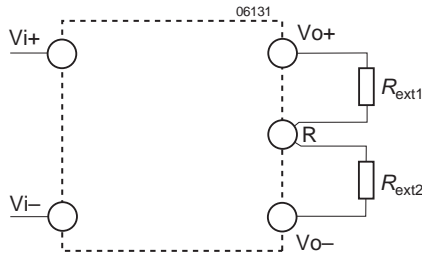

Fig. 13

Output voltage control with external resistor

- a) Adjustment by means of an external resistor:
Depending upon the value of the required output voltage, a resistor R_{ext1} or R_{ext2} shall be connected as shown in the figure below:

Either: R_{ext1} between the R pin and $Vo-$ to achieve an output voltage adjustment range of $V_o = 75$ to 100% of $V_{o\ nom}$ (85 to 100% for 3.3 V outputs):

$$R_{ext1} \approx 4\text{ k}\Omega \cdot \frac{V_o}{V_{o\ nom} - V_o}$$

or: R_{ext2} between the R pin and $Vo+$ to achieve an output voltage range of approximately $V_o = 100$ to 105% of $V_{o\ nom}$:

$$R_{ext2} \approx 4\text{ k}\Omega \cdot \frac{(V_o - 2.5\text{ V})}{2.5\text{ V} \cdot (V_o/V_{o\ nom} - 1)}$$

- b) Adjustment by means of an external voltage V_{ext} between $Vo-$ and R pin.
The control voltage is 1.96 to 2.62 V and allows for adjustment in the range of 75 to 105% of $V_{o\ nom}$.

$$V_{ext} \approx \frac{V_o \cdot 2.5\text{ V}}{V_{o\ nom}}$$

Caution: Applying an external voltage $>2.75\text{ V}$ may damage the converter.

Note: Attempting to adjust the output below this range will cause the converter to shut down (hiccup mode).

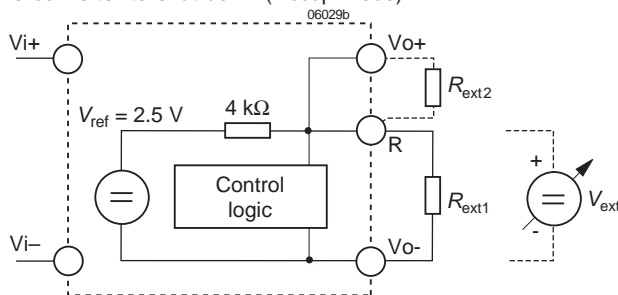

Fig. 14

Output voltage adjust for single-output models

Double-output models with Trim input:

The Trim input (pin 4) of double-output models is referenced to the primary side. The figure below shows the circuitry.

Adjustment of the output voltage is possible in the range of 100 to 105% of $V_{o\ nom}$ using an external resistor, or in the range of 75 to 105% of $V_{o\ nom}$ using an external voltage source.

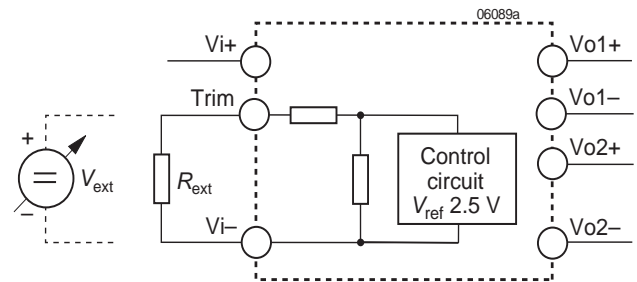

Fig. 15

Output voltage adjust for double-output models

- a) Adjustment by means of an external resistor R_{ext} .

Programming of the output voltage by means of an external resistor R_{ext1} is possible within a limited range of 100 to 105% $V_{o\ nom}$. R_{ext} should be connected between pin 4 and $Vi-$. The following table indicates suitable resistor values for typical output voltages under nominal conditions ($V_{i\ nom}$, $I_o = 0.5 I_{o\ nom}$), with paralleled outputs or equal load conditions on each output.

Caution: Connection of R_{ext} to $Vi+$ may damage the converter.

Table 6: R_{ext} for $V_o > V_{o\ nom}$
approximate values ($V_{i\ nom}$, $I_{o1} = I_{o2} = 0.5 I_{o1/2\ nom}$)

V_o [% $V_{o\ nom}$]	R_{ext} [k Ω]
105 to 108 (107 typically)	0
105	1.5
104	5.6
103	12
102	27
101	68
100	∞

- b) Adjustment by means of an external voltage source V_{ext} .
For external output voltages in the range of 75 to 105% of $V_{o\ nom}$ a voltage source V_{ext} (0 to 20 V) is required, connected to the Trim-input (pin 4) and $Vi-$. The table below indicates typical V_o versus V_{ext} values under nominal conditions ($V_{i\ nom}$, $I_o = 0.5 I_{o\ nom}$), with paralleled outputs or equal load conditions on each output. Direct paralleling of the Trim-inputs of converters connected in parallel is feasible.

Note: Applying a control voltage greater than 20 V will set the converter into a hiccup mode.

Table 7: V_{ext} for $V_o = 75$ to 105% $V_{o\ nom}$;
typical values ($V_{i\ nom}$, $I_{o1} = I_{o2} = 0.5 I_{o1/2\ nom}$)

V_o [% $V_{o\ nom}$]	V_{ext} [V]
≥ 105	0
102	1.6
95	4.5
85	9
75	13

Electromagnetic Compatibility (EMC)

A suppressor diode together with an input filter form an effective protection against high input transient voltages, which

typically occur in many installations, but especially in battery-driven mobile applications.

Electromagnetic Immunity

Table 8: Immunity type tests

Phenomenon	Standard	Class level	Coupling mode ¹	Value applied	Waveform	Source imped.	Test procedure	In oper.	Per-form. ²
Electrostatic discharge to case ⁵	IEC/EN 61000-4-2	2	contact discharge	4000 V _p	1/50 ns	330 Ω	10 positive and 10 negative discharges	yes	B
		3	air discharge	8000 V _p					
Electromagnetic field	IEC/EN	3 ⁶ 2 ³	antenna	10 V/m 3 V/m ³	AM 80% 1 kHz	n.a.	80 – 1000 MHz	yes	A
	ENV 50204	3 2 ³	antenna	10 V/m 3 V/m ³	PM, 50% duty cycle, 200 Hz repetition frequ.	n.a.	900 MHz	yes	A
Electrical fast transients/burst	IEC/EN 61000-4-4	4 3 ³	direct +i/-i	4000 V _p 2000 V _p ³	bursts of 5/50 ns 5 kHz repet. rate, transients with 15 ms burst duration, and 300 ms period	50 Ω	60 s positive, 60 s negative transients per coupling mode	yes	B
Surges	IEC/EN 61000-4-5	3 ⁴ 2 ^{3,4}	+i/-i	2000 V _p 1000 V _p ³	1.2/50 μs	2 Ω	5 pos. and 5 neg. surges	yes	B
RF conducted immunity	IEC/EN 61000-4-6	3 2 ³	+i/-i	10 VAC 3 VAC	AM modul. 80% 1 kHz	50 Ω	0.15 to 80 MHz 150 Ω	yes	A

¹ i = input, o = output

² Performance criterion: A = normal operation, no deviation from specifications, B = temporary deviation from specs possible

³ Valid for 24IMS7 and 48IMS7

⁴ External components required

⁵ R or Trim pin open, i pin connected with Vi-

⁶ Corresponds to the railway standard EN 50121-3-2:2000, table 9.1

Electromagnetic Emissions

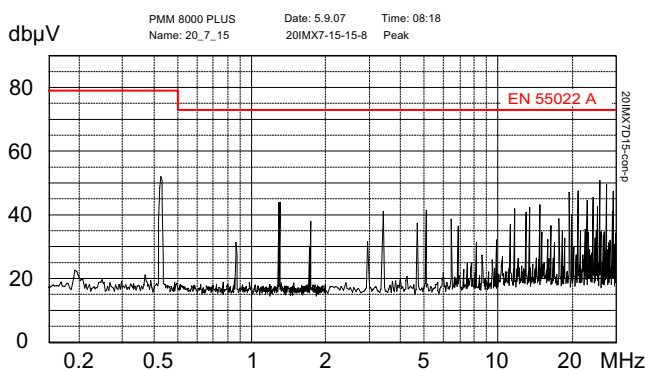

Fig. 16a

20IMX7-15-15-8: Typical conducted emissions (peak) at the input at $V_{i\text{nom}}$ and $I_{o\text{nom}}$ according to EN 55011/22. Output leads 0.1 m, twisted. External input capacitor (1 μF ceramic + 100 μF electrolytic cap)

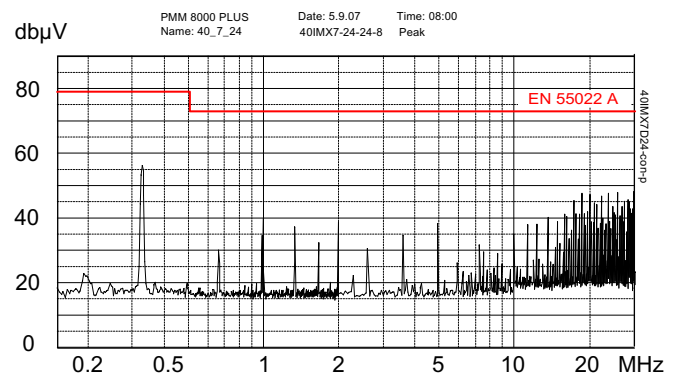

Fig. 16b

40IMX7-24-24-8: Typical conducted emissions (peak) at the input at $V_{i\text{nom}}$ and $I_{o\text{nom}}$ according to EN 55011/22. Output leads 0.1 m, twisted. External input capacitor (1 μF ceramic + 47 μF electrolytic cap)

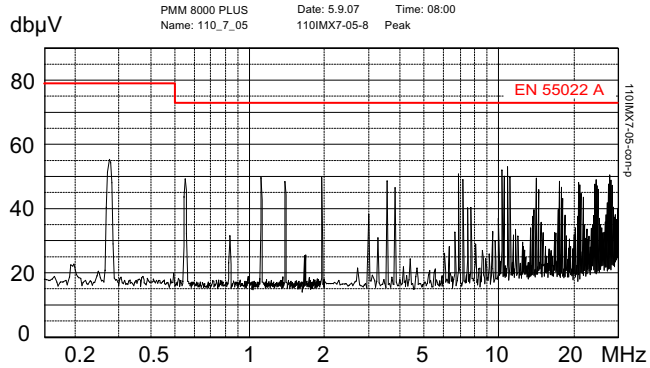

Fig. 16c
110IMX7-05-8: Typical conducted emissions (peak) at the input at $V_{i\text{nom}}$ and $I_{o\text{nom}}$ according to EN 55011/22. Output leads 0.1 m, twisted. External input capacitor (0.15 μF ceramic + 4.7 μF electrolytic cap).

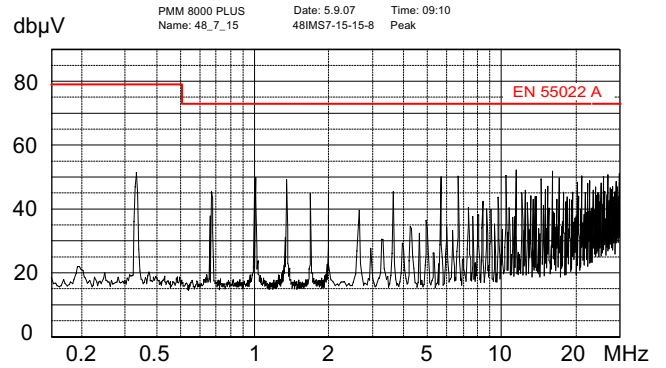

Fig. 17
48IMS7-15-15-8: Typical conducted emissions (peak) at the input at $V_{i\text{nom}}$ and $I_{o\text{nom}}$ according to EN 55011/22. Output leads 0.1 m, twisted. External input capacitor (1 μF ceramic + 47 μF electrolytic cap).

Immunity to Environmental Conditions

Table 9: Mechanical and climatic stress

Test Method		Standard	Test conditions		Status
Cab	Damp heat steady state	IEC/EN 60068-2-78 MIL-STD-810D section 507.2	Temperature: Relative humidity: Duration:	40 ± 2 °C 93 $^{+2/-3}$ % 56 days	Converter not operating
Ea	Shock (half-sinusoidal)	IEC/EN 60068-2-27 ¹ MIL-STD-810D section 516.3	Acceleration amplitude: Bump duration: Number of bumps:	100 $g_n = 981 \text{ m/s}^2$ 6 ms 18 (3 each direction)	Converter operating
Eb	Bump (half-sinusoidal)	IEC/EN 60068-2-29 MIL-STD-810D section 516.3	Acceleration amplitude: Bump duration: Number of bumps:	40 $g_n = 392 \text{ m/s}^2$ 6 ms 6000 (1000 each direction)	Converter operating
Fc	Vibration (sinusoidal)	IEC/EN 60068-2-6	Acceleration amplitude: Frequency (1 Oct/min): Test duration:	0.35 mm (10 to 60 Hz) 5 $g_n = 49 \text{ m/s}^2$ (60 to 2000 Hz) 10 to 2000 Hz 7.5 h (2.5 h each axis)	Converter operating
Fh	Vibration, broad-band random (digital control)	IEC/EN 60068-2-64	Acceleration spectral density: Frequency band: Acceleration magnitude: Test duration:	0.05 g_n^2/Hz 10 to 500 Hz 4.9 $g_{n\text{rms}}$ 3 h (1 h each axis)	Converter operating
Kb	Salt mist, cyclic (sodium chloride NaCl solution)	IEC/EN 60068-2-52	Concentration: Duration: Storage: Storage duration: Number of cycles:	5% (30 °C) 2 h per cycle 40 °C, 93% rel. humidity 22 h per cycle 3	Converter not operating

¹ Covers also EN 50155/EN 61373 category 1, class B, body mounted (= chassis of coach)

Temperatures

Table 10: Temperature specifications, valid for air pressure of 800 to 1200 hPa (800 to 1200 mbar)

Temperature			-9		-8		Unit
Characteristics	Conditions	min	max	min	max		
T_A	Ambient temperature	Operational ¹		-40	71	-40	°C
T_C	Case temperature	-40	95	-40	105		
T_S	Storage temperature	Non operational		-55	100	-55	

¹ See Thermal Considerations

Failure Rates

Table 11: MTBF and device hours

Model	Standard	Ground benign		Ground fixed		Ground mobile	Unit
		$T_C = 40\text{ }^\circ\text{C}$	$T_C = 40\text{ }^\circ\text{C}$	$T_C = 70\text{ }^\circ\text{C}$	$T_C = 50\text{ }^\circ\text{C}$		
24IMS7-05-9	MIL-HDBK-217F	634 000	321 000	188 000	271 000	h	
40IMX7-12-12-8	MIL-HDBK-217F	851 000	395 000	253 000	342 000		
	Bellcore	3 019 000	1 510 000	809 000	409 000		
40IMX7-05-05-8	Bellcore	3 320 000	1 660 000	871 000	447 000		

Mechanical Data

Dimensions in mm.
Weight: <20 g

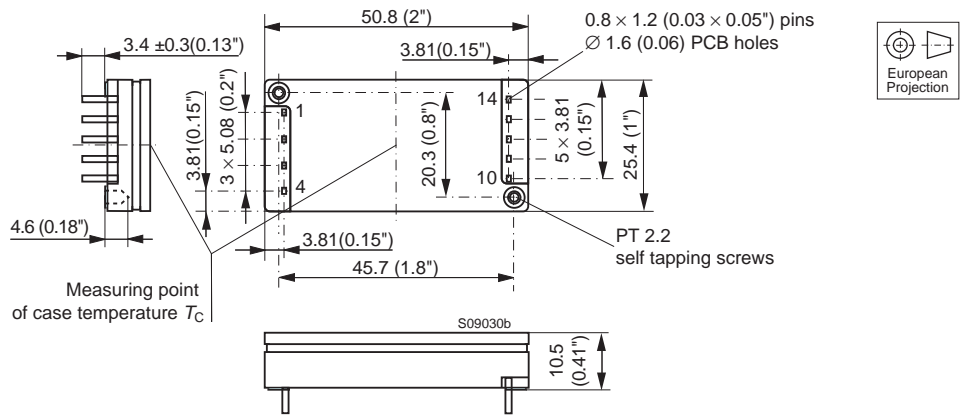

Fig. 18
Case IMX7/IMS7 with standard pinout

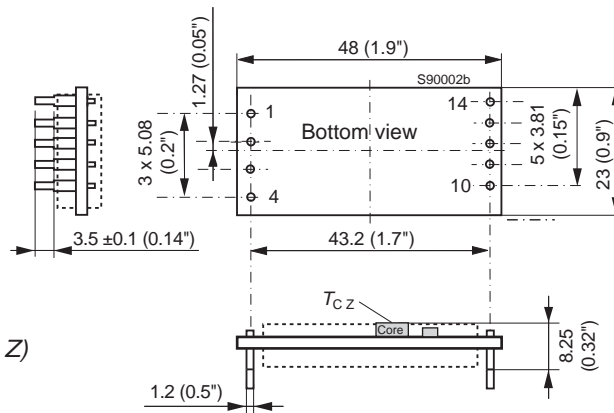

Fig. 19
Open-frame model (option Z)

Safety and Installation Instructions

Pin Allocation

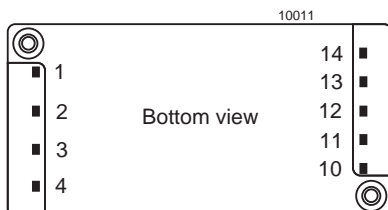

Fig. 20
Footprint

Table 12: Pin allocation (standard pinout and option Z)

Pin	Single output	Double output
1	Vi+	Vi+
2	Vi-	Vi-
3	i	i
4	n.c.	Trim
10	Vo-	Vo1-
11	Vo+	Vo1+
12	Vo-	Vo2-
13	R	Vo2+
14	n.c.	n.c.

Installation Instruction

Installation of the converters must strictly follow the national safety regulations in compliance with the enclosure, mounting, creepage, clearance, casualty, markings, and segregation requirements of the end-use application.

Connection to the system shall be made via a printed circuit board; see *Mechanical Data*.

The converters should be connected to a secondary circuit.

Do not open the converter.

Ensure that a converter failure does not result in a hazardous conditions.

To prevent excessive current flowing through the input lines in case of a short-circuit, an external fuse specified in section *Input Fuse and Reverse Polarity Protection* should be installed in the non-earthed input supply line.

Standards and Approvals

The converters are approved by UL and TÜV according to UL 60950, CAN/CSA C22.2 No. 950-95, and IEC/EN 60950:2000.

The converters have been evaluated for:

- Building in
- Supplementary insulation input to output, based on their maximum input voltage
- Pollution degree 2 environment
- Connecting the input to a secondary circuit, which is subject to a maximum transient rating of
 - 1500 V for 20IMX7, 24IMS7, 40IMX7, 48IMS7
 - 2000 V for 70IMX7
 - 2500 V for 110IMX7.

The converters are subject to manufacturing surveillance in accordance with the above mentioned standards.

Railway Applications

To comply with railway standards, all components are coated with a protective lacquer (except option Z).

Protection Degree

The protection degree of the converters is IP 30, except open-frame models (option Z).

Cleaning Agents

In order to avoid possible damage, any penetration of cleaning fluids should be prevented, since the converters are not hermetically sealed.

However, open-frame models (option Z) leave the factory unlacquered; they may be lacquered by the customer, for instance together with the mother board. Cleaning agents are not permitted. If necessary, the mother board must be cleaned before populating the open-frame converter.

Isolation

The electric strength test is performed in the factory as a routine test in accordance with EN 50116 and IEC/EN 60950, and should not be repeated in the field. Power-One will not honor any warranty claims resulting from electric strength field tests.

Table 12: Electric strength test voltages

Characteristic	Input to output			o/o ¹	Unit
	20/40IMX 24/48IMS	70IMX	110IMX		
Factory test >1 s	1.2	1.5	2.0	0.1	kVAC
Equivalent DC volt.	1.5	2.0	2.5	0.15	kVDC
Coupling capacitance	1.2	1.2	1.2	-	nF
Insulation resist. at 500 VDC	>100	>100	>100	-	MΩ

¹ Between the outputs of double-output models

Description of Options

Option Z: Open Frame

For applications, where the protection by a housing is not necessary or in the case that the motherboard should be lacquered after fitting the converter.

Note: The converters shall not be exposed to cleaning processes, as this will damage the glue of the ferrite cores.

Option G: RoHS-6

Converters with a type designation ending by G are RoHS-compliant for all six substances.

NUCLEAR AND MEDICAL APPLICATIONS - Power-One products are not designed, intended for use in, or authorized for use as critical components in life support systems, equipment used in hazardous environments, or nuclear control systems without the express written consent of the respective divisional president of Power-One, Inc.

TECHNICAL REVISIONS - The appearance of products, including safety agency certifications pictured on labels, may change depending on the date manufactured. Specifications are subject to change without notice.

EC Declaration of Conformity

We

Power-One AG
Ackerstrasse 56, CH-8610 Uster

declare under our sole responsibility that IMS/IMX7 Series DC-DC converters carrying the CE-mark are in conformity with the provisions of the Low Voltage Directive (LVD) 73/23/EEC of the European Communities.

Conformity with the directives is presumed by conformity with the following harmonised standards:

- EN 61204:1995 (= IEC 61204:1993, modified)
Low-voltage power supply devices, DC output - Performance characteristics and safety requirements
- EN 60950:2000 (= IEC 60950:2000)
Safety of information technology equipment.

The installation instructions given in the corresponding data sheet describe correct installation leading to the presumption of conformity of the end product with the LVD. All IMS/IMX7 DC-DC converters are components, intended exclusively for inclusion within other equipment by an industrial assembly operation or by professional installers. They must not be operated as standalone products.

Hence conformity with the Electromagnetic Compatibility Directive 89/336/EEC (EMC Directive) needs not to be declared. Nevertheless, guidance is provided in the data sheets on how conformity of the end product with EMC standards under the responsibility of the installer can be achieved, from which conformity with the EMC Directive can be presumed.

Uster, 10 June 2006

Power-One AG



Rolf Baldauf
Vice President Engineering



Johann Milavec
Director Projects and IP