

TLE7273-2

Low Dropout Voltage Regulator

Automotive Power



Never stop thinking



1 Overview

Features

- Output Voltage 5 V, 3.3 V or 2.6 V
- Output Voltage Tolerance $\pm 2\%$ Up To 180mA
- Ultra Low Quiescent Current Consumption $< 36 \mu\text{A}$
- Enable Function
- Very Low Dropout Voltage
- Reset With Adjustable Power-On delay
- Window Watchdog With Current Dependent Deactivation
- Output Current Limitation
- Wide Operation Range Up To 45 V
- Wide Temperature Range From $-40 \text{ }^\circ\text{C}$ To $150 \text{ }^\circ\text{C}$
- Overtemperature Shutdown
- Green Product (RoHS compliant)
- AEC Qualified

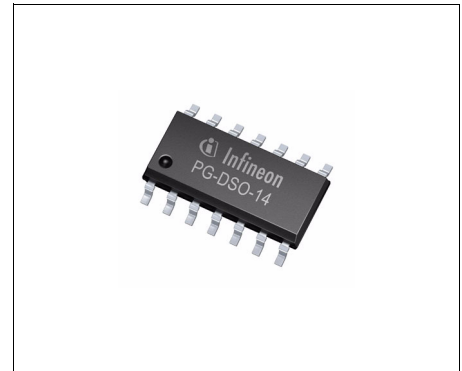

PG-DSO-14

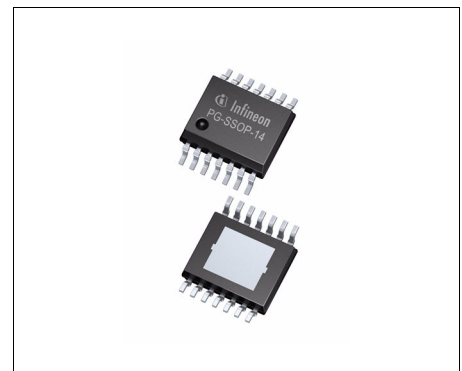

PG-SSOP-14 Exposed Pad

Description

The TLE7273-2 is a monolithic voltage regulator with integrated window watchdog and reset dedicated for microcontroller supplies under harsh automotive environment conditions.

Due to its ultra low quiescent current, the TLE7273-2 is perfectly suited for applications that are permanently connected to battery. In addition, the regulator can be shut down via the Enable input causing the current consumption to drop below $3 \mu\text{A}$. The TLE7273-2 is equipped with an output current limitation and an overtemperature shutdown, protecting the device against overload, short circuit and over-temperature. It operates in the wide junction temperature range from $-40 \text{ }^\circ\text{C}$ to $150 \text{ }^\circ\text{C}$.

Type	Package	Marking
TLE7273-2GV50	PG-DSO-14	TLE7273-2GV50
TLE7273-2GV33	PG-DSO-14	TLE7273-2GV33
TLE7273-2GV26	PG-DSO-14	TLE7273-2GV26
TLE7273-2EV50	PG-SSOP-14 Exposed Pad	7273 V50

2 Block Diagram

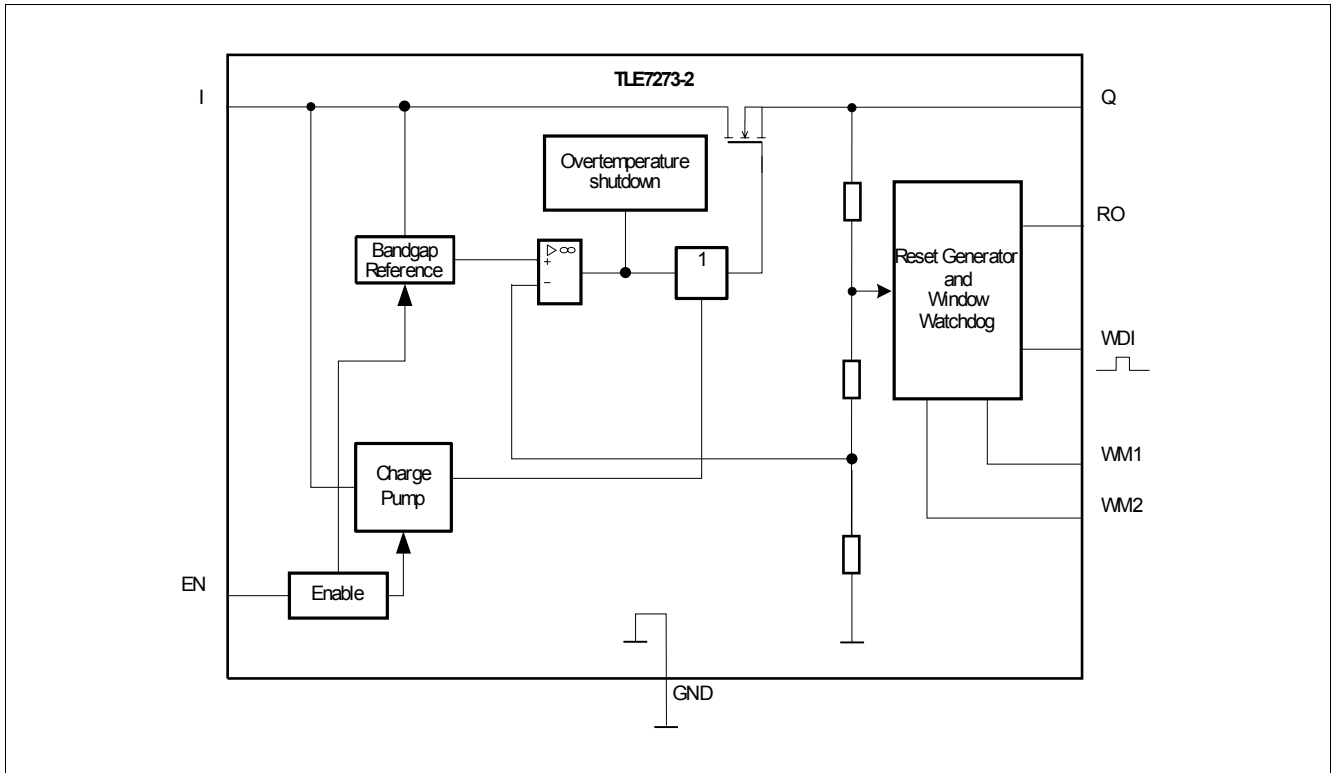

Figure 1 Block Diagram

3 Pin Configuration

3.1 Pin Assignment (PG-DSO-14)

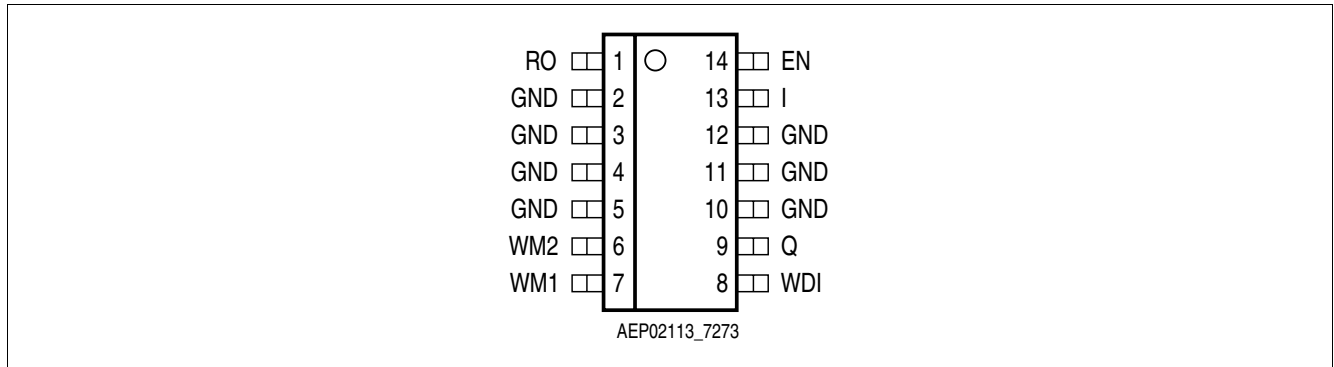

Figure 2 Pin Assignment PG-DSO-14 (top view)

3.2 Pin Definitions and Functions (PG-DSO-14)

Table 1 Pin Definitions and Functions

Pin No.	Symbol	Function
1	RO	Reset Output TLE7273-2GV33, TLE7273-2GV26: open drain output; TLE7273-2GV50: integrated 20 kΩ pull-up resistor to output Q; leave open if not needed
2-5, 10-12	GND	Ground connect pin 2 and 3 to GND; connect pin 4-5 and 10-12 to heat sink area with GND potential
7	WM1	Watchdog Mode Bit 1 watchdog and reset mode selection, see “Window Watchdog State Diagram, Watchdog and Reset Modes” on Page 9 ; connect to Q or GND
6	WM2	Watchdog Mode Bit 2 watchdog and reset mode selection, see “Window Watchdog State Diagram, Watchdog and Reset Modes” on Page 9 ; connect to Q or GND
8	WDI	Watchdog Input trigger input for watchdog pulses; to turn off watchdog connect to GND and connect pin WM1 and WM2 to Q
9	Q	Output Voltage block to GND with a ceramic capacitor close to the IC terminals, respecting the values given for its capacitance and ESR in “Functional Range” on Page 7
13	I	Input Voltage block to ground directly at the IC with a 100 nF ceramic capacitor
14	EN	Enable Input low level disables the IC; integrated pull-down resistor to GND

3.3 Pin Assignments (PG-SSOP-14 Exposed Pad)

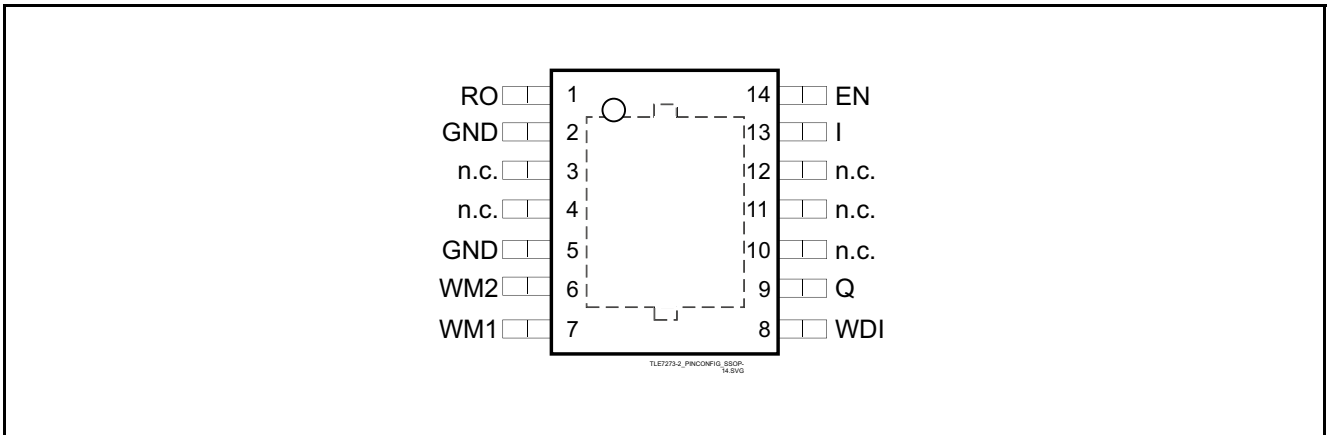

Figure 3 Pin Assignment PG-SSOP-14 Exposed Pad (top view)

3.4 Pin Definitions and Functions (PG-SSOP-14 Exposed Pad)

Table 2 Pin Definitions and Functions

Pin No.	Symbol	Function
1	RO	Reset Output integrated 20 kΩ pull-up resistor (TLE7273-2EV50); leave open if not needed
2, 5	GND	Ground connect to GND
3, 4, 10, 11, 12	n.c.	not connected leave open or connect to GND
6	WM2	Watchdog Mode Bit 2 watchdog and reset mode selection, see Figure 5 ; connect to V_Q or GND
7	WM1	Watchdog Mode Bit 1 watchdog and reset mode selection, see Figure 5 ; connect to V_Q or GND
8	WDI	Watchdog Input trigger input for watchdog pulses; pull down to GND if not needed and turn off the watchdog with WM1 and WM2 pin
9	Q	Output Voltage block to GND with a ceramic capacitor $C_Q \geq 470$ nF close to IC terminal
13	I	Input Voltage block to ground directly at the IC with a 100 nF ceramic capacitor
14	EN	Enable Input low level disables the IC; integrated pull-down resistor
Pad	–	Exposed Pad connect to heatsink area; connect with GND on PCB

4 General Product Characteristics

4.1 Absolute Maximum Ratings

Table 3 Absolute Maximum Ratings¹⁾
 $-40\text{ °C} < T_j < 150\text{ °C}$

Pos.	Parameter	Symbol	Limit Values		Unit	Remarks
			Min.	Max.		
Input I						
4.1.1	Voltage	V_I	-0.3	45	V	–
Output Q, Reset Output RO, Watchdog Mode 2						
4.1.2	Voltage	V_Q	-0.3	5.5	V	permanent
4.1.3	Voltage	V_Q	-0.3	6.2	V	$t < 10\text{ s}^2)$
Enable Input EN						
4.1.4	Voltage	V_{EN}	-1	45	V	–
4.1.5	Current	I_{EN}	-1	1	mA	–
Watchdog Input WDI						
4.1.6	Voltage	V_{RO}	-1	7	V	permanent
Watchdog Mode 1						
4.1.7	Voltage	V_{WM1}	-0.3	5.5	V	permanent
4.1.8	Voltage	V_{WM1}	-0.3	6.2	V	$t < 10\text{ s}^2)$
4.1.9	Current	I_{WM1}	-5	5	mA	–
ESD Susceptibility						
4.1.10	Human Body Model (HBM) ³⁾	Voltage	-	3	kV	–
4.1.11	Charged Device Model (CDM) ⁴⁾	Voltage	-	1.5	kV	–
Temperatures						
4.1.12	Junction Temperature	T_j	-40	150	°C	–
4.1.13	Storage Temperature	T_{stg}	-50	150	°C	–

1) not subject to production test, specified by design

2) exposure to these absolute maximum ratings for extended periods ($t > 10\text{ s}$) may affect device reliability

3) ESD HBM Test according JEDEC JESD22-A114

4) ESD CDM Test according AEC/ESDA ESD-STM5.3.1-1999

Note: Maximum ratings are absolute ratings; exceeding any one of these values may cause irreversible damage to the integrated circuit. Integrated protection functions are designed to prevent IC destruction under fault conditions. Fault conditions are considered as outside normal operating range. Protection functions are not designed for continuous repetitive operation.

4.2 Functional Range

Pos.	Parameter	Symbol	Limit Values		Unit	Remarks
			Min.	Max.		
4.2.1	Input Voltage	V_I	5.5	45	V	TLE7273-2GV50, TLE7273-2EV50
4.2.2			4.2	45	V	TLE7273-2GV33
4.2.3			4.5	45	V	TLE7273-2GV26
4.2.4	Output Capacitor's Requirements for Stability	C_Q	470	–	nF	– ¹⁾
4.2.5		$ESR(C_Q)$	–	3	Ω	– ²⁾

1) the minimum output capacitance requirement is applicable for a worst case capacitance tolerance of 30%

2) relevant ESR value at $f = 10$ kHz

Note: Within the functional range the IC operates as described in the circuit description. The electrical characteristics are specified within the conditions given in the related electrical characteristics table.

4.3 Thermal Resistances

Pos.	Parameter	Symbol	Limit Values			Unit	Remarks
			Min.	Typ.	Max.		
Package PG-DSO-14							
4.3.1	Junction to Soldering Point ¹⁾	R_{thJSP}	–	30	–	K/W	measured to group of pins 3, 4, 5, 10, 11, 12
4.3.2	Junction to Ambient ¹⁾	R_{thJA}	–	53	–	K/W	²⁾
4.3.3			–	105	–	K/W	footprint only ³⁾
4.3.4			–	74	–	K/W	300 mm ² heatsink area on PCB ³⁾
4.3.5			–	65	–	K/W	600 mm ² heatsink area on PCB ³⁾
Package PG-SSOP-14 Exposed Pad							
4.3.6	Junction to Case ¹⁾	R_{thJSP}	–	14	–	K/W	measured to exposed pad
4.3.7	Junction to Ambient ¹⁾	R_{thJA}	–	47	–	K/W	²⁾
4.3.8			–	141	–	K/W	footprint only ³⁾
4.3.9			–	66	–	K/W	300 mm ² heatsink area on PCB ³⁾
4.3.10			–	56	–	K/W	600 mm ² heatsink area on PCB ³⁾

1) not subject to production test, specified by design

2) Specified R_{thJA} value is according to Jedec JESD51-2,-5,-7 at natural convection on FR4 2s2p board; The Product (Chip+Package) was simulated on a 76.2 x 114.3 x 1.5 mm³ board with 2 inner copper layers (2 x 70 μ m Cu, 2 x 35 μ m Cu). Where applicable a thermal via array under the exposed pad contacted the first inner copper layer.

3) Specified R_{thJA} value is according to JEDEC JESD 51-3 at natural convection on FR4 1s0p board; The Product (Chip+Package) was simulated on a 76.2 x 114.3 x 1.5 mm³ board with 1 copper layer (1 x 70 μ m Cu).

5 Block Description and Electrical Characteristics

5.1 Description

5.1.1 Power On Reset and Reset Output

For an output voltage level of $V_Q \geq 1\text{ V}$, the reset output is held low. When the level of V_Q reaches the reset threshold V_{RT} , the signal at RO remains low for the power-up reset delay time t_{RD} . The reset function and timing is illustrated in **Figure 4**. The reset reaction time t_{RR} avoids wrong triggering caused by short “glitches” on the V_Q -line. In case of V_Q power down ($V_Q < V_{RT}$ for $t > t_{RR}$) a logic low signal is generated at the pin RO to reset an external microcontroller.

The TLE7273-2GV50 and TLE7273-2EV50 feature an integrated pull-up resistor on the reset output while the TLE7273-2GV33 and TLE7273-2GV26 have an open drain output requiring an external pull-up resistor. When connected to a voltage level of 5 V, a recommended value for this external resistor is $\geq 5.6\text{ k}\Omega$.

But it's also possible calculating its value by using the following formula, based on the reset sink current (Example: external pull-up resistor connected to $V_{ext} = 5\text{ V}$):

$$R_{\text{extmin}} = \Delta V / I_{RO} = (V_{\text{ext}} - V_{RO\text{min}}) / I_{RO} = (5\text{ V} - 0.25\text{ V}) / 1.0\text{ mA} = 4.75\text{ k}\Omega$$

At low output voltage levels $V_Q < 1\text{ V}$ the integrated pull-up resistor of the TLE7273-2GV50 is switched off setting the reset output high ohmic.

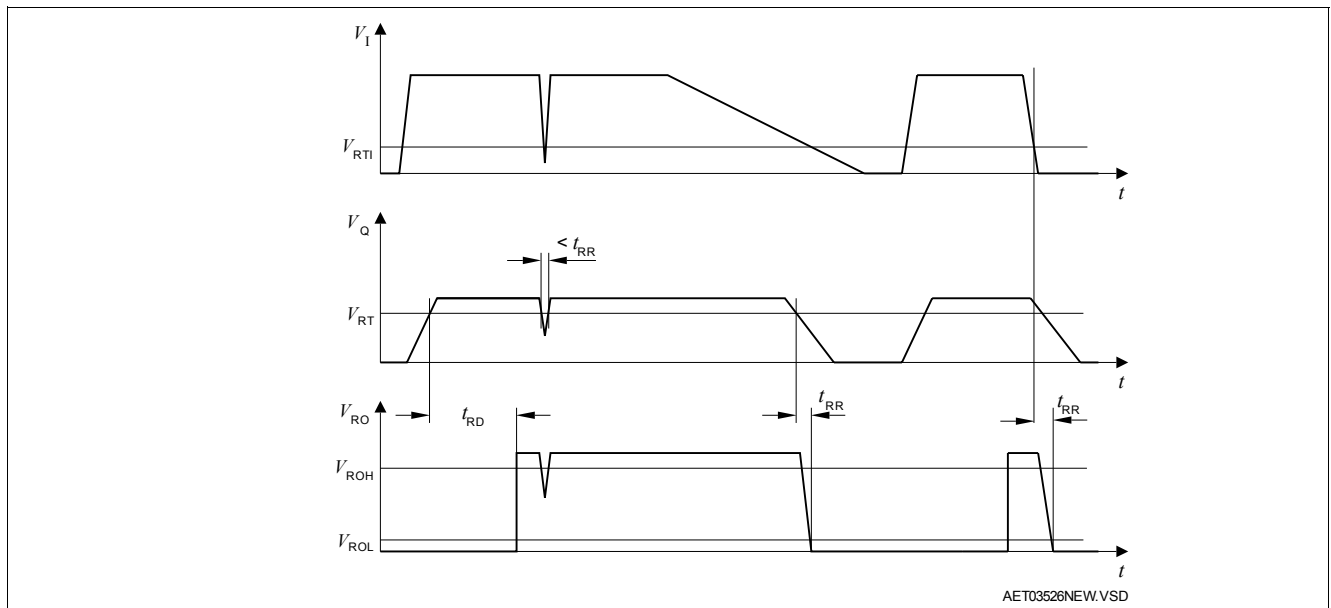

Figure 4 Reset Function and Timing Diagram

5.1.2 Watchdog Operation

The watchdog uses a fraction of the charge pump oscillator's clock signal as timebase. The watchdog timebase can be adjusted using the pins WM1 and WM2 (see **Figure 5**). The watchdog can be turned off setting WM1 and WM2 to high level. The timing values refer to typ. values with WM1 and WM2 connected to GND (fast watchdog and reset timing).

Figure 5 shows the state diagram of the window watchdog (WWD) and the watchdog and reset mode selection. After power-on, the reset output signal at the RO pin (microcontroller reset) is kept LOW for the reset delay time t_{RD} of typ. 16 ms. With the LOW to HIGH transition of the signal at RO the device starts the ignore window time t_{CW} (32 ms). During this window the signal at the WDI pin is ignored. Next the WWD starts the open window which

Block Description and Electrical Characteristics

is in the very first turn after power up a long open window with $t_{max} = 4 * t_{OW}$. In the following turns, the timing corresponds to the standard timing setting as described in the specification.

When a valid trigger signal is detected during the open window a closed window is initialized immediately. A trigger signal within the closed window is interpreted as a pretrigger failure and results in a reset. After the closed window the open window with the duration t_{OW} is started again. The open window lasts at minimum until the trigger process has occurred, at maximum t_{OW} is 32 ms (typ. value with fast timing).

A HIGH to LOW transition of the watchdog trigger signal at pin WDI is considered as a valid trigger pulse.

See **Figure 7**: To avoid wrong triggering due to parasitic glitches two HIGH samples followed by two LOW samples (sample period t_{sam} typ. 0.5 ms) are decoded as a valid trigger .

A reset is generated (RO goes LOW) if there is no trigger pulse during the open window or if a pretrigger occurs during the closed window. The triggering is correct also, if the first three samples (two HIGH one LOW) of the trigger pulse at pin WDI are inside the closed window and only the fourth sample (the second LOW sample) is taken in the open window.

After turning OFF the Watchdog by output current reduction, RO remains high. (see also the signal diagram in **Figure 6**). After turning ON the WWD again by exceeding the current threshold, the logic cycle starts again with the Ignore Window and goes then into the "1st. long open window". This 1st long OW is maximum $4 * t_{OW}$ long and allows the re-synchronisation between the micro controller and the WWD timing. The 1st. long OW is closed by the first valid trigger on WDI from the micro controller. This trigger ensures the synchronisation. As soon as this trigger is done, the micro controller timing must be stable and correspondent to t_{WD} .

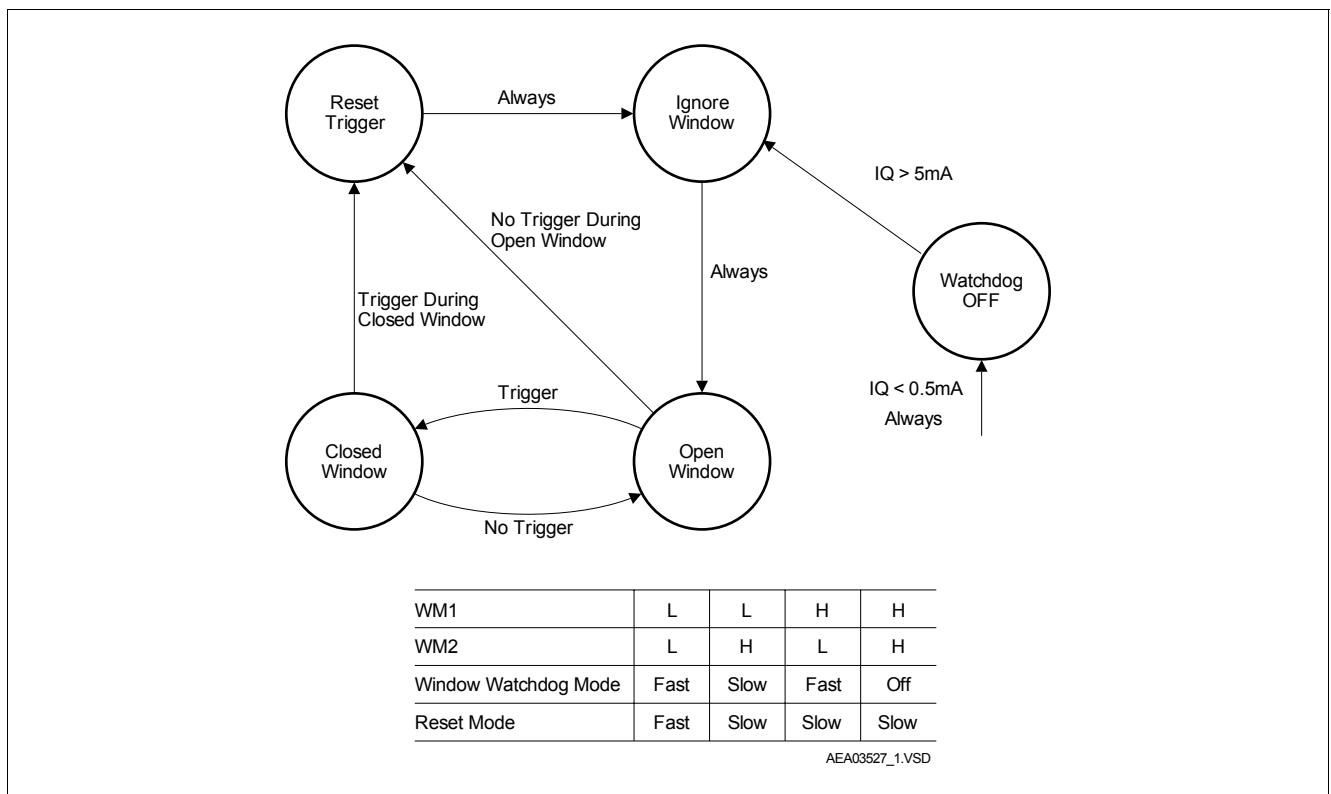

Figure 5 Window Watchdog State Diagram, Watchdog and Reset Modes

Block Description and Electrical Characteristics

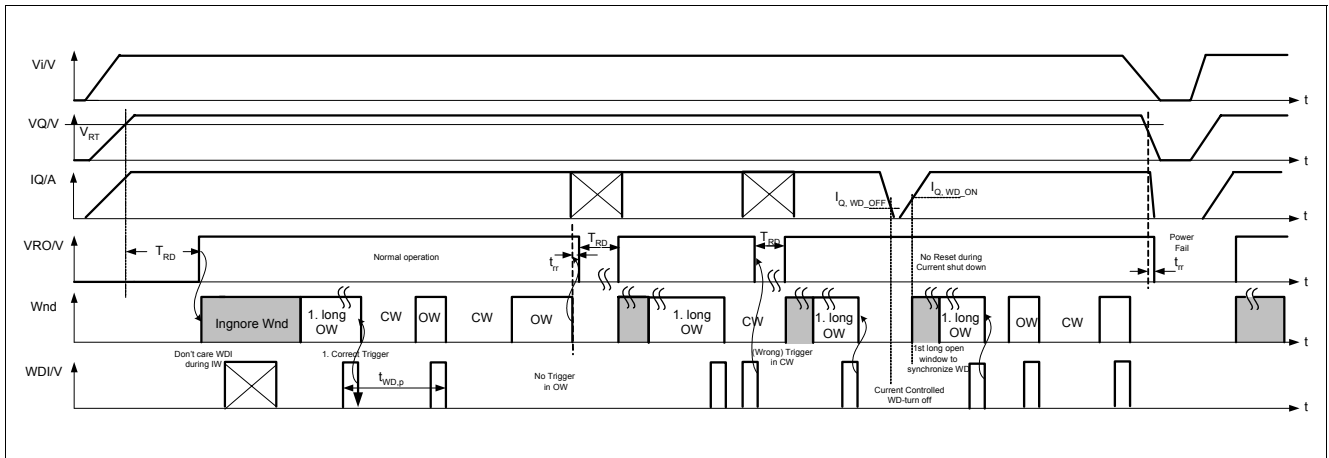

Figure 6 Window Watchdog Signal Diagram

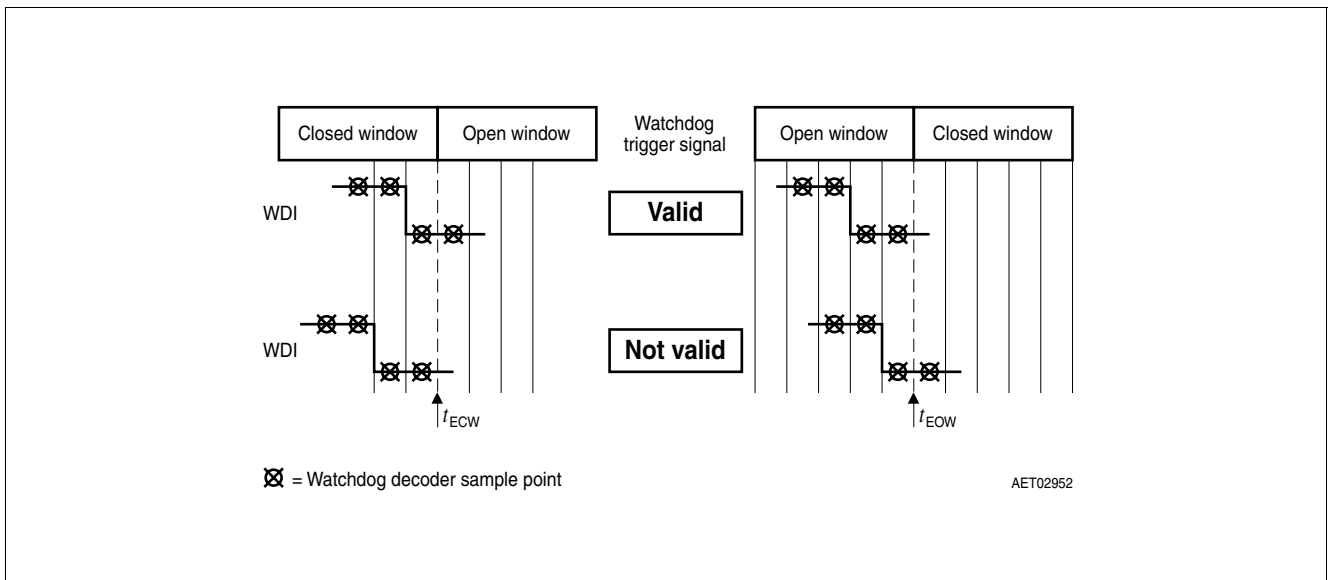

Figure 7 Window Watchdog Definitions

5.2 Electrical Characteristics

Electrical Characteristics

 $V_I = 13.5 \text{ V}; -40 \text{ }^\circ\text{C} < T_j < 150 \text{ }^\circ\text{C};$ unless otherwise specified

Pos.	Parameter	Symbol	Limit Values			Unit	Test Condition
			Min.	Typ.	Max.		
Output Q							
5.2.1	Output Voltage	V_Q	4.90	5.00	5.10	V	TLE7273-2GV50, TLE7273-2EV50 $1 \text{ mA} < I_Q < 180 \text{ mA}$ $6 \text{ V} < V_I < 16 \text{ V}$
5.2.2	Output Voltage	V_Q	4.90	5.00	5.10	V	TLE7273-2GV50, TLE7273-2EV50 $I_Q = 10 \text{ mA}$ $6 \text{ V} < V_I < 45 \text{ V}$
5.2.3	Output Voltage	V_Q	3.234	3.30	3.366	V	TLE7273-2GV33 $1 \text{ mA} < I_Q < 180 \text{ mA}$ $4.5 \text{ V} < V_I < 16 \text{ V}$
5.2.4	Output Voltage	V_Q	3.234	3.30	3.366	V	TLE7273-2GV33 $I_Q = 10 \text{ mA}$ $4.5 \text{ V} < V_I < 45 \text{ V}$
5.2.5	Output Voltage	V_Q	2.548	2.60	2.652	V	TLE7273-2GV26 $1 \text{ mA} < I_Q < 180 \text{ mA}$ $4.5 \text{ V} < V_I < 16 \text{ V}$
5.2.6	Output Voltage	V_Q	2.548	2.60	2.652	V	TLE7273-2GV26 $I_Q = 10 \text{ mA}$ $4.5 \text{ V} < V_I < 45 \text{ V}$
5.2.7	Output Current Limitation	I_Q	200	–	500	mA	$V_Q = 2.0 \text{ V}$
5.2.8			200	–	600		$V_Q = 0 \text{ V}$
5.2.9	Dropout Voltage ¹⁾ $V_{DR} = V_I - V_Q$	V_{DR}	–	250	500	mV	$I_Q = 180 \text{ mA}$ TLE7273-2GV50, TLE7273-2EV50
5.2.10	Load Regulation	$\Delta V_{Q,Lo}$	–	50	90	mV	$1 \text{ mA} < I_Q < 180 \text{ mA};$
5.2.11	Line Regulation	$\Delta V_{Q,Li}$	–	10	50	mV	$I_Q = 1 \text{ mA};$ $10 \text{ V} < V_I < 32 \text{ V}$
5.2.12	Power Supply Ripple Rejection	$PSRR$	–	60	–	dB	$f_r = 100 \text{ Hz};$ $V_r = 0.5 V_{PP}$
5.2.13	Reverse Output Current Clamping	V_Q	–	–	5.5	V	$I_Q = -1 \text{ mA},$ $V_{EN} = 0 \text{ V}$
Current Consumption							
5.2.14	Quiescent Current $I_q = I_I - I_Q$	I_q	–	28	36	μA	$I_Q = 100 \mu\text{A};$ $T_j < 80^\circ\text{C}$
5.2.15	Quiescent Current Disabled	I_q	–	1	3	μA	$V_{EN} = 0\text{V};$ $T_j < 80^\circ\text{C}$
Enable Input EN							
5.2.16	High Level Input Voltage	$V_{EN,H}$	3.0	–	–	V	V_Q on

Block Description and Electrical Characteristics
Electrical Characteristics
 $V_I = 13.5 \text{ V}$; $-40 \text{ }^\circ\text{C} < T_j < 150 \text{ }^\circ\text{C}$; unless otherwise specified

Pos.	Parameter	Symbol	Limit Values			Unit	Test Condition
			Min.	Typ.	Max.		
5.2.17	Low Level Input Voltage	$V_{EN,L}$	–	–	0.5	V	$V_Q = 0.02 \text{ V}$; $I_Q = 5 \text{ mA}$; $T_j < 125 \text{ }^\circ\text{C}$
5.2.18			–	–	0.3	V	$V_Q = 0.02 \text{ V}$; $I_Q = 5 \text{ mA}$
5.2.19	High Level Input Current	$I_{EN,H}$	–	3	4	μA	$V_{EN} = 5 \text{ V}$

Watchdog Mode Bit 1

5.2.20	High Level Input Voltage	$V_{WM1,H}$	4.00	–	–	V	TLE7273-2GV50, TLE7273-2EV50
5.2.21			2.65	–	–	V	TLE7273-2GV33
5.2.22			2.30	–	–	V	TLE7273-2GV26
5.2.23	Low Level Input Voltage	$V_{WM1,L}$	–	–	0.80	V	

Watchdog Mode Bit 2

5.2.24	High Level Input Voltage	$V_{WM2,H}$	4.00	–	–	V	TLE7273-2GV50, TLE7273-2EV50
5.2.25			2.65	–	–	V	TLE7273-2GV33
5.2.26			2.30	–	–	V	TLE7273-2GV26
5.2.27	Low Level Input Voltage	$V_{WM2,L}$	–	–	0.80	V	

Watchdog Input WDI

5.2.28	High Level Input Voltage	$V_{WDI,H}$	4.00	–	–	V	TLE7273-2GV50, TLE7273-2EV50
5.2.29			2.65	–	–	V	TLE7273-2GV33
5.2.30			2.30	–	–	V	TLE7273-2GV26
5.2.31	Low Level Input Voltage	$V_{WDI,L}$	–	–	0.80	V	
5.2.32	High Level Input Current	$I_{WDI,H}$	–	3	4	μA	$V_{WDI} = 5 \text{ V}$
5.2.33	Low Level Input Current	$I_{WD,I,L}$	–	0.5	1	μA	$V_{WDI} = 0 \text{ V}$ $T_j < 80 \text{ }^\circ\text{C}$
5.2.34	Watchdog Sampling Time	t_{sam}	0.40	0.50	0.60	ms	Fast Watchdog Timing
5.2.35			0.80	1.00	1.20	ms	Slow Watchdog Timing
5.2.36	Ignore Window Time	t_{IW}	25.6	32.0	38.4	ms	Fast Watchdog Timing
5.2.37			51.2	64.0	76.8	ms	Slow Watchdog Timing
5.2.38	Open Window Time	t_{OW}	25.6	32.0	38.4	ms	Fast Watchdog Timing
5.2.39			51.2	64.0	76.8	ms	Slow Watchdog Timing
5.2.40	Closed Window Time	t_{CW}	25.6	32.0	38.4	ms	Fast Watchdog Timing
5.2.41			51.2	64.0	76.8	ms	Slow Watchdog Timing
5.2.42	Window Watchdog Trigger Time ²⁾	t_{WD}	–	48	–	ms	Fast Watchdog Timing
5.2.43			–	96	–	ms	Slow Watchdog Timing

Block Description and Electrical Characteristics
Electrical Characteristics
 $V_I = 13.5 \text{ V}; -40 \text{ }^\circ\text{C} < T_j < 150 \text{ }^\circ\text{C};$ unless otherwise specified

Pos.	Parameter	Symbol	Limit Values			Unit	Test Condition
			Min.	Typ.	Max.		
5.2.44	Watchdog Deactivation Current Threshold	I_{Q,WD_off}	0.50	–	–	mA	I_Q decreasing $V_I > 5.5\text{V}$ for TLE7273-2GV50, TLE7273-2EV50 $V_I > 4.5\text{V}$ for TLE7273- 2GV33, TLE7273-2GV26
5.2.45	Watchdog Activating Current Threshold	I_{Q,WD_on}	–	–	5	mA	I_Q increasing $V_I > 5.5\text{V}$ for TLE7273-2GV50, TLE7273-2EV50 $V_I > 4.5\text{V}$ for TLE7273- 2GV33, TLE7273-2GV26

Reset Output RO

5.2.46	Output Undervoltage Reset Switching Threshold	V_{RT}	4.50	4.60	4.70	V	TLE7273-2GV50, TLE7273-2EV50 V_Q decreasing
5.2.47			3.00	3.07	3.13	V	TLE7273-2GV33 ³⁾ $V_I > 4.5\text{V};$ V_Q decreasing
5.2.48			2.35	2.38	2.45	V	TLE7273-2GV26 ³⁾ $V_I > 4.5\text{V};$ V_Q decreasing
5.2.49	Input Undervoltage Reset Switching Threshold	V_{RTI}	–	3.9	4.0	V	TLE7273-2GV26 ³⁾ TLE7273-2GV33 ³⁾ $V_Q > V_{RT};$ V_I decreasing
5.2.50							
5.2.51							
5.2.52	Output Undervoltage Reset Hysteresis	V_{RH}	–	45	–	mV	TLE7273-2GV26
5.2.53	Output Undervoltage Reset Hysteresis	V_{RH}	–	60	–	mV	TLE7273-2GV33
5.2.54			–	90	–	mV	TLE7273-2GV50, TLE7273-2EV50
5.2.55	Maximum Reset Sink Current	$I_{RO,max}$	1.75	–	–	mA	TLE7273-2GV50, TLE7273-2EV50 $V_Q = 4.5 \text{ V};$ $V_{RO} = 0.25 \text{ V}$
5.2.56			1.3	–	–	mA	TLE7273-2GV33 $V_Q = 3.0 \text{ V};$ $V_{RO} = 0.25 \text{ V}$
5.2.57			1.0	–	–	mA	TLE7273-2GV26 $V_Q = 2.35\text{V};$ $V_{RO} = 0.25\text{V}$

Block Description and Electrical Characteristics
Electrical Characteristics
 $V_I = 13.5 \text{ V}; -40 \text{ }^\circ\text{C} < T_j < 150 \text{ }^\circ\text{C};$ unless otherwise specified

Pos.	Parameter	Symbol	Limit Values			Unit	Test Condition
			Min.	Typ.	Max.		
5.2.58	Reset Output Low Level Voltage	V_{ROL}	–	0.15	0.25	V	$V_Q \geq 1 \text{ V};$ $I_{RO} < 200 \text{ } \mu\text{A}$
5.2.59	Reset Output High Level Voltage	V_{ROH}	4.5	–	–	V	TLE7273-2GV50, TLE7273-2EV50
5.2.60	Reset High Level Leakage Current	I_{ROLK}	–	–	1	μA	TLE7273-2GV33 TLE7273-2GV26
5.2.61	Integrated Reset Pull Up Resistor	R_{RO}	10	20	40	k Ω	TLE7273-2GV50, TLE7273-2EV50 internally connected to V_Q
5.2.62	Power-On Reset Delay Time	t_{RD}	12.8	16.0	19.2	ms	Fast Reset Timing
5.2.63			25.6	32.0	38.4	ms	Slow Reset Timing
5.2.64	Reset Reaction Time	t_{RR}	–	4	12	μs	

- 1) measured when the output voltage has dropped 100 mV from the nominal value obtained at $V_I = 13.5 \text{ V}$
- 2) recommendation for typical trigger time; $t_{WD} = t_{CW} + 1/2 * t_{OW}$
- 3) reset output triggered when output voltage V_Q is lower than output voltage reset switching threshold V_{RT} or is also triggered, when input voltage is decreasing to $V_I < 4.0 \text{ V}$ and $V_Q > V_{RT}$

Typical Performance Characteristics

Current Consumption I_q versus Junction Temperature T_j (EN=ON)

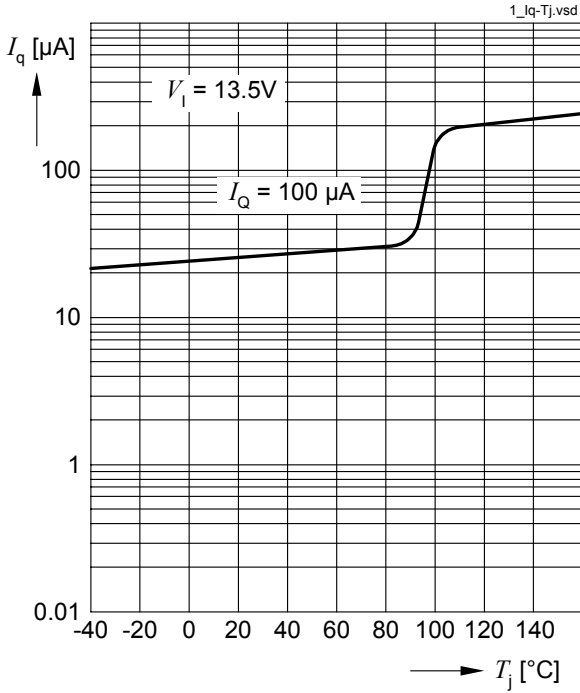

Current Consumption I_q versus Output Current I_Q (EN=ON)

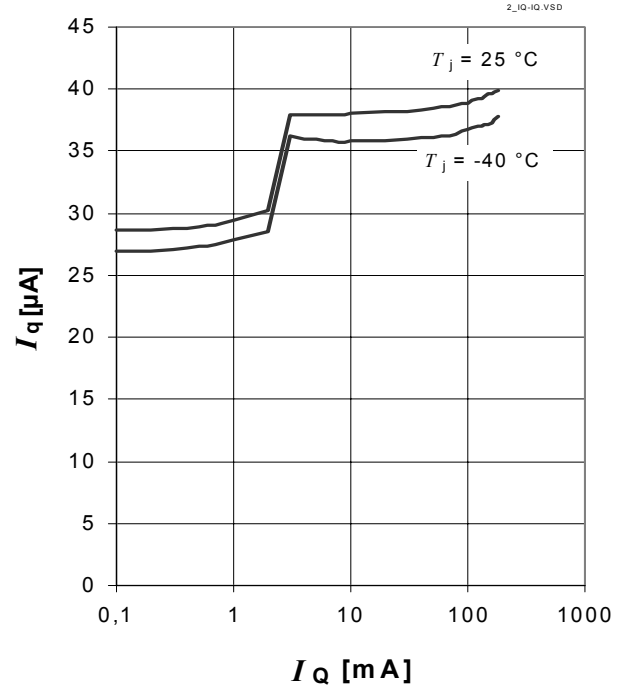

Current Consumption I_q versus Input Voltage V_i at $T_j=25^\circ\text{C}$ (EN=ON)

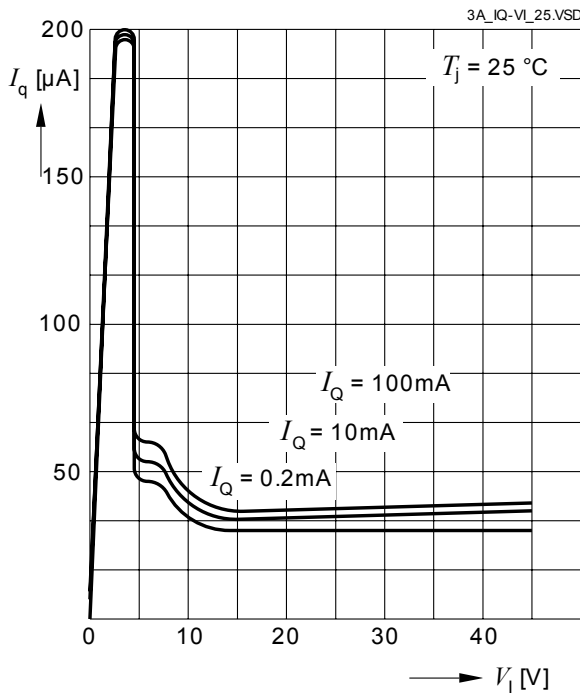

Current Consumption I_q versus Input Voltage V_i at $T_j=-40^\circ\text{C}$ (EN=ON)

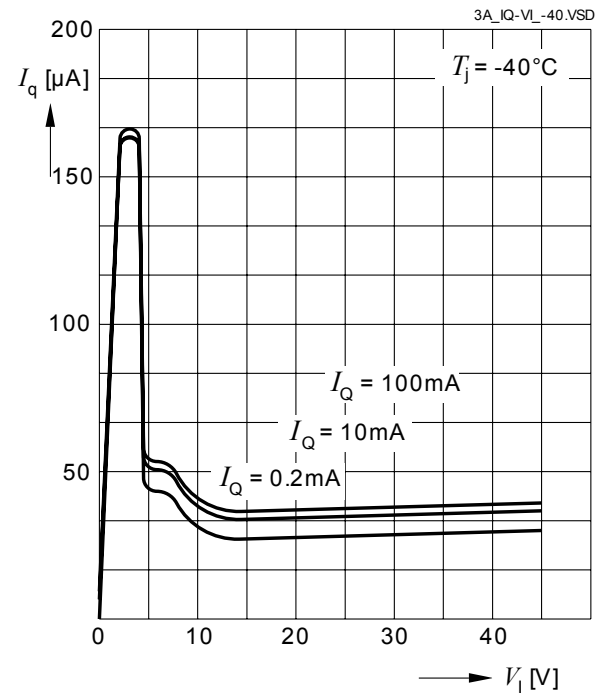

Typical Performance Characteristics (cont'd)

Load Regulation dV_Q versus Output Current Change dI_Q

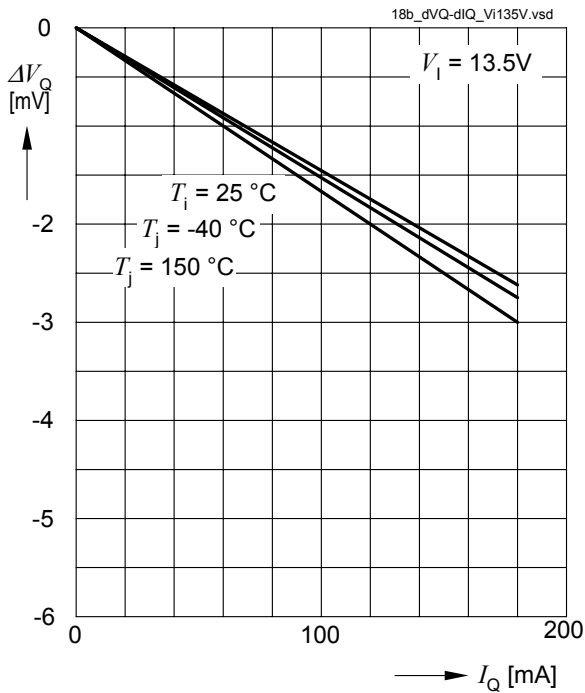

Load Regulation dV_Q versus Output Current Change dI_Q

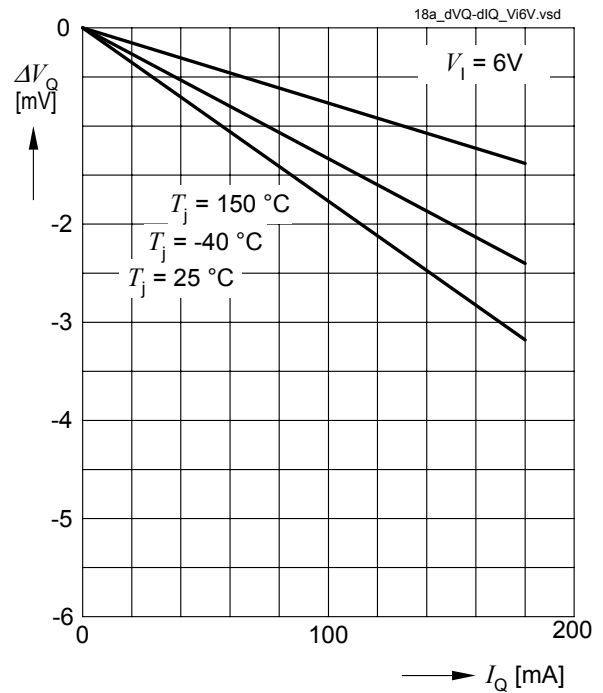

Power Supply Ripple Rejection $PSRR$

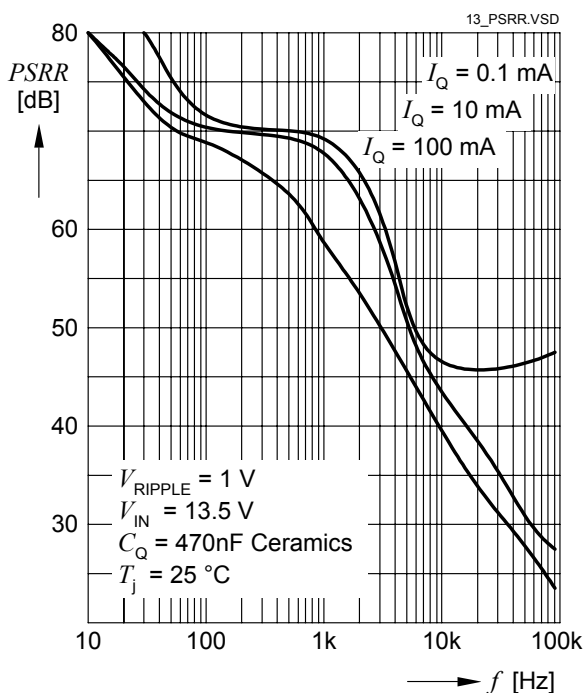

Load Regulation dV_Q versus Output Current Change dI_Q

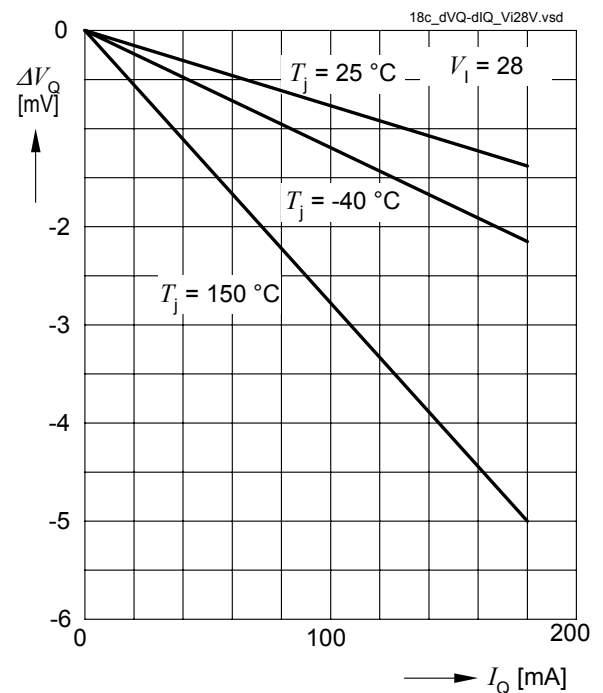

Typical Performance Characteristics (cont'd)

Line Regulation dV_Q versus Input Voltage Change dV_I

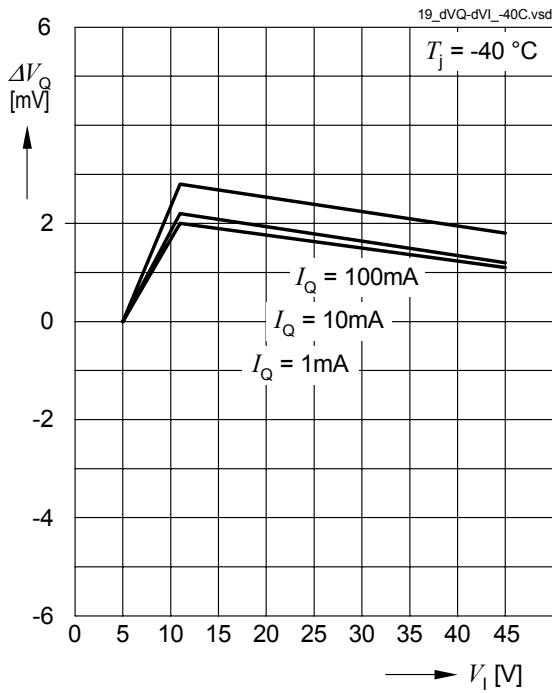

Line Regulation dV_Q versus Input Voltage Change dV_I

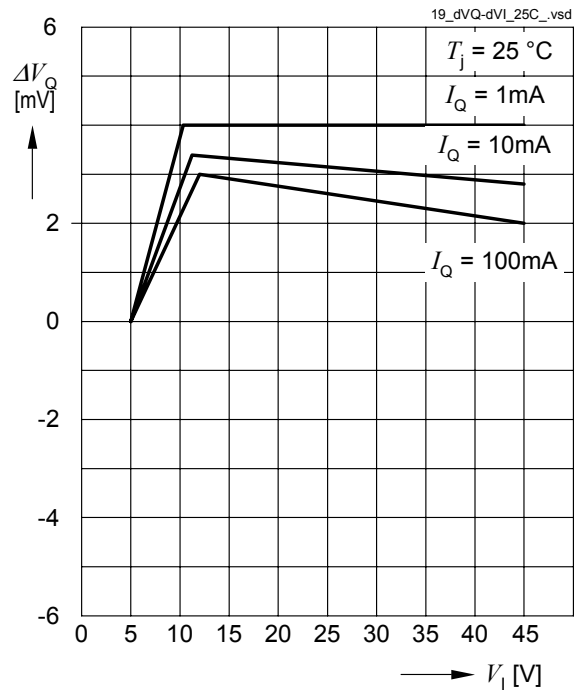

Line Regulation dV_Q versus Input Voltage Change dV_I

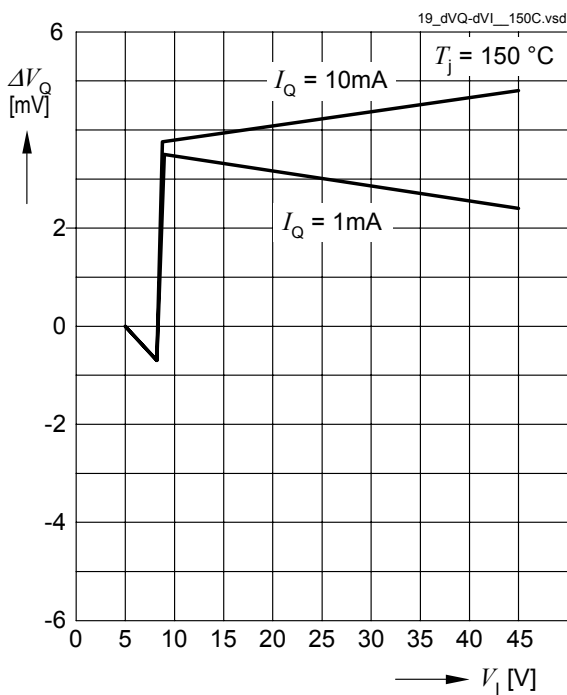

Enable Input Current I_{EN} versus Enable Input Voltage V_{EN}

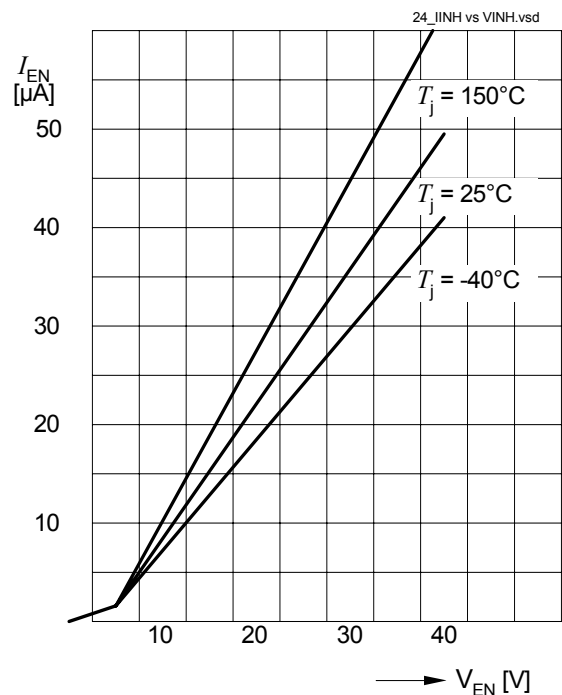

Typical Performance Characteristics (cont'd)

Enable Input Current I_{EN} versus Input Voltage V_I , EN=Off

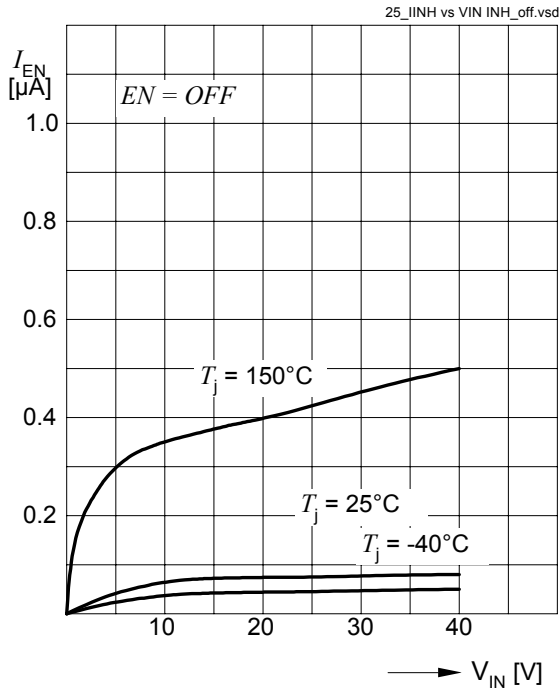

Enable High Level / Low Level Input Voltage $V_{EN,H} / V_{EN,L}$ versus Junction Temperature T_j

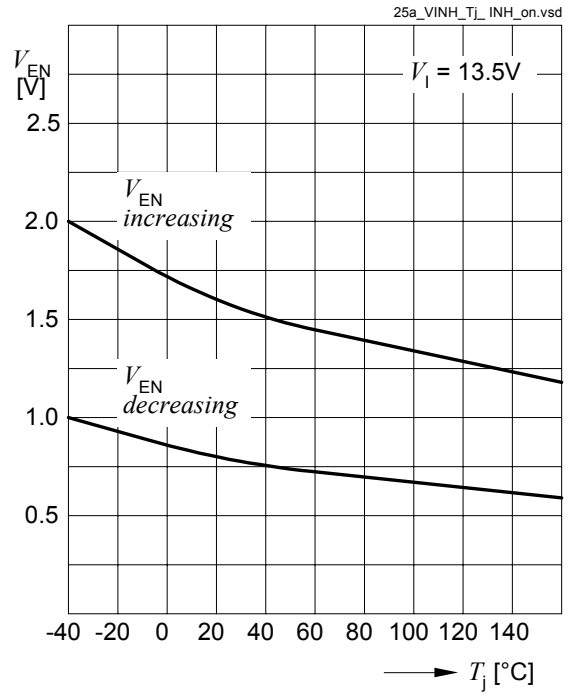

Reset Threshold V_{RT} versus Junction Temperature T_j (5V-Version)

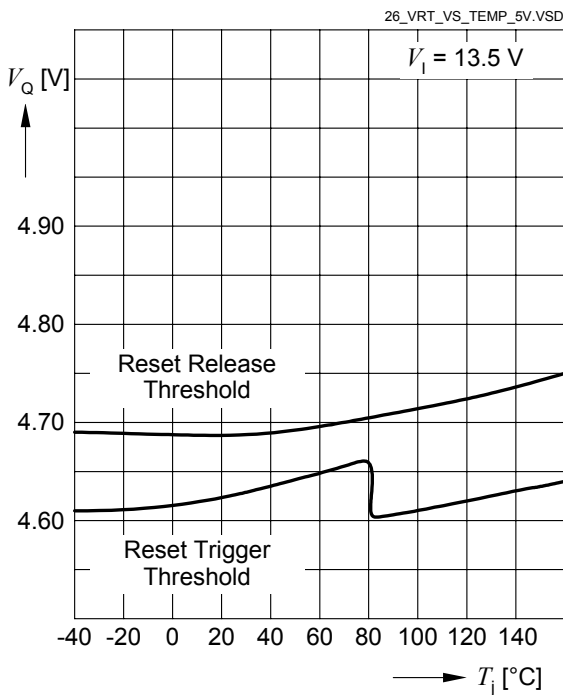

Reset Hysteresis versus Junction Temperature T_j (5V-Version)

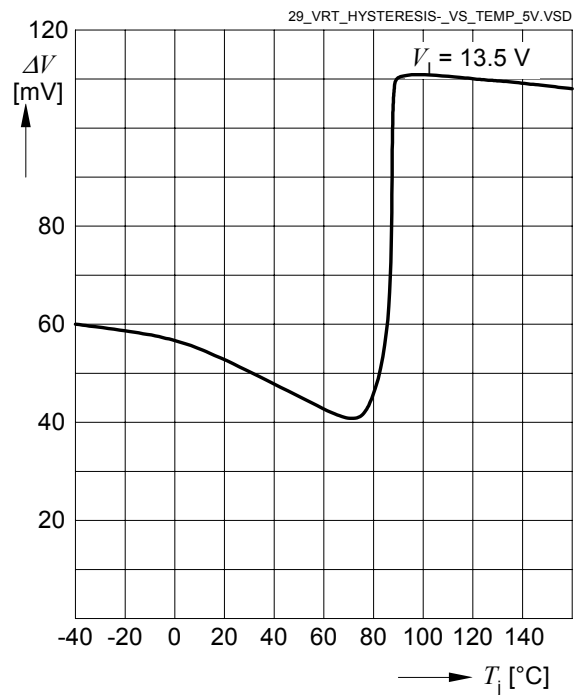

Typical Performance Characteristics (cont'd)

Reset Threshold V_{RT} versus Junction Temperature T_j (3.3V-Version)

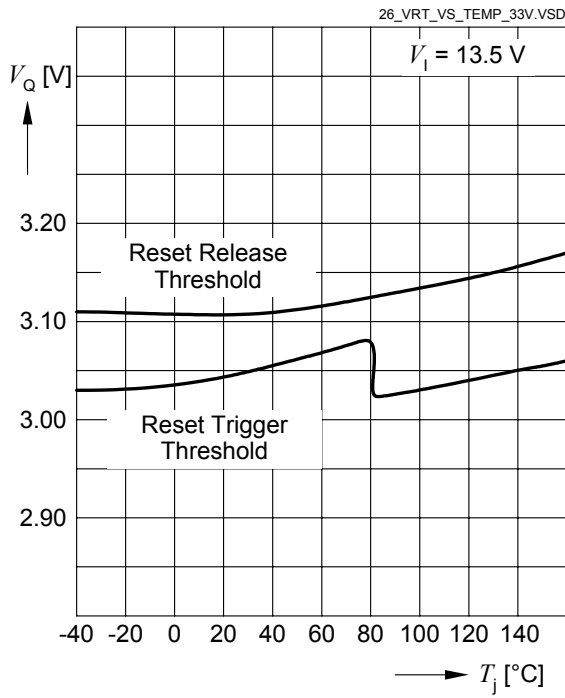

Reset Hysteresis versus Junction Temperature T_j (3.3V-Version)

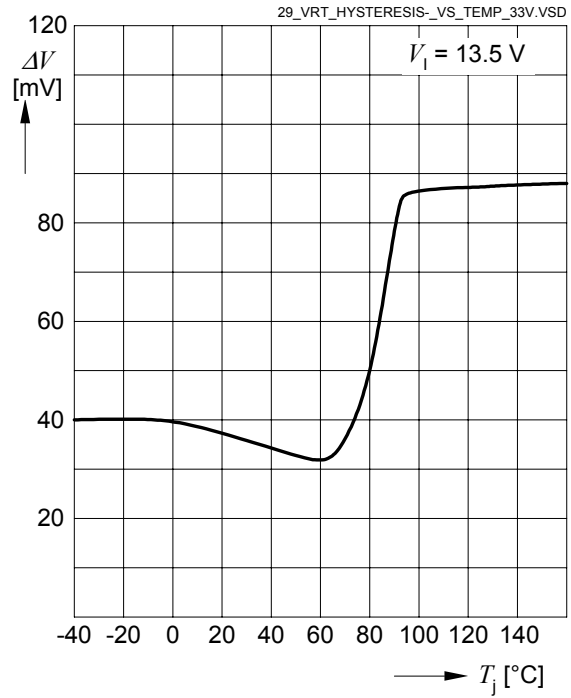

Reset Threshold V_{RT} versus Junction Temperature T_j (2.6V-Version)

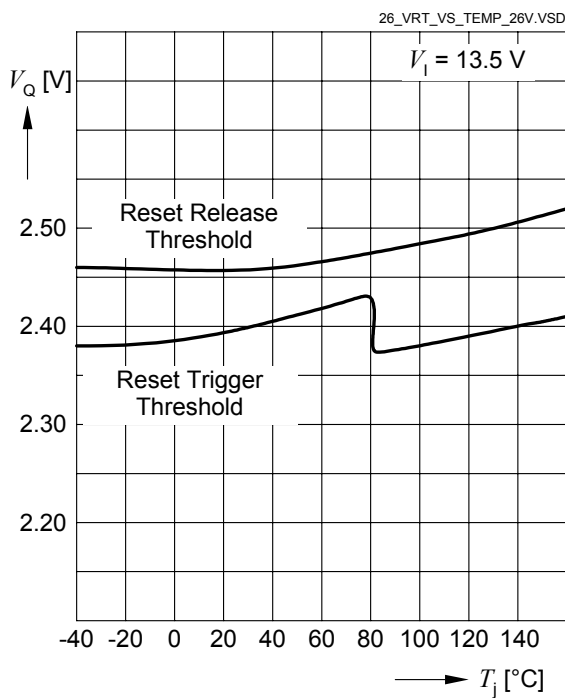

Reset Hysteresis versus Junction Temperature T_j (2.6V-Version)

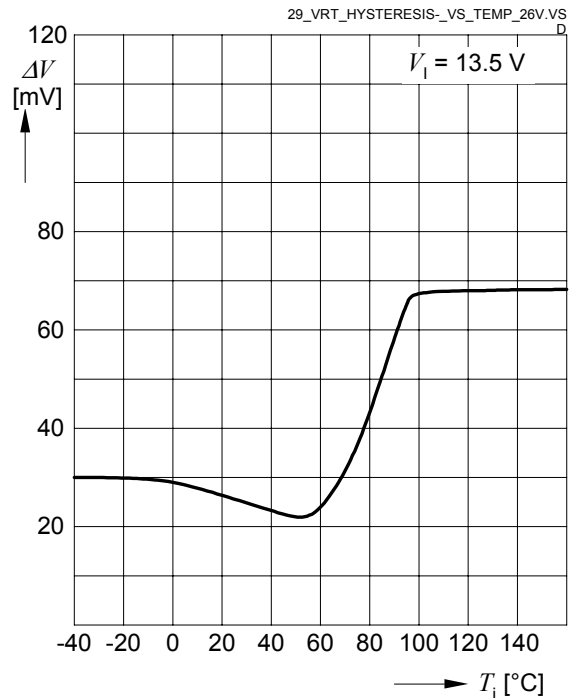

Typical Performance Characteristics (cont'd)

Reset Reaction Time t_{RR} versus Junction Temperature T_j

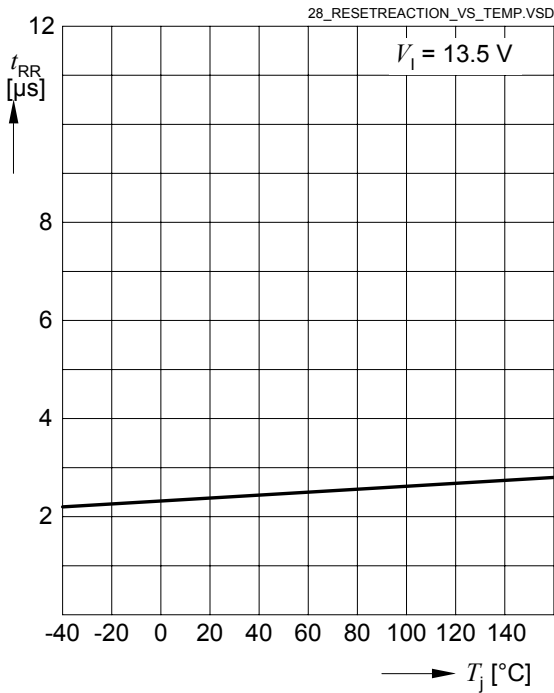

Reset Delay t_{RD} Time versus Junction Temperature T_j

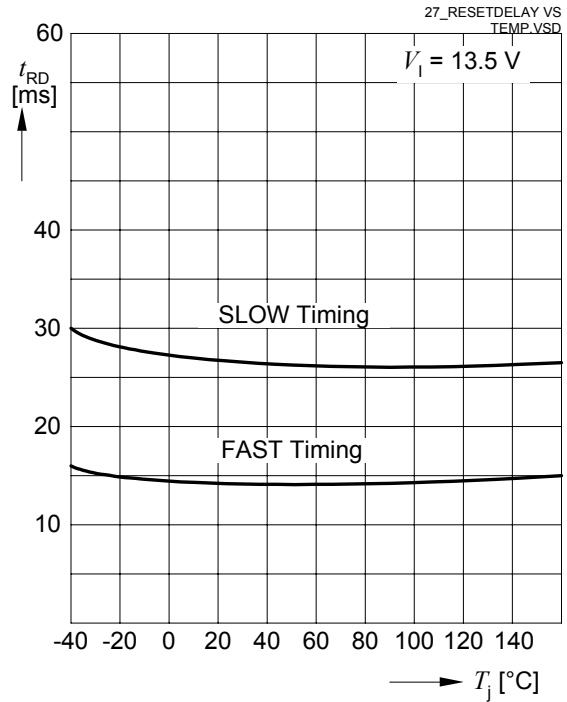

Reset Output Sink Current I_{RO} versus Junction Temperature T_j

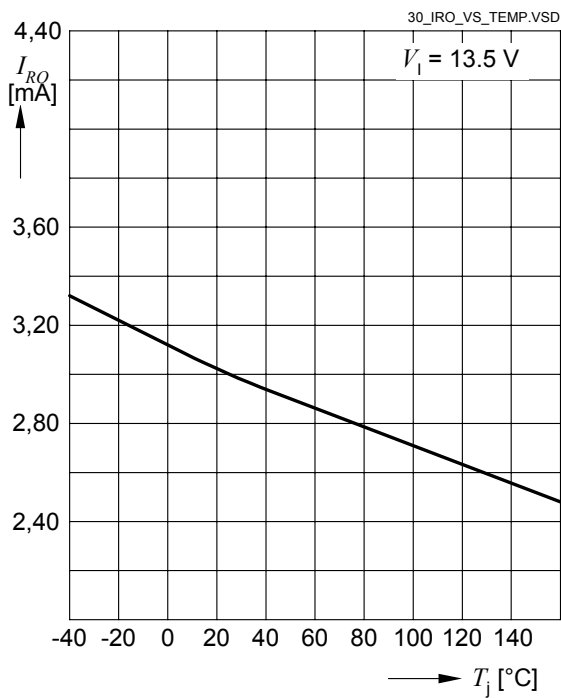

Watchdog Timing t_{WD} versus Junction Temperature T_j

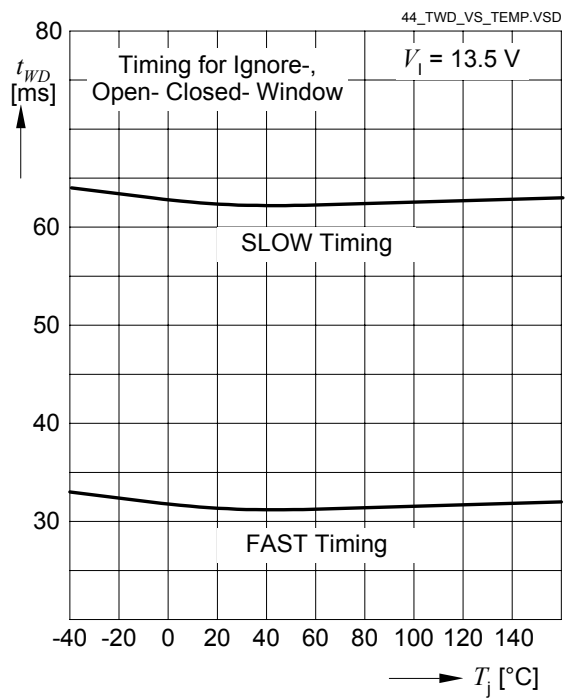

Typical Performance Characteristics (cont'd)

Region of Stability $ESR(C_Q)$ versus Output Current I_Q

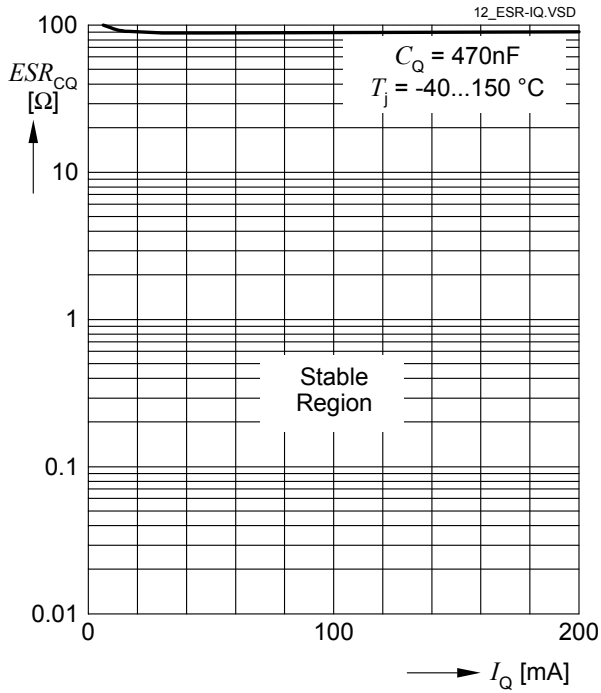

6 Package Outlines

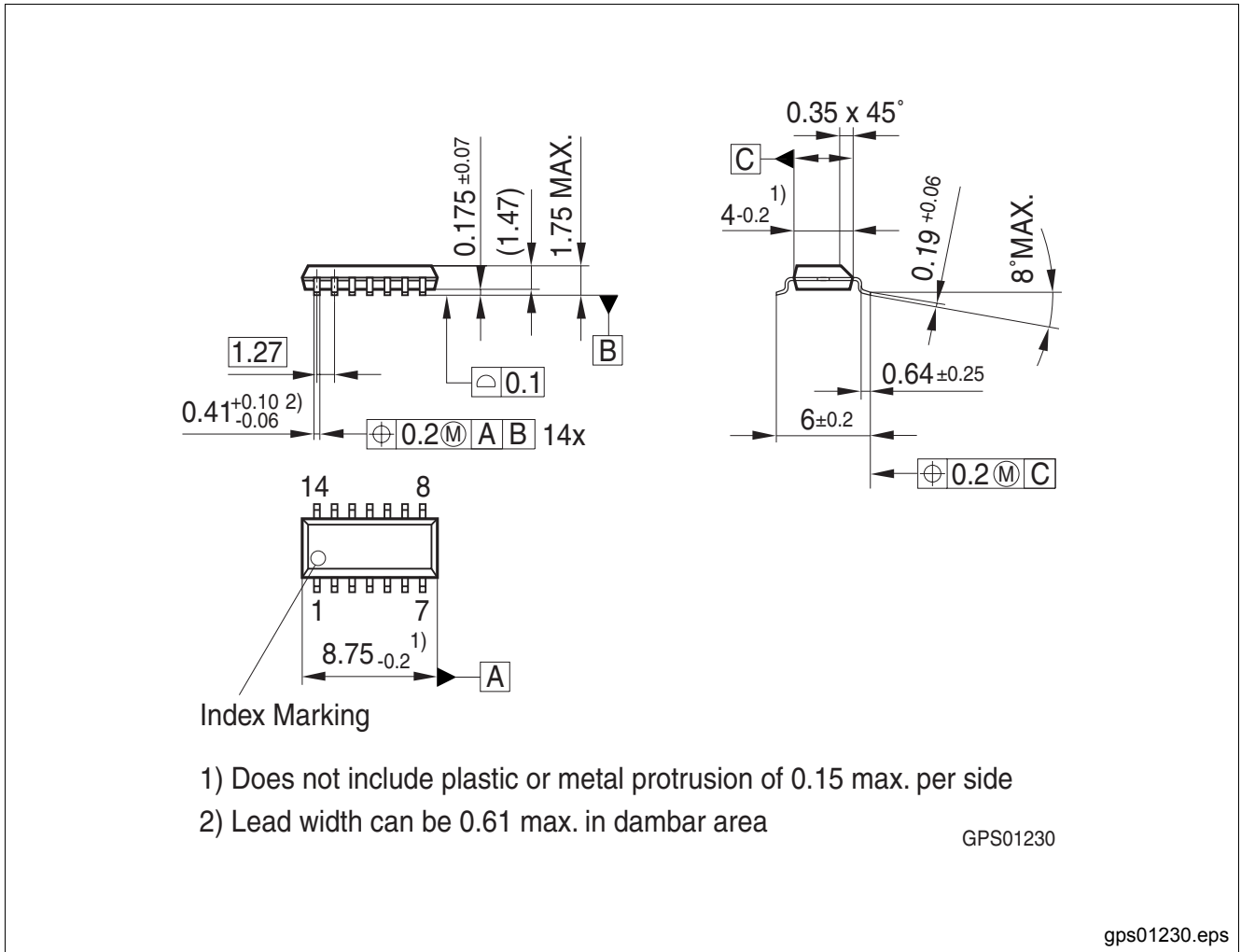

Figure 8 PG-DSO-14

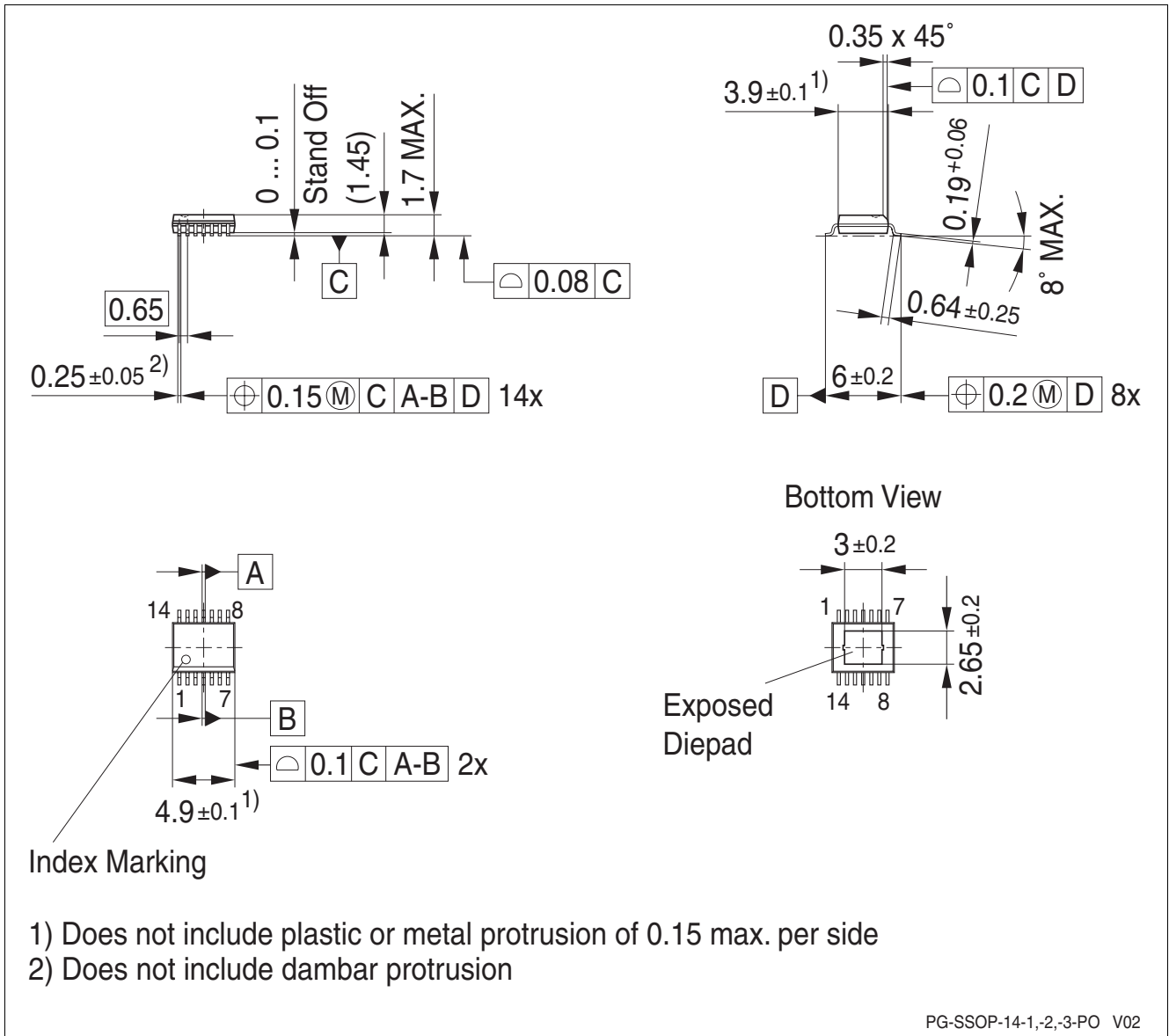

Figure 9 PG-SSOP-14 Exposed Pad

Green Product (RoHS compliant)

To meet the world-wide customer requirements for environmentally friendly products and to be compliant with government regulations the device is available as a green product. Green products are RoHS-Compliant (i.e Pb-free finish on leads and suitable for Pb-free soldering according to IPC/JEDEC J-STD-020).

You can find all of our packages, sorts of packing and others in our Infineon Internet Page "Products": <http://www.infineon.com/products>.

Dimensions in mm

7 Revision History

Revision	Date	Changes
1.2	2009-04-28	2.6V version, 5V version in PG-SSOP-14 package and all related description added:
		In “Features” on Page 2 “or 2.6 V” added
		In “Features” on Page 2 package drawing for PG-DSO-14 updated, package drawing for PG-SSOP-14 added
		In “Overview” on Page 2 in table at the bottom type “TLE7273-2GV26” and “TLE7273-2EV50” added
		In “Pin Definitions and Functions (PG-DSO-14)” on Page 4 in description for Pin 1 “, TLE7273-2GV26” added
		“Pin Assignments (PG-SSOP-14 Exposed Pad)” on Page 5 and “Pin Definitions and Functions (PG-SSOP-14 Exposed Pad)” on Page 5 added;
		In “Functional Range” on Page 7 Item 4.2.3 added, in Item 4.2.1 “, TLE7273-2EV50” added;
		In “Thermal Resistances” on Page 7 values for PG-SSOP-14 package added: Item 4.3.6, Item 4.3.7, Item 4.3.8, Item 4.3.9 and Item 4.3.10 added
		In “Power On Reset and Reset Output” on Page 8 “TLE7273-2EV50” in description added
		In “Electrical Characteristics” on Page 11 all specific Items for 2.6V version added: Item 5.2.5, Item 5.2.6, Item 5.2.22, Item 5.2.26, Item 5.2.30, Item 5.2.48, Item 5.2.52 and Item 5.2.57 added; In Item 5.2.44, Item 5.2.45, Item 5.2.49, Item 5.2.50, Item 5.2.51 and Item 5.2.60 Conditions for 2.6V version added; In Item 5.2.1, Item 5.2.2, Item 5.2.9, Item 5.2.20, Item 5.2.24, Item 5.2.28, Item 5.2.44, Item 5.2.45, Item 5.2.46, Item 5.2.54, Item 5.2.55, Item 5.2.59 and Item 5.2.61 “, TLE7273-2EV50” added
		In “Typical Performance Characteristics” on Page 15 Graphs “Reset Threshold VRT versus Junction Temperature Tj (3.3V-Version)” on Page 19, “Reset Threshold VRT versus Junction Temperature Tj (3.3V-Version)” on Page 19, “Reset Threshold VRT versus Junction Temperature Tj (2.6V-Version)” on Page 19 and “Reset Hysteresis versus Junction Temperature Tj (3.3V-Version)” on Page 19 added
		In “Package Outlines” on Page 22 Outlines for PG-SSOP-14 added: Figure 9

Revision History

Revision	Date	Changes
1.1	2008-07-25	<p>3.3V version and all related description added:</p> <p>In “Features” on Page 2 “3.3V” added</p> <p>In “Overview” on Page 2 in table at the bottom type “TLE7273-2GV33” added</p> <p>In “Pin Definitions and Functions (PG-DSO-14)” on Page 4 in description for Pin 1 “TLE7273-2GV33: open drain output;” added</p> <p>In “Functional Range” on Page 7 Item 4.2.2 added</p> <p>In “Power On Reset and Reset Output” on Page 8 description for dimensioning external pull-up resistor at RO added;</p> <p>In “Electrical Characteristics” on Page 11 all specific Items for 3.3V version added: Item 5.2.3, Item 5.2.4, Item 5.2.21, Item 5.2.25, Item 5.2.29, Item 5.2.47, Item 5.2.49, Item 5.2.50, Item 5.2.51, Item 5.2.53, Item 5.2.56 and Item 5.2.60 added; In Item 5.2.44 and Item 5.2.45 Conditions for 3.3V version added;</p>
1.0	2008-04-10	final version data sheet

Edition 2009-04-28

**Published by
Infineon Technologies AG
81726 Munich, Germany**

**© 2009 Infineon Technologies AG
All Rights Reserved.**

Legal Disclaimer

The information given in this document shall in no event be regarded as a guarantee of conditions or characteristics. With respect to any examples or hints given herein, any typical values stated herein and/or any information regarding the application of the device, Infineon Technologies hereby disclaims any and all warranties and liabilities of any kind, including without limitation, warranties of non-infringement of intellectual property rights of any third party.

Information

For further information on technology, delivery terms and conditions and prices, please contact the nearest Infineon Technologies Office (www.infineon.com).

Warnings

Due to technical requirements, components may contain dangerous substances. For information on the types in question, please contact the nearest Infineon Technologies Office.

Infineon Technologies components may be used in life-support devices or systems only with the express written approval of Infineon Technologies, if a failure of such components can reasonably be expected to cause the failure of that life-support device or system or to affect the safety or effectiveness of that device or system. Life support devices or systems are intended to be implanted in the human body or to support and/or maintain and sustain and/or protect human life. If they fail, it is reasonable to assume that the health of the user or other persons may be endangered.