

# TLP181

Office Machine  
 Programmable Controllers  
 AC / DC-Input Module  
 Telecommunication

The TOSHIBA mini flat coupler TLP181 is a small outline coupler, suitable for surface mount assembly. TLP181 consist of a photo transistor optically coupled to a gallium arsenide infrared emitting diode.

- Collector-emitter voltage: 80V (min.)
- Current transfer ratio: 50% (min.)  
     Rank GB: 100% (min.)
- Isolation voltage: 3750Vrms (min.)
- UL recognized: UL1577,  
     file no. E67349
- Option (V4) type  
     VDE approved: EN 60747-5-2 satisfied  
     Maximum operating insulation voltage: 565V<sub>PK</sub>  
     Highest permissible over voltage: 6000V<sub>PK</sub>
- BSI approved: BS EN60065:2002, certificate no.8285  
     BS EN60950-1:2002, certificate no.8286

Unit in mm

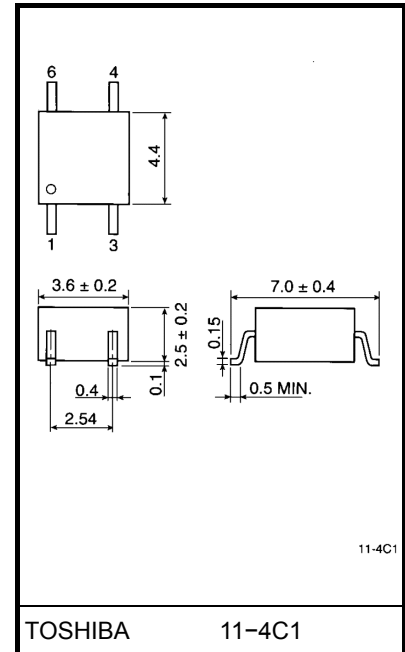

Weight: 0.09 g

### Pin Configuration (top view)

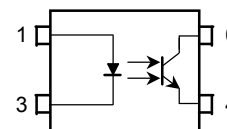

- 1: Anode
- 3: Cathode
- 4: Emitter
- 6: Collector

## Current Transfer Ratio

| Type   | Classification<br>*1 | Current Transfer Ratio (%)<br>( $I_C / I_F$ )                  |      | Marking Of Classification   |
|--------|----------------------|--|------|---|
|        |                      | $I_F = 5\text{mA}, V_{CE} = 5\text{V}, T_a = 25^\circ\text{C}$ |      |   |
|        |                      | Min.   | Max. |   |
| TLP181 | (None)               | 50   | 600  | BLANK, Y, Y <sup>■</sup> , G, G <sup>■</sup> , B, B <sup>■</sup> , GB |
|        | Rank Y               | 50   | 150  | Y, Y <sup>■</sup>   |
|        | Rank GR              | 100  | 300  | G, G <sup>■</sup>   |
|        | Rank BL              | 200  | 600  | B, B <sup>■</sup>   |
|        | Rank GB              | 100  | 600  | G, G <sup>■</sup> , B, B <sup>■</sup> , GB                            |

\*1: EX, Rank GB: TLP181 (GB)

(Note) Application, type name for certification test, please use standard product type name, i. e.  
TLP181 (GB): TLP181

## Absolute Maximum Ratings (Ta = 25°C)

| Characteristic  |   | Symbol                        | Rating                | Unit      |
|---|---|-------------------------------|-----------------------|-----------|
| LED   | Forward current   | $I_F$                         | 50                    | mA        |
|   | Forward current derating  | $\Delta I_F / ^\circ\text{C}$ | -0.7 (Ta $\geq$ 53°C) | mA / °C   |
|   | Pulse forward current (100µs pulse, 100pps)                     | $I_{FP}$                      | 1                     | A         |
|   | Reverse voltage   | $V_R$                         | 5                     | V         |
|   | Junction temperature  | $T_j$                         | 125                   | °C        |
| Detector  | Collector-emitter voltage                                       | $V_{CEO}$                     | 80                    | V         |
|   | Emitter-collector voltage                                       | $V_{ECO}$                     | 7                     | V         |
|   | Collector current   | $I_C$                         | 50                    | mA        |
|   | Collector power dissipation (1 Circuit)                         | $P_C$                         | 150                   | mW        |
|   | Collector power dissipation derating (1 Circuit Ta $\geq$ 25°C) | $\Delta P_C / ^\circ\text{C}$ | -1.5                  | mW / °C   |
|   | Junction temperature  | $T_j$                         | 125                   | °C        |
| Storage temperature range                                 |   | $T_{stg}$                     | -55~125               | °C        |
| Operating temperature range                               |   | $T_{opr}$                     | -55~100               | °C        |
| Lead soldering temperature                                |   | $T_{sol}$                     | 260 (10s)             | °C        |
| Total package power dissipation                           |   | $P_T$                         | 200                   | mW        |
| Total package power dissipation derating (Ta $\geq$ 25°C) |   | $\Delta P_T / ^\circ\text{C}$ | -2.0                  | mW / °C   |
| Isolation voltage (AC, 1min., R.H. $\leq$ 60%) (Note 1)   |   | $BV_S$                        | 3750                  | $V_{rms}$ |

Note: Using continuously under heavy loads (e.g. the application of high temperature/current/voltage and the significant change in temperature, etc.) may cause this product to decrease in the reliability significantly even if the operating conditions (i.e. operating temperature/current/voltage, etc.) are within the absolute maximum ratings.

Please design the appropriate reliability upon reviewing the Toshiba Semiconductor Reliability Handbook ("Handling Precautions"/"Derating Concept and Methods") and individual reliability data (i.e. reliability test report and estimated failure rate, etc).

(Note 1) Device considered a two-terminal device: Pin1, 3 shorted together and pins 4, 6 shorted together

## Recommended Operating Conditions

| Characteristic        | Symbol    | Min. | Typ. | Max. | Unit |
|-----------------------|-----------|------|------|------|------|
| Supply voltage        | $V_{CC}$  | —    | 5    | 48   | V    |
| Forward current       | $I_F$     | —    | 16   | 20   | mA   |
| Collector current     | $I_C$     | —    | 1    | 10   | mA   |
| Operating temperature | $T_{opr}$ | -25  | —    | 85   | °C   |

Note: Recommended operating conditions are given as a design guideline to obtain expected performance of the device. Additionally, each item is an independent guideline respectively. In developing designs using this product, please confirm specified characteristics shown in this document.

## Individual Electrical Characteristics (Ta = 25°C)

| Characteristic                     |                                     | Symbol                     | Test Condition  | Min. | Typ.     | Max.     | Unit          |
|------------------------------------|-------------------------------------|----------------------------|---|------|----------|----------|---------------|
| LED                                | Forward voltage                     | $V_F$                      | $I_F = 10 \text{ mA}$   | 1.0  | 1.15     | 1.3      | V             |
|                                    | Reverse current                     | $I_R$                      | $V_R = 5 \text{ V}$   | —    | —        | 10       | $\mu\text{A}$ |
|                                    | Capacitance                         | $C_T$                      | $V = 0, f = 1 \text{ MHz}$  | —    | 30       | —        | pF            |
| Detector                           | Collector-emitter breakdown voltage | $V_{(BR)CEO}$              | $I_C = 0.5 \text{ mA}$  | 80   | —        | —        | V             |
|                                    | Emitter-collector breakdown voltage | $V_{(BR)ECO}$              | $I_E = 0.1 \text{ mA}$  | 7    | —        | —        | V             |
|                                    | Collector dark current              | $I_{CEO}$                  | $V_{CE} = 48 \text{ V}, (\text{ Ambient light below } 1000 \text{ lx})$                         | —    | 0.01 (2) | 0.1 (10) | $\mu\text{A}$ |
|                                    |                                     |                            | $V_{CE} = 48 \text{ V}, T_a = 85^\circ\text{C}, (\text{ Ambient light below } 1000 \text{ lx})$ | —    | 2 (4)    | 50 (50)  | $\mu\text{A}$ |
| Capacitance (collector to emitter) | $C_{CE}$                            | $V = 0, f = 1 \text{ MHz}$ | —   | 10   | —        | pF       |               |

## Coupled Electrical Characteristics (Ta = 25°C)

| Characteristic                       | Symbol                   | Test Condition  | Min. | Typ. | Max. | Unit          |
|--------------------------------------|--------------------------|---|------|------|------|---------------|
| Current transfer ratio               | $I_C / I_F$              | $I_F = 5 \text{ mA}, V_{CE} = 5 \text{ V}$<br>Rank GB   | 50   | —    | 600  | %             |
|                                      |                          |   | 100  | —    | 600  |               |
| Saturated CTR                        | $I_C / I_F (\text{sat})$ | $I_F = 1 \text{ mA}, V_{CE} = 0.4 \text{ V}$<br>Rank GB   | —    | 60   | —    | %             |
|                                      |                          |   | 30   | —    | —    |               |
| Collector-emitter saturation voltage | $V_{CE} (\text{sat})$    | $I_C = 2.4 \text{ mA}, I_F = 8 \text{ mA}$<br>$I_C = 0.2 \text{ mA}, I_F = 1 \text{ mA}$<br>Rank GB | —    | —    | 0.4  | V             |
|                                      |                          |   | —    | 0.2  | —    |               |
|                                      |                          |   | —    | —    | 0.4  |               |
| Off-state collector current          | $I_C (\text{off})$       | $V_F = 0.7 \text{ V}, V_{CE} = 48 \text{ V}$  | —    | 1    | 10   | $\mu\text{A}$ |

## Isolation Characteristics (Ta = 25°C)

| Characteristic                | Symbol | Test Condition                                | Min.               | Typ.      | Max. | Unit             |
|-------------------------------|--------|---|--------------------|-----------|------|------------------|
| Capacitance (input to output) | $C_S$  | $V_S = 0 \text{ V}, f = 1 \text{ MHz}$        | —                  | 0.8       | —    | pF               |
| Isolation resistance          | $R_S$  | $V_S = 500 \text{ V}, \text{ R.H.} \leq 60\%$ | $1 \times 10^{12}$ | $10^{14}$ | —    | $\Omega$         |
| Isolation voltage             | $BV_S$ | AC, 1 minute                                  | 3750               | —         | —    | $V_{\text{rms}}$ |
|                               |        | AC, 1 second, in oil                          | —                  | 10000     | —    |                  |
|                               |        | DC, 1 minute, in oil                          | —                  | 10000     | —    | $V_{\text{dc}}$  |

**Switching Characteristics (Ta = 25°C)**

| Characteristic | Symbol    | Test Condition   | Min. | Typ. | Max. | Unit          |
|----------------|-----------|--|------|------|------|---------------|
| Rise time      | $t_r$     | $V_{CC} = 10\text{ V}$ , $I_C = 2\text{ mA}$<br>$R_L = 100\Omega$                  | —    | 2    | —    | $\mu\text{s}$ |
| Fall time      | $t_f$     |  | —    | 3    | —    |               |
| Turn-on time   | $t_{on}$  |  | —    | 3    | —    |               |
| Turn-off time  | $t_{off}$ |  | —    | 3    | —    |               |
| Turn-on time   | $t_{ON}$  | $R_L = 1.9\text{ k}\Omega$<br>$V_{CC} = 5\text{ V}$ , $I_F = 16\text{ mA}$ (Fig.1) | —    | 2    | —    | $\mu\text{s}$ |
| Storage time   | $t_s$     |  | —    | 25   | —    |               |
| Turn-off time  | $t_{OFF}$ |  | —    | 40   | —    |               |

Fig. 1 Switching time test circuit

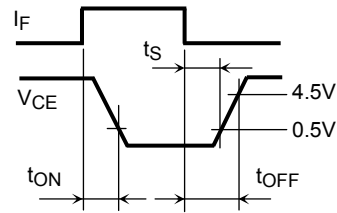
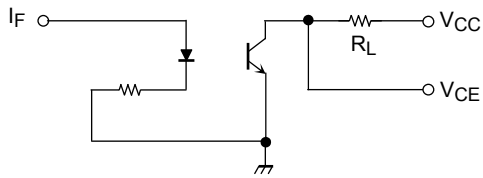

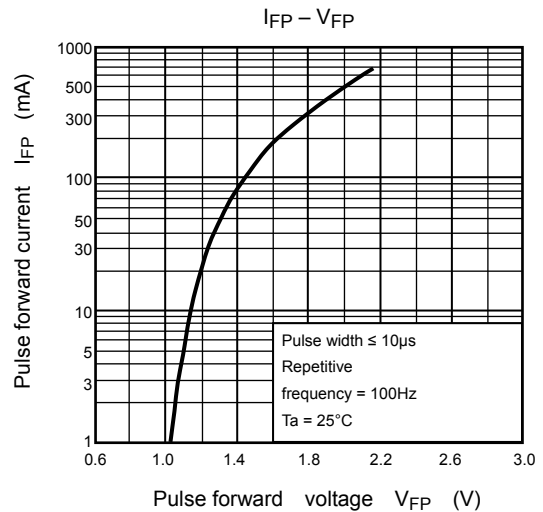
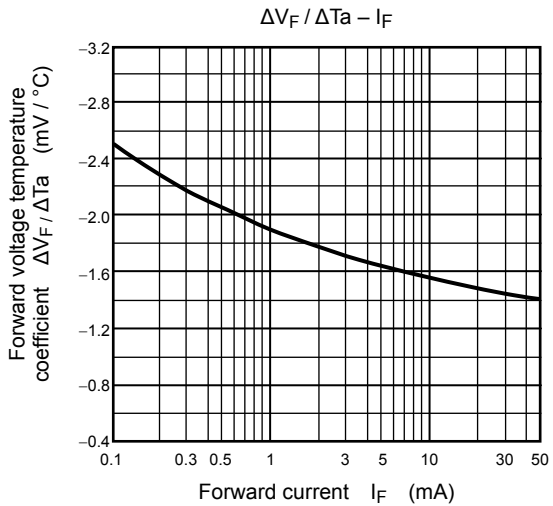
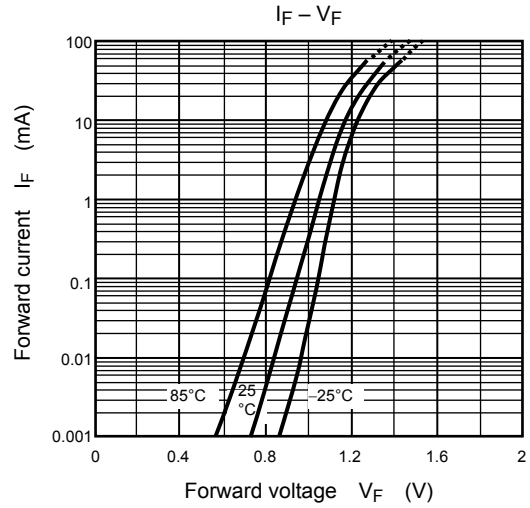
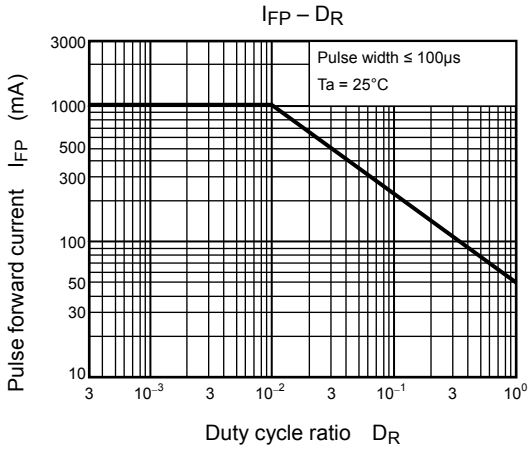
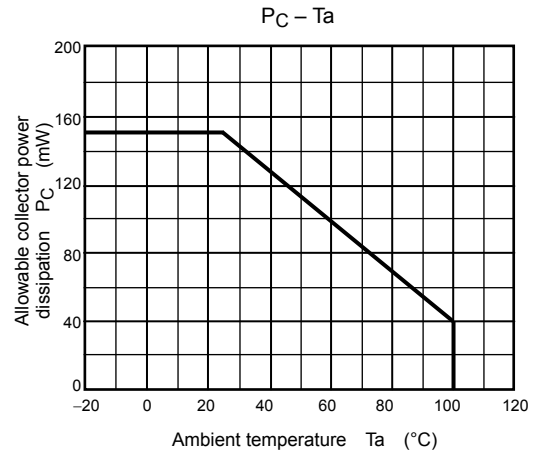
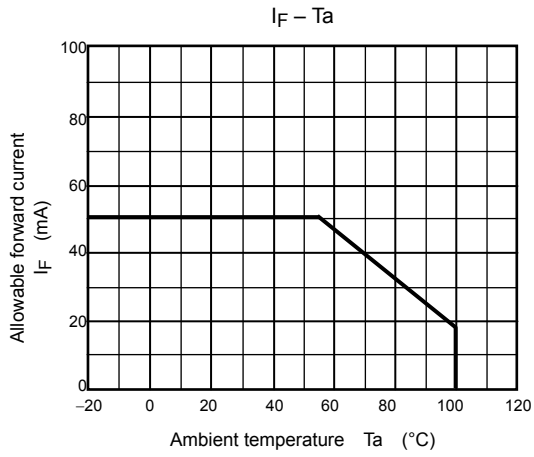

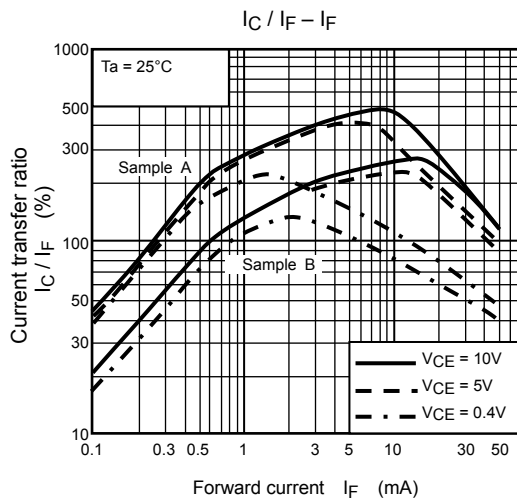
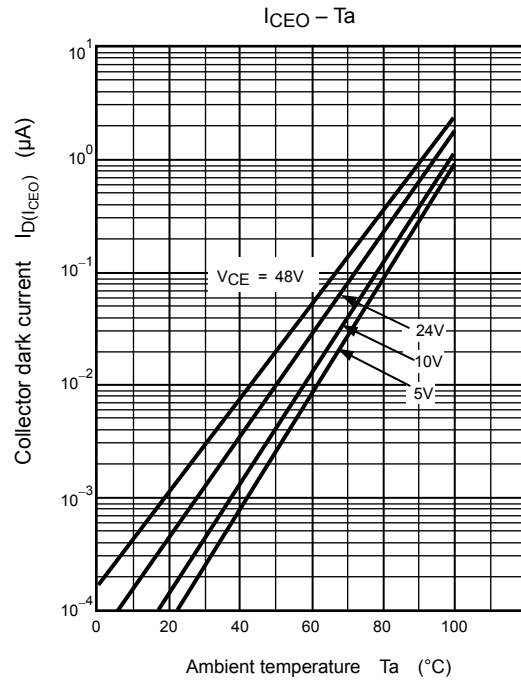
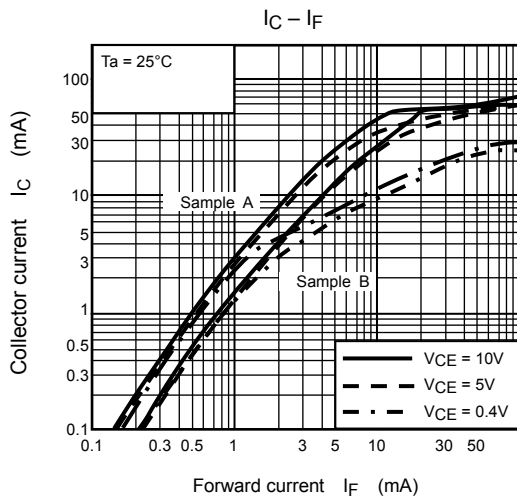
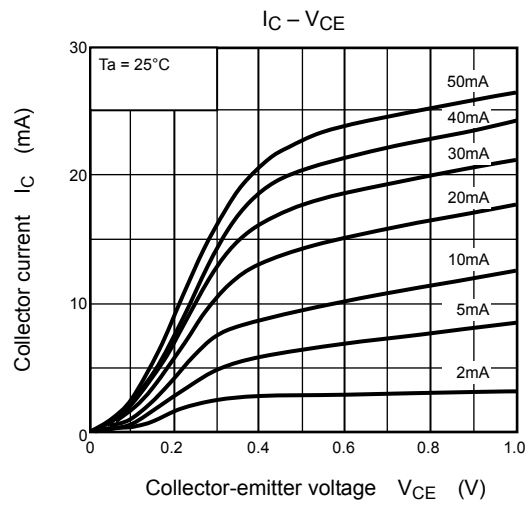
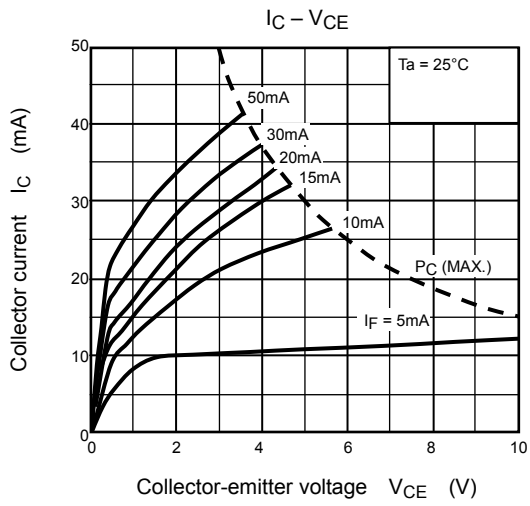

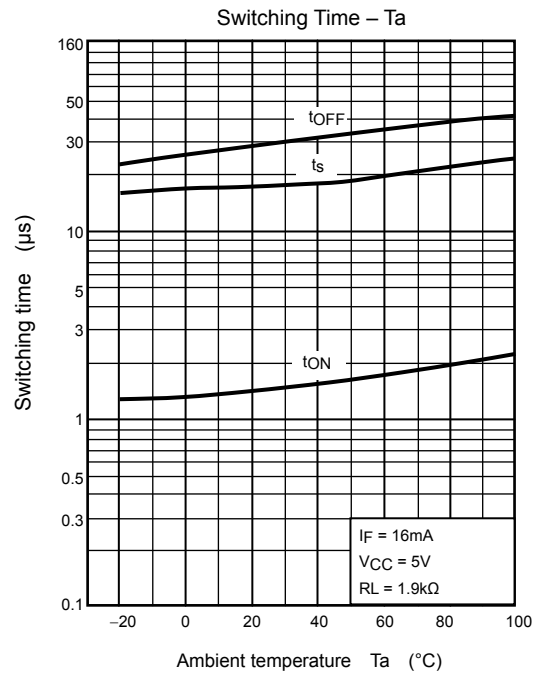
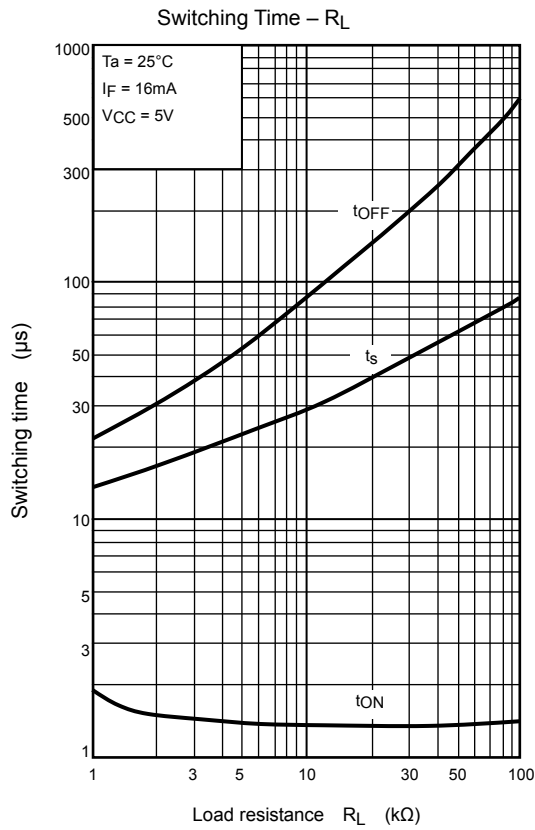
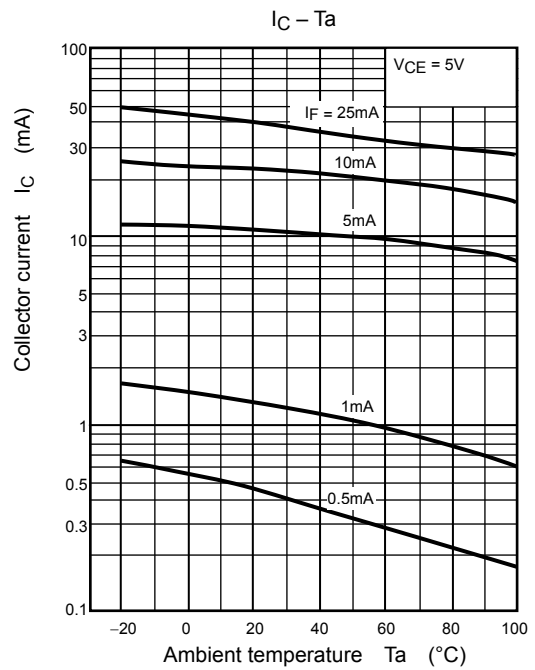
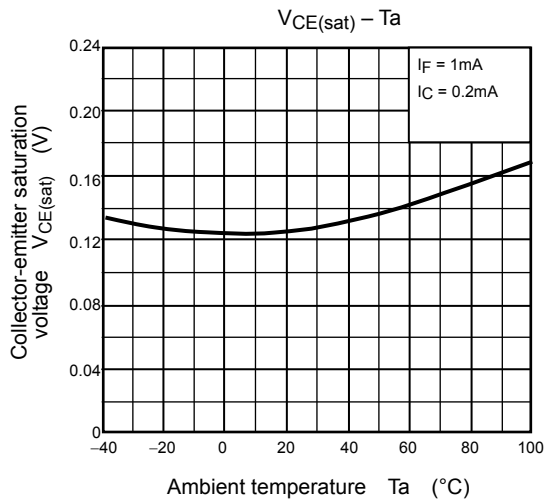



**RESTRICTIONS ON PRODUCT USE**

20070701-EN

- The information contained herein is subject to change without notice.
- TOSHIBA is continually working to improve the quality and reliability of its products. Nevertheless, semiconductor devices in general can malfunction or fail due to their inherent electrical sensitivity and vulnerability to physical stress. It is the responsibility of the buyer, when utilizing TOSHIBA products, to comply with the standards of safety in making a safe design for the entire system, and to avoid situations in which a malfunction or failure of such TOSHIBA products could cause loss of human life, bodily injury or damage to property.  
In developing your designs, please ensure that TOSHIBA products are used within specified operating ranges as set forth in the most recent TOSHIBA products specifications. Also, please keep in mind the precautions and conditions set forth in the "Handling Guide for Semiconductor Devices," or "TOSHIBA Semiconductor Reliability Handbook" etc.
- The TOSHIBA products listed in this document are intended for usage in general electronics applications (computer, personal equipment, office equipment, measuring equipment, industrial robotics, domestic appliances, etc.). These TOSHIBA products are neither intended nor warranted for usage in equipment that requires extraordinarily high quality and/or reliability or a malfunction or failure of which may cause loss of human life or bodily injury ("Unintended Usage"). Unintended Usage include atomic energy control instruments, airplane or spaceship instruments, transportation instruments, traffic signal instruments, combustion control instruments, medical instruments, all types of safety devices, etc.. Unintended Usage of TOSHIBA products listed in this document shall be made at the customer's own risk.
- The products described in this document shall not be used or embedded to any downstream products of which manufacture, use and/or sale are prohibited under any applicable laws and regulations.
- The information contained herein is presented only as a guide for the applications of our products. No responsibility is assumed by TOSHIBA for any infringements of patents or other rights of the third parties which may result from its use. No license is granted by implication or otherwise under any patents or other rights of TOSHIBA or the third parties.
- GaAs(Gallium Arsenide) is used in this product. The dust or vapor is harmful to the human body. Do not break, cut, crush or dissolve chemically.
- Please contact your sales representative for product-by-product details in this document regarding RoHS compatibility. Please use these products in this document in compliance with all applicable laws and regulations that regulate the inclusion or use of controlled substances. Toshiba assumes no liability for damage or losses occurring as a result of noncompliance with applicable laws and regulations.