

LM3554

*LM3554 Synchronous Boost Converter with 1.2A Dual High Side LED Drivers
and I²C-Compatible Interface*



Literature Number: SNVS549A

LM3554

Synchronous Boost Converter with 1.2A Dual High Side LED Drivers and I²C-Compatible Interface

General Description

The LM3554 is a 2MHz fixed frequency, current mode synchronous boost converter. The device is designed to operate as a dual 600mA (1.2A total) constant-current driver for high-current white LEDs, or as a regulated 4.5V or 5V voltage source.

The dual high-side current sources allow for grounded cathode LED operation. An adaptive regulation method ensures the current source for each LED remains in regulation and maximizes efficiency.

The main features include: an I²C-compatible interface for controlling the LED current or the desired output voltage, a hardware Flash enable input for direct triggering of the Flash pulse, and dual TX inputs which force the Flash pulse into a low-current Torch mode allowing for synchronization to RF power amplifier events or other high-current conditions. Additionally, an active high hardware enable (HWEN) input provides a hardware shutdown during system software failures.

Five protection features are available within the LM3554 including a software selectable input voltage monitor, an internal comparator for interfacing with an external temperature sensor, four selectable current limits to ensure the battery current is kept below a predetermined peak level, an over-voltage protection feature to limit the output voltage during LED open circuits, and an output short circuit protection which limits the output current during shorts to GND. Additionally, the device provides various fault indicators including: a thermal fault flag indicating the LED temperature has tripped the thermal threshold, a flag indicating a TX event has occurred, a flag indicating the flash timeout counter has expired, a flag indicating the devices die temperature has reached the thermal shutdown threshold, and a flag indicating an open or short LED.

Features

- Dual High Side Current Sources
- Grounded Cathode Allowing for Better Heat Sinking and LED Routing
- >90% Efficiency
- Ultra-Small Solution Size: < 23mm²
- Four Operating Modes: Torch, Flash, LED Indicator and Voltage Output
- Accurate and Programmable LED Current from 37.5mA to 1.2A
- Programmable 4.5V or 5.0V Constant Output Voltage
- Hardware Flash and Torch Enable
- LED Thermal Sensing and Current Scaleback
- Software Selectable Input Voltage Monitor
- Programmable Flash Timeout
- Dual Synchronization Inputs for RF Power Amplifier Pulse Events
- Open and Short LED Detection
- Active High Hardware Enable for Protection Against System Faults
- 400kHz I²C-Compatible Interface
- 16-Bump (1.7mm × 1.7mm × 0.6mm) micro SMD

Applications

- Camera Phone LED Flash Controller
- Class D Audio Amplifier Power
- LED Current Source Biasing

Typical Application Circuits

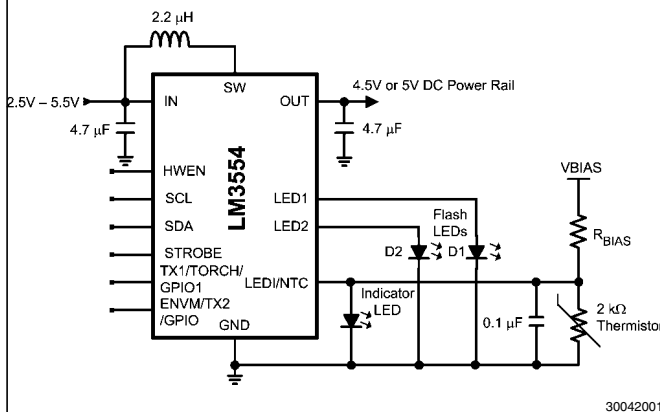

30042001

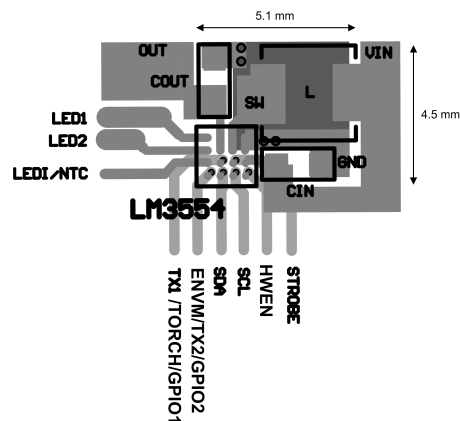

Example Layout

30042002

Application Circuit Component List

Component	Manufacturer	Value	Part Number	Size (mm)	Rating
L	TOKO	2.2 μ H	FDSE0312-2R2M	3x3x1.2	2.3A(0.2 Ω)
COUT	Murata	4.7 μ F/10 μ F	GRM188R60J475M, or GRM188R60J106M	1.6x0.8x0.8 (0603)	6.3V
CIN	Murata	4.7 μ F	GRM185R60J475M	1.6x0.8x0.8 (0603)	6.3V
LEDs	Lumiled		LXCL-PWF4		1.5A

Connection Diagram

Top View

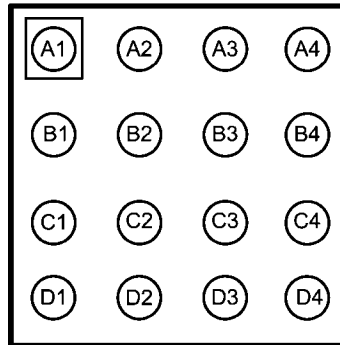

30042003

Pin Descriptions

Pin	Name	Function
A1	LED1	High-Side Current Source Output for Flash LED.
A2, B2	OUT	Step-Up DC/DC Converter Output.
A3, B3	SW	Drain Connection for Internal NMOS and Synchronous PMOS Switches.
A4, B4	GND	Ground
B1	LED2	High-Side Current Source Output for Flash LED.
C1	LEDI/NTC	Configurable as a High-Side Current Source Output for Indicator LED or Threshold Detector for LED Temperature Sensing.
C2	TX1/TORCH/ GPIO1	Configurable as a RF Power Amplifier Synchronization Control Input (TX1), a Hardware Torch Enable (TORCH), or a programmable general-purpose logic Input/Output (GPIO1).
C3	STROBE	Active High Hardware Flash Enable. Drive STROBE high to turn on Flash pulse.
C4	IN	Input Voltage Connection. Connect IN to the input supply, and bypass to GND with a minimum 4.7 μ F ceramic capacitor.
D1	ENVM/TX2/ GPIO2/INT	Configurable as an Active High Voltage Mode Enable (ENVM), Dual Polarity Power Amplifier Synchronization Input (TX2), or Programmable General Purpose Logic Input/Output (GPIO2).
D2	SDA	Serial Data Input/Output.
D3	SCL	Serial Clock Input.
D4	HWEN	Active Low Hardware Reset.

Ordering Information

Order Number	Package	Package Marking	Supplied As	No-Lead
LM3554TME	TMD16CCA	SF	250 units, Tape-and-Reel	YES (NOPB)
LM3554TMX	TMD16CCA	SF	3000 units, Tape-and-Reel	YES (NOPB)

Absolute Maximum Ratings (Note 1, Note 2)

2)

If Military/Aerospace specified devices are required, please contact the National Semiconductor Sales Office/ Distributors for availability and specifications.

V_{IN}, V_{SW}, V_{OUT}	-0.3V to 6V
$V_{SCL}, V_{SDA}, V_{HWEN}, V_{STROBE}, V_{TX1/}$	-0.3V to to (V_{IN}
$TORCH, V_{ENVM/TX2}, V_{LED1}, V_{LED2}, V_{LEDI/}$	+0.3V) w/ 6.0V
NTC	max
Continuous Power Dissipation <small>(Note 3)</small>	Internally Limited
Junction Temperature (T_{J-MAX})	+150°C
Storage Temperature Range	-65°C to +150°C
Maximum Lead Temperature <small>(Soldering)</small>	<small>(Note 4)</small>

Operating Ratings (Note 1, Note 2)

V_{IN}	2.5V to 5.5V
Junction Temperature (T_J)	-30°C to +125°C
Ambient Temperature (T_A)	-30°C to +85°C

(Note 5)

Thermal Properties

Junction-to-Ambient Thermal Resistance (θ_{JA}), TMD16 Package <small>(Note 6)</small>	60°C/W
---	--------

ESD Caution Notice National Semiconductor recommends that all integrated circuits be handled with appropriate ESD precautions. Failure to observe proper ESD handling techniques can result in damage to the device.

Electrical Characteristics

Limits in standard typeface are for $T_A = +25^\circ\text{C}$. Limits in boldface type apply over the full operating ambient temperature range ($-30^\circ\text{C} \leq T_A \leq +85^\circ\text{C}$). Unless otherwise specified, $V_{IN} = 3.6\text{V}$, $V_{HWEN} = V_{IN}$. (Note 2, Note 7)

Symbol	Parameter	Conditions	Min	Typ	Max	Units	
Current Source Specifications							
I_{LED}	Current Source Accuracy	600mA Flash LED Setting, $V_{OUT} = V_{IN}$	$I_{LED1} + I_{LED2}$	1128	1200	1284	mA
		17mA Torch Current Setting, $V_{HR} = 500\text{mV}$	I_{LED1} or I_{LED2}	541	600	657	
			$I_{LED1} + I_{LED2}$	30.4	33.8	37.2	
V_{HR}	Current Source Regulation Voltage ($V_{OUT} - V_{LED}$)	600mA setting, $V_{OUT} = 3.75\text{V}$		300		mV	
I_{MATCH}	LED Current Matching	600mA setting, $V_{LED} = 3.2\text{V}$		0.35		%	
Step-Up DC/DC Converter Specifications							
V_{REG}	Output Voltage Accuracy	$2.7\text{V} \leq V_{IN} \leq 4.2\text{V}$, $I_{OUT} = 0\text{mA}$, $V_{ENVM} = V_{IN}$, OV bit = 0	4.8	5	5.2	V	
V_{OVP}	Output Over-Voltage Protection Trip Point <small>(Note 8)</small>	On Threshold, $2.7\text{V} \leq V_{IN} \leq 5.5\text{V}$	5.4	5.6	5.7	V	
		Off Threshold		5.3			
R_{PMOS}	PMOS Switch On-Resistance	$I_{PMOS} = 1\text{A}$		150		mΩ	
R_{NMOS}	NMOS Switch On-Resistance	$I_{NMOS} = 1\text{A}$		150		mΩ	
I_{CL}	Switch Current Limit <small>(Note 9)</small>	CL bits = 00	0.711	1.05	1.373	A	
		CL bits = 01	1.295	1.51	1.8		
		CL bits = 10	1.783	1.99	2.263		
		CL bits = 11	2.243	2.45	2.828		
I_{OUT_SC}	Output Short Circuit Current Limit	$V_{OUT} < 2.3\text{V}$		550		mA	

Symbol	Parameter	Conditions	Min	Typ	Max	Units	
$I_{LED/NTC}$	Indicator Current	LEDI/NTC bit = 0	IND1, IND0 bits = 00		2.3		mA
			IND1, IND0 bits = 01		4.6		
			IND1, IND0 bits = 10		6.9		
			IND1, IND0 bits = 11		8.2		
V_{TRIP}	Comparator Trip Threshold	LEDI/NTC bit = 1, $2.7V \leq V_{IN} \leq 5.5V$	0.947	1.052	1.157	V	
f_{SW}	Switching Frequency	$2.7V \leq V_{IN} \leq 5.5V$	1.75	2	2.23	MHz	
I_Q	Quiescent Supply Current	Device Not Switching		630		μA	
I_{SHDN}	Shutdown Supply Current	$2.7V \leq V_{IN} \leq 5.5V$		3.5	6.6	μA	
t_{TX}	Flash-to-Torch LED Current Settling Time	TX_ Low to High, $I_{LED1} + I_{LED2} = 1.2A$ to 180mA		20		μs	
V_{IN_TH}	VIN Monitor Trip Threshold	V_{IN} Falling, VIN Monitor Register = 0x01 (Enabled with $V_{IN_TH} = 3.1V$)	2.95	3.09	3.23	V	
TX1/TORCH/GPIO1, STROBE, HWEN, ENVM/TX2/GPIO2 Voltage Specifications							
V_{IL}	Input Logic Low	$2.7V \leq V_{IN} \leq 5.5V$	0		0.4	V	
V_{IH}	Input Logic High	$2.7V \leq V_{IN} \leq 5.5V$	1.2		V_{IN}	V	
V_{OL}	Output Logic Low	$I_{LOAD} = 3mA$, $2.7V \leq V_{IN} \leq 5.5V$			400	mV	
$R_{TX1/TORCH}$	Internal Pull-down Resistance at TX1/TORCH			300		k Ω	
R_{STROBE}	Internal Pull-Down Resistance at STROBE			300		k Ω	
I²C-Compatible Voltage Specifications (SCL, SDA)							
V_{IL}	Input Logic Low	$2.7V \leq V_{IN} \leq 5.5V$	0		0.4	V	
V_{IH}	Input Logic High	$2.7V \leq V_{IN} \leq 5.5V$	1.22		V_{IN}	V	
V_{OL}	Output Logic Low (SCL)	$I_{LOAD} = 3mA$, $2.7V \leq V_{IN} \leq 5.5V$			400	mV	
I²C-Compatible Timing Specifications (SCL, SDA) — See Figure 1							
$1/t_1$	SCL Clock Frequency			400		kHz	
t_2	Data In Setup Time to SCL High		100			ns	
t_3	Data Out Stable After SCL Low		0			ns	
t_4	SDA Low Setup Time to SCL Low (Start)		160			ns	
t_5	SDA High Hold Time After SCL High (Stop)		160			ns	

Note 1: Absolute Maximum Ratings indicate limits beyond which damage to the device may occur. Operating Ratings are conditions under which operation of the device is guaranteed. Operating Ratings do not imply guaranteed performance limits. For guaranteed performance limits and associated test conditions, see the Electrical Characteristics table.

Note 2: All voltages are with respect to the potential at the GND pin.

Note 3: Internal thermal shutdown circuitry protects the device from permanent damage. Thermal shutdown engages at $T_J=150^\circ\text{C}$ (typ.) and disengages at $T_J=135^\circ\text{C}$ (typ.).

Note 4: For detailed soldering specifications and information, please refer to National Semiconductor Application Note 1112: Micro SMD Wafer Level chip Scale Package (AN-1112)

Note 5: In applications where high power dissipation and/or poor package thermal resistance is present, the maximum ambient temperature may have to be derated. Maximum ambient temperature (T_{A-MAX}) is dependent on the maximum operating junction temperature ($T_{J-MAX-OP} = +125^\circ\text{C}$), the maximum power dissipation of the device in the application (P_{D-MAX}), and the junction-to-ambient thermal resistance of the part/package in the application (θ_{JA}), as given by the following equation: $T_{A-MAX} = T_{J-MAX-OP} - (\theta_{JA} \times P_{D-MAX})$.

Note 6: Junction-to-ambient thermal resistance (θ_{JA}) is taken from a thermal modeling result, performed under the conditions and guidelines set forth in the JEDEC standard JESD51-7. The test board is a 4-layer FR-4 board measuring 102mm x 76mm x 1.6mm with a 2x1 array of thermal via's. The ground plane on the board is 50mm x 50mm. Thickness of copper layers are 36 μm /18 μm /18 μm /36 μm (1.5oz/1oz/1oz/1.5oz). Ambient temperature in simulation is 22 $^\circ\text{C}$, still air. Power dissipation is 1W.

Note 7: Min and Max limits are guaranteed by design, test, or statistical analysis. Typical (Typ) numbers are not guaranteed, but do represent the most likely norm. Unless otherwise specified, conditions for typical specifications are: $V_{IN} = 3.6\text{V}$ and $T_A = +25^\circ\text{C}$.

Note 8: The typical curve for Over-Voltage Protection (OVP) is measured in closed loop using the typical application circuit. The OVP value is found by forcing an open circuit in the LED1 and LED2 path and recording the peak value of V_{OUT} . The value given in the Electrical Table is found in an open loop configuration by ramping the voltage at OUT until the OVP comparator trips. The closed loop data can appear higher due to the stored energy in the inductor being dumped into the output capacitor after the OVP comparator trips. At worst case is an open circuit condition where the output voltage can continue to rise after the OVP comparator trips by approximately $I_{IN} \times \sqrt{L/C_{OUT}}$.

Note 9: The typical curve for Current Limit is measured in closed loop using the typical application circuit by increasing I_{OUT} until the peak inductor current stops increasing. The value given in the Electrical Table is measured open loop and is found by forcing current into SW until the current limit comparator threshold is reached. Closed loop data appears higher due to the delay between the comparator trip point and the NFET turning off. This delay allows the closed loop inductor current to ramp higher after the trip point by approximately $20\text{ns} \times V_{IN}/L$.

Note 10: Current Matching = $\text{Absolute Value}((I_{LED1} - I_{LED2}) / (I_{LED1} + I_{LED2})) \times 100$

Note 11: Current Accuracy = $\text{Absolute Value}(I_{TARGET} - (I_{LED1} + I_{LED2})) \times 100$

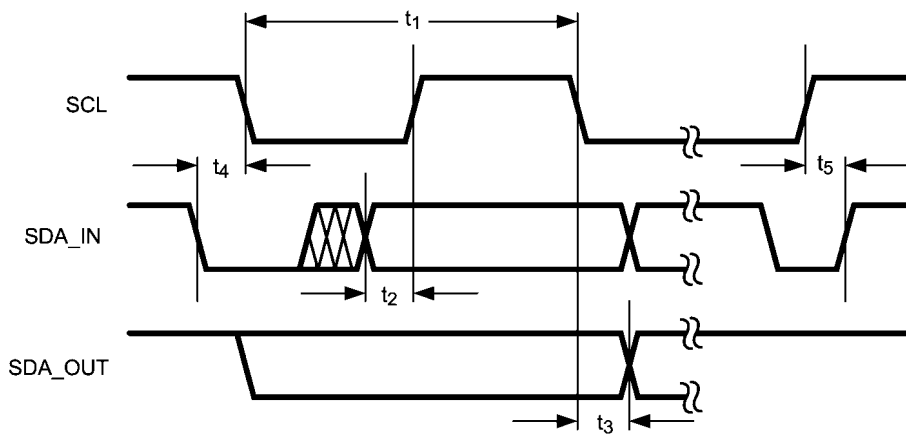

30042004

FIGURE 1. I²C Timing

Typical Performance Characteristics $V_{IN} = 3.6V$, LEDs are Lumiled PWF-4, $C_{OUT} = 10\mu F$, $C_{IN} = 4.7\mu F$, $L = FDSE0312-2R2$ ($2.2\mu H$, $R_L = 0.15\Omega$), $T_A = +25^\circ C$ unless otherwise specified.

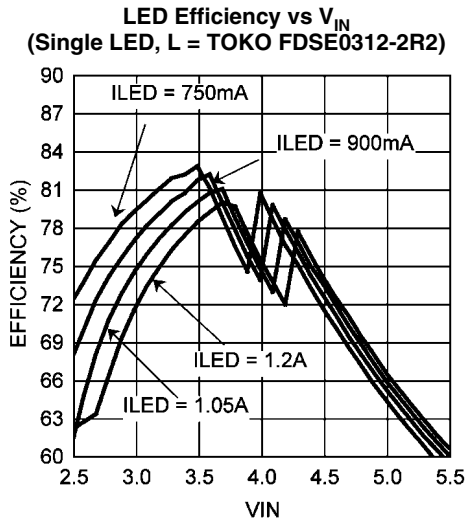

30042048

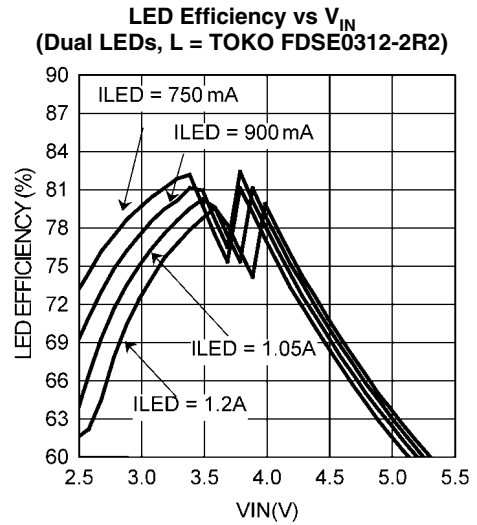

30042049

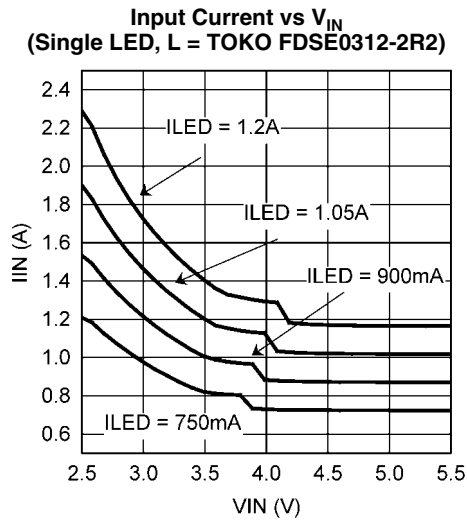

30042050

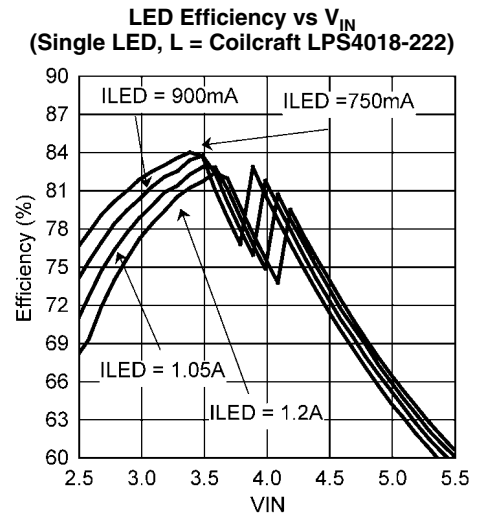

30042051

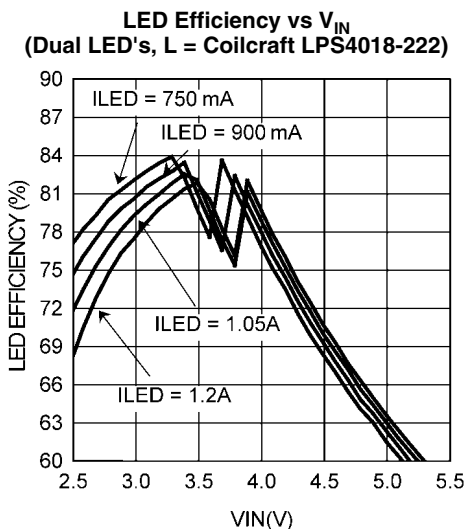

30042052

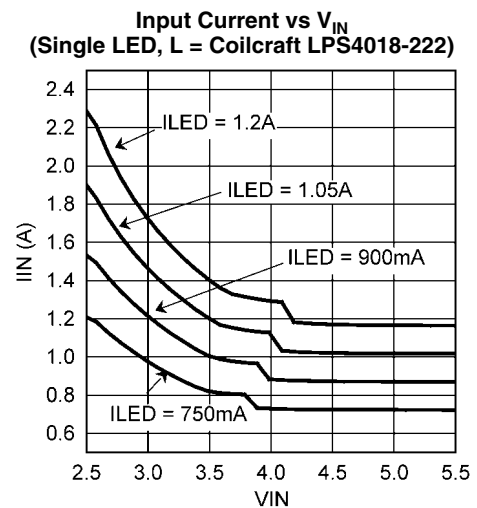

30042053

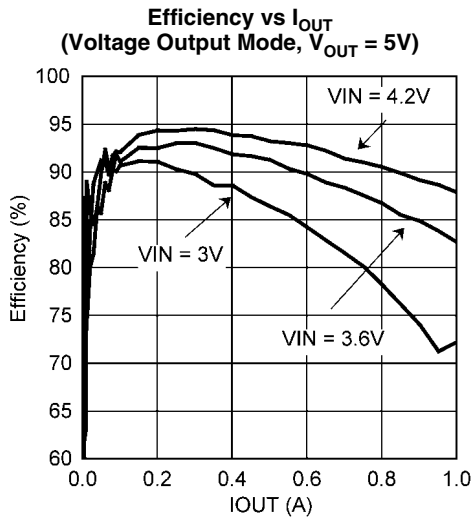

30042055

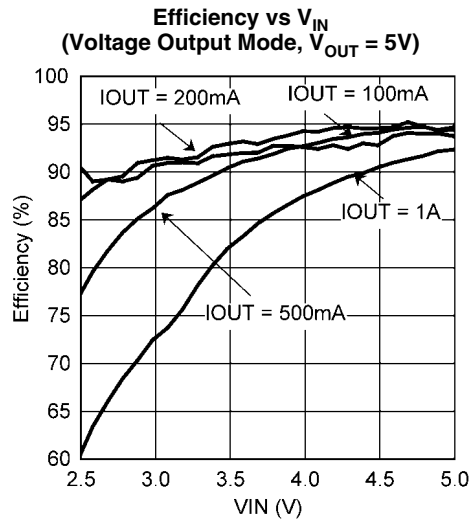

30042056

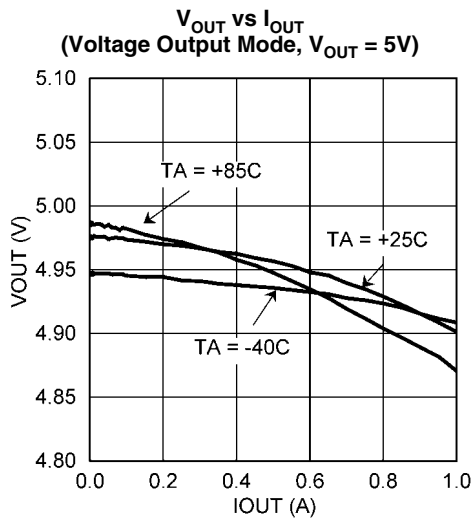

30042057

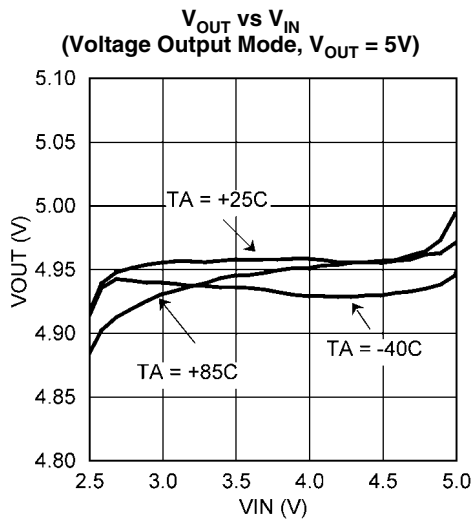

30042058

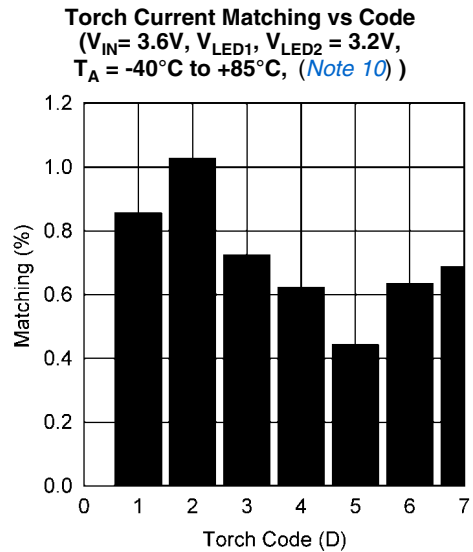

30042094

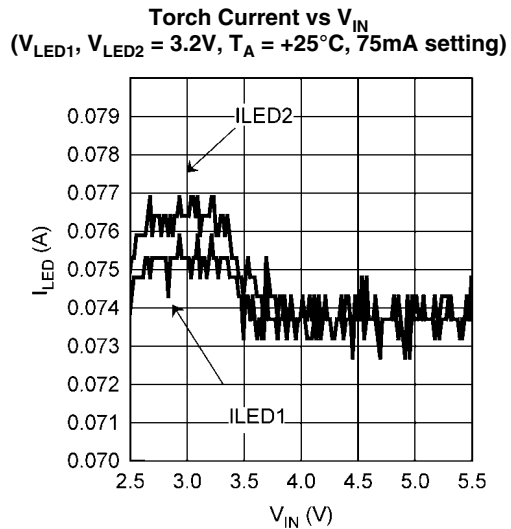

30042096

Torch Current vs V_{IN}
 ($V_{LED1}, V_{LED2} = 3.2V, T_A = +85^\circ C, 75mA$ setting)

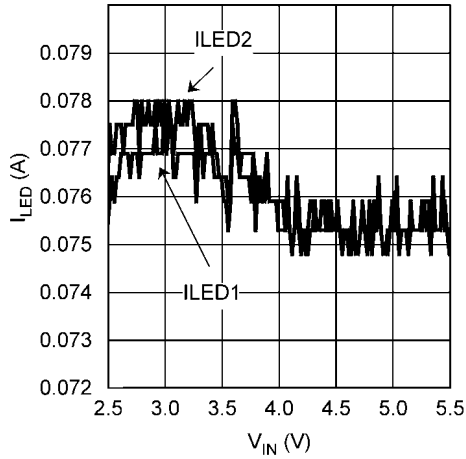

300420102

Torch Current vs V_{IN}
 ($V_{LED1}, V_{LED2} = 3.2V, T_A = -40^\circ C, 75mA$ setting)

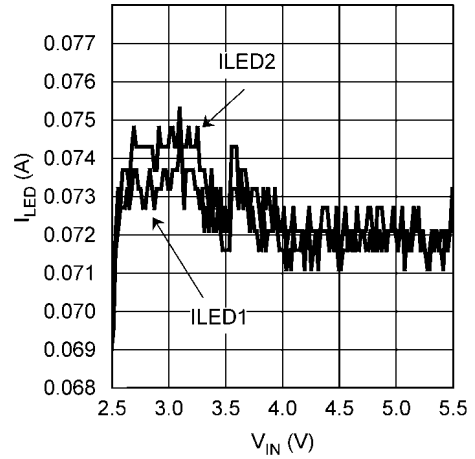

300420104

Flash Current Matching vs Code
 ($V_{IN} = 3.6V, V_{LED1}, V_{LED2} = 3.2V,$
 $T_A = -40^\circ C$ to $+85^\circ C,$ (Note 10))

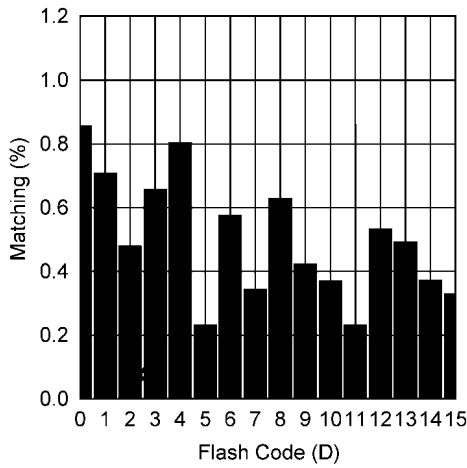

30042095

Flash Current vs V_{IN}
 ($V_{LED1}, V_{LED2} = 3.2V, T_A = +25^\circ C, 600mA$ setting)

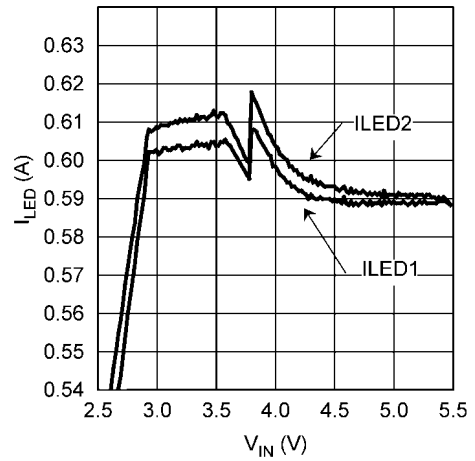

30042097

Flash Current vs V_{IN}
 ($V_{LED1}, V_{LED2} = 3.2V, T_A = +85^\circ C, 600mA$ setting)

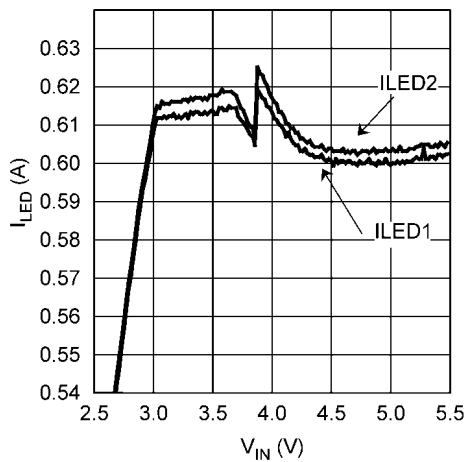

300420103

Flash Current vs V_{IN}
 ($V_{LED1}, V_{LED2} = 3.2V, T_A = -40^\circ C, 600mA$ setting)

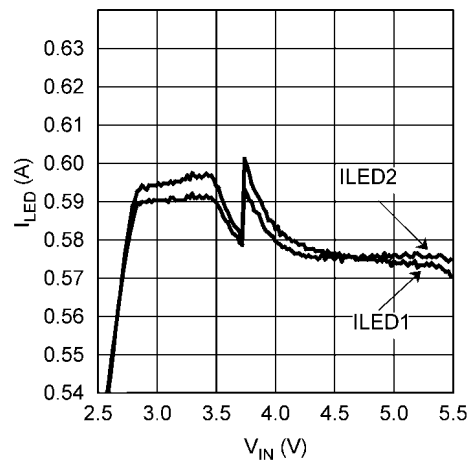

300420105

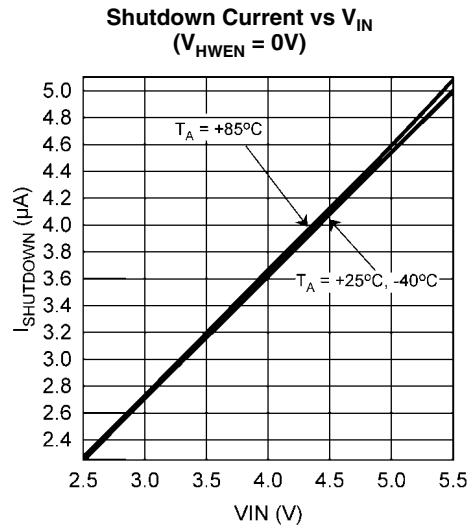
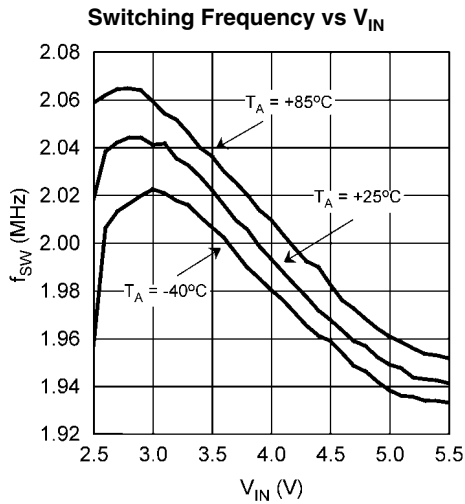

Active (Non-Switching) Supply Current vs V_{IN} ($V_{LED} = 1.5V$)

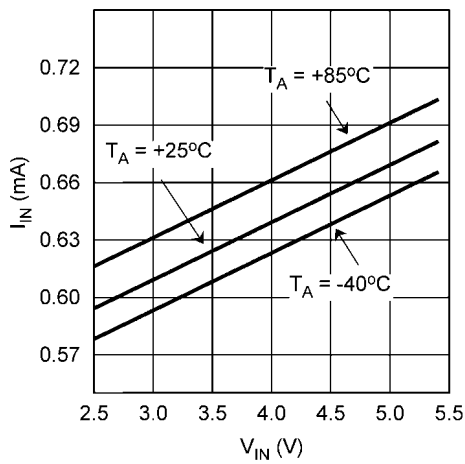

Active (Switching) Supply Current vs V_{IN} ($V_{OUT} = 5V, I_{OUT} = 400mA$)

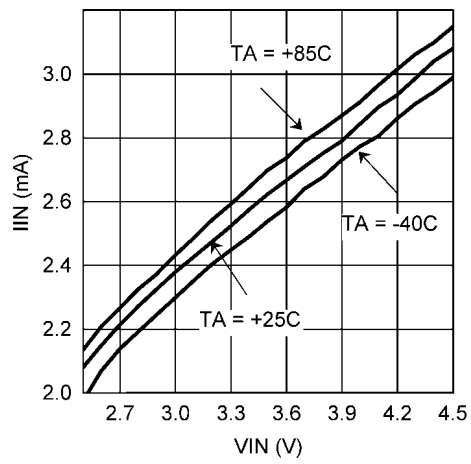

Closed Loop Current Limit vs V_{IN} (Flash Duration Register bits [6:5] = 00, (Note 8))

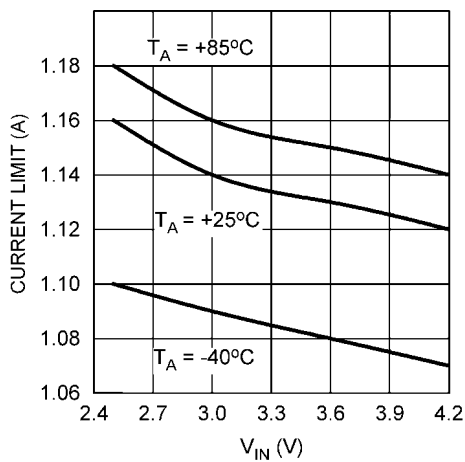

Closed Loop Current Limit vs V_{IN} (Flash Duration Register bits [6:5] = 01, (Note 8))

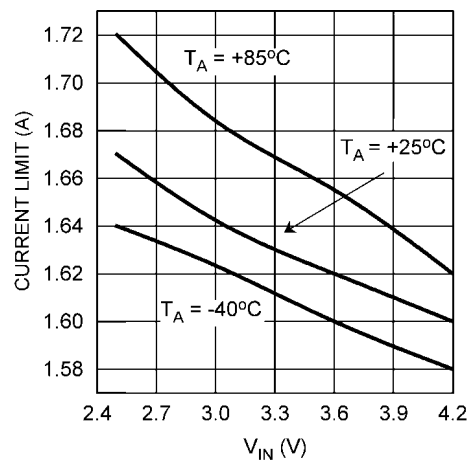

Closed Loop Current Limit vs V_{IN}
 (Flash Duration Register bits [6:5] = 10, (Note 8))

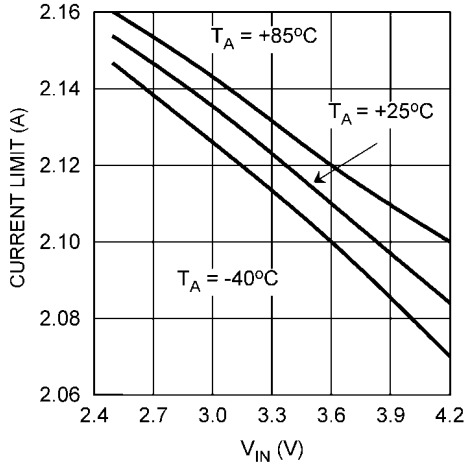

30042087

Closed Loop Current Limit vs V_{IN}
 (Flash Duration Register bits [6:5] = 11, (Note 8))

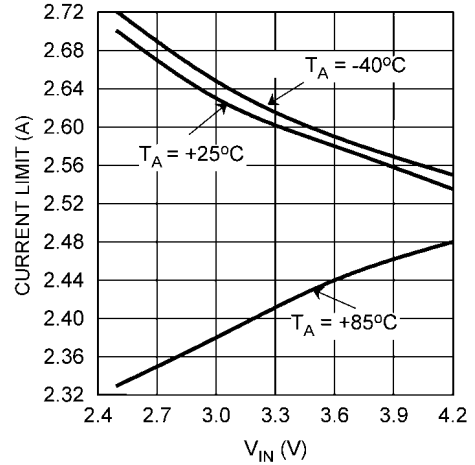

30042088

V_{IN} Monitor Thresholds vs Temperature

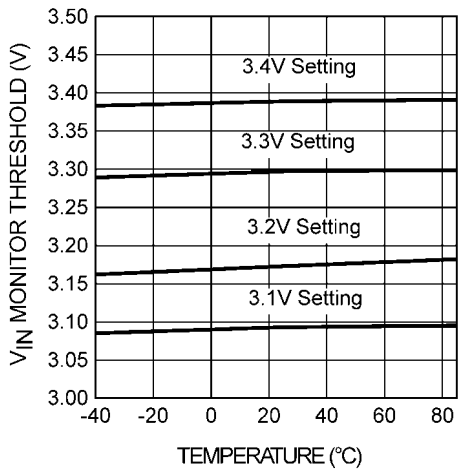

30042078

OVP Thresholds vs V_{IN}
 (Note 9)

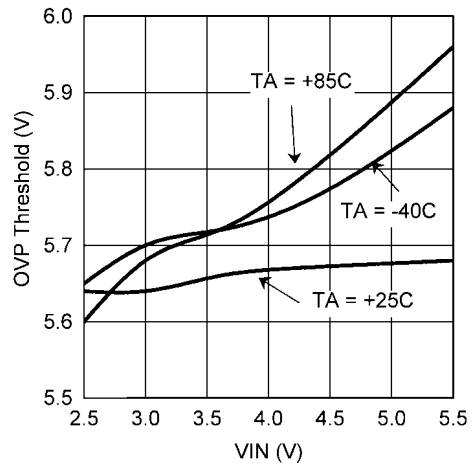

30042079

Short Circuit Current Limit vs V_{IN}

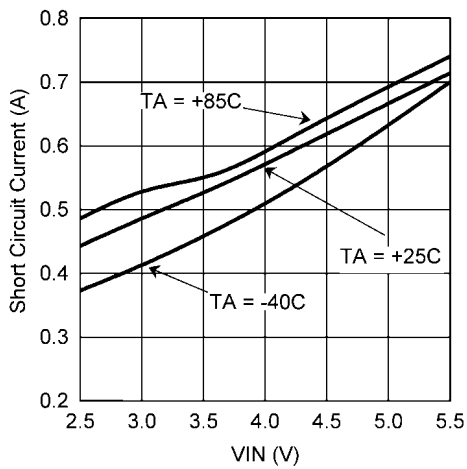

30042080

Indicator Current vs V_{IN} , $V_{LEDI} = 2V$
 (Torch Brightness Register bits [7:6] = 00)

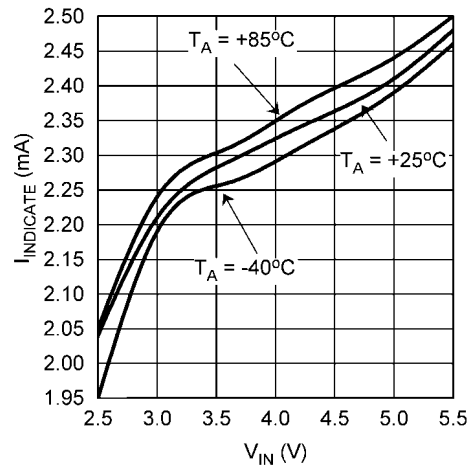

30042090

**Indicator Current vs V_{IN} , $V_{LED1} = 2V$
(Torch Brightness Register bits[7:6] = 01)**

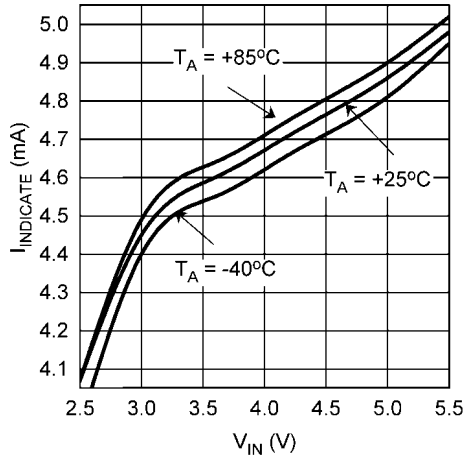

30042091

**Indicator Current vs V_{IN} , $V_{LED1} = 2V$
(Torch Brightness Register bits[7:6] = 10)**

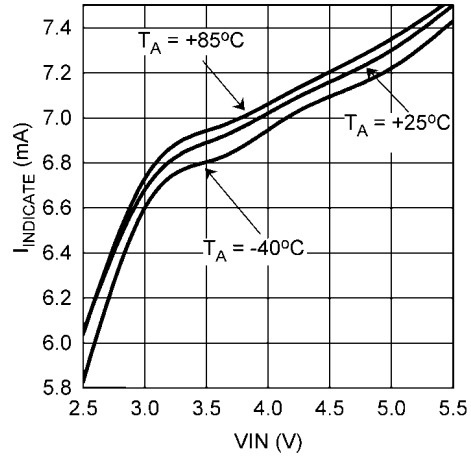

30042092

**Indicator Current vs V_{IN} , $V_{LED1} = 2V$
(Torch Brightness Register bits[7:6] = 11)**

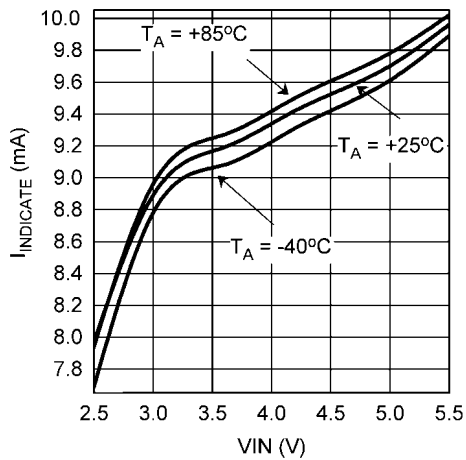

30042093

NTC Comparator Trip Threshold vs V_{IN}

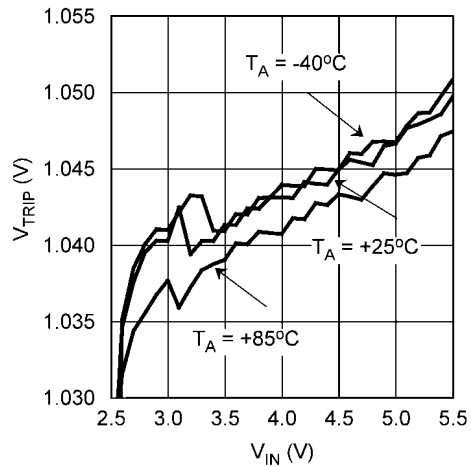

30042098

**Startup into Flash Mode
Single LED
 $I_{FLASH} = 1.2A$**

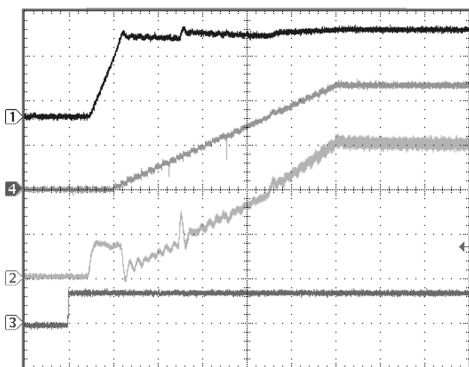

30042060

**Startup into Torch Mode
Single LED, Hardware Torch Mode, 90mA Torch Setting
 $I_{TORCH} = 180mA$**

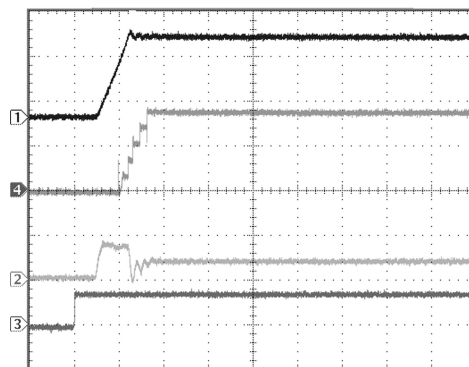

30042061

Channel 1: V_{OUT} (2V/div)
Channel 4: I_{LED} (500mA/div)
Channel 2: I_L (500mA/div)
Channel 3: STROBE (5V/div)
Time Base: (100 μ s/div)

Channel 1: V_{OUT} (2V/div)
Channel 4: I_{LED} (100mA/div)
Channel 2: I_L (500mA/div)
Channel 3: TX1 (5V/div)
Time Base: (100 μ s/div)

Torch Mode to Flash Mode Transition Single LED

$I_{TORCH} = 295\text{mA}$, $I_{FLASH} = 1.2\text{A}$

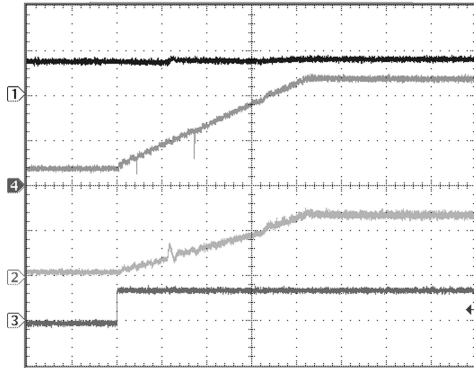

30042062

Channel 1: V_{OUT} (5V/div)
Channel 4: I_{LED} (500mA/div)
Channel 2: I_L (1A/div)
Channel 3: STROBE (5V/div)
Time Base: (100 μ s/div)

TX1 Interrupt Operation, TX1 Rising Single LED

$I_{FLASH} = 1.2\text{A}$, $I_{TORCH} = 180\text{mA}$

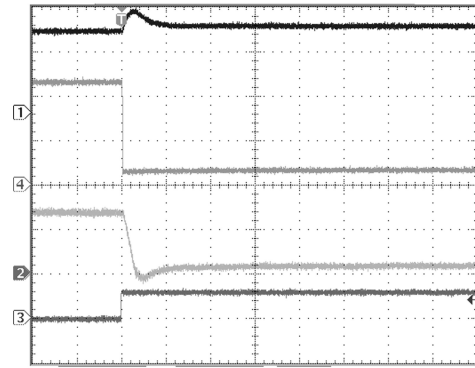

30042063

Channel 1: V_{OUT} (2V/div)
Channel 4: I_{LED} (500mA/div)
Channel 2: I_L (1A/div)
Channel 3: TX1 (5V/div)
Time Base: (20 μ s/div)

TX1 Interrupt Operation, TX1 Falling Single LED

$I_{FLASH} = 1.2\text{A}$, $I_{TORCH} = 180\text{mA}$

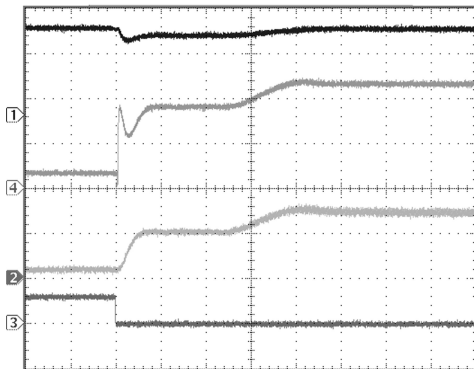

30042064

Channel 1: V_{OUT} (2V/div)
Channel 4: I_{LED} (500mA/div)
Channel 2: I_L (1A/div)
Channel 3: TX1 (5V/div)
Time Base: (20 μ s/div)

Line Transient (LED Mode, Single LED, $I_{FLASH} = 1.2\text{A}$)

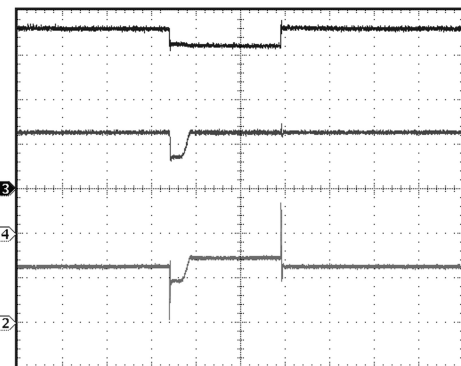

30042065

Channel 3: V_{IN} (1V/div)
Channel 4: I_{LED} (500mA/div)
Channel 2: I_L (1A/div)
Time Base: (400 μ s/div)

Load Transient
 $V_{IN} = 3.6V$
 (Voltage Output Mode, $V_{OUT} = 5V$)

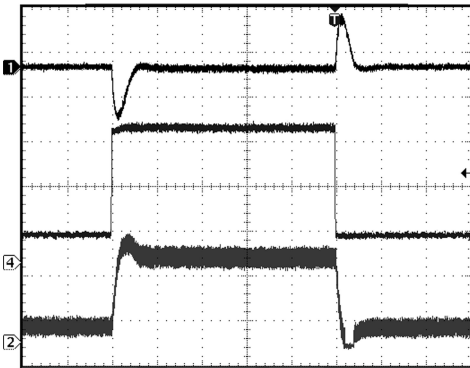

30042066

Channel 1: V_{OUT} (500mV/div, AC Coupled)
 Channel 4: I_{OUT} (200mA/div)
 Channel 2: I_L (500mA/div)
 Time Base: (40µs/div)

Line Transient
 $I_{OUT} = 500mA$
 (Voltage Output Mode, $V_{OUT} = 5V$)



30042067

Channel 3 (Top Trace): V_{IN} (1V/div)
 Channel 1: V_{OUT} (100mV/div, AC Coupled)
 Channel 2: $I_L + I_{IN}$ (500mA/div)
 Time Base: (200µs/div)

Flash Pulse to HWEN Low
 Single LED, $I_{LED} = 1.2A$

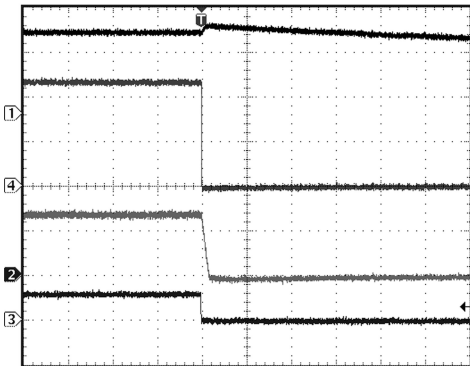

30042068

Channel 1: V_{OUT} (2V/div)
 Channel 4: I_{LED} (500mA/div)
 Channel 2: I_L (1A/div)
 Channel 3: HWEN (5V/div)
 Time Base: (20µs/div)

Flash Pulse to Flash Pulse + V_{OUT} Mode
 Single LED, $I_{LED} = 1.2A$, $V_{OUT} = 5V$

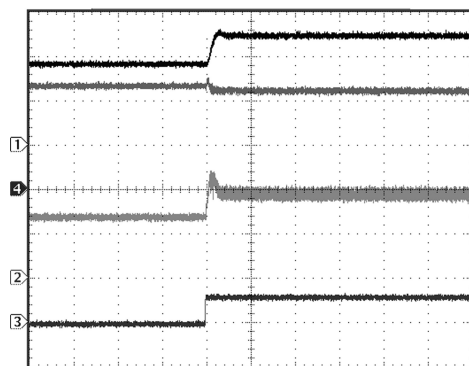

30042072

Channel 1: V_{OUT} (2V/div)
 Channel 4: I_{LED} (500mA/div)
 Channel 2: I_L (1A/div)
 Channel 3: ENVN (5V/div)
 Time Base: (100µs/div)

Flash Pulse + V_{OUT} to Flash Pulse Single LED, $I_{LED} = 1.2A$, $V_{OUT} = 5V$

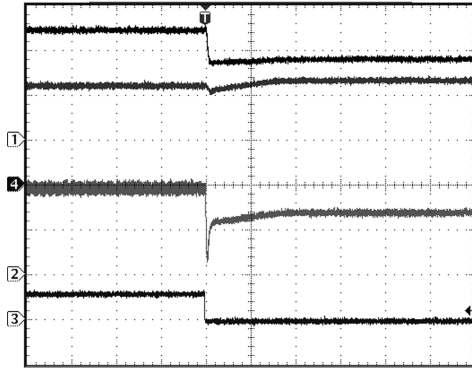

30042073

Channel 1: V_{OUT} (2V/div)
 Channel 4: I_{LED} (500mA/div)
 Channel 2: I_L (1A/div)
 Channel 3: ENVM (5V/div)
 Time Base: (100µs/div)

NTC Mode Response Single LED, $I_{LED} = 1.2A$ Circuit of [Figure 25](#) ($R(T) = 100k\Omega$ (@+25°C), $R3 = 9k\Omega$)

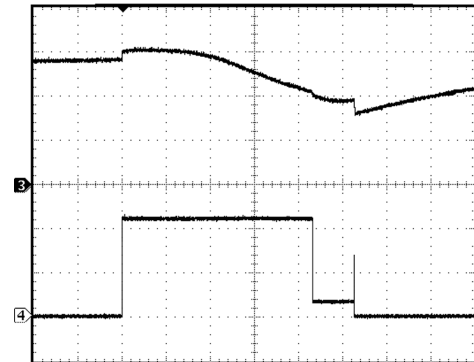

30042076

Channel 3: NTC Pin Voltage (500mV/div)
 Channel 4: I_{LED} (500mA/div)
 Time Base: (200ms/div)

V_{IN} Monitor Response Single LED, $I_{LED} = 1.2A$ 3.1V UVLO Setting

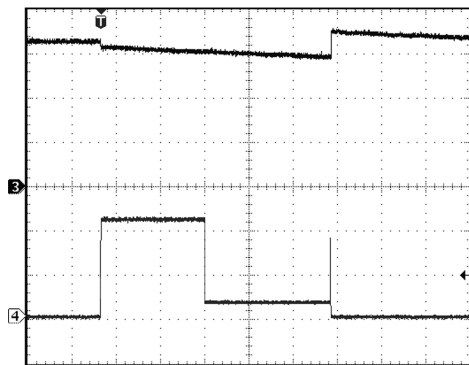

30042077

Channel 3: V_{IN} (1V/div)
 Channel 4: I_{LED} (500mA/div)
 Time Base: (100ms/div)

Block Diagram

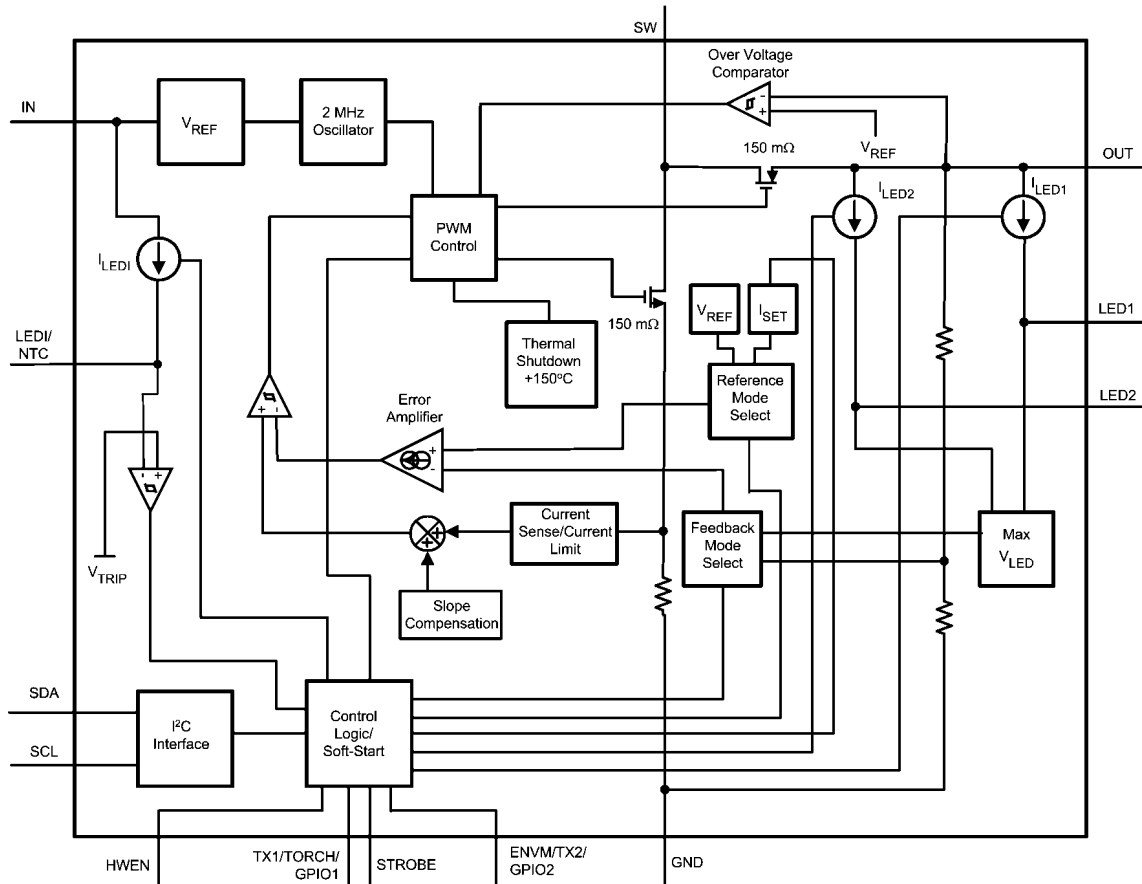

30042005

Overview

The LM3554 is a high-power white LED flash driver capable of delivering up to 1.2A of LED current into a single LED, or up to 600mA into two parallel LEDs. The device incorporates a 2MHz constant frequency, synchronous, current mode PWM boost converter, and two high-side current sources to regulate the LED current over the 2.5V to 5.5V input voltage range.

The LM3554 operates in two modes: LED mode or constant Voltage Output mode. In LED mode when the output voltage is greater than $V_{IN} - 150\text{mV}$, the PWM converter switches and maintains at least 300mV (V_{HR}) across both current sources (LED1 and LED2). This minimum headroom voltage ensures that the current sinks remain in regulation. When the input voltage is above $V_{LED} + V_{HR}$, the device operates in Pass mode with the device not switching and the PFET on continuously. In Pass mode the difference between $(V_{IN} - I_{LED} \times R_{ON,P})$ and V_{LED} is dropped across the current sources. If the device is operating in Pass mode, and V_{IN} drops to a point that forces the device into switching, the LM3554 will make a one-time decision to jump into switching mode. The LM3554 remains in switching mode until the device is shutdown and re-enabled. This is true even if V_{IN} were to rise back above $V_{LED} + 300\text{mV}$ during the current Flash or Torch cycle. This prevents the LED current from oscillating when V_{IN} is operating close to V_{OUT} .

In Voltage Output mode the LM3554 operates as a voltage output boost converter with selectable output voltages of 4.5V and 5V. In this mode the LM3554 is able to deliver up to typically 5W of output power. At light loads and in Voltage Output mode the PWM switching converter changes over to a pulsed frequency regulation mode and only switches as necessary to ensure proper LED current or output voltage regulation. This allows for improved light load efficiency compared to converters that operate in fixed-frequency PWM mode at all load currents.

Additional features of the LM3554 include 4 logic inputs, an internal comparator for LED thermal sensing, and a low-power indicator LED current source. The STROBE input provides a hardware Flash mode enable. The ENVM/TX2/GPIO2 input is configurable as a hardware Voltage Output mode enable (ENVM), an active high Flash interrupt that forces the device from FLASH mode to a low-power TORCH mode (TX2), or as a programmable logic input/output (GPIO2). The TX1 input is configurable as an active high Flash interrupt that forces the device from FLASH mode to a low-power TORCH mode (TX1), as a hardware Torch mode enable (TORCH), or as a programmable logic input/output (GPIO1). The HWEN input provides for an active low hardware shutdown of the device. Finally, the LEDI/NTC pin is configurable as a low-power indicator LED driver (LEDI), or as a threshold detector for thermal sensing (NTC). In NTC mode when the threshold (V_{TRIP}) at the LEDI/NTC pin is crossed ($V_{LEDI/NTC}$ falling), the

Flash pulse is forced to the Torch current setting, or into shutdown depending on the NTC Shutdown bit setting .

Control of the LM3554 is done via an I²C-compatible interface. This includes switch-over from LED to Voltage Output mode, adjustment of the LED current in TORCH mode, adjustment of the LED current in FLASH mode, adjustment of the indicator LED currents, changing the flash LED current duration, changing the switch current limit. Additionally, there are 5 flag bits that can be read back indicating flash current timeout, over-temperature condition, LED failure (open or short), LED thermal failure, and an input voltage fault.

STARTUP

Turn on of the LM3554 is done through bits [2:0] of the Torch Brightness Register (0xA0), bits [2:0] of the Flash Brightness Register (0xB0), the ENVM input, or the STROBE input. Bits [1:0] of the Torch Brightness Register or Flash Brightness Register enables/disables the current sources (LED1, LED2, and LEDI). Bit [2] enables/disables the voltage output mode. A logic high at STROBE enables Flash mode. A logic high on the ENVM input forces the LM3554 into Voltage Output mode.

On startup, when V_{OUT} is less than V_{IN} the internal synchronous PFET turns on as a current source and delivers typically 350mA to the output capacitor. During this time all current sources (LED1, LED2, and LEDI) are off. When the voltage across the output capacitor reaches 2.2V, the current sources can turn on. At turn-on the current sources step through each FLASH or TORCH level until the target LED current is reached (16 μ s/step). This gives the device a controlled turn-on and limits inrush current from the V_{IN} supply.

PASS MODE

Once the Output voltage charges up to $V_{IN} - 150\text{mV}$ the LM3554 will decide if the part operates in Pass Mode or Boost mode. If the voltage difference between V_{OUT} and V_{LED} is less than 300mV, the device will transition in Boost Mode. If the difference between V_{OUT} and V_{LED} is greater than 300mV, the device will operate in Pass Mode. In Pass Mode the boost converter stops switching, and the synchronous PFET turns fully on bringing V_{OUT} up to $V_{IN} - I_{IN} \times R_{PMOS}$ ($R_{PMOS} = 150\text{m}\Omega$). In Pass Mode the inductor current is not limited by the peak current limit. In this situation the output current must be limited to 2.5A.

LIGHT LOAD DISABLE

Configuration Register 1 bit [0] = 1 disables the light load comparator. With this bit set to 0 (default) the light load comparator is enabled. Light Load mode only applies when the LM3554 is active in Voltage Output mode. In LED mode the Light Load Comparator is always disabled. When the light

load comparator is disabled the LM3554 will operate at a constant frequency down to $I_{LOAD} = 0$. Disabling light load can be useful when a more predictable switching frequency across the entire load current range is desired.

VOLTAGE OUTPUT MODE

Bit 2 (VM) of the Torch Brightness Register, bit 2 (VM) of the Flash Brightness Register, or the ENVM input enables or disables the Voltage Output mode. In Voltage Output mode the device operates as a simple boost converter with two selectable voltage levels (4.5V and 5V). Write a (1) to bit 1 (OV) of Configuration Register 1 to set V_{OUT} to 5V. Write a (0) to this bit to set V_{OUT} to 4.5V. In Voltage Output mode the LED current sources can continue to operate; however, the difference between V_{OUT} and V_{LED} will be dropped across the current sources. (See [MAXIMUM OUTPUT POWER](#) section.) In Voltage Output mode when V_{IN} is greater than V_{OUT} the LM3554 operates in Pass Mode (see [PASS MODE](#) section).

At light loads the LM3554 switches over to a pulsed frequency mode operation (light load comparator enabled). In this mode the device will only switch as necessary to maintain V_{OUT} within regulation. This mode provides a better efficiency due to the reduction in switching losses which become a larger portion of the total power loss at light loads.

OVER-VOLTAGE PROTECTION

The output voltage is limited to typically 5.6V (5.7V max). In situations such as the current source open, the LM3554 will raise the output voltage in order to try and keep the LED current at its target value. When V_{OUT} reaches 5.6V the over-voltage comparator will trip and turn off both the internal NFET and PFET. When V_{OUT} falls below 5.4V (typical), the LM3554 will begin switching again.

CURRENT LIMIT

The LM3554 features 4 selectable current limits: 1A, 1.5A, 2A, and 2.5A. These are selectable through the I²C-compatible interface via bits 5 (CL0) and 6 (CL1) of the Flash Duration Register. When the current limit is reached, the LM3554 stops switching for the remainder of the switching cycle.

Since the current limit is sensed in the NMOS switch there is no mechanism to limit the current when the device operates in Pass Mode. In situations where there could potentially be large load currents at OUT, and the LM3554 is operating in Pass mode, the load current must be limited to 2.5A. In Boost mode or Pass mode if V_{OUT} falls below approximately 2.3V, the part stops switching, and the PFET operates as a current source limiting the current to typically 350mA. This prevents damage to the LM3554 and excessive current draw from the battery during output short circuit conditions.

MAXIMUM LOAD CURRENT (VOLTAGE MODE)

Assuming the power dissipation in the LM3554 and the ambient temperature are such that the device will not hit thermal shutdown, the maximum load current as a function of I_{PEAK} is:

$$I_{LOAD} = \frac{(I_{PEAK} - \Delta I_L) \times \eta \times V_{IN}}{V_{OUT}}$$

Where η is efficiency and is found in the efficiency curves in the Typical Performance Characteristics and

$$\Delta I_L = \frac{V_{IN} \times (V_{OUT} - V_{IN})}{2 \times f_{SW} \times L \times V_{OUT}}$$

Figure 2 shows the theoretical maximum Output current vs theoretical Efficiency at different input and output voltages using the previous two equations for ΔI_L and I_{LOAD} with a peak current of 2.5A. This plot represents the theoretical maximum output current (for the LM3554 in Voltage Output mode) that the device can deliver just before hitting current limit.

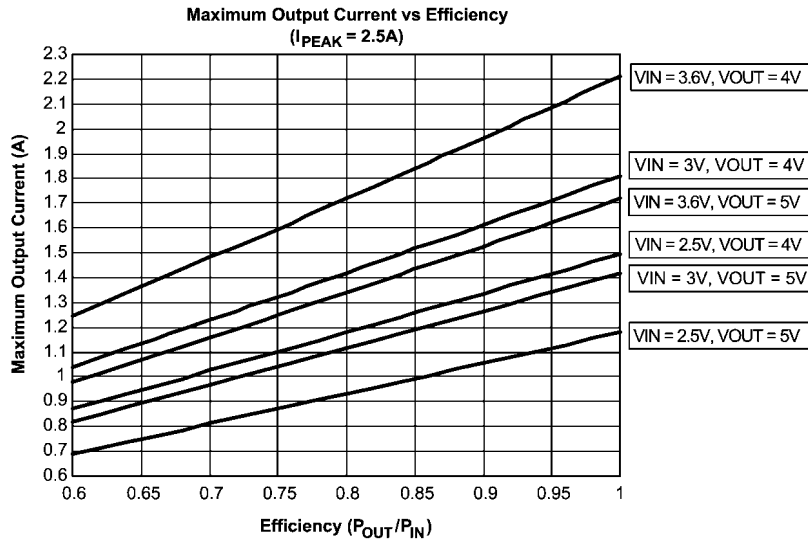

FIGURE 2. LM3554 Maximum Output Current

MAXIMUM OUTPUT POWER

Output power is limited by three things: the peak current limit, the ambient temperature, and the maximum power dissipation in the package. If the LM3554's die temperature is below the absolute maximum rating of +125°C, the maximum output power can be over 6W. However, any appreciable output current will cause the internal power dissipation to increase and

Maximum Output Power (Voltage Output Mode)

In Voltage Output mode the total power dissipated in the LM3554 can be approximated as:

$$P_{DISS} = P_N + P_P + P_{LED1} + P_{LED2} + P_{IND}$$

$$P_{DISS} = \left[\left(\frac{(V_{OUT} - V_{IN}) \times V_{OUT}}{V_{IN}^2} \right) \times I_{LOAD}^2 \times R_{NFET} + \left(\frac{V_{OUT}}{V_{IN}} \right) \times I_{LOAD}^2 \times R_{PFET} + (V_{OUT} - V_{LED}) \times I_{LED} + (V_{OUT} - V_{IND}) \times I_{IND} \right]$$

$$I_{LOAD} = I_{OUT} + I_{LED} + I_{IND}$$

$$I_{LED} = I_{LED1} + I_{LED2}$$

30042010

The above formulas consider the average current through the NFET and PFET. The actual power losses will be higher due

therefore increase the die temperature. This can be additionally compounded if the LED current sources are operating while the device is in Voltage Output mode since the difference between V_{OUT} and V_{LED} is dropped across the current sources. Any circuit configuration must ensure that the die temperature remains below +125°C taking into account the ambient temperature derating.

P_N is the power lost in the NFET, P_P is the PFET power loss, P_{LED1} , P_{LED2} , and P_{IND} are the losses across the current sinks. An approximate calculation of these losses gives:

to the RMS currents and the quiescent power into IN. These, however, can give a decent approximation.

Maximum Output Power (Led Boost Mode)

In LED mode with $V_{OUT} > V_{IN}$ the LM3554's boost converter will switch and make $V_{OUT} = V_{LED} + 0.3V$. In this situation the total power dissipated in the LM3554 is approximated as:

$$P_{DISS} = \left[\left(\frac{(V_{LED} + 0.3V - V_{IN}) \times V_{LED} + 0.3V}{V_{IN}^2} \right) \times I_{LOAD}^2 \times R_{NFET} + \left(\frac{V_{LED} + 0.3V}{V_{IN}} \right) \times I_{LOAD}^2 \times R_{PFET} + 0.3V \times I_{LED} + (V_{LED} + 0.3V - V_{IND}) \times I_{IND} \right]$$

$$I_{LOAD} = I_{LED} + I_{IND}$$

$$I_{LED} = I_{LED1} + I_{LED2}$$

Equation 1

30042011

Maximum Output Power (Led Pass Mode)

In LED mode with $V_{IN} - I_{LOAD} \times R_{PFET} > V_{LED} + 0.3V$, the LM3554 operates in Pass Mode. In this case, the NFET is off,

and the PFET is fully on. The difference between $V_{IN} - I_{LOAD} \times R_{PMOS}$ and V_{LED} will be dropped across the current sources. In this situation the total power dissipated in the LM3554 is approximated as:

$$P_{DISS} = [I_{LOAD}^2 \times R_{PFET} + (V_{IN} - R_{PFET} \times I_{LOAD} - V_{LED}) \times I_{LED} + (V_{IN} - R_{PFET} \times I_{LOAD} - V_{IND}) \times I_{IND}]$$

$$I_{LOAD} = I_{LED} + I_{IND}$$

$$I_{LED} = I_{LED1} + I_{LED2}$$

Equation 2

30042012

Once the total power dissipated in the LM3554 is calculated the ambient temperature and the thermal resistance of the 16-bump micro SMD (TMD16) are used to calculate the total die temperature (or junction temperature T_J).

As an example, assume the LM3554 is operating at $V_{IN} = 3.6V$ and configured for Voltage Output mode with $V_{OUT} = 5V$ and $I_{OUT} = 0.7A$. The LED currents are then programmed in Torch mode with 150mA each at $V_{LED} = 3.6V$. Additionally, the indicator LED has 10mA at $V_{IND} = 3.6V$. Using Equations 1 and 2 above, the approximate total power dissipated in the device is:

$$P_{DISS} = 139 \text{ mW} + 357 \text{ mW} + 420 \text{ mW} + 14 \text{ mW} = 930 \text{ mW}$$

The die temperature approximation will be:

$$T_J = 0.93W \times 60^\circ \frac{C}{W} + 25^\circ C = 80.8^\circ C.$$

In this case the device can operate at these conditions. If then the ambient temperature is increased to $+85^\circ C$, the die temperature would be $+140.8^\circ C$; thus, the die temperature would

be above the absolute maximum ratings, and the load current would need to be scaled back. This example demonstrates the steps required to estimate the amount of current derating based upon operating mode, circuit parameters, and the device's junction-to-ambient thermal resistance. In this example a thermal resistance of $60^\circ C/W$ was used (JE51-7 standard). Since thermal resistance from junction-to-ambient is largely PCB layout dependent, the actual number used will likely be different and must be taken into account when performing these calculations.

FLASH MODE

In Flash mode the LED current sources (LED1 and LED2) each provide 16 different current levels from typically 34mA to approximately 600mA. The Flash currents are set by writing to bits [6:3] of the Flash Brightness Resister. Flash mode is activated by either writing a (1, 1) to bits [1:0] of the Torch Brightness Register, writing a (1,1) to bit [1:0] of the Flash Brightness Register, or by pulling the STROBE pin high. Once the Flash sequence is activated, both current sinks (LED1 and LED2) will ramp up to the programmed Flash current by stepping through all Flash levels ($16\mu s/step$) until the programmed current is reached.

FLASH TERMINATION (STROBE-INITIATED FLASH)

Bit [7] of the Flash Brightness Register (STR bit) determines how the Flash pulse terminates with STROBE-initiated flash pulses. With the STR bit = 1 the Flash current pulse will only terminate by reaching the end of the Flash Timeout period. With STR = 0, Flash mode can be terminated by pulling STROBE low, or by allowing the Flash Timeout period to elapse. If STR = 0 and STROBE is toggled before the end of the Flash Timeout period, the Timeout period resets on the rising edge of STROBE. See [LM3554 TIMING DIAGRAMS](#) regarding the Flash pulse termination for the different STR bit settings.

After the Flash pulse terminates, either by a flash timeout, or pulling STROBE low, LED1 and LED2 turn completely off. This happens even when Torch is enabled via the I²C-compatible interface, and the Flash pulse is turned on by toggling STROBE. After a Flash event ends the EN1, EN0 bits (bits [1:0] of the Torch Brightness Register, or Flash Brightness Register) are automatically re-written with (0, 0).

FLASH TERMINATION (I²C-INITIATED FLASH)

For I²C initiated flash pulses, the flash LED current can be terminated by either waiting for the timeout duration to expire or by writing a (0, 0) to bits [1:0] of the Torch Brightness Register, or Flash Brightness Register. If the timeout duration is allowed to elapse, the flash enable bits of the Torch Brightness and Flash Brightness Registers are automatically reset to 0.

FLASH TIMEOUT

The Flash Timeout period sets the duration of the flash current pulse. Bits [4:0] of the Flash Duration Register programs the 32 different Flash Timeout levels in steps of 32ms giving a Flash Timeout range of 32ms to 1024ms (see [Table 7](#)).

TORCH MODE

In Torch mode the current sources LED1 and LED2 each provide 8 different current levels (see [Table 2](#)). The Torch currents are adjusted by writing to bits [5:3] of the Torch Brightness Register. Torch mode is activated by setting Torch Brightness Register bits [1:0] to (1, 0) or Flash Brightness bits [1:0] to (1, 0). Once the Torch mode is enabled the current sources will ramp up to the programmed Torch current level by stepping through all of the Torch currents at 16μs/step until the programmed Torch current level is reached.

TX1/TORCH

The TX1/TORCH/GPIO1 input has a triple function. With Configuration Register 1 Bit [7] = 0 (default), TX1/TORCH/GPIO1 is a Power Amplifier Synchronization input (TX1 mode). This is designed to reduce the current pulled from the battery during an RF power amplifier transmit event. When the LM3554 is engaged in a Flash event, and the TX1 pin is pulled high, both LED1 and LED2 are forced into Torch mode at the programmed Torch current setting. If the TX1 pin is then pulled low before the Flash pulse terminates the LED current will ramp back to the previous Flash current level. At the end of the Flash timeout whether the TX1 pin is high or low, the LED current will turn off.

With the Configuration Register Bit [7] = 1, TX1/TORCH/GPIO1 is configured as a hardware Torch mode enable (TORCH). In this mode a high at TORCH turns on the LED current sources in Torch mode. STROBE (or I²C-initiated flash) will take precedence over the TORCH mode input. [Figure 12](#) details the functionality of the hardware TORCH mode. Additionally, when a flash pulse is initiated during hardware TORCH mode, the hardware torch mode bit is reset at the end

of the flash pulse. In order to re-enter hardware Torch mode, bit [7] of Configuration Register 1 would have to be re-written with a 1.

The TX1/TORCH/GPIO1 input can also be configured as a GPIO input/output. For details on this, refer to the [GPIO REG-ISTER](#) section of the datasheet.

ENVM/TX2/GPIO2

The ENVM/TX2/GPIO2/INT pin has four functions. In ENVM mode (Configuration Register 1 bit [5] = 0), the ENVM/TX2/GPIO2/INT pin is an active high logic input that forces the LM3554 into Voltage Output Mode. In TX2 mode (Configuration Register 1 bit [5] = 1), the ENVM/TX2/GPIO2/INT pin is a Power Amplifier Synchronization input that forces the LM3554 from Flash mode into Torch mode. In GPIO2 mode (GPIO Register Bit [3] = 1) the ENVM/TX2/GPIO2/INT pin is configured as a general purpose logic input/output and controlled via bits[3:5] of the GPIO Register. In INT mode the ENVM/TX2/GPIO2/INT pin is a hardware interrupt output which pulls low when the LM3554 is in NTC mode, and the voltage at LED1/NTC falls below V_{TRIP} .

In TX2 mode, when Configuration Register 1 bit [6] = 0 the ENVM/TX2/GPIO2 pin is an active low transmit interrupt input. Under this condition, when the LM3554 is engaged in a Flash event, and ENVM/TX2/GPIO2 is pulled low, both LED1 and LED2 are forced into either Torch mode or LED shutdown depending on the logic state of Configuration Register 2 bit [0]. In TX2 mode with Configuration Register 1 bit [6] = 1, the ENVM/TX2/GPIO2 pin is an active high transmit interrupt. Under this condition when the LM3554 is engaged in a Flash event, and the TX2 pin is driven high, both LED1 and LED2 are forced into Torch mode or LED shutdown, depending on the logic state of Configuration Register 2 bit [0]. After a TX2 event, if the ENVM/TX2/GPIO2 pin is disengaged, and the TX2 Shutdown bit is set to force Torch mode, the LED current will ramp back to the previous Flash current level. If the TX2 shutdown bit is programmed to force LED shutdown upon a TX2 event the Flags Register must be read to resume normal LED operation. [Table 2](#), [Figure 8](#) and [Figure 9](#) detail the functionality of the ENVM/TX2 input.

ENVM/TX2/GPIO2/INT as an Interrupt Output

In GPIO2 mode the ENVM/TX2/GPIO2 pin can be made to reflect the inverse of the LED Thermal Fault flag (bit[5] in the Flags Register). Configure the LM3554 for this feature by:

- set GPIO Register Bit [6] = 1 (NTC External Flag)
- set GPIO Register Bit [3] = 1 (GPIO2 mode)
- set GPIO Register Bit [4] = 1 (GPIO2 is an output)
- set Configuration Register 1 Bit [3] = 1 (NTC mode)

When the voltage at the LED1/NTC pin falls below V_{TRIP} (1.05V typical), the LED Thermal Fault Flag (bit [5] in the Flags Register) is set, and the ENVM/TX2/GPIO2/INT pin is forced low. In this mode the interrupt can only be reset to the open-drain state by reading back the Flags register.

INDICATOR LED/THERMISTOR (LED1/NTC)

The LED1/NTC pin serves a dual function, either as an LED indicator driver or as a threshold detector for a negative temperature coefficient (NTC) thermistor.

Led Indicator Mode (LED1)

LED1/NTC is configured as an LED indicator driver by setting Configuration Register 1 bit [3] = (0) and Torch Brightness Register bits [1:0] = (0, 1), or Flash Brightness Register bits [1:0] = (0, 1). In Indicator mode there are 4 different current levels available (2.3mA, 4.6mA, 6.9mA, 8.2mA). Bits [7:6] of

the Torch Brightness Register set the 4 different indicator current levels. The LED1 current source has a 1V typical headroom voltage.

Thermal Comparator Mode (NTC)

Writing a (1) to Configuration Register 1 bit [3] disables the indicator current source and configures the LED1/NTC pin as a detector for an NTC thermistor. In this mode LED1/NTC becomes the negative input of an internal comparator with the positive input internally connected to a reference ($V_{TRIP} = 1.05V$ typical). Additionally, Configuration Register 2 bit [1] determines the action the device takes if the voltage at LED1/NTC falls below V_{TRIP} (while the device is in NTC mode). With Configuration register 2 bit [1] = 0, the LM3554 will be forced into Torch mode when the voltage at LED1/NTC falls below V_{TRIP} . With Configuration Register 2 bit [1] = 1 the device will shut down the current sources when $V_{LED1/NTC}$ falls below V_{TRIP} . When the LM3554 is forced from Flash into Torch (by $V_{LED1/NTC}$ falling below V_{TRIP}), normal LED operation (during the same Flash pulse) can only be re-started by reading from the Flags Register (0xD0) **and** ensuring the voltage at $V_{LED1/NTC}$ is above V_{TRIP} . When $V_{LED1/NTC}$ falls below V_{TRIP} , and the Flags register is cleared, the LM3554 will go through a 250 μ s deglitch time before the flash current falls to either torch mode or goes into shutdown.

ALTERNATIVE EXTERNAL TORCH (AET MODE)

Configuration Register 2 bit [2] programs the LM3554 for Alternative External Torch mode. With this bit set to (0) (default) TX1/TORCH is a transmit interrupt that forces Torch mode only during a Flash event. For example, if TX1/TORCH goes high during a Flash event then the LEDs will be forced into

Torch mode only for the duration of the timeout counter. At the end of the timeout counter the LEDs will turn off.

With Configuration Register 2 bit [2] set to (1) the operation of TX1/TORCH becomes dependent on its occurrence relative to STROBE. In this mode if TX1/TORCH goes high first, then STROBE goes high, the LEDs are forced into Torch mode with no timeout. In this mode if TX1/TORCH goes high after STROBE has gone high then the TX1/TORCH pin operates as a normal TX interrupt, and the LEDs will turn off at the end of the timeout duration. (See [LM3554 TIMING DIAGRAMS](#), [Figure 10](#), and [Figure 11](#).)

INPUT VOLTAGE MONITOR

The LM3554 has an internal comparator that monitors the voltage at IN and can force the LED current into Torch mode or into shutdown if V_{IN} falls below the programmable VIN Monitor Threshold. Bit 0 in the VIN Monitor register (0x80) enables or disables this feature. When enabled, Bits 1 and 2 program the 4 adjustable thresholds of 3.1V, 3.2V, 3.3V, and 3.4V. Bit 3 in Configuration Register 2 (0xF0) selects whether an under-voltage event forces Torch mode or forces the LEDs off. See [Figure 21/ Table 7](#) and [Figure 23/ Table 9](#) for additional information.

There is a set 100mV hysteresis for the input voltage monitor. When the input voltage monitor is active, and V_{IN} falls below the programmed VIN Monitor Threshold, the LEDs will either turn off or their current will get reduced to the programmed Torch current setting. To reset the LED current to its previous level, two things must occur. First, V_{IN} must go at least 100mV above the UVLO threshold and secondly, the Flags register must be read back.

LM3554 TIMING DIAGRAMS

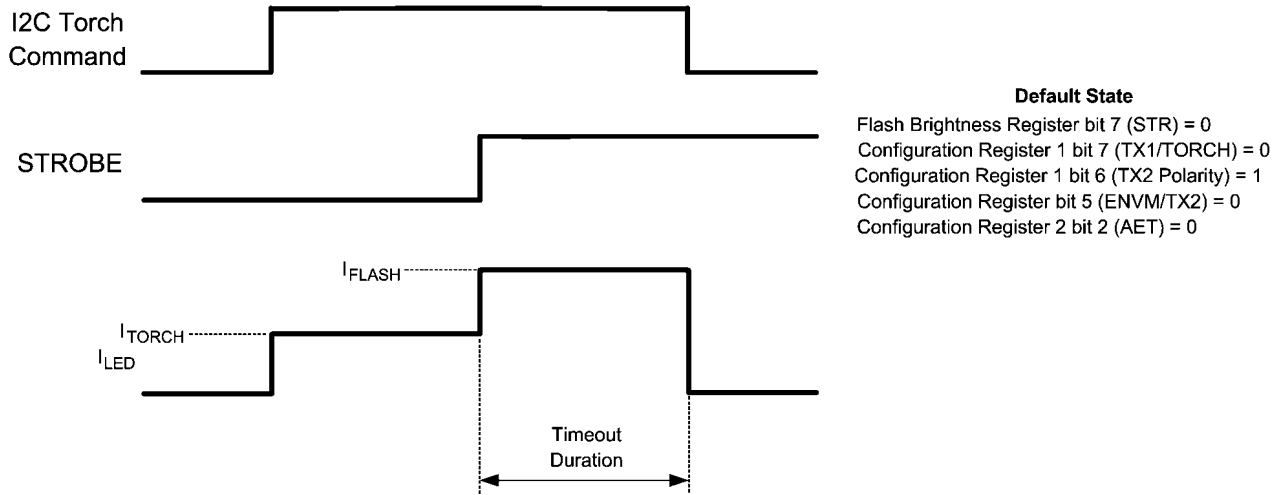

FIGURE 3. Normal Torch to Flash Operation (Default, Power On or RESET state of LM3554)

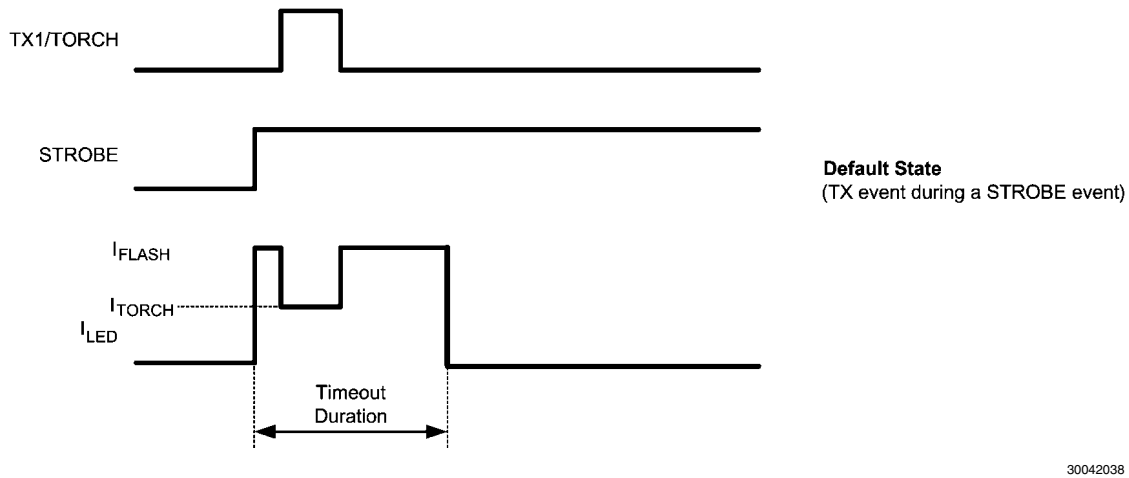

FIGURE 4. TX1 Event During a Flash Event (Default State, TX1/TORCH is an Active High TX Input)

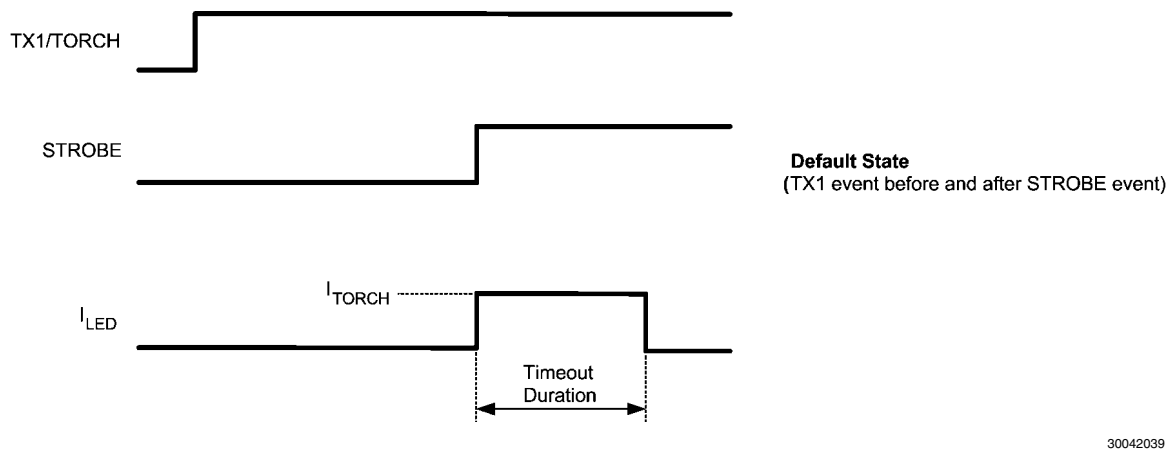
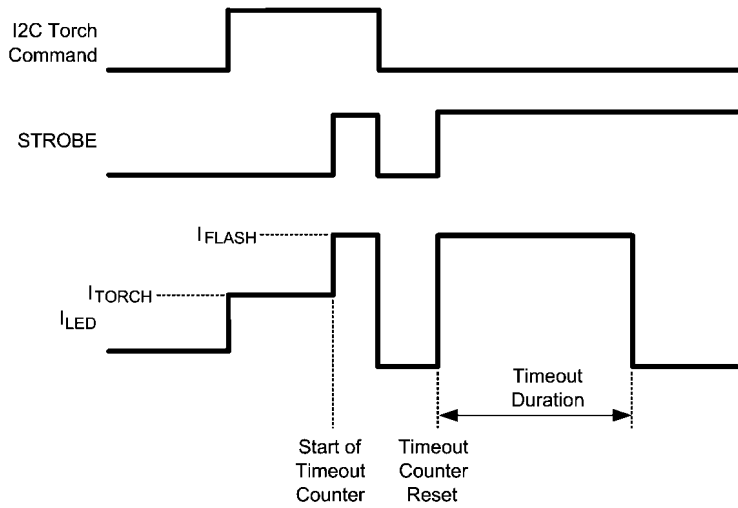

FIGURE 5. TX1 Event Before and After Flash Event (Default State, TX1/TORCH is an Active High TX Input)

**Default State**

STROBE goes high and the LEDs turn on into Flash mode. LEDs will turn off at the end of timeout duration or when STROBE goes low. Everytime STROBE goes high the timeout resets.

30042040

FIGURE 6. STROBE Input is Level Sensitive (Default State, STR bit = 0)

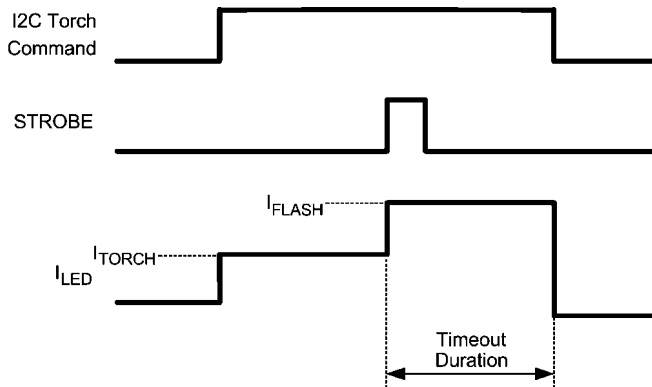
**Flash Brightness Register bit 7 (STR) = 1**

STROBE goes high and the LEDs turn on into Flash mode. LEDs will stay on for the timeout duration even if STROBE goes low before.

30042041

FIGURE 7. STROBE Input is Edge Sensitive (STR bit = 1)

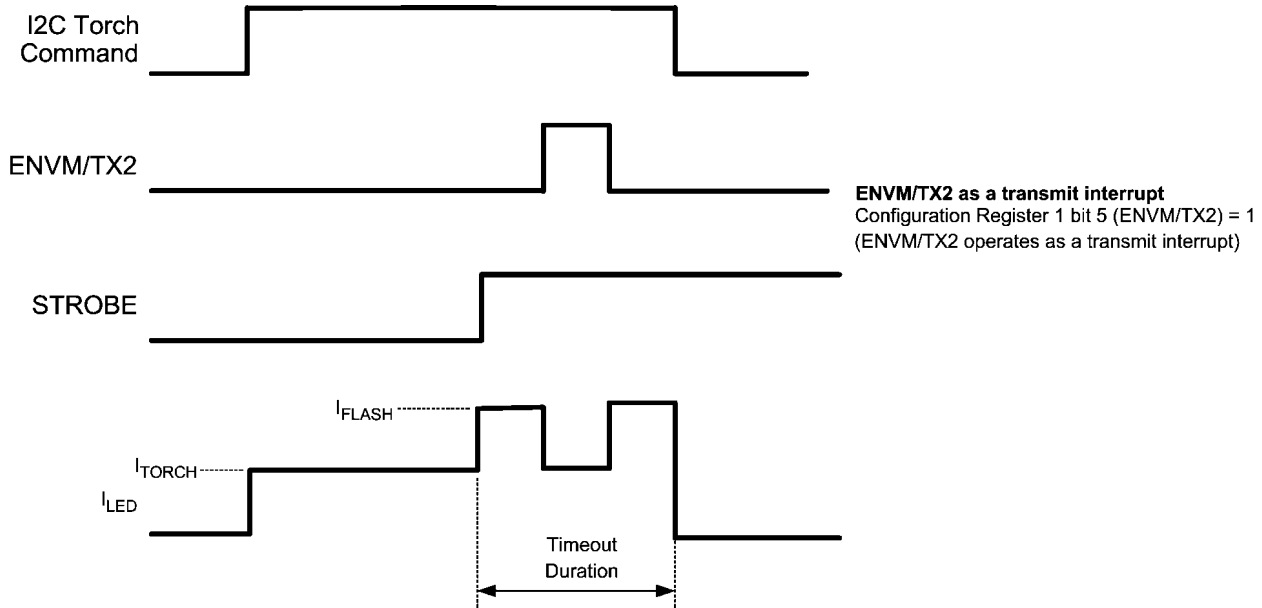

30042042

FIGURE 8. ENVM/TX2 Pin is Configured as an Active High TX Input

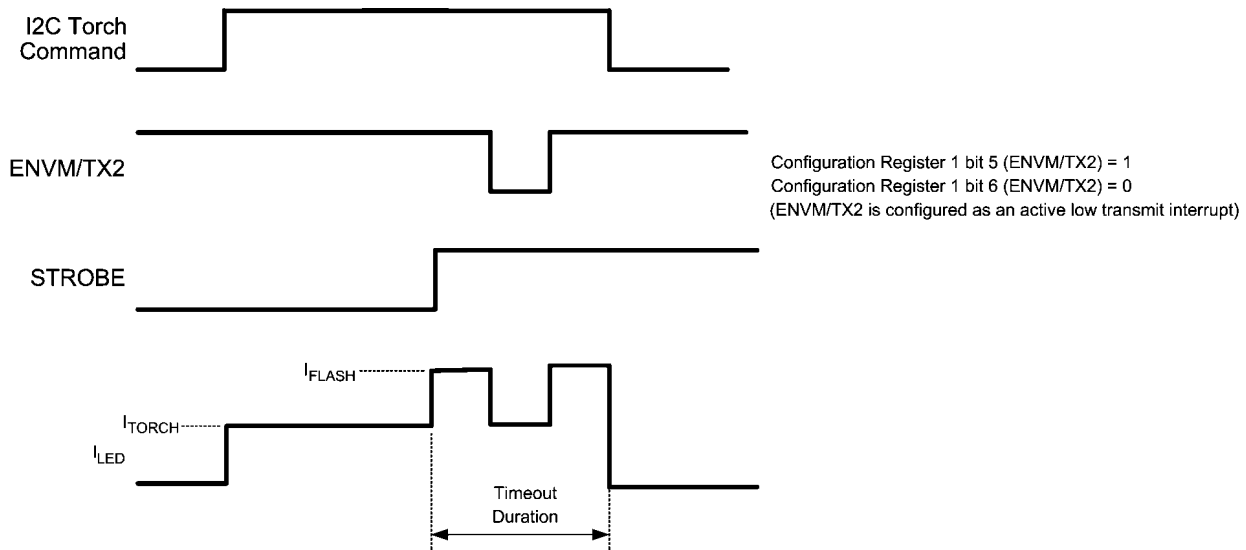

30042043

FIGURE 9. ENVM/TX2 Pin is Configured as an Active Low TX Input

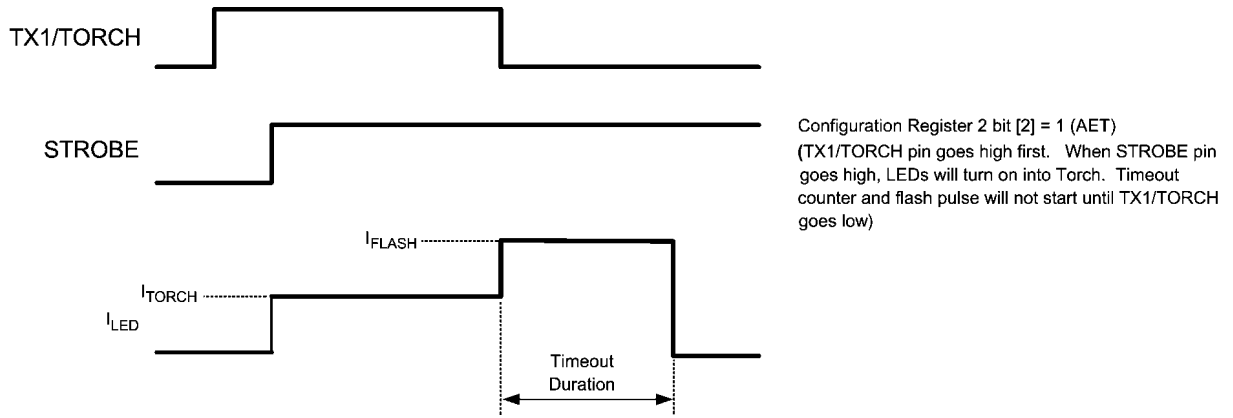

30042044

FIGURE 10. Alternative External Torch Mode (TX1/TORCH Turns on Before STROBE)

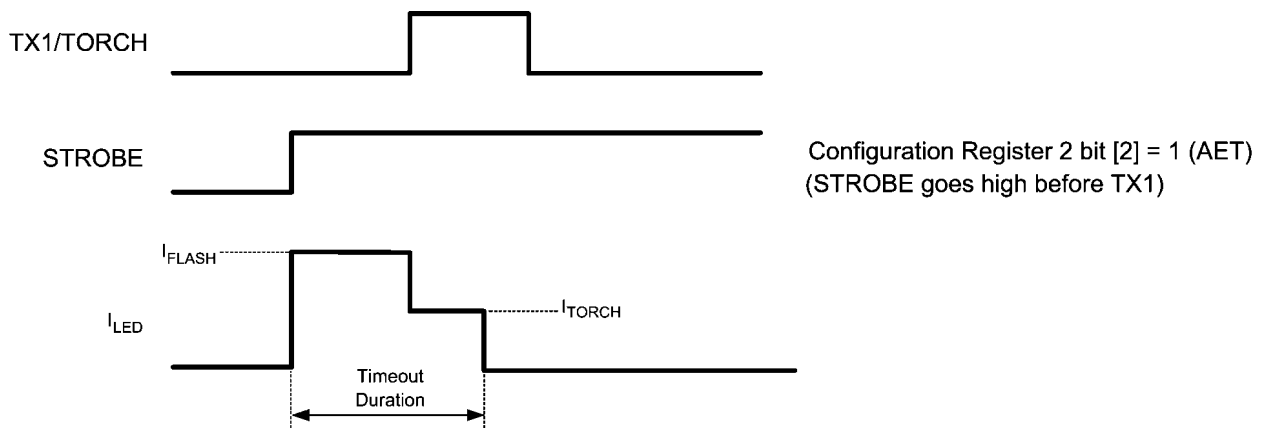

30042045

FIGURE 11. Alternative External Torch Mode (STROBE Goes High Before TX1/TORCH, Same as Default with SEM = 0)

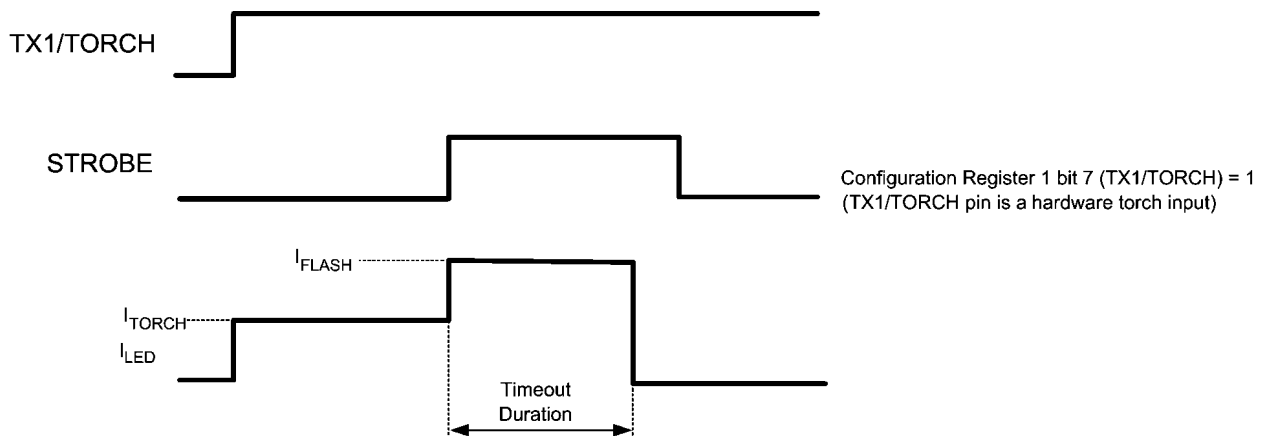

30042046

FIGURE 12. TX1/TORCH Configured as a Hardware Torch input

FLAGS REGISTER AND FAULT INDICATORS

The Flags Register (0xD0) contains the Interrupt and Fault indicators. Five fault flags are available in the LM3554. These include a Thermal Shutdown, an LED Failure Flag (LEDF), a Timeout indicator Flag (TO), a LED Thermal Flag (NTC), and a VIN Monitor Flag. Additionally, two interrupt flag bits TX1 interrupt and TX2 interrupt indicate a change of state of the TX1/TORCH pin (TX1 mode) and ENVM/TX2 pin (TX2 mode). Reading back a "1" indicates the TX lines have changed state since the last read of the Flags Register. A read of the Flags Register resets these bits.

Thermal Shutdown

When the LM3554's die temperature reaches +150°C the boost converter shuts down, and the NFET and PFET turn off. Additionally, all three current sources (LED1, LED2, and LED3) turn off. When the thermal shutdown threshold is tripped a (1) gets written to bit [1] of the Flag Register (Thermal Shutdown bit). The LM3554 will start up again when the die temperature falls to below +135°C.

During heavy load conditions when the internal power dissipation in the device causes thermal shutdown, the part will turn off and start up again after the die temperature cools. This will result in a pulsed on/off operation. The OVT bit however will only get written once. To reset the OVT bit pull HWEN low, power down the LM3554, or read the Flags Register.

LED Fault

The LED Fault flag (bit 2 of the Flags Register) reads back a (1) if the part is active in Flash or Torch mode and either LED1 or LED2 experience an open or short condition. An LED open condition is signaled if the OVP threshold is crossed at OUT while the device is in Flash or Torch mode. An LED short condition is signaled if the voltage at LED1 or LED2 goes below 500mV while the device is in Torch or Flash mode.

There is a delay of 250µs before the LEDF flag is valid on a LED short. This is the time from when VLED falls below the LED short threshold of 500mV (typical) to when the fault flag is valid. There is a delay of 2µs from when the LEDF flag is valid on an LED open. This delay is the time between when the OVP threshold is triggered and when the fault flag is valid. The LEDF flag can only be reset to (0) by pulling HWEN low, removing power to the LM3554, or reading the Flags Register.

Flash Timeout

The TO flag (bit [0] of the Flags Register) reads back a (1) if the LM3554 is active in Flash mode and the Timeout period expires before the Flash pulse is terminated. The flash pulse can be terminated before the Timeout period expires by pulling the STROBE pin low (with STR bit '0'), or by writing a '0' to bit 0 or 1 of the Torch Brightness Register or the Flash Brightness Register. The TO flag is reset to (0) by pulling HWEN low, removing power to the LM3554, reading the Flags Register, or when the next Flash pulse is triggered.

LED Thermal Fault

The NTC flag (bit [5] of the Flags Register) reads back a (1) if the LM3554 is active in Flash or Torch mode, the device is in NTC mode, and the voltage at LED1/NTC has fallen below V_{TRIP} (1.05V typical). When this has happened and the LM3554 has been forced into Torch or LED shutdown (depending on the state of Configuration Register 2 bit [1], the Flags Register must be read in order to place the device back in normal operation. (See [Thermal Comparator Mode \(NTC\)](#) section for more details.)

Input Voltage Monitor Fault

The V_{IN} Monitor Flag (bit [6] of the Flag Register) reads back a '1' when the Input Voltage Monitor is enabled and V_{IN} falls below the programmed VIN Monitor threshold. This flag must be read back in order to resume normal operation after the LED current has been forced to Torch mode or turned off due to a VIN Monitor event.

TX1 and TX2 Interrupt Flags

The TX1 and TX2 interrupt flags (bits [3] and [4]) indicate a TX event on the TX1/TORCH and ENVM/TX2 pins. Bit 3 will read back a (1) if TX1/TORCH is in TX1 mode and the pin has changed from low to high since the last read of the Flags Register. Bit 4 will read back a (1) if ENVM/TX2 is in TX2 mode and the pin has had a TX event since the last read of the Flags Register. A read of the Flags Register automatically resets these bits.

The ENVM/TX2/GPIO2 pin, when configured in TX2 mode, has a TX event that can be either a high-to-low transition or a low-to-high transition depending on the setting of the TX2 polarity bit (see Configuration Register 1 Bit [6]).

I²C-Compatible Interface

START AND STOP CONDITIONS

The LM3554 is controlled via an I²C-compatible interface. START and STOP conditions classify the beginning and end of the I²C session. A START condition is defined as SDA

transitioning from HIGH to LOW while SCL is HIGH. A STOP condition is defined as SDA transitioning from LOW to HIGH while SCL is HIGH. The I²C master always generates the START and STOP conditions.

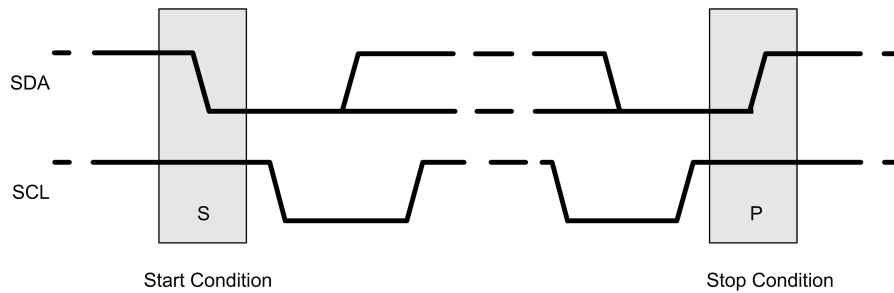

30042018

FIGURE 13. Start and Stop Sequences

The I²C bus is considered busy after a START condition and free after a STOP condition. During data transmission the I²C master can generate repeated START conditions. A START and a repeated START condition are equivalent function-wise. The data on SDA must be stable during the HIGH

period of the clock signal (SCL). In other words, the state of SDA can only be changed when SCL is LOW. Figure 1 and Figure 14 show the SDA and SCL signal timing for the I²C-Compatible Bus. See the Electrical Characteristics Table for timing values.

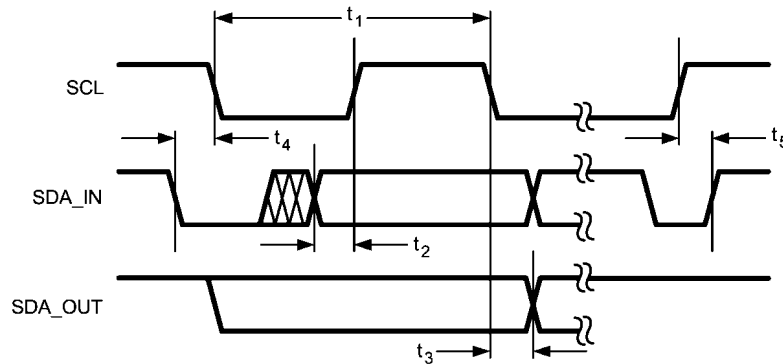

30042019

FIGURE 14. I²C-Compatible Timing

I²C-COMPATIBLE CHIP ADDRESS

The device address for the LM3554 is 1010011 (53). After the START condition, the I²C master sends the 7-bit address followed by an eighth bit, read or write (R/W). R/W = 0 indicates

a WRITE and R/W = 1 indicates a READ. The second byte following the device address selects the register address to which the data will be written. The third byte contains the data for the selected register.

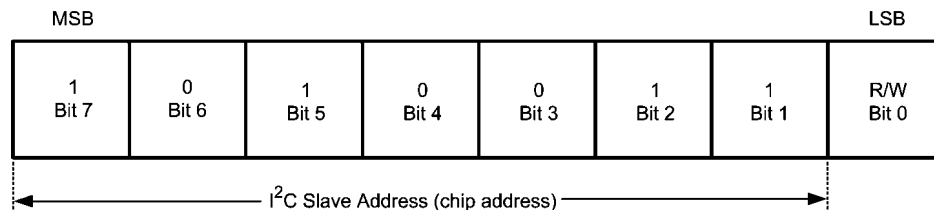

30042020

FIGURE 15. Device Address

TRANSFERRING DATA

Every byte on the SDA line must be eight bits long, with the most significant bit (MSB) transferred first. Each byte of data must be followed by an acknowledge bit (ACK). The acknowledge related clock pulse (9th clock pulse) is generated by the

master. The master releases SDA (HIGH) during the 9th clock pulse (write mode). The LM3554 pulls down SDA during the 9th clock pulse, signifying an acknowledge. An acknowledge is generated after each byte has been received.

Register Descriptions

TABLE 1. LM3554 Internal Registers

Register Name	Internal Hex Address	Power On or Reset Value
Torch Brightness	0xA0	0x50
Flash Brightness	0xB0	0x68
Flash Duration	0xC0	0x4F
Flag Register	0xD0	0x40
Configuration Register 1	0xE0	0x42
Configuration Register 2	0xF0	0xF0
GPIO Register	0x20	0x80
VIN Monitor Register	0x80	0xF0

TORCH BRIGHTNESS REGISTER

Bits [2:0] of the Torch Brightness Register, or bits [2:0] of the Flash Brightness Register place the device in shutdown or control the on/off state of Torch, Flash, the Indicator LED and the Voltage output mode (see [Table 2](#)). Writing to Torch Brightness Register bits [2:0] automatically updates the Flash

Brightness Register bits [2:0]; writing to bits [2:0] of the Flash Brightness Register automatically updates bits [2:0] of the Torch Brightness Register. Bits [5:3] set the current level in Torch mode (see [Table 2](#)). Bits [7:6] set the LED Indicator current level (see [Table 2](#)).

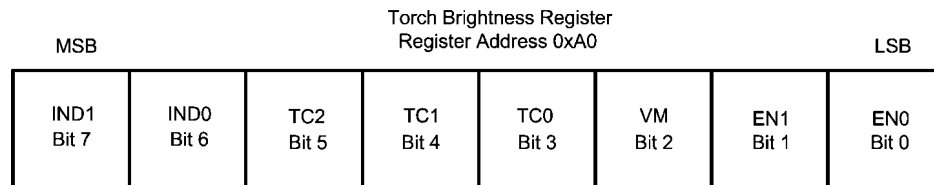

30042021

FIGURE 16. Torch Brightness Register Description

TABLE 2. Torch Brightness Register Bit Settings

Bit 7 (IND1)	Bit 6 (IND0)	Bit 5 (TC2)	Bit 4 (TC1)	Bit 3 (TC0)	Bit 2 (VM)	Bit 1 (EN1)	Bit 0 (EN0)
Indicator Current Select Bits 00 = 2.3mA 01 = 4.6mA (default state) 10 = 6.9mA 11 = 8.2mA	Torch Current Select Bits 000 = 17mA (34mA total) 001 = 35.5mA (71mA total) 010 = 54mA (108mA total) default state 011 = 73mA (146mA total) 100 = 90mA (180mA total) 101 = 109mA (218mA total) 110 = 128mA (256mA total) 111 = 147.5mA (295mA total)			Enable Bits 000 = Shutdown (default) 001 = Indicator Mode 010 = Torch Mode 011 = Flash Mode (bits reset at timeout) 100 = Voltage Output Mode 101 = Voltage Output + Indicator Mode 110 = Voltage Output + Torch Mode 111 = Voltage Output + Flash Mode (bits [1:0] are reset at end of timeout)			

FLASH BRIGHTNESS REGISTER

Bits [2:0] of the Torch Brightness Register, or bits [2:0] of the Flash Brightness Register place the device in shutdown or control the on/off state of Torch, Flash, the Indicator LED and the Voltage output mode. Writing to the Flash Brightness

Register bits [2:0] automatically updates the Torch Brightness Register bits [2:0]. Bits [6:3] set the current level in Flash mode (see [Table 3](#)). Bit [7] sets the STROBE Termination select bit (STR) (see [Table 3](#)).

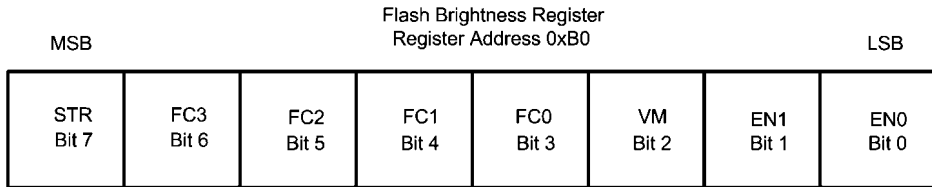

30042022

FIGURE 17. Flash Brightness Register Description**TABLE 3. Flash Brightness Register Bit Settings**

Bit 7 (STR)	Bit 6 (FC3)	Bit 5 (FC2)	Bit 4 (FC1)	Bit 3 (FC0)	Bit 2 (VM)	Bit 1 (EN1)	Bit 0 (EN0)
STROBE Edge or Level Select 0 = (Level Sensitive) When STROBE goes high, Flash current will turn on and remain on for the duration the STROBE pin is held high or when Flash Timeout occurs, whichever comes first. (default) 1 = (Edge Triggered) When STROBE goes high, Flash current will turn on and remain on for the duration of the Flash Timeout.	Flash Current Select Bits 0000 = 35.5mA (71mA total) 0001 = 73mA (146mA total) 0010 = 109mA (218mA total) 0011 = 147.5mA (295mA total) 0100 = 182.5mA (365mA total) 0101 = 220.5mA (441mA total) 0110 = 259mA (518mA total) 111 = 298mA (596mA total) 1000 = 326mA (652mA total) 1001 = 364.5mA (729mA total) 1010 = 402.5mA (805mA total) 1011 = 440.5mA (881mA total) 1100 = 480mA (960mA total) 1101 = 518.5mA (1037mA total) Default 1110 = 556.5mA (1113mA total) 1111 = 595.5mA (1191mA total)				Enable Bits 000 = Shutdown (default) 001 = Indicator Mode 010 = Torch Mode 011 = Flash Mode (bits reset at timeout) 100 = Voltage Output Mode 101 = Voltage Output + Indicator Mode 110 = Voltage Output + Torch Mode 111 = Voltage Output + Flash Mode (bits [1:0] are reset at end of timeout)		

FLASH DURATION REGISTER

Bits [4:0] of the Flash Duration Register set the Flash Timeout duration. Bits [6:5] set the switch current limit. Bit [7] defaults as a '1' and is not used (see [Table 4](#)).

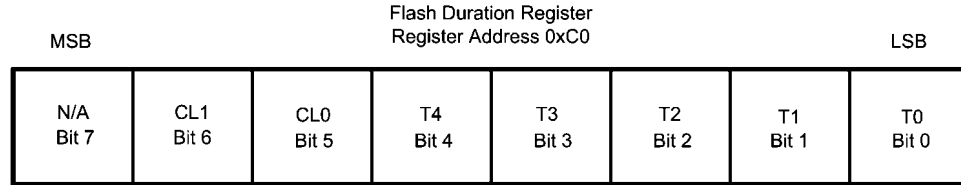

30042023

FIGURE 18. Flash Duration Register Description**TABLE 4. Flash Duration Register Bit Settings**

Bit 7 (Not used)	Bit 6 (CL1)	Bit 5 (CL0)	Bit 4 (T4)	Bit 3 (T3)	Bit 2 (T2)	Bit 1 (T1)	Bit 0 (T0)
Reads Back '0'	Current Limit Select Bits 00 = 1A Peak Current Limit 01 = 1.5A Peak Current Limit t10 = 2A Peak Current Limit (default) 11 = 2.5A Peak Current Limit		Flash Timeout Select Bits 00000 = 32ms timeout 00001 = 64ms timeout 00010 = 96ms timeout 00011 = 128ms timeout 00100 = 160ms timeout 00101 = 192ms timeout 00110 = 224ms timeout 00111 = 256ms timeout 01000 = 288ms timeout 01001 = 320ms timeout 01010 = 352ms timeout 01011 = 384ms timeout 01100 = 416ms timeout 01101 = 448ms timeout 01110 = 480ms timeout 01111 = 512ms timeout (default) 10000 = 544ms timeout 10001 = 576ms timeout 10010 = 608ms timeout 10011 = 640ms timeout 10100 = 672ms timeout 10101 = 704ms timeout 10110 = 736ms timeout 10111 = 768ms time-out 11000 = 800ms timeout 11001 = 832ms timeout 11010 = 864ms timeout 11011 = 896ms timeout 11100 = 928ms timeout 11101 = 960ms timeout 11110 = 992ms timeout 11111 = 1024ms timeout				

FLAGS REGISTER

The Flags Register holds the status of the flag bits indicating LED Failure, Over-Temperature, the Flash Timeout expiring,

VIN Monitor Fault, LED over temperature (NTC), and a TX interrupt. (See [Figure 18](#) and [Table 4](#).)

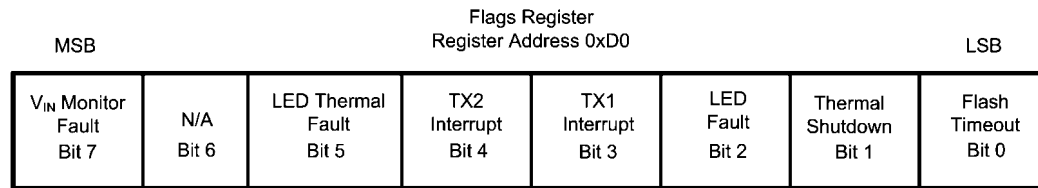

30042024

FIGURE 19. Flags Register Description

TABLE 5. Flags Register Bit Settings

Bit 7 (VIN Monitor Fault)	Bit 6 (Unused)	Bit 5 (LED Thermal Fault)	Bit 4 (TX2 Interrupt)	Bit 3 (TX1 Interrupt)	Bit 2 (LED Fault)	Bit 1 (Thermal Shutdown)	Bit 0 (Flash Timeout)
0=No Fault at VIN (default)	Not Used (Reads Back '1')	0=LEDI/NTC pin is above V_{TRIP} (default)	0=ENVM/TX2 has not changed state (default)	0=TX1/TORCH has not changed state (default)	0 = Proper LED Operation (default)	0 = Die Temperature below Thermal Shutdown Limit (default)	0 = Flash TimeOut did not expire (default)
1=Input Voltage Monitor is enabled and VIN has fallen below the programmed threshold		1=LEDI/NTC has fallen below V_{TRIP} (NTC mode only)	1=ENVM/TX2 has changed state (TX2 mode only)	1=TX1/TORCH pin has changed state (TX1 mode only)	1 = LED Failed (Open or Short)	1 = Die Temperature has crossed the Thermal Shutdown Threshold	1 = Flash TimeOut Expired

CONFIGURATION REGISTER 1

Configuration Register 1 holds the light load disable bit, the voltage mode select bit (OV), the external flash inhibit bit, the control bit for the LEDI/NTC pin, the control bit for ENVM to

TX2 mode, the polarity selection bit for the TX2 input, and the control bit for the TX1/TORCH bit (see [Figure 20](#) and [Table 6](#)).

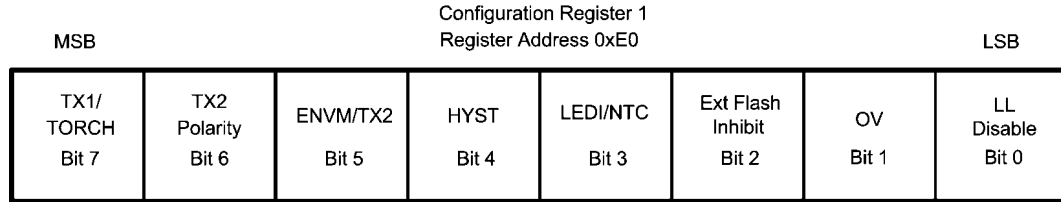

30042025

FIGURE 20. Configuration Register1 Description**TABLE 6. Configuration Register 1 Bit Settings**

Bit 7 (Hardware Torch Mode Enable)	Bit 6 (TX2 Polarity)	Bit 5 (ENVM/ TX2)	Bit 4 (N/A)	Bit 3 (LEDI/ NTC)	Bit 2 (External Flash Inhibit)	Bit 1 (OV, Output Voltage Select)	Bit 0 (Disable Light Load)
0 = TX1/ TORCH is a TX1 flash interrupt input (default)	0 = ENVM/TX2 pin is an active low Flash inhibit	0 = ENVM Mode The ENVM/TX2 pin is a logic input to enable Voltage Mode. A high on ENVM/TX2 will force Voltage Output Mode (default)	Reads Back '0'	0 = LEDI/NTC pin in Indicator mode (default)	0 = STROBE Input Enabled (default)	0 = Voltage Mode output voltage is 4.5V	0 = Light load comparator is enabled. The LM3554 will go into PFM mode at light load (default) .
1 = TX1/ TORCH pin is a hardware TORCH enable	1 = ENVM/TX2 pin is an active high Flash inhibit (default)	1 = TX2 Mode The ENVM/ TX2 is a Power Amplifier Synchronizati on input. A high on ENVM/TX2 will force the LM3554 from Flash to Torch mode.		1 = LEDI/NTC pin in Thermal Comparator Mode. Indicator current is disabled.	1 = STROBE Input Disabled	1 = Voltage Mode output voltage is 5V (default)	1 = Light load comparator is disabled. The LM3554 will not go into PFM mode at light load.

CONFIGURATION REGISTER 2

Configuration Register 2 contains the bits to select if TX2, NTC, and the VIN monitor force Torch mode or force the Flash

LEDs into shutdown. Additionally, bit [2] (AET bit) selects the Alternate External Torch mode (see [Figure 21](#) and [Table 7](#)).

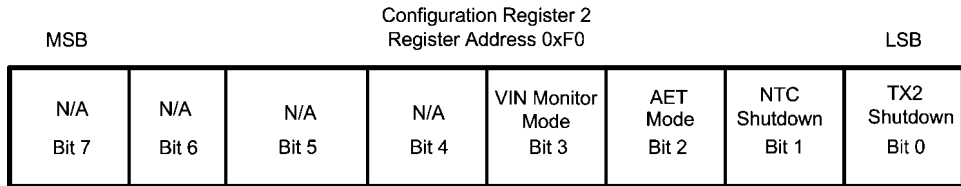

30042036

FIGURE 21. Configuration Register 2 Description

TABLE 7. Configuration Register 2 Bit Settings

Bit 7 (Not used)	Bit 6 (Not used)	Bit 5 (Not used)	Bit 4 (Not used)	Bit 3 (V _{IN} Monitor Shutdown)	Bit 2 (AET mode)	Bit 1 (NTC Shutdown)	Bit 0 (TX2 Shutdown)
Reads Back '1'	Reads Back '1'	Reads Back '1'	Reads Back '1'	0 = If IN drops below the programmed threshold and the VIN Monitor feature is enabled, the LED's are forced into Torch mode (default)	0 = Normal operation for TX1/TORCH high before STROBE (TX1 mode only) default	0 = LEDI/NTC pin going below V _{TRIP} forces the LEDs into Torch mode (NTC mode only) default	0 = TX2 event forces the LEDs into Torch mode (TX2 mode only) default
				1 = If IN drops below the programmed threshold and the VIN Monitor feature is enabled, the LED's turn off	1 = Alternative External Torch operation. TX1/TORCH high before STROBE forces Torch mode with no timeout (TX1 mode only)	1 = LEDI/NTC pin going below V _{TRIP} forces the LEDs into shutdown (NTC mode only)	1 = TX2 event forces the LEDs into shutdown (TX2 mode only)

GPIO REGISTER

The GPIO register contains the control bits which change the state of the TX1/TORCH/GPIO1 pin and the ENVM/TX2/GPIO2 pin to general purpose I/O's (GPIO's). Additionally, bit [6] of this register configures the ENVM/TX2/GPIO2 as a

hardware interrupt output reflecting the NTC flag bit in the Flags Register. [Figure 22](#) and [Table 8](#) describe the bit description and functionality of the GPIO register.

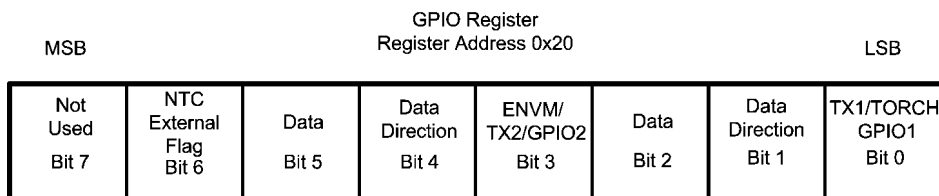

30042026

FIGURE 22. GPIO Register Description

TABLE 8. GPIO Register Bit Settings

Bit 7 (Not Used)	Bit 6 (NTC External Flag)	Bit 5 (ENVM/TX2/GPIO2 data)	Bit 4 (ENVM/TX2/GPIO2 data direction)	Bit 3 (ENVM/TX2/GPIO2 Control)	Bit 2 (TX1/TORCH/GPIO1 data)	Bit 1 (TX1/TORCH/GPIO1 data direction)	Bit 0 (TX1/TORCH/GPIO1 Control)
Reads Back '1'	0 = NTC External Flag mode is disabled (default)	This bit is the read or write data for the ENVM/TX2/GPIO2 pin in GPIO mode (default is 0)	0 = ENVM/TX2/GPIO2 is a GPIO Input (default)	0 = ENVM/TX2/GPIO2 is configured according to the Configuration Register bit 5 (default)	This bit is the read or write data for the TX1/TORCH/GPIO1 pin in GPIO mode (default is 0)	0 = TX1/TORCH/GPIO1 is a GPIO input (default)	0 = TX1/TORCH/GPIO1 pin is configured as an active low reset input (default)
	1 = When ENVM/TX2/GPIO2 is configured as a GPIO output the ENVM/TX2/GPIO2 pin will pull low when the LED Thermal Fault Flag is set		1 = ENVM/TX2/GPIO2 is a GPIO Output	1 = ENVM/TX2/GPIO2 is configured as a GPIO		1 = TX1/TORCH/GPIO1 is an output	1 = TX1/TORCH/GPIO1 pin is configured as a GPIO

V_{IN} MONITOR REGISTER

The V_{IN} Monitor Register controls the on/off state of the V_{IN} Monitor comparator as well as selects the 4 programmable

thresholds. [Figure 23](#) and [Table 9](#) describe the bit settings of the V_{IN} Monitor feature.

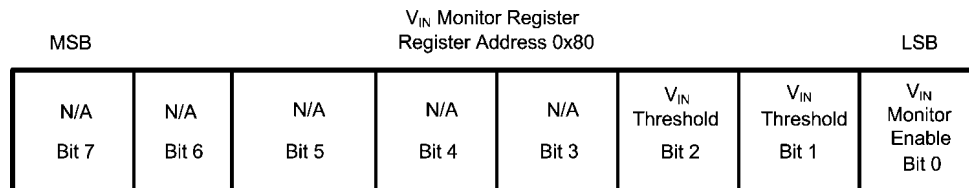

30042047

FIGURE 23. V_{IN} Monitor Register DescriptionTABLE 9. V_{IN} Monitor Register Bit Settings

Bit 7 (Not used)	Bit 6 (Not used)	Bit 5 (Not used)	Bit 4 (Not used)	Bit 3 (Not used)	Bit 2 (VIN Threshold)	Bit 1 (VIN Threshold)	Bit 0 (VIN Monitor Enable)
Reads Back '1'	Reads Back '1'	Reads Back '1'	Reads Back '1'	Reads Back '0'	00 = 3.1V threshold (V _{IN} falling) Default 01=3.2V threshold (V _{IN} falling) 10 = 3.3V threshold (V _{IN} falling) 11 = 3.4V threshold (V _{IN} falling)		0 = V _{IN} Monitoring Comparator is disabled (default)
							1 = V _{IN} Monitoring Comparator is enabled.

Applications Information

OUTPUT CAPACITOR SELECTION

The LM3554 is designed to operate with a at least a 4.7µF ceramic output capacitor in LED mode and a 10µF output capacitor in Voltage Output Mode. When the boost converter is running the output capacitor supplies the load current during the boost converters on-time. When the NMOS switch turns off the inductor energy is discharged through the internal PMOS switch supplying power to the load and restoring charge to the output capacitor. This causes a sag in the output voltage during the on-time and a rise in the output voltage during the off-time. The output capacitor is therefore chosen to limit the output ripple to an acceptable level depending on load current and input/output voltage differentials and also to ensure the converter remains stable.

For proper LED operation the output capacitor must be at least a 4.7µF ceramic (10µF in Voltage Output Mode). Larger capacitors such as 10µF or 22µF can be used if lower output voltage ripple is desired. To estimate the output voltage ripple considering the ripple due to capacitor discharge (ΔV_Q) and the ripple due to the capacitors ESR (ΔV_{ESR}) use the following equations:

For continuous conduction mode, the output voltage ripple due to the capacitor discharge is:

$$\Delta V_Q = \frac{I_{LED} \times (V_{OUT} - V_{IN})}{f_{SW} \times V_{OUT} \times C_{OUT}}$$

The output voltage ripple due to the output capacitors ESR is found by:

$$\Delta V_{ESR} = R_{ESR} \times \left(\frac{I_{LED} \times V_{OUT}}{V_{IN}} \right) + \Delta I_L$$

$$\text{where } \Delta I_L = \frac{V_{IN} \times (V_{OUT} - V_{IN})}{2 \times f_{SW} \times L \times V_{OUT}}$$

In ceramic capacitors the ESR is very low so assume that 80% of the output voltage ripple is due to capacitor discharge and 20% from ESR. [Table 10](#) lists different manufacturers for various output capacitors and their case sizes suitable for use with the LM3554.

INPUT CAPACITOR SELECTION

Choosing the correct size and type of input capacitor helps minimize the voltage ripple caused by the switching of the LM3554's boost converter and reduces noise on the devices input terminal that can feed through and disrupt internal analog signals. In the Typical Application Circuit a 4.7µF ceramic input capacitor works well. It is important to place the input capacitor as close as possible to the LM3554's input (IN) terminals. This reduces the series resistance and inductance that can inject noise into the device due to the input switching currents. [Table 10](#) lists various input capacitors that or recommended for use with the LM3554.

TABLE 10. Recommended Input/Output Capacitors (X5R Dielectric)

Manufacturer	Part Number	Value	Case Size	Voltage Rating
TDK Corporation	C1608JB0J475K	4.7µF	0603(1.6mm×0.8mm×0.8mm)	6.3V
TDK Corporation	C1608JB0J106M	10µF	0603(1.6mm×0.8mm×0.8mm)	6.3V
TDK Corporation	C2012JB1C475K	4.7µF	0805(2mm×1.25mm×1.25mm)	16V
TDK Corporation	C2012JB1A106M	10µF	0805(2mm×1.25mm×1.25mm)	10V
TDK Corporation	C2012JB0J226M	22µF	0805(2mm×1.25mm×1.25mm)	6.3V
Murata	GRM188R60J475KE19	4.7µF	0603(1.6mm×0.8mm×0.8mm)	6.3V
Murata	GRM21BR61C475KA88	4.7µF	0805(2mm×1.25mm×1.25mm)	16V
Murata	GRM21BR61A106KE19	10µF	0805(2mm×1.25mm×1.25mm)	10V
Murata	GRM21BR60J226ME39L	22µF	0805(2mm×1.25mm×1.25mm)	6.3V

INDUCTOR SELECTION

The LM3554 is designed to use a 2.2µH inductor. [Table 11](#) lists various inductors and their manufacturers that can work well with the LM3554. When the device is boosting ($V_{OUT} > V_{IN}$) the inductor will typically be the biggest area of efficiency loss in the circuit. Therefore, choosing an inductor with the lowest possible series resistance is important. Additionally, the saturation rating of the inductor should be greater than the maximum operating peak current of the LM3554. This prevents excess efficiency loss that can occur with inductors that operate in saturation and prevents over heating of the inductor and possible damage. For proper inductor operation and

circuit performance ensure that the inductor saturation and the peak current limit setting of the LM3554 is greater than I_{PEAK} can be calculated by:

$$I_{PEAK} = \frac{I_{LOAD}}{\eta} \times \frac{V_{OUT}}{V_{IN}} + \Delta I_L \quad \text{where } \Delta I_L = \frac{V_{IN} \times (V_{OUT} - V_{IN})}{2 \times f_{SW} \times L \times V_{OUT}}$$

$f_{SW} = 2\text{MHz}$; η can be found in the Typical Performance Characteristics plots.

TABLE 11. Recommended Inductors

Manufacturer	L	Part Number	Dimensions (L×W×H)	I_{SAT}
TOKO	2.2µH	FDSE0312-2R2M	3mm×3mm×1.2mm	2A
TDK	2.2µH	VLS252012T-2R2M1R3	2mm×2.5mm×1.2mm	1.5A
Coilcraft	2.2µH	LPS4018-222ML	3.9mm×3.9mm×1.7mm	2.3A

NTC THERMISTOR SELECTION

NTC thermistors have a temperature to resistance relationship of:

$$R(T) = R_{25^{\circ}\text{C}} \times e^{\left[\beta \left(\frac{1}{T^{\circ}\text{C} + 273} - \frac{1}{298} \right) \right]}$$

where β is given in the thermistor datasheet and $R_{25^{\circ}\text{C}}$ is the thermistors value at $+25^{\circ}\text{C}$. R_3 in [Figure 25](#) is chosen so that it is equal to:

$$R_3 = \frac{R_{T(\text{TRIP})} (V_{\text{BIAS}} - V_{\text{TRIP}})}{V_{\text{TRIP}}}$$

where $R_{T(\text{TRIP})}$ is the thermistors value at the temperature trip point, V_{BIAS} is shown in [Figure 25](#), and $V_{\text{TRIP}} = 1.05\text{V}$ (typical).

Choosing R_3 here gives a more linear response around the temperature trip voltage. For example, with $V_{\text{BIAS}} = 2.5\text{V}$, a thermistor whose nominal value at $+25^{\circ}\text{C}$ is $100\text{k}\Omega$ and a $\beta = 4500\text{K}$, the trip point is chosen to be $+93^{\circ}\text{C}$. The value of $R(T)$ at 93°C is:

$$R(T) = 100 \text{ k}\Omega \times e^{\left[\beta \left(\frac{1}{93 + 273} - \frac{1}{298} \right) \right]} = 6.047 \text{ k}\Omega$$

$$R_3 \text{ is then: } \frac{6.047 \text{ k}\Omega \times (2.5\text{V} - 1\text{V})}{1\text{V}} = 9.071 \text{ k}\Omega$$

[Figure 24](#) shows the linearity of the thermistor resistive divider of the previous example.

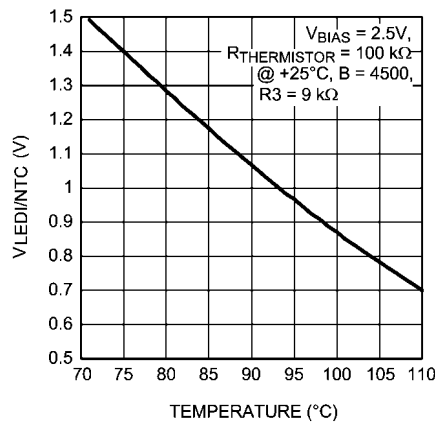

30042034

FIGURE 24. Thermistor Resistive Divider Response vs Temperature

Another useful equation for the thermistor resistive divider is developed by combining the equations for R_3 , and $R(T)$ and solving for temperature. This gives the following relationship.

$$T(^{\circ}\text{C}) = \frac{\beta \times 298^{\circ}\text{C}}{298^{\circ}\text{C} \times \text{LN} \left[\frac{V_{\text{TRIP}} \times R_3}{(V_{\text{BIAS}} - V_{\text{TRIP}}) \times R_{25^{\circ}\text{C}}} \right] + \beta} - 273^{\circ}\text{C}$$

Using a spreadsheet such as Excel, different curves for the temperature trip point $T(^{\circ}\text{C})$ can be created vs R_3 , Beta, or

V_{BIAS} in order to help better choose the thermal components for practical values of thermistors, series resistors (R_3), or reference voltages V_{BIAS} .

Programming bit [3] of the Configuration register with a (1) selects Thermal Comparator mode making the LEDI/NTC pin a comparator input for flash LED thermal sensing. [Figure 25](#) shows the internal block diagram of the thermal sensing circuit which is OR'd with both the TX1 and ENVM/TX2 (TX2 mode) to force the LM3554 from Flash to Torch mode. This is intended to prevent LED overheating during flash pulses.

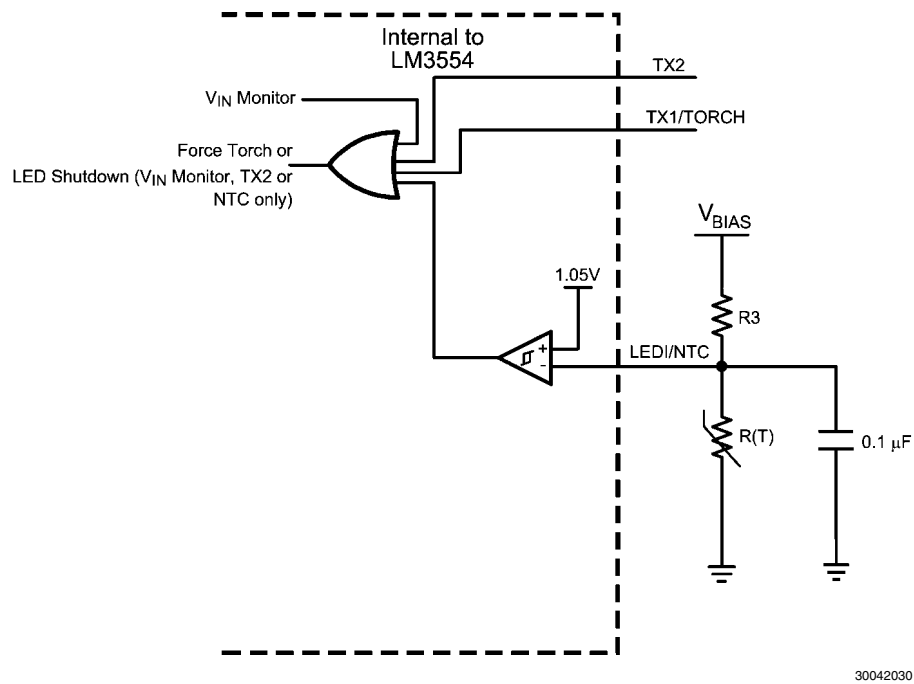

FIGURE 25. Thermistor Voltage Divider and Sensing Circuit

NTC THERMISTOR PLACEMENT

The termination of the thermistor must be done directly to the cathode of the Flash LED in order to adequately couple the heat from the LED into the thermistor. Consequentially, the noisy environment generated from the switching of the LM3554's boost converter can introduce noise from GND into

the thermistor sensing input. To filter out this noise it is necessary to place a 0.1 μ F or larger ceramic capacitor close to the LEDI/NTC pin. The filter capacitor's return must also connect with a low-impedance trace, as close as possible to the PGND pin of the LM3554.

Layout Recommendations

The high frequency and large switching currents of the LM3554 make the choice of layout important. The following steps should be used as a reference to ensure the device is stable and maintains proper voltage and current regulation across its intended operating voltage and current range.

1. Place C_{IN} on the top layer (same layer as the LM3554) and as close to the device as possible. The input capacitor conducts the driver currents during the low-side MOSFET turn-on and turn-off and can see current spikes over 1A in amplitude. Connecting the input capacitor through short wide traces on both the IN and GND terminals will reduce the inductive voltage spikes that occur during switching and which can corrupt the V_{IN} line.
2. Place C_{OUT} on the top layer (same layer as the LM3554) and as close as possible to the OUT and GND terminal. The returns for both C_{IN} and C_{OUT} should come together at one point, and as close to the GND pin as possible. Connecting C_{OUT} through short wide traces will reduce the series inductance on the OUT and GND terminals that can corrupt the V_{OUT} and GND line and cause excessive noise in the device and surrounding circuitry.
3. Connect the inductor on the top layer close to the SW pin. There should be a low impedance connection from the inductor to SW due to the large DC inductor current, and at the same time the area occupied by the SW node should be small so as to reduce the capacitive coupling of the high dV/dt present at SW that can couple into nearby traces.
4. Avoid routing logic traces near the SW node so as to avoid any capacitively coupled voltages from SW onto any high-impedance logic lines such as TX1/TORCH/GPIO1, ENVM/TX2/GPIO2, HWEN, LED1/NTC (NTC mode), SDA, and SCL. A good approach is to insert an inner layer GND plane underneath the SW node and between any nearby routed traces. This creates a shield from the electric field generated at SW.
5. Terminate the Flash LED cathodes directly to the GND pin of the LM3554. If possible, route the LED returns with a dedicated path so as to keep the high amplitude LED currents out the GND plane. For Flash LEDs that are routed relatively far away from the LM3554, a good approach is to sandwich the forward and return current paths over the top of each other on two layers. This will help in reducing the inductance of the LED current paths.
6. The NTC Thermistor is intended to have its return path connected to the LED's cathode. This allows the thermistor resistive divider voltage (V_{NTC}) to trip the comparators threshold as V_{NTC} is falling. Additionally, the thermistor-to-LED cathode junction can have low thermal resistivity since both the LED and the thermistor are electrically connected at GND. The drawback is that the thermistor's return will see the switching currents from the LM3554's boost converter. Because of this, it is necessary to have a filter capacitor at the NTC pin which terminates close to the GND of the LM3554 and which can conduct the switched currents to GND.

Physical Dimensions inches (millimeters) unless otherwise noted

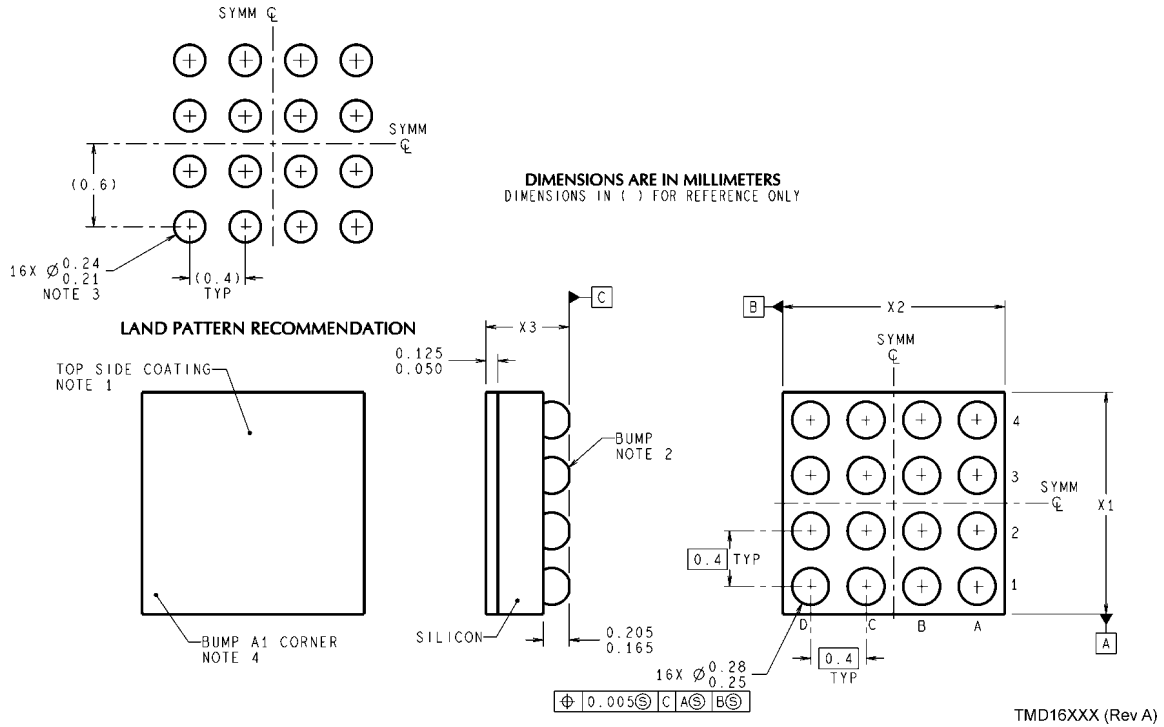

16 Bump μSMD (0.4mm pitch)
For Ordering, Refer to Ordering Information Table
NS Package Number TMD16CCA
X1 = 1.695mm (±0.03mm), X2 = 1.695mm (±0.03mm), X3 = 0.6mm(±0.075mm)

Notes

For more National Semiconductor product information and proven design tools, visit the following Web sites at:
www.national.com

Products		Design Support	
Amplifiers	www.national.com/amplifiers	WEBENCH® Tools	www.national.com/webench
Audio	www.national.com/audio	App Notes	www.national.com/appnotes
Clock and Timing	www.national.com/timing	Reference Designs	www.national.com/refdesigns
Data Converters	www.national.com/adc	Samples	www.national.com/samples
Interface	www.national.com/interface	Eval Boards	www.national.com/evalboards
LVDS	www.national.com/lvds	Packaging	www.national.com/packaging
Power Management	www.national.com/power	Green Compliance	www.national.com/quality/green
Switching Regulators	www.national.com/switchers	Distributors	www.national.com/contacts
LDOs	www.national.com/lido	Quality and Reliability	www.national.com/quality
LED Lighting	www.national.com/led	Feedback/Support	www.national.com/feedback
Voltage References	www.national.com/vref	Design Made Easy	www.national.com/easy
PowerWise® Solutions	www.national.com/powerwise	Applications & Markets	www.national.com/solutions
Serial Digital Interface (SDI)	www.national.com/sdi	Mil/Aero	www.national.com/milaero
Temperature Sensors	www.national.com/tempensors	SolarMagic™	www.national.com/solarmagic
PLL/VCO	www.national.com/wireless	PowerWise® Design University	www.national.com/training

THE CONTENTS OF THIS DOCUMENT ARE PROVIDED IN CONNECTION WITH NATIONAL SEMICONDUCTOR CORPORATION ("NATIONAL") PRODUCTS. NATIONAL MAKES NO REPRESENTATIONS OR WARRANTIES WITH RESPECT TO THE ACCURACY OR COMPLETENESS OF THE CONTENTS OF THIS PUBLICATION AND RESERVES THE RIGHT TO MAKE CHANGES TO SPECIFICATIONS AND PRODUCT DESCRIPTIONS AT ANY TIME WITHOUT NOTICE. NO LICENSE, WHETHER EXPRESS, IMPLIED, ARISING BY ESTOPPEL OR OTHERWISE, TO ANY INTELLECTUAL PROPERTY RIGHTS IS GRANTED BY THIS DOCUMENT.

TESTING AND OTHER QUALITY CONTROLS ARE USED TO THE EXTENT NATIONAL DEEMS NECESSARY TO SUPPORT NATIONAL'S PRODUCT WARRANTY. EXCEPT WHERE MANDATED BY GOVERNMENT REQUIREMENTS, TESTING OF ALL PARAMETERS OF EACH PRODUCT IS NOT NECESSARILY PERFORMED. NATIONAL ASSUMES NO LIABILITY FOR APPLICATIONS ASSISTANCE OR BUYER PRODUCT DESIGN. BUYERS ARE RESPONSIBLE FOR THEIR PRODUCTS AND APPLICATIONS USING NATIONAL COMPONENTS. PRIOR TO USING OR DISTRIBUTING ANY PRODUCTS THAT INCLUDE NATIONAL COMPONENTS, BUYERS SHOULD PROVIDE ADEQUATE DESIGN, TESTING AND OPERATING SAFEGUARDS.

EXCEPT AS PROVIDED IN NATIONAL'S TERMS AND CONDITIONS OF SALE FOR SUCH PRODUCTS, NATIONAL ASSUMES NO LIABILITY WHATSOEVER, AND NATIONAL DISCLAIMS ANY EXPRESS OR IMPLIED WARRANTY RELATING TO THE SALE AND/OR USE OF NATIONAL PRODUCTS INCLUDING LIABILITY OR WARRANTIES RELATING TO FITNESS FOR A PARTICULAR PURPOSE, MERCHANTABILITY, OR INFRINGEMENT OF ANY PATENT, COPYRIGHT OR OTHER INTELLECTUAL PROPERTY RIGHT.

LIFE SUPPORT POLICY

NATIONAL'S PRODUCTS ARE NOT AUTHORIZED FOR USE AS CRITICAL COMPONENTS IN LIFE SUPPORT DEVICES OR SYSTEMS WITHOUT THE EXPRESS PRIOR WRITTEN APPROVAL OF THE CHIEF EXECUTIVE OFFICER AND GENERAL COUNSEL OF NATIONAL SEMICONDUCTOR CORPORATION. As used herein:

Life support devices or systems are devices which (a) are intended for surgical implant into the body, or (b) support or sustain life and whose failure to perform when properly used in accordance with instructions for use provided in the labeling can be reasonably expected to result in a significant injury to the user. A critical component is any component in a life support device or system whose failure to perform can be reasonably expected to cause the failure of the life support device or system or to affect its safety or effectiveness.

National Semiconductor and the National Semiconductor logo are registered trademarks of National Semiconductor Corporation. All other brand or product names may be trademarks or registered trademarks of their respective holders.

Copyright© 2011 National Semiconductor Corporation

For the most current product information visit us at www.national.com



**National Semiconductor
Americas Technical
Support Center**
Email: support@nsc.com
Tel: 1-800-272-9959

**National Semiconductor Europe
Technical Support Center**
Email: europe.support@nsc.com

**National Semiconductor Asia
Pacific Technical Support Center**
Email: ap.support@nsc.com

**National Semiconductor Japan
Technical Support Center**
Email: jpn.feedback@nsc.com

IMPORTANT NOTICE

Texas Instruments Incorporated and its subsidiaries (TI) reserve the right to make corrections, modifications, enhancements, improvements, and other changes to its products and services at any time and to discontinue any product or service without notice. Customers should obtain the latest relevant information before placing orders and should verify that such information is current and complete. All products are sold subject to TI's terms and conditions of sale supplied at the time of order acknowledgment.

TI warrants performance of its hardware products to the specifications applicable at the time of sale in accordance with TI's standard warranty. Testing and other quality control techniques are used to the extent TI deems necessary to support this warranty. Except where mandated by government requirements, testing of all parameters of each product is not necessarily performed.

TI assumes no liability for applications assistance or customer product design. Customers are responsible for their products and applications using TI components. To minimize the risks associated with customer products and applications, customers should provide adequate design and operating safeguards.

TI does not warrant or represent that any license, either express or implied, is granted under any TI patent right, copyright, mask work right, or other TI intellectual property right relating to any combination, machine, or process in which TI products or services are used. Information published by TI regarding third-party products or services does not constitute a license from TI to use such products or services or a warranty or endorsement thereof. Use of such information may require a license from a third party under the patents or other intellectual property of the third party, or a license from TI under the patents or other intellectual property of TI.

Reproduction of TI information in TI data books or data sheets is permissible only if reproduction is without alteration and is accompanied by all associated warranties, conditions, limitations, and notices. Reproduction of this information with alteration is an unfair and deceptive business practice. TI is not responsible or liable for such altered documentation. Information of third parties may be subject to additional restrictions.

Resale of TI products or services with statements different from or beyond the parameters stated by TI for that product or service voids all express and any implied warranties for the associated TI product or service and is an unfair and deceptive business practice. TI is not responsible or liable for any such statements.

TI products are not authorized for use in safety-critical applications (such as life support) where a failure of the TI product would reasonably be expected to cause severe personal injury or death, unless officers of the parties have executed an agreement specifically governing such use. Buyers represent that they have all necessary expertise in the safety and regulatory ramifications of their applications, and acknowledge and agree that they are solely responsible for all legal, regulatory and safety-related requirements concerning their products and any use of TI products in such safety-critical applications, notwithstanding any applications-related information or support that may be provided by TI. Further, Buyers must fully indemnify TI and its representatives against any damages arising out of the use of TI products in such safety-critical applications.

TI products are neither designed nor intended for use in military/aerospace applications or environments unless the TI products are specifically designated by TI as military-grade or "enhanced plastic." Only products designated by TI as military-grade meet military specifications. Buyers acknowledge and agree that any such use of TI products which TI has not designated as military-grade is solely at the Buyer's risk, and that they are solely responsible for compliance with all legal and regulatory requirements in connection with such use.

TI products are neither designed nor intended for use in automotive applications or environments unless the specific TI products are designated by TI as compliant with ISO/TS 16949 requirements. Buyers acknowledge and agree that, if they use any non-designated products in automotive applications, TI will not be responsible for any failure to meet such requirements.

Following are URLs where you can obtain information on other Texas Instruments products and application solutions:

Products

Audio	www.ti.com/audio
Amplifiers	amplifier.ti.com
Data Converters	dataconverter.ti.com
DLP® Products	www.dlp.com
DSP	dsp.ti.com
Clocks and Timers	www.ti.com/clocks
Interface	interface.ti.com
Logic	logic.ti.com
Power Mgmt	power.ti.com
Microcontrollers	microcontroller.ti.com
RFID	www.ti-rfid.com
OMAP Mobile Processors	www.ti.com/omap
Wireless Connectivity	www.ti.com/wirelessconnectivity

Applications

Communications and Telecom	www.ti.com/communications
Computers and Peripherals	www.ti.com/computers
Consumer Electronics	www.ti.com/consumer-apps
Energy and Lighting	www.ti.com/energy
Industrial	www.ti.com/industrial
Medical	www.ti.com/medical
Security	www.ti.com/security
Space, Avionics and Defense	www.ti.com/space-avionics-defense
Transportation and Automotive	www.ti.com/automotive
Video and Imaging	www.ti.com/video

TI E2E Community Home Page

e2e.ti.com

Mailing Address: Texas Instruments, Post Office Box 655303, Dallas, Texas 75265
Copyright © 2011, Texas Instruments Incorporated