

# LM34923

*LM34923 80V, 600 mA Constant On-Time Buck Switching Regulator*



Literature Number: SNVS695

# LM34923

## 80V, 600 mA Constant On-Time Buck Switching Regulator

### General Description

The LM34923 Step Down Switching Regulator features all of the functions needed to implement a low cost, efficient Buck bias regulator. This high voltage regulator contains an 80V N-Channel MOSFET Switch and a startup regulator. The device is easy to implement and is provided in an MSOP-10 package. The regulator's control scheme uses an on-time inversely proportional to  $V_{IN}$ . This feature results in the operating frequency remaining relatively constant with line and load variations. The control scheme requires no loop compensation, resulting in fast transient response. An intelligent current limit is implemented with a forced off-time which is inversely proportional to  $V_{OUT}$ . This scheme ensures short circuit control while providing minimum foldback. Other features include: Thermal Shutdown, VCC Under Voltage Lock-out, Max Duty Cycle Limiter, a Pre-charge Switch, and a programmable Under Voltage Detector with a status flag output.

### Features

- Operating input voltage range: 6V to 75V
- Integrated 80V, N-Channel Buck Switch
- Internal start-up regulator
- No Loop compensation required
- Ultra-Fast Transient Response
- Operating frequency remains constant with line and load variations
- Adjustable output voltage from 2.5V
- Precision internal reference,  $\pm 2.5\%$
- Intelligent current limit reduces foldback
- Programmable Input UV detector with status flag output
- Pre-charge switch enables bootstrap gate drive with no load
- Thermal shutdown

### Typical Applications

- Non-Isolated Telecommunication Buck Regulator
- Secondary High Voltage Post Regulator
- +42V Automotive Systems

### Package

- MSOP - 10

### Typical Application, Basic Step-Down Regulator

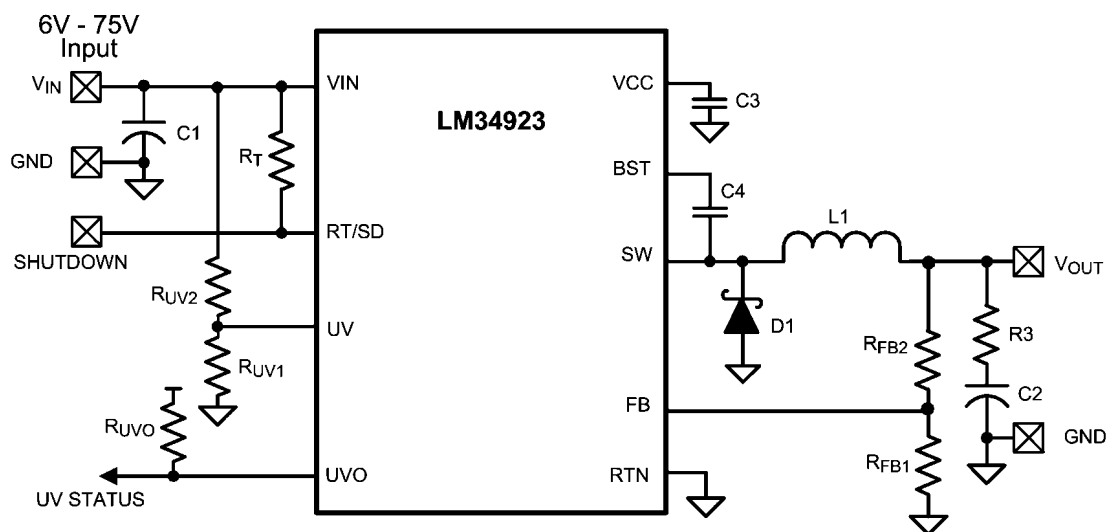

30141701

## Connection Diagram

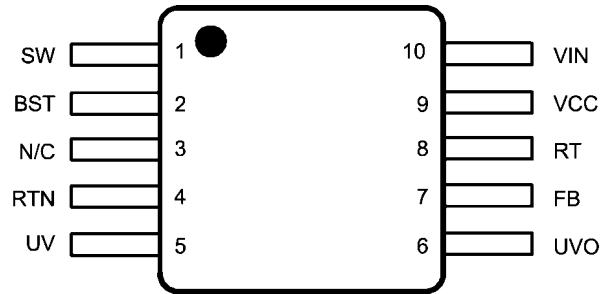

Top View  
10-Lead MSOP

30141702

## Ordering Information

Order Number	Package Type	NSC Package Drawing	Supplied As
LM34923MM	MSOP-10	MUB10A	1000 Units on Tape and Reel
LM34923MMX			3500 Units on Tape and Reel

## Pin Descriptions

Pin	Name	Description	Application Information
1	SW	Switching Node	Power switching node. Connect to the output inductor, re-circulating diode or synchronous FET, and bootstrap capacitor.
2	BST	Boost Pin	An external capacitor is required between the BST and the SW pins (0.01 $\mu$ F or greater ceramic). The BST pin capacitor is charged from Vcc through an internal diode when SW is low.
3	N/C	Do not connect	
4	RTN	Ground pin	Ground for the entire circuit.
5	UV	Input pin for the under voltage indicator	A resistor divider from VIN, or some other system voltage, programs the under-voltage detection threshold. An internal current sink is enabled when UV is below 2.5V to provide hysteresis.
6	UVO	Under voltage status indicator	This open drain output is high when the UV pin voltage is below 2.5V, or when the VCC <sub>UVLO</sub> function or the shutdown function is invoked.
7	FB	Feedback Input from Regulated Output	This pin is connected to the inverting input of the internal regulation comparator. The regulation level is 2.5V.
8	RT/SD	On-time set pin and shutdown input	A resistor between this pin and Vin sets the switch on-time as a function of Vin, and the frequency. The minimum recommended on-time is 200 ns at max input voltage. Taking this pin to ground shuts off the regulator.
9	VCC	Output from the internal high voltage series pass regulator. Regulated at 7.5V.	The internal regulator provides bias supply for the Buck switch gate driver and other internal circuitry. A 1 $\mu$ F ceramic capacitor to ground is required. The regulator is current limited to $\approx$ 30 mA.
10	VIN	Input Voltage	The operating input range is 6V to 75V

## Absolute Maximum Ratings *(Note 1)*

If Military/Aerospace specified devices are required, please contact the National Semiconductor Sales Office/Distributors for availability and specifications.

VIN, UV to RTN	-0.3V to 80V
BST to RTN	-0.3V to 88V
SW to RTN (Steady State)	-1V to $V_{IN} + 0.3V$
BST to VCC	80V
BST to SW	10V
VCC, UVO, RT to RTN	-0.3V to 10V
FB, RT, to RTN	-0.3 to 5V

## ESD Rating *(Note 5)*

Human Body Model	2kV
For soldering specs see:	
www.national.com/ms/MS/MS-SOLDERING.pdf	
Junction Temperature	150°C
Storage Temperature Range	-55°C to +150°C

## Operating Ratings *(Note 1)*

$V_{IN}$	6V to 75V
Operating Junction Temperature	-40°C to + 125°C

**Electrical Characteristics** Specifications with standard type are for  $T_J = 25^\circ\text{C}$  only; limits in **boldface type** apply over the full Operating Junction Temperature ( $T_J$ ) range. Minimum and Maximum limits are guaranteed through test, design, or statistical correlation. Typical values represent the most likely parametric norm at  $T_J = 25^\circ\text{C}$ , and are provided for reference purposes only. Unless otherwise stated the following conditions apply:  $V_{IN} = 48V$  (*Note 3*).

Symbol	Parameter	Conditions	Min	Typ	Max	Units
<b>VCC Supply</b>						
Vcc Reg	Vcc Regulator Output	$V_{in} = 48V$	<b>7.1</b>	7.5	<b>7.9</b>	V
	$V_{in} - V_{cc}$	$V_{IN} = 6V, I_{CC} = 5mA$		240		mV
	Vcc Output Impedance	$V_{in} = 6V$		45		$\Omega$
	Vcc Current Limit	$V_{in} = 48V$ (Note 4)	<b>20</b>	30		mA
	Vcc UVLO	Vcc Increasing		4	<b>4.8</b>	V
	Vcc UVLO hysteresis			450		mV
	Iin Operating current	FB = 3V, $V_{in} = 48V$		1	<b>1.32</b>	mA
	Iin Shutdown Current	RT/SD = 0V		20	<b>70</b>	$\mu\text{A}$
<b>Switch Characteristics</b>						
	Buckswitch $R_{ds(on)}$	$I_{test} = 200\text{ mA}$		0.56	<b>1.1</b>	$\Omega$
	Gate Drive UVLO	$V_{bst} - V_{sw}$ Rising	<b>2.15</b>	3	<b>3.8</b>	V
	Gate Drive UVLO hysteresis			250		mV
	Pre-charge switch voltage	At 1 mA		0.8		V
	Pre-charge switch on-time			150		ns
<b>Current Limit</b>						
	Current Limit Threshold		<b>700</b>	1175	<b>1500</b>	mA
	Current Limit Response Time	$I_{switch} = 1.24A$ , Time to Switch Off		190		ns
$T_{OFF-1}$	OFF time generator (test 1)	FB=0V, $V_{IN} = 75V$		37		$\mu\text{s}$
$T_{OFF-2}$	OFF time generator (test 2)	FB=2.3V, $V_{IN} = 75V$		7.2		$\mu\text{s}$
$T_{OFF-3}$	OFF time generator (test 3)	FB=0V, $V_{IN} = 10V$		5.7		$\mu\text{s}$
$T_{OFF-4}$	OFF time generator (test 4)	FB=2.3V, $V_{IN} = 10V$		1.25		$\mu\text{s}$
<b>On Time Generator</b>						
$T_{ON-1}$	On-Time	$V_{in} = 10V$ $R_{on} = 250K$	<b>2.2</b>	3.3	<b>4.51</b>	$\mu\text{s}$
$T_{ON-2}$	On-Time	$V_{in} = 75V$ $R_{on} = 250K$	<b>300</b>	450	<b>565</b>	ns
	Remote Shutdown Threshold	Voltage at RT/SD rising	<b>0.46</b>	0.9	<b>1.4</b>	V
	Remote Shutdown Hysteresis			60		mV

Symbol	Parameter	Conditions	Min	Typ	Max	Units
<b>Minimum Off Time</b>						
	Minimum Off Time	VIN = 6V		260	<b>347</b>	ns
<b>Regulation and OV Comparators</b>						
	FB Reference Threshold	Internal reference Trip point for switch ON	<b>2.4365</b>	2.5	<b>2.5625</b>	V
	FB Over-Voltage Threshold	Trip point for switch OFF		2.85		V
	FB Bias Current			1		nA
<b>Under Voltage Sensing</b>						
UV <sub>TH</sub>	UV Threshold		<b>2.4</b>	2.5	<b>2.6</b>	V
UV <sub>HYS</sub>	UV Hysteresis Current	UV = 2V	<b>2.7</b>	5	<b>7.3</b>	uA
UV <sub>BIAS</sub>	UV Bias Current	UV = 3V		1		nA
UVO <sub>VOL</sub>	UVO Output Low Voltage	UV = 3V, I <sub>UVO</sub> = 5mA		360	<b>600</b>	mV
UVO <sub>IOH</sub>	UVO Leakage Current	UV = 2V, V <sub>UVO</sub> = 7.8V		1		nA
<b>Thermal Shutdown</b>						
Tsd	Thermal Shutdown Temp.			165		°C
	Thermal Shutdown Hysteresis			20		°C
<b>Thermal Resistance</b>						
θ <sub>JA</sub>	Junction to Ambient	MUA Package		200		°C/W

**Note 1:** Absolute Maximum Ratings are limits beyond which damage to the device may occur. Operating Ratings are conditions under which operation of the device is intended to be functional. For guaranteed specifications and test conditions, see the Electrical Characteristics.

**Note 2:** For detailed information on soldering plastic MSOP packages, refer to the Packaging Data Book available from National Semiconductor Corporation.

**Note 3:** All limits are guaranteed. All electrical characteristics having room temperature limits are tested during production with T<sub>A</sub> = T<sub>J</sub> = 25°C. All hot and cold limits are guaranteed by correlating the electrical characteristics to process and temperature variations and applying statistical process control.

**Note 4:** The V<sub>CC</sub> output is intended as a self bias for the internal gate drive power and control circuits. Device thermal limitations limit external loading.

**Note 5:** The human body model is a 100pF capacitor discharged through a 1.5kΩ resistor into each pin.

# Typical Performance Characteristics

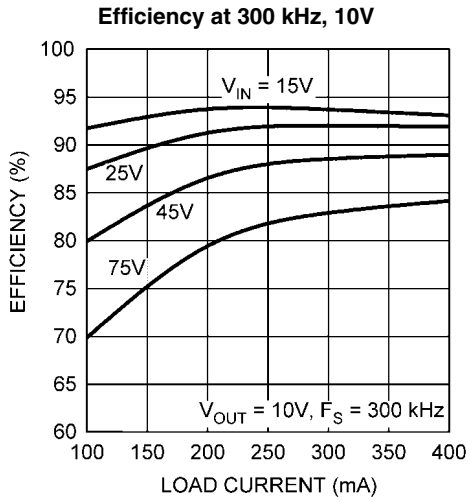

30141724

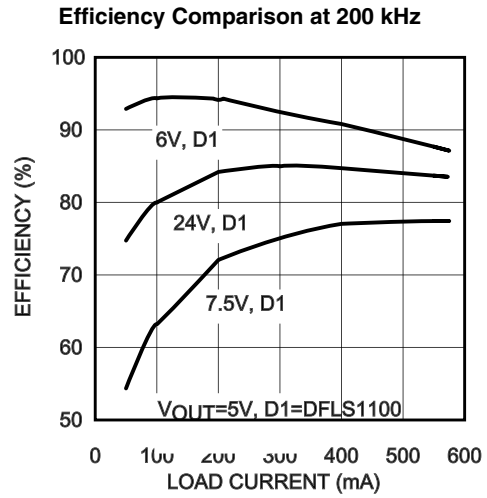

30141767

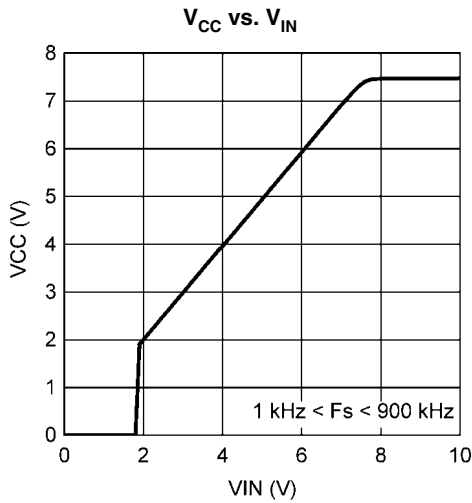

30141725

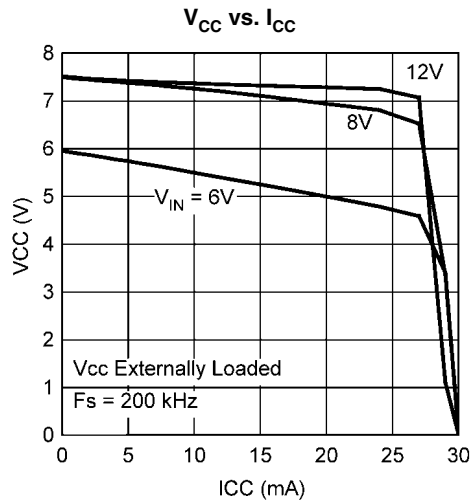

30141707

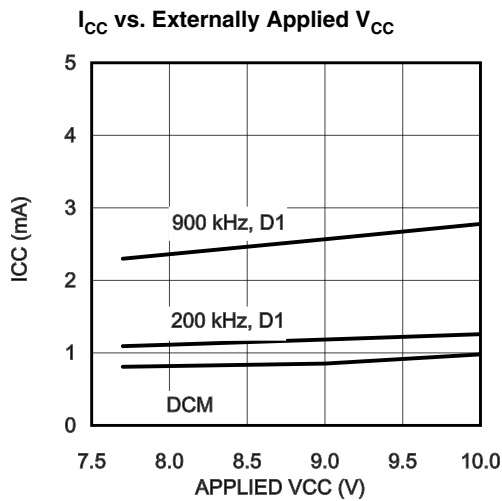

30141765

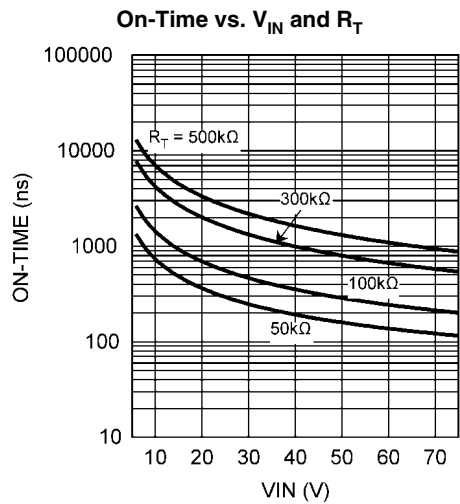

30141727

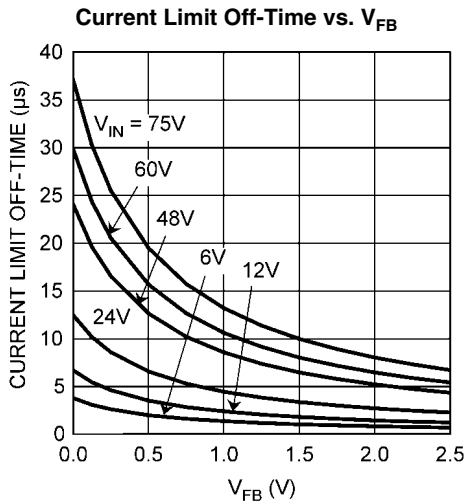

30141738

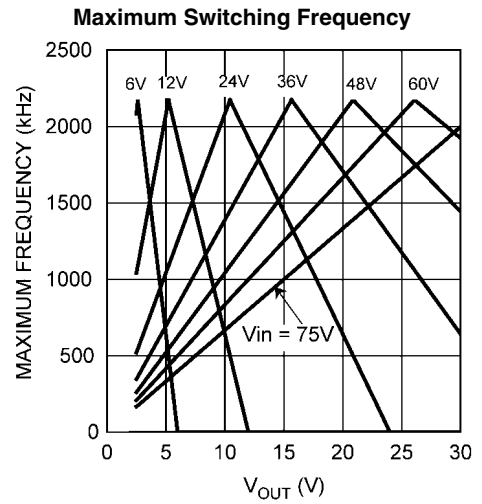

30141739

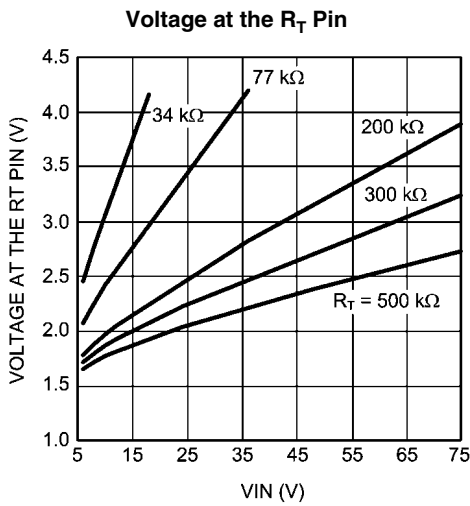

30141740

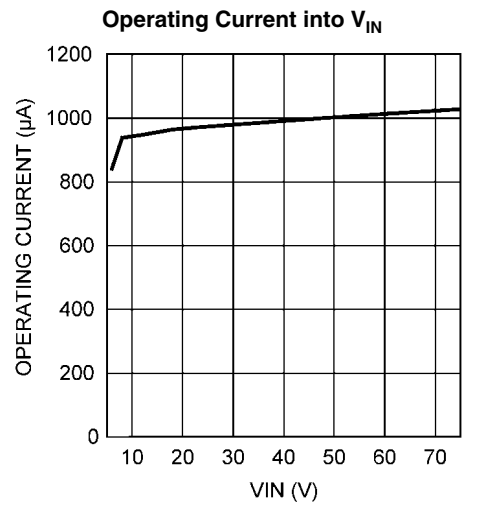

30141741

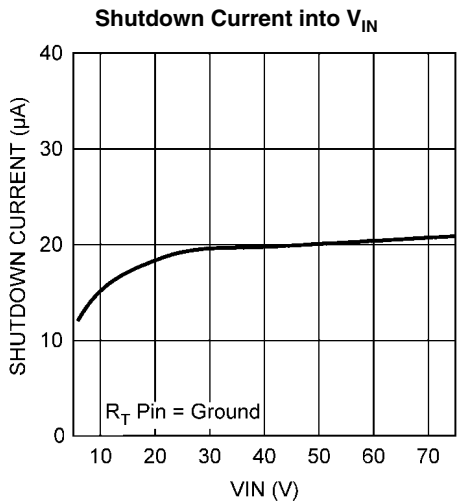

30141742

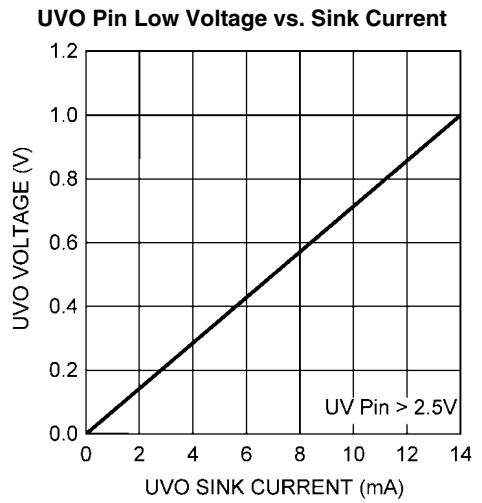

30141743

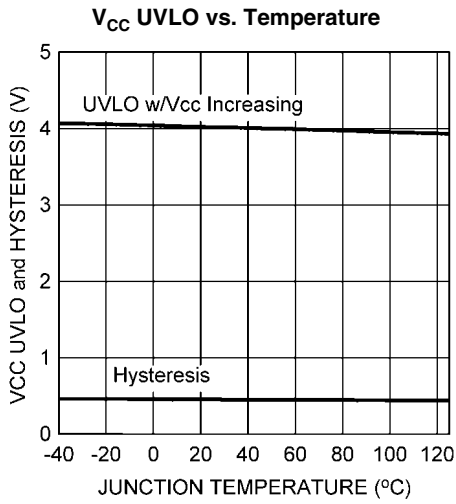

30141745

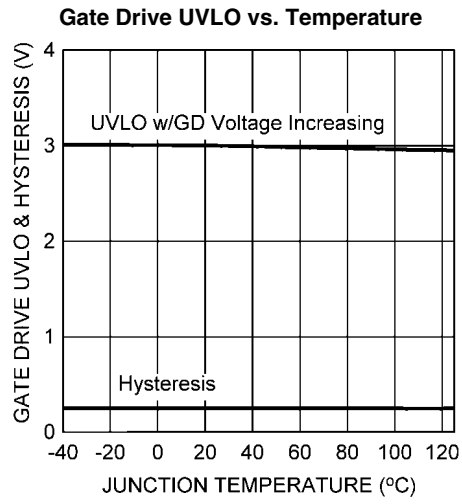

30141746

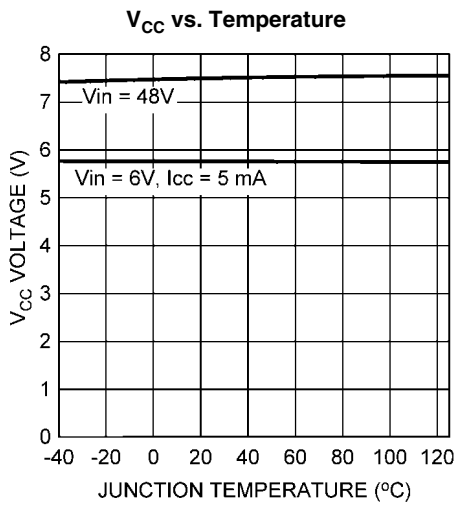

30141747

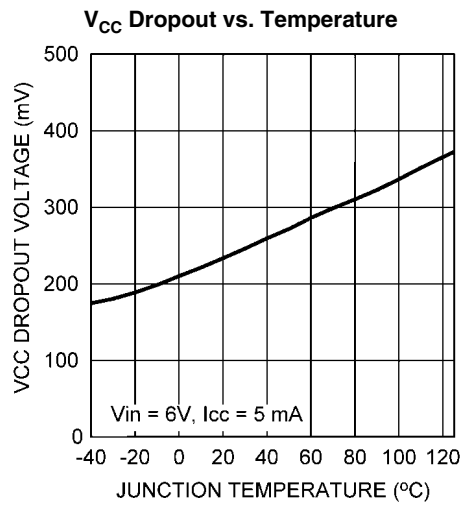

30141759

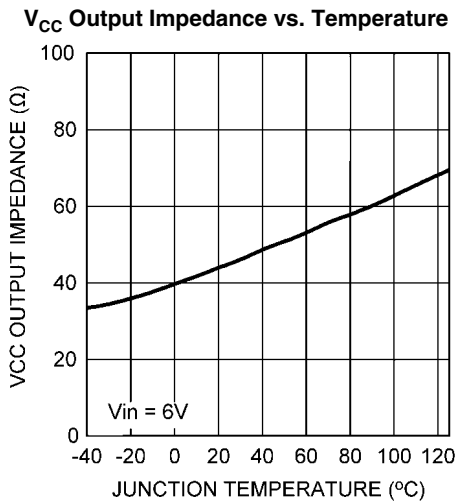

30141748

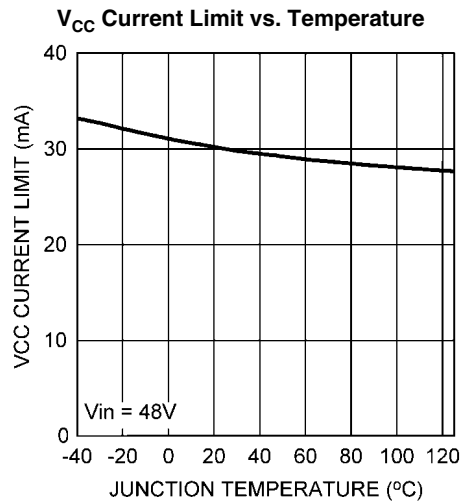

30141749



Reference Voltage vs. Temperature

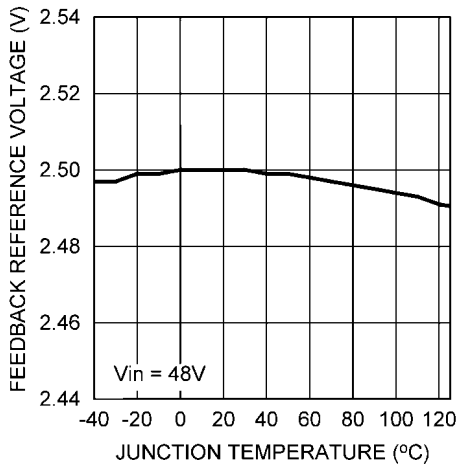

30141750

On-time vs. Temperature

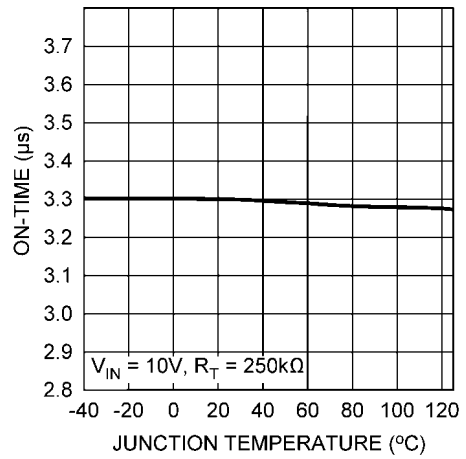

30141751

Minimum Off-time vs. Temperature

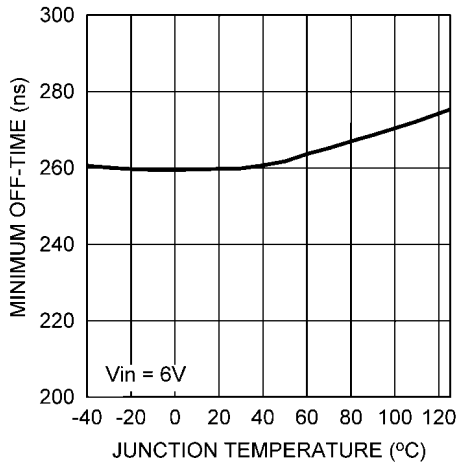

30141752

Current Limit Threshold vs. Temperature

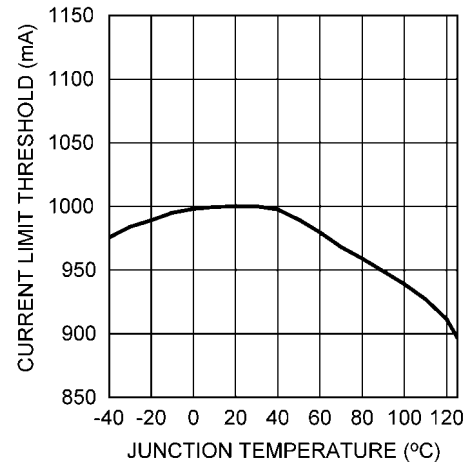

30141753

Current Limit Off-Time vs. Temperature

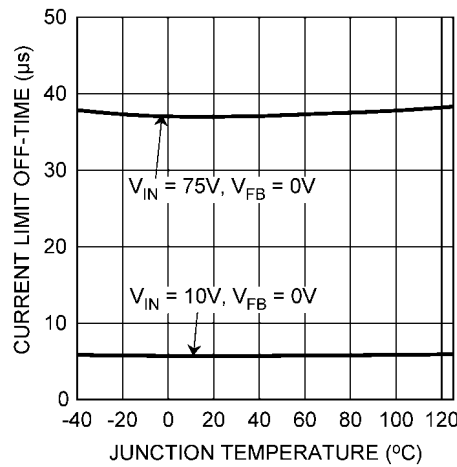

30141760

Operating Current vs. Temperature

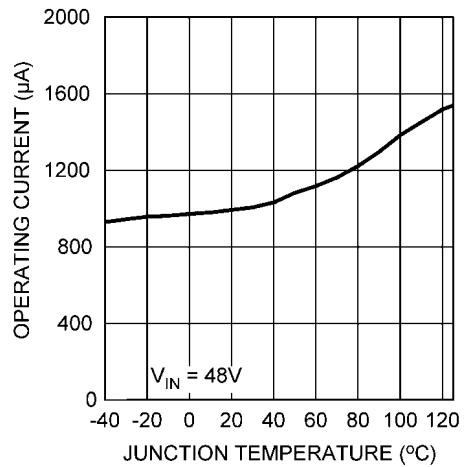

30141754

Shutdown Current vs. Temperature

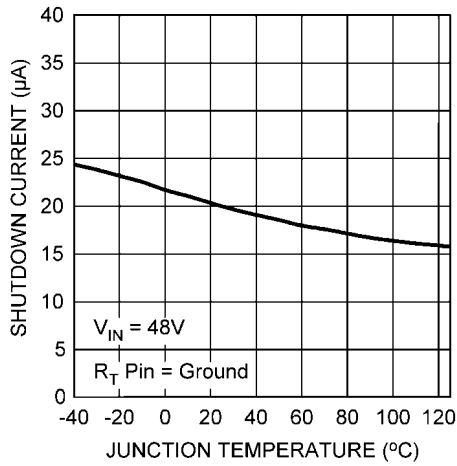

30141755

RT Pin Shutdown Threshold vs. Temperature

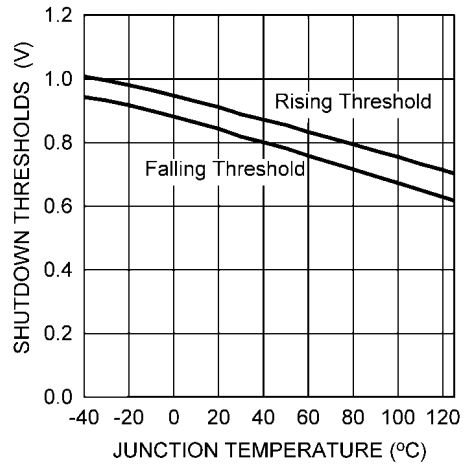

30141756

UV Pin Threshold vs. Temperature

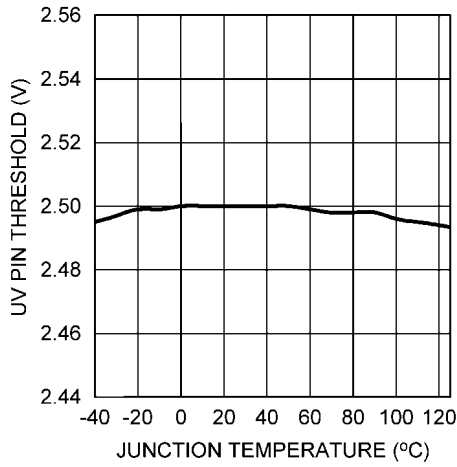

30141761

UV Hysteresis Current vs. Temperature

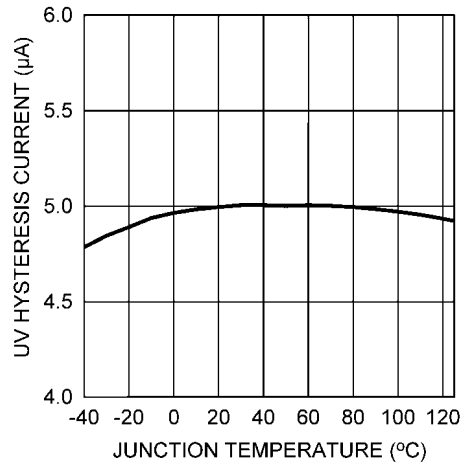

30141762

## Block Diagram

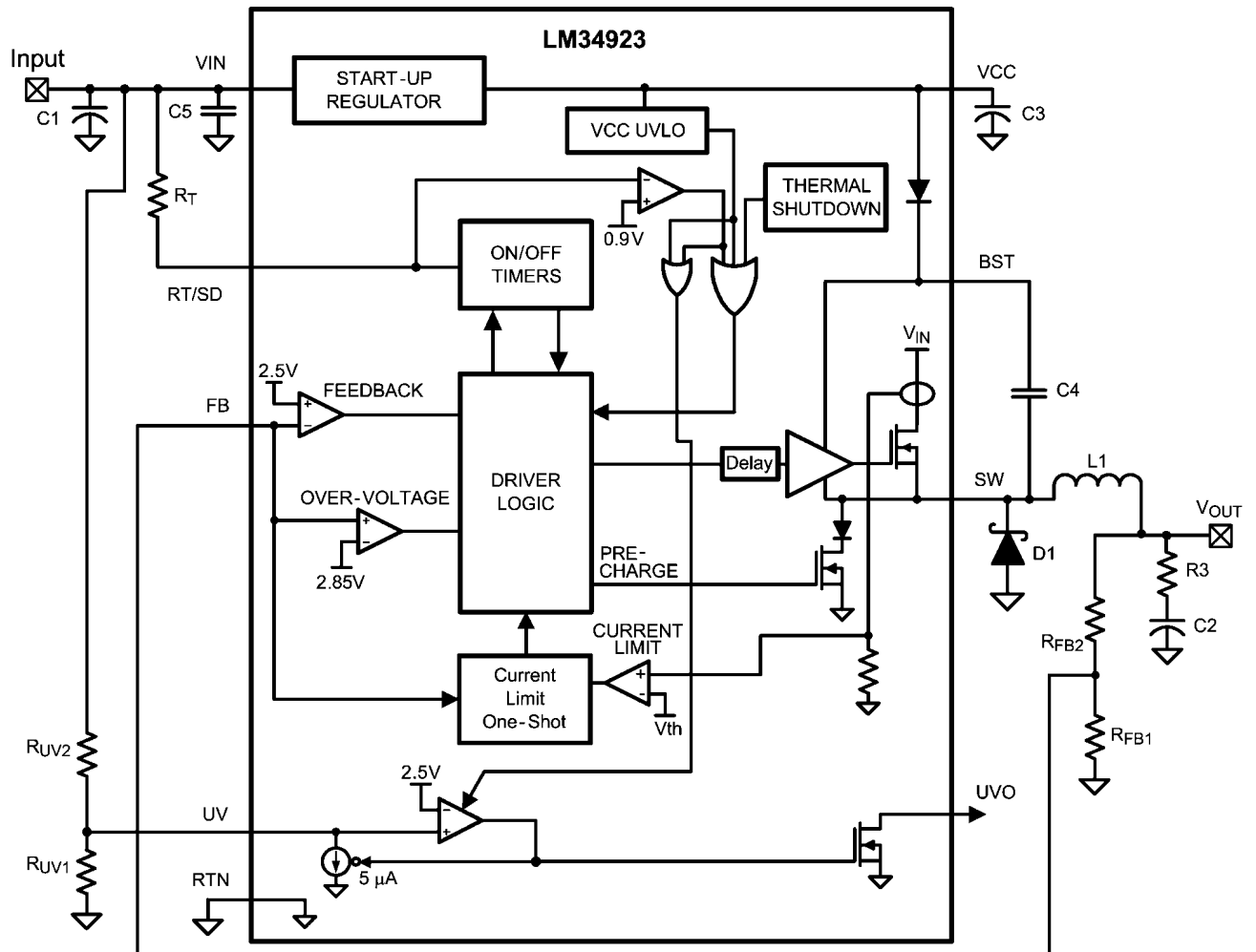

30141710

## Functional Description

The LM34923 Step Down Switching Regulator features all the functions needed to implement a low cost, efficient, Buck bias power converter. This high voltage regulator contains an 80 V N-Channel Buck Switch, is easy to implement and is provided in the MSOP-10 package. The regulator is based on a control scheme using an on-time inversely proportional to  $V_{IN}$ . The control scheme requires no loop compensation. Current limit is implemented with forced off-time, which is inversely proportional to  $V_{OUT}$ . This scheme ensures short circuit control while providing minimum foldback.

The LM34923 can be applied in numerous applications to efficiently regulate down higher voltages. This regulator is well suited for 48 Volt Telecom and the new 42V Automotive power bus ranges. Features include: Thermal Shutdown,  $V_{CC}$  under-voltage lockout, Gate drive under-voltage lockout, Max Duty Cycle limit timer, intelligent current limit off timer, a pre-charge switch, and a programmable under voltage detector with status flag.

## Control Circuit Overview

The LM34923 is a Buck DC-DC regulator that uses a control scheme in which the on-time varies inversely with line voltage ( $V_{IN}$ ). Control is based on a comparator and the on-time one-shot, with the output voltage feedback (FB) compared to an internal reference (2.5V). If the FB level is below the reference the buck switch is turned on for a fixed time determined by the line voltage and a programming resistor ( $R_T$ ). Following the ON period the switch remains off for at least the minimum off-time period of 260 ns. If FB is still below the reference at that time the switch turns on again for another on-time period. This continues until regulation is achieved.

The LM34923 operates in discontinuous conduction mode at light load currents, and continuous conduction mode at heavy load current. In discontinuous conduction mode, current through the output inductor starts at zero and ramps up to a peak during the on-time, then ramps back to zero before the end of the off-time. The next on-time period starts when the voltage at FB falls below the internal reference - until then the inductor current remains zero. In this mode the operating frequency is lower than in continuous conduction mode, and varies with load current. Therefore at light loads the conversion efficiency is maintained, since the switching losses re-

duce with the reduction in load and frequency. The discontinuous operating frequency can be calculated as follows:

$$F = \frac{V_{OUT}^2 \times L \times 1.28 \times 10^{20}}{R_L \times (R_T)^2}$$

where  $R_L$  = the load resistance

In continuous conduction mode, current flows continuously through the inductor and never ramps down to zero. In this mode the operating frequency is greater than the discontinuous mode frequency and remains relatively constant with load and line variations. The approximate continuous mode operating frequency can be calculated as follows:

$$F = \frac{V_{OUT} \times (V_{in} - 0.5V)}{1.25 \times 10^{-10} \times V_{IN} \times (R_T + 500\Omega)} \quad (1)$$

The buck switch duty cycle is approximately equal to:

$$DC = \frac{t_{ON}}{t_{ON} + t_{OFF}} = \frac{V_{OUT}}{V_{IN}} \quad (2)$$

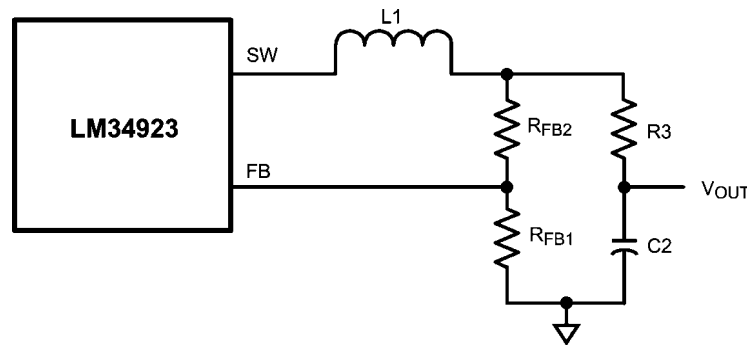

30141713

FIGURE 1. Low Ripple Output Configuration

## Start-Up Regulator ( $V_{CC}$ )

The high voltage bias regulator is integrated within the LM34923. The input pin ( $V_{IN}$ ) can be connected directly to line voltages between 6V and 75V, with transient capability to 80V. The  $V_{CC}$  output is regulated at 7.5V. The  $V_{CC}$  regulator output current is limited at approximately 30 mA.

C3 must be located as close as possible to the  $V_{CC}$  and RTN pins. In applications with a relatively high input voltage, power dissipation in the bias regulator is a concern. An auxiliary voltage of between 7.5V and 10V can be diode connected to the  $V_{CC}$  pin to shut off the  $V_{CC}$  regulator, thereby reducing internal power dissipation. The current required into the  $V_{CC}$

The output voltage ( $V_{OUT}$ ) is programmed by two external resistors as shown in the Block Diagram. The regulation point can be calculated as follows:

$$V_{OUT} = 2.5 \times (R_{FB1} + R_{FB2}) / R_{FB1}$$

The LM34923 regulates the output voltage based on ripple voltage at the feedback input, requiring a minimum amount of ESR for the output capacitor C2. A minimum of 25mV to 50mV of ripple voltage at the feedback pin (FB) is required for the LM34923. In cases where the capacitor ESR is too small, additional series resistance may be required (R3 in the Block Diagram).

For applications where lower output voltage ripple is required the output can be taken directly from a low ESR output capacitor, as shown in Figure 1. However, R3 slightly degrades the load regulation.

pin depends on the voltage applied to  $V_{CC}$  and the switching frequency. See the graph " $I_{CC}$  vs. Externally Applied  $V_{CC}$ ." Internally a diode connects  $V_{CC}$  to  $V_{IN}$  requiring that the auxiliary voltage be less than  $V_{IN}$ .

The turn-on sequence is shown in Figure 2. During the initial delay (t1)  $V_{CC}$  ramps up at a rate determined by its current limit and C3 while internal circuitry stabilizes. When  $V_{CC}$  reaches the upper threshold of its under-voltage lock-out, the buckswitch is enabled. The inductor current increases to the current limit threshold ( $I_{LIM}$ ) and during t2  $V_{OUT}$  increases as the output capacitor charges up. When  $V_{OUT}$  reaches the intended voltage the average inductor current decreases (t3) to the nominal load current ( $I_O$ ).

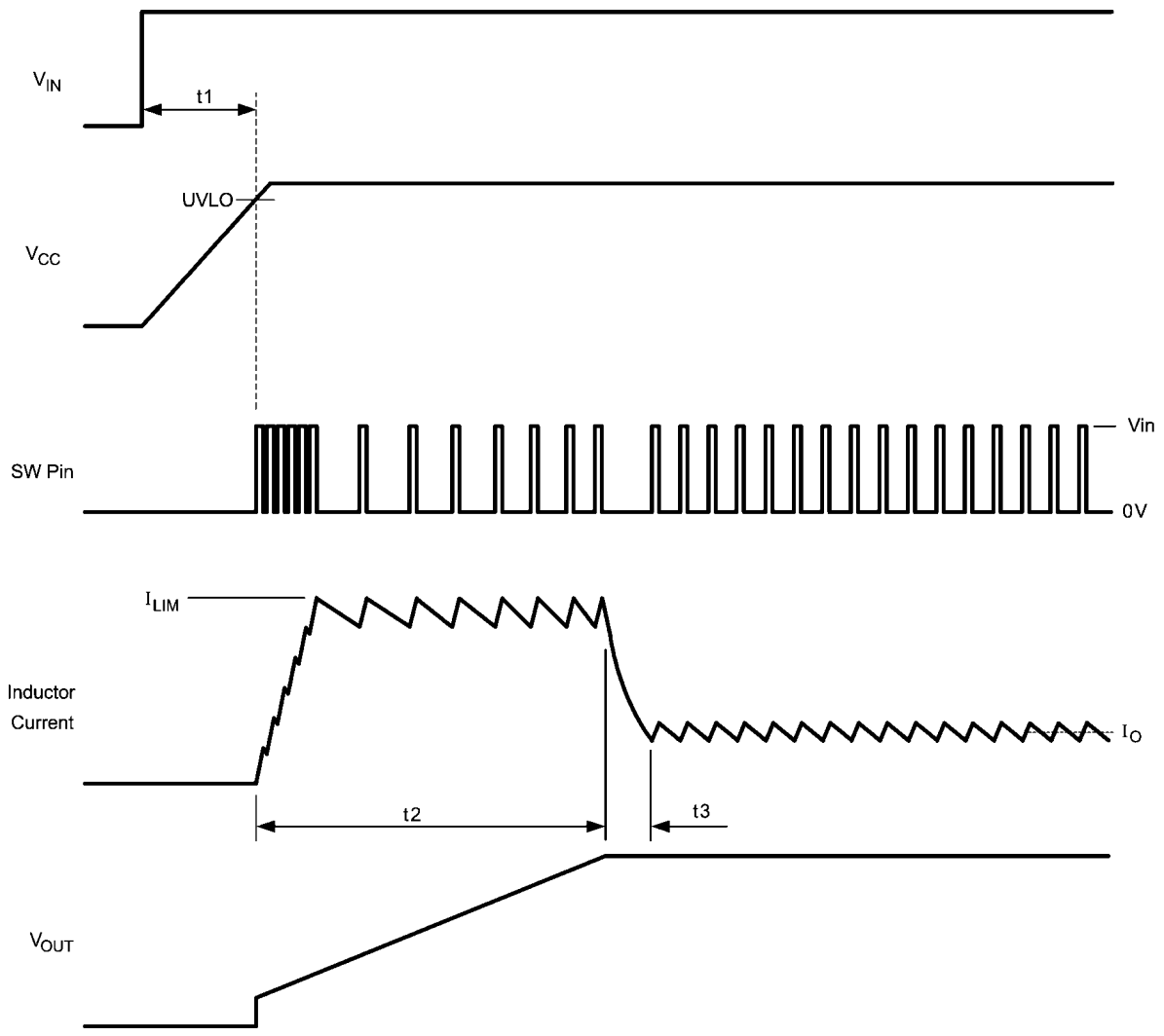

30141714

FIGURE 2. Startup Sequence

## Regulation Comparator

The feedback voltage at FB is compared to an internal 2.5V reference. In normal operation (the output voltage is regulated), an on-time period is initiated when the voltage at FB falls below 2.5V. The buck switch stays on for the on-time, causing the FB voltage to rise above 2.5V. After the on-time period, the buck switch stays off until the FB voltage again falls below 2.5V. During start-up, the FB voltage will be below 2.5V at the end of each on-time, resulting in the minimum off-time of 260 ns.

## Over-Voltage Comparator

The feedback voltage at FB is compared to an internal 2.85V reference. If the voltage at FB rises above 2.85V the on-time pulse is immediately terminated. This condition can occur if the input voltage, or the output load, change suddenly. The buck switch will not turn on again until the voltage at FB falls below 2.5V.

## On-Time Generator and Shutdown

The on-time for the LM34923 is determined by the  $R_T$  resistor, and is inversely proportional to the input voltage ( $V_{IN}$ ), resulting in a nearly constant frequency as  $V_{IN}$  is varied over its range. The on-time equation for the LM34923 is:

$$T_{ON} = \frac{1.25 \times 10^{-10} \times (R_T + 500\Omega) + 30 \text{ ns}}{(V_{IN} - 0.5V)} \quad (3)$$

$R_T$  should be selected for a minimum on-time (at maximum  $V_{IN}$ ) greater than 200 ns, for proper current limit operation. This requirement limits the maximum frequency for each application, depending on  $V_{IN}$  and  $V_{OUT}$ .

The LM34923 can be remotely disabled by taking the RT/SD pin to ground. See [Figure 3](#). The voltage at the RT/SD pin is between 1.5 and 5.0 volts, depending on  $V_{IN}$  and the value of the  $R_T$  resistor.

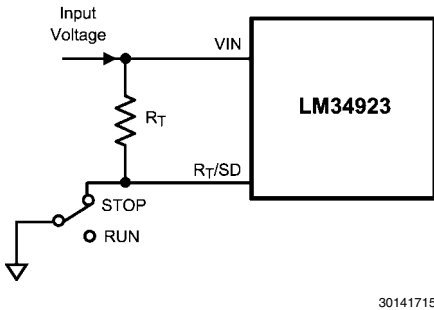

FIGURE 3. Shutdown Implementation

## Current Limit

The LM34923 contains an intelligent current limit OFF timer. If the current in the Buck switch reaches the current limit threshold, the present cycle is immediately terminated, and a non-resettable OFF timer is triggered. The length of off-time is controlled by the FB voltage and  $V_{IN}$  (see the graph Current Limit Off-Time vs.  $V_{FB}$ ). When  $FB = 0V$ , a maximum off-time is required. This condition occurs when the output is shorted, and during the initial part of start-up. This amount of time ensures safe short circuit operation up to the maximum input voltage of 75V. In cases of overload where the FB voltage is above zero volts (not a short circuit) the required current limit off-time is less. Reducing the off-time during less severe overloads reduces the amount of foldback, recovery time, and the start-up time. The off-time in microseconds is calculated from the following equation:

$$T_{OFF} = \frac{(V_{IN} + 1.83V) \times 0.28}{(V_{FB} \times 1.05) + 0.58}$$

The current limit sensing circuit is blanked for the first 50-70 ns of each on-time so it is not falsely tripped by the current surge which occurs at turn-on. The current surge is required by the re-circulating diode (D1) for its turn-off recovery.

## N - Channel Buck Switch and Driver

The LM34923 integrates an N-Channel Buck switch and associated floating high voltage gate driver. The gate driver circuit works in conjunction with an external bootstrap capacitor and an internal high voltage diode. A 0.01  $\mu F$  ceramic capacitor (C4) connected between the BST pin and SW pin provides the voltage to the driver during the on-time.

During each off-time, the SW pin is at approximately 0V, and the bootstrap capacitor charges from Vcc through the internal diode. The minimum OFF timer, set to 260 ns, ensures a minimum time each cycle to recharge the bootstrap capacitor.

The internal pre-charge switch at the SW pin is turned on for  $\approx 150$  ns during the minimum off-time period, ensuring sufficient voltage exists across the bootstrap capacitor for the on-time. This feature helps prevent operating problems which can occur during very light load conditions, involving a long off-time, during which the voltage across the bootstrap capacitor could otherwise reduce below the Gate Drive UVLO threshold. The pre-charge switch also helps prevent startup problems which can occur if the output voltage is pre-charged prior to turn-on. After current limit detection, the pre-charge switch is turned on for the entire duration of the forced off-time.

## Under Voltage Detector

The Under Voltage Detector can be used to monitor the input voltage, or any other system voltage as long as the voltage at the UV pin does not exceed its maximum rating.

The Under Voltage Output indicator pin (UVO) is connected to the drain of an internal N-channel MOSFET capable of sustaining 10V in the off-state. An external pull-up resistor is required at UVO to an appropriate voltage to indicate the status to downstream circuitry. The off-state voltage at the UVO pin can be higher or lower than the voltage at VIN, but must not exceed 10V.

The UVO pin switches low when the voltage at the UV input pin is above its threshold. Typically the monitored voltage threshold is set with a resistor divider ( $R_{UV1}$ ,  $R_{UV2}$ ) as shown in the Block Diagram. When the voltage at the UV pin is below its threshold, the internal 5  $\mu A$  current source at UV is enabled. As the input voltage increases, taking UV above its threshold, the current source is disabled, raising the voltage at UV to provide threshold hysteresis.

The UVO output is high when the VCC voltage is below its UVLO threshold, or when the LM34923 is shutdown using the RT/SD pin (see Figure 3), regardless of the voltage at the UV pin.

## Thermal Protection

The LM34923 should be operated so the junction temperature does not exceed 125°C during normal operation. An internal Thermal Shutdown circuit is provided to shutdown the LM34923 in the event of a higher than normal junction temperature. When activated, typically at 165°C, the controller is forced into a low power reset state by disabling the buck switch. This feature prevents catastrophic failures from accidental device overheating. When the junction temperature reduces below 145°C (typical hysteresis = 20°C) normal operation is resumed.

## Applications Information

### SELECTION OF EXTERNAL COMPONENTS

A guide for determining the component values is illustrated with a design example. Refer to the Block Diagram. The following steps will configure the LM34923 for:

- Input voltage range ( $V_{in}$ ): 15V to 75V
- Output voltage ( $V_{OUT}$ ): 10V
- Load current (for continuous conduction mode): 100 mA to 400 mA
- Switching Frequency: 300 kHz

**$R_{FB1}$ ,  $R_{FB2}$ :**  $V_{OUT} = V_{FB} \times (R_{FB1} + R_{FB2}) / R_{FB1}$ , and since  $V_{FB} = 2.5V$ , the ratio of  $R_{FB2}$  to  $R_{FB1}$  calculates as 3:1. Standard values of 3.01 k $\Omega$  and 1.00 k $\Omega$  are chosen. Other values could be used as long as the 3:1 ratio is maintained.

**$F_s$  and  $R_T$ :** Unless the application requires a specific frequency, the choice of frequency is generally a compromise. A higher frequency allows for a smaller inductor, input capacitor, and output capacitor (both in value and physical size), while providing a lower conversion efficiency. A lower frequency provides higher efficiency, but generally requires higher values for the inductor, input capacitor and output capacitor. The maximum allowed switching frequency for the LM34923 is limited by the minimum on-time (200 ns) at the maximum input voltage, and by the minimum off-time (260 ns) at the minimum input voltage. The maximum frequency limit for each application is defined by the following two calculations:

$$F_{S(\max)1} = \frac{V_{OUT}}{V_{IN(\max)} \times 200 \text{ ns}}$$

$$F_{S(\max)2} = \frac{V_{IN(\min)} - V_{OUT}}{V_{IN(\min)} \times 260 \text{ ns}}$$

The maximum allowed frequency is the lesser of the two above calculations. See the graph "Maximum Switching Frequency". For this exercise,  $F_{S(\max)1}$  calculates to 667 kHz, and  $F_{S(\max)2}$  calculates to 1.28 MHz. Therefore the maximum allowed frequency for this example is 667 kHz, which is greater than the 300 kHz specified for this design. Using Equation 1, RT calculates to 258 k $\Omega$ . A standard value 261 k $\Omega$  resistor is used. The minimum on-time calculates to 469 ns, and the maximum on-time calculates to 2.28  $\mu$ s.

**L1:** The main parameter affected by the inductor is the output current ripple amplitude. The choice of inductor value therefore depends on both the minimum and maximum load currents, keeping in mind that the maximum ripple current occurs at maximum  $V_{IN}$ .

**a) Minimum load current:** To maintain continuous conduction at minimum  $I_O$  (100 mA) if a flyback diode is used, the ripple amplitude ( $I_{OR}$ ) must be less than 200 mA p-p so the lower peak of the waveform does not reach zero. L1 is calculated using the following equation:

$$L1 = \frac{V_{OUT} \times (V_{IN} - V_{OUT})}{I_{OR} \times F_s \times V_{IN}}$$

At  $V_{IN} = 75V$ , L1(min) calculates to 146 $\mu$ H. The next larger standard value (150  $\mu$ H) is chosen and with this value  $I_{OR}$  calculates to 195 mA p-p at  $V_{IN} = 75V$ , and 75 mA p-p at  $V_{IN} = 15V$ .

**b) Maximum load current:** At a load current of 400 mA, the peak of the ripple waveform must not reach the minimum guaranteed value of the LM34923's current limit threshold (700 mA). Therefore the ripple amplitude must be less than 600 mA p-p, which is already satisfied in the above calculation. With L1 = 150  $\mu$ H, at maximum  $V_{IN}$  and  $I_O$ , the peak of the ripple is 498 mA. While L1 must carry this peak current without saturating or exceeding its temperature rating, it also must be capable of carrying the maximum guaranteed value of the LM34923's current limit threshold without saturating, since the current limit is reached during startup.

The DC resistance of the inductor should be as low as possible. For example, if the inductor's DCR is 0.5 ohm, the power dissipated at maximum load current is 0.08W. While small, it is not insignificant compared to the load power of 4W.

**C3:** The capacitor on the  $V_{CC}$  output provides not only noise filtering and stability, but its primary purpose is to prevent false triggering of the  $V_{CC}$  UVLO at the buck switch on/off transitions. C3 should be no smaller than 1  $\mu$ F.

**C2 and R3:** When selecting the output filter capacitor C2, the items to consider are ripple voltage due to its ESR, ripple voltage due to its capacitance, and the nature of the load.

A low ESR for C2 is generally desirable so as to minimize power losses and heating within the capacitor. However, the regulator requires a minimum amount of ripple voltage at the feedback input for proper loop operation. For the LM34923 the minimum ripple required at pin 7 is 25 mV p-p, requiring a minimum ripple at  $V_{OUT}$  of 100 mV for this example. Since

the minimum ripple current (at minimum  $V_{IN}$ ) is 75 mA p-p, the minimum ESR required at  $V_{OUT}$  is 100 mV/75 mA = 1.33 $\Omega$ . Since quality capacitors for SMPS applications have an ESR considerably less than this, R3 is inserted as shown in the Block Diagram. R3's value, along with C2's ESR, must result in at least 25 mV p-p ripple at pin 7. See the Low Output Ripple Configuration section for techniques to reduce the output ripple voltage.

**D1:** A power Schottky diode is recommended. Ultra-fast recovery diodes are not recommended as the high speed transitions at the SW pin may inadvertently affect the IC's operation through external or internal EMI. The important parameters are reverse recovery time and forward voltage. The reverse recovery time determines how long the reverse current surge lasts with each turn-on of the internal buck switch. The forward voltage drop affects efficiency. The diode's reverse voltage rating must be at least as great as the maximum input voltage, plus ripple and transients, and its current rating must be at least as great as the maximum current limit specification. The diode's average power dissipation is calculated from:

$$P_{D1} = V_F \times I_{OUT} \times (1-D) \quad (4)$$

Where  $V_F$  is the diode's forward voltage drop, and D is the on-time duty cycle.

**C1:** This capacitor's purpose is to supply most of the switch current during the on-time, and limit the voltage ripple at  $V_{IN}$ , on the assumption that the voltage source feeding  $V_{IN}$  has an output impedance greater than zero. At maximum load current, when the buck switch turns on, the current into the  $V_{IN}$  pin suddenly increases to the lower peak of the output current waveform, ramp up to the peak value, then drop to zero at turn-off. The average input current during this on-time is the load current (400 mA). For a worst case calculation, C1 must supply this average load current during the maximum on-time. To keep the input voltage ripple to less than 1V (for this exercise), C1 calculates to:

$$C1 = \frac{I \times t_{ON}}{\Delta V} = \frac{0.4A \times 2.28 \mu s}{1V} = 0.91 \mu F$$

Quality ceramic capacitors in this value have a low ESR which adds only a few millivolts to the ripple. It is the capacitance which is dominant in this case. To allow for the capacitor's tolerance, temperature effects, and voltage effects, a 1.0  $\mu$ F, 100V, X7R capacitor is used.

**C4:** The recommended value is 0.01 $\mu$ F for C4, as this is appropriate in the majority of applications. A high quality ceramic capacitor, with low ESR is recommended as C4 supplies the surge current to charge the buck switch gate at turn-on. A low ESR also ensures a quick recharge during each off-time.

**C5:** This capacitor helps avoid supply voltage transients and ringing due to long lead inductance at  $V_{IN}$ . A low ESR, 0.1 $\mu$ F ceramic chip capacitor is recommended, located close to the LM34923.

**UV and UVO pins:** The Under Voltage Detector function is used to monitor a system voltage, such as the input voltage at  $V_{IN}$ , by connecting the UV pin to two resistors ( $R_{UV1}$ ,  $R_{UV2}$ ) as shown in the Block Diagram. When the voltage at the UV pin increases above its threshold the UVO pin switches low. The UVO pin is high when the voltage at the UV input pin is below its threshold. Hysteresis is provided by the internal 5 $\mu$ A current source which is enabled when the voltage at the UV pin is below its threshold. The resistor values are calculated using the following procedure:

Choose the upper and lower thresholds ( $V_{UVH}$  and  $V_{UVL}$ ) at  $V_{IN}$ .

$$R_{UV2} = \frac{V_{UVH} - V_{UVL}}{5 \mu A} = \frac{V_{UV(HYS)}}{5 \mu A}$$

$$R_{UV1} = \frac{R_{UV2} \times 2.5V}{V_{UVL} - 2.5V}$$

As an example, assume the application requires the following thresholds:  $V_{UVH} = 15V$  and  $V_{UVL} = 14V$ . Therefore  $V_{UV(HYS)} = 1V$ . The resistor values calculate to:

$$R_{UV2} = 200k\Omega, R_{UV1} = 43.5k\Omega \quad (5)$$

Capacitor C6 is added to filter noise and ripple, which may be present on the  $V_{IN}$  line. Where the resistor values are known, the threshold voltages and hysteresis are calculated from the following:

$$V_{UVH} = 2.5V + [R_{UV2} \times (\frac{2.5V}{R_{UV1}} + 5 \mu A)]$$

$$V_{UVL} = 2.5V \times \frac{(R_{UV1} + R_{UV2})}{R_{UV1}}$$

$$V_{UV(HYS)} = R_{UV2} \times 5 \mu A \quad (6)$$

The pull-up voltage for the UVO output can be any voltage under 10V. The maximum continuous current into the UVO output pin should not exceed 5 mA.

#### FINAL CIRCUIT

The final circuit is shown in Figure 4. The circuit was tested, and the resulting performance is shown in Figure 6 and Figure 5.

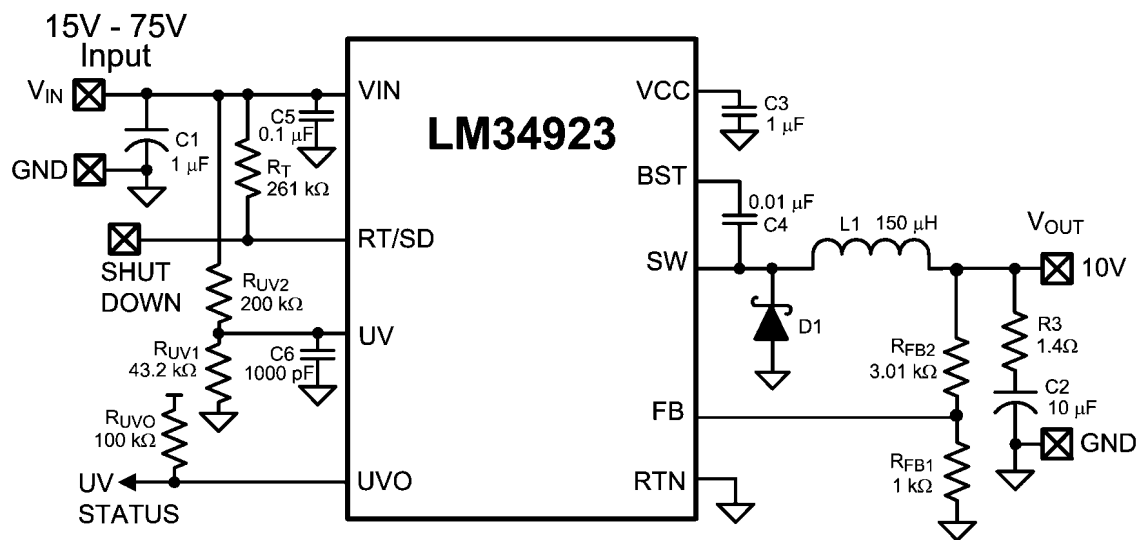

30141718

FIGURE 4. LM34923 Example Circuit



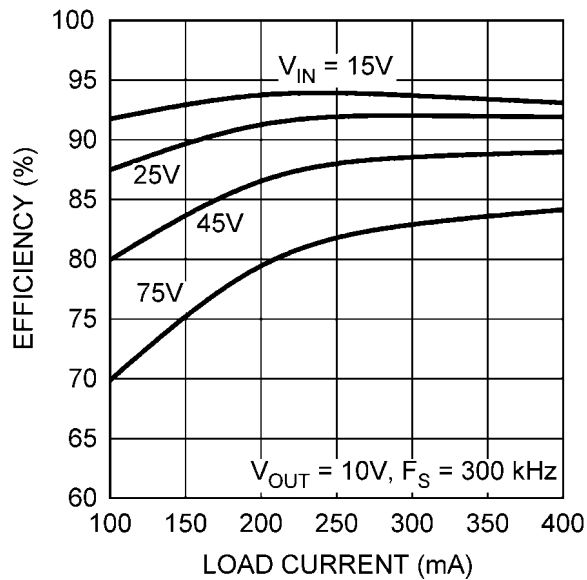

30141724

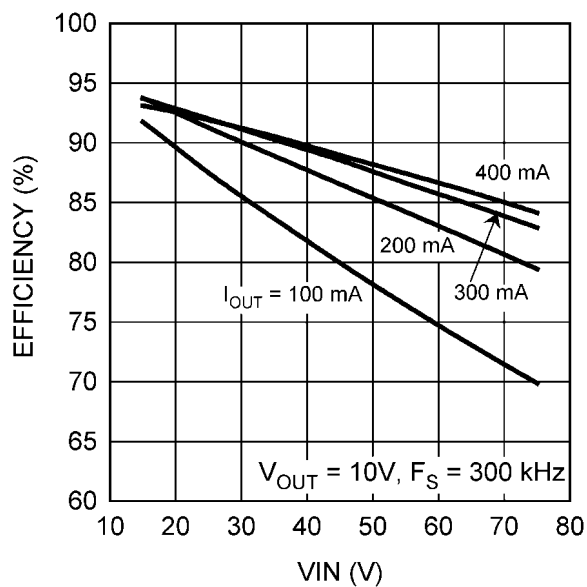
FIGURE 5. Efficiency vs. Load Current and  $V_{IN}$ 

30141728

FIGURE 6. Efficiency vs.  $V_{IN}$ 

#### LOW OUTPUT RIPPLE CONFIGURATIONS

For applications where low output ripple is required, the following options can be used to reduce or nearly eliminate the ripple.

**a) Reduced ripple configuration:** In *Figure 7*,  $C_{ff}$  is added across  $R_{FB2}$  to AC-couple the ripple at  $V_{OUT}$  directly to the FB pin. This allows the ripple at  $V_{OUT}$  to be reduced to a minimum of 25 mVp-p by reducing  $R_3$ , since the ripple at  $V_{OUT}$  is not attenuated by the feedback resistors. The minimum value for  $C_{ff}$  is determined from:

$$C_{ff} = \frac{3 \times t_{ON(max)}}{(R_{FB1} // R_{FB2})}$$

where  $t_{ON(max)}$  is the maximum on-time, which occurs at the minimum input voltage. The next larger standard value capacitor should be used for  $C_{ff}$ .

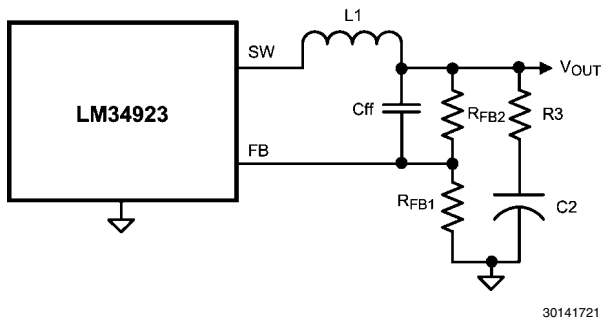

30141721

FIGURE 7. Reduced Ripple Configuration

**b) Minimum ripple configuration:** If the application requires a lower value of ripple ( $<10$  mVp-p), the circuit of [Figure 8](#) can be used. R3 is removed, and the resulting output ripple voltage is determined by the inductor's ripple current and C2's characteristics. RA and CA are chosen to generate a sawtooth waveform at their junction, and that voltage is AC-coupled to the FB pin via CB. To determine the values for RA, CA and CB, use the following procedure:

$$\text{Calculate } V_A = V_{OUT} - (V_{SW} \times (1 - (V_{OUT}/V_{IN(\min)})))$$

where  $V_{SW}$  is the absolute value of the voltage at the SW pin during the off-time. If a Schottky diode is used for the flyback function, the off-time voltage is in the range of 0.5V to 1V, depending on the specific diode used, and the maximum load current.  $V_A$  is the DC voltage at the RA/CA junction, and is used in the next equation.

$$\text{- Calculate } RA \times CA = (V_{IN(\min)} - V_A) \times t_{ON}/\Delta V$$

where  $t_{ON}$  is the maximum on-time (at minimum input voltage), and  $\Delta V$  is the desired ripple amplitude at the RA/CA junction (typically 40-50 mV). RA and CA are then chosen from standard value components to satisfy the above product. Typically CA is 1000 pF to 5000 pF, and RA is 10 k $\Omega$  to 300 k $\Omega$ . CB is then chosen large compared to CA, typically 0.1  $\mu$ F.

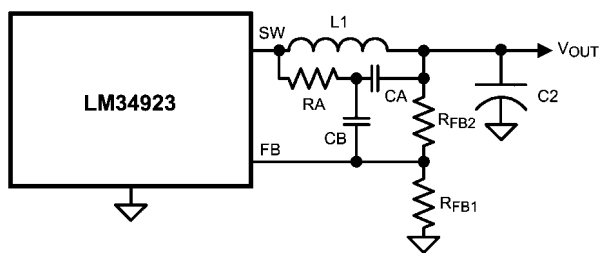

30141722

FIGURE 8. Minimum Output Ripple Using Ripple Injection

**c) Alternate minimum ripple configuration:** The circuit in [Figure 9](#) is the same as that in the Block Diagram, except the output voltage is taken from the junction of R3 and C2. The ripple at  $V_{OUT}$  is determined by the inductor's ripple current

and C2's characteristics. However, R3 slightly degrades the load regulation. This circuit may be suitable if the load current is fairly constant.

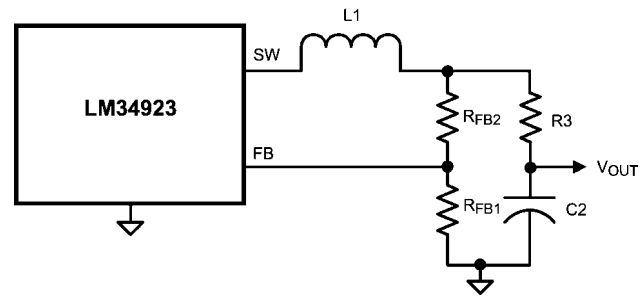

30141723

FIGURE 9. Alternate Minimum Output Ripple

## PC Board Layout

The LM34923 regulation, over-voltage, and current limit comparators are very fast, and respond to short duration noise pulses. Layout considerations are therefore critical for optimum performance. The layout must be as neat and compact as possible, and all of the components must be as close as possible to the associated pins. The two major current loops have currents which switch very fast, and so the loops should be as small as possible to minimize conducted and radiated EMI. The first loop is formed by C1, through VIN to the SW pin, L1, C2, and back to C1. The second loop is formed by L1, C2, D1, and back to L1. Since a current equal to the load current switches between these two loops with each transition from on-time to off-time and back to on-time, it is imperative that the ground end of C1 have a short and direct connection to D1's anode, without going through vias or a lengthy route. The power dissipation in the LM34923 can be approximated by determining the total conversion loss ( $P_{IN} - P_{OUT}$ ), and then subtracting the power losses in D1, and in the inductor. The power loss in the diode is approximately:

$$P_{D1} = I_{OUT} \times V_F \times (1-D)$$

where  $V_F$  is the diode's forward voltage drop, and D is the on-time duty cycle.

$$P_{L1} = I_{OUT}^2 \times R_L \times 1.1$$

where  $R_L$  is the inductor's DC resistance, and the 1.1 factor is an approximation for the AC losses. If it is expected that the internal dissipation of the LM34923 will produce excessive junction temperatures during normal operation, good use of the PC board's ground plane can help to dissipate heat. Additionally the use of wide PC board traces, where possible, can help conduct heat away from the IC. Judicious positioning of the PC board within the end product, along with the use of any available air flow (forced or natural convection) can help reduce the junction temperature.

**Physical Dimensions** inches (millimeters) unless otherwise noted

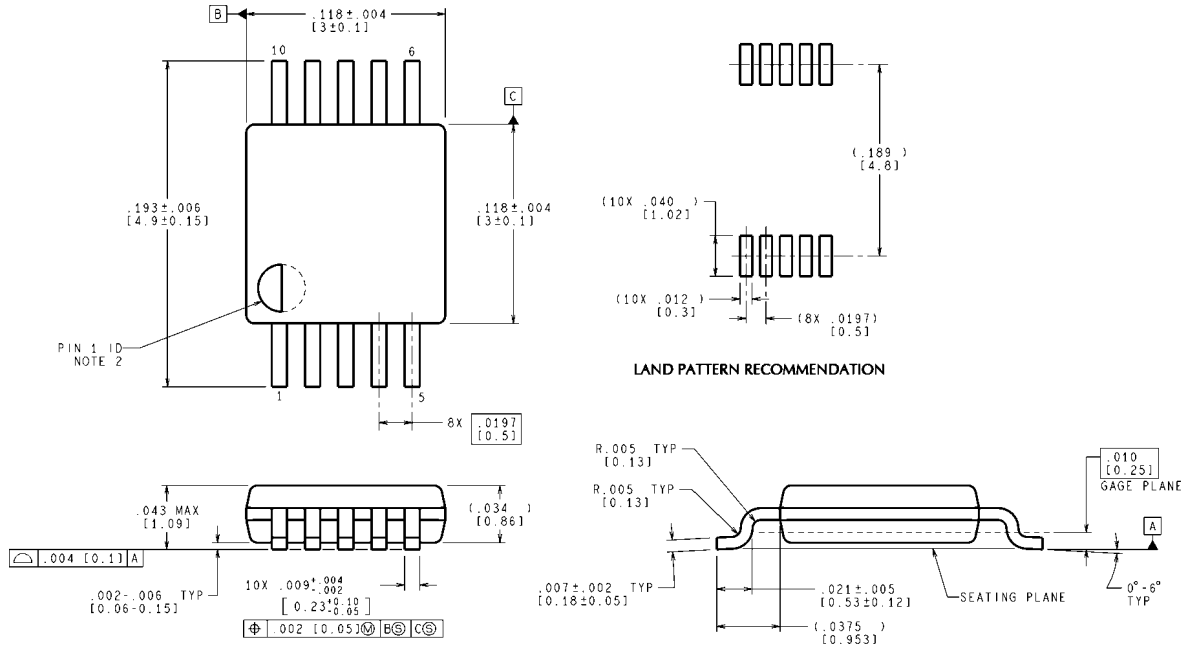

CONTROLLING DIMENSION IS INCH  
 VALUES IN [ ] ARE MILLIMETERS  
 DIMENSIONS IN ( ) FOR REFERENCE ONLY

**Mini SO Molded  
 NS Package MUB10A**

MUB10A (Rev B)

# Notes

LM34923

## Notes

For more National Semiconductor product information and proven design tools, visit the following Web sites at:  
[www.national.com](http://www.national.com)

Products		Design Support	
Amplifiers	<a href="http://www.national.com/amplifiers">www.national.com/amplifiers</a>	WEBENCH® Tools	<a href="http://www.national.com/webench">www.national.com/webench</a>
Audio	<a href="http://www.national.com/audio">www.national.com/audio</a>	App Notes	<a href="http://www.national.com/appnotes">www.national.com/appnotes</a>
Clock and Timing	<a href="http://www.national.com/timing">www.national.com/timing</a>	Reference Designs	<a href="http://www.national.com/refdesigns">www.national.com/refdesigns</a>
Data Converters	<a href="http://www.national.com/adc">www.national.com/adc</a>	Samples	<a href="http://www.national.com/samples">www.national.com/samples</a>
Interface	<a href="http://www.national.com/interface">www.national.com/interface</a>	Eval Boards	<a href="http://www.national.com/evalboards">www.national.com/evalboards</a>
LVDS	<a href="http://www.national.com/lvds">www.national.com/lvds</a>	Packaging	<a href="http://www.national.com/packaging">www.national.com/packaging</a>
Power Management	<a href="http://www.national.com/power">www.national.com/power</a>	Green Compliance	<a href="http://www.national.com/quality/green">www.national.com/quality/green</a>
Switching Regulators	<a href="http://www.national.com/switchers">www.national.com/switchers</a>	Distributors	<a href="http://www.national.com/contacts">www.national.com/contacts</a>
LDOs	<a href="http://www.national.com/ldo">www.national.com/ldo</a>	Quality and Reliability	<a href="http://www.national.com/quality">www.national.com/quality</a>
LED Lighting	<a href="http://www.national.com/led">www.national.com/led</a>	Feedback/Support	<a href="http://www.national.com/feedback">www.national.com/feedback</a>
Voltage References	<a href="http://www.national.com/vref">www.national.com/vref</a>	Design Made Easy	<a href="http://www.national.com/easy">www.national.com/easy</a>
PowerWise® Solutions	<a href="http://www.national.com/powerwise">www.national.com/powerwise</a>	Applications & Markets	<a href="http://www.national.com/solutions">www.national.com/solutions</a>
Serial Digital Interface (SDI)	<a href="http://www.national.com/sdi">www.national.com/sdi</a>	Mil/Aero	<a href="http://www.national.com/milaero">www.national.com/milaero</a>
Temperature Sensors	<a href="http://www.national.com/tempensors">www.national.com/tempensors</a>	SolarMagic™	<a href="http://www.national.com/solarmagic">www.national.com/solarmagic</a>
PLL/VCO	<a href="http://www.national.com/wireless">www.national.com/wireless</a>	PowerWise® Design University	<a href="http://www.national.com/training">www.national.com/training</a>

THE CONTENTS OF THIS DOCUMENT ARE PROVIDED IN CONNECTION WITH NATIONAL SEMICONDUCTOR CORPORATION ("NATIONAL") PRODUCTS. NATIONAL MAKES NO REPRESENTATIONS OR WARRANTIES WITH RESPECT TO THE ACCURACY OR COMPLETENESS OF THE CONTENTS OF THIS PUBLICATION AND RESERVES THE RIGHT TO MAKE CHANGES TO SPECIFICATIONS AND PRODUCT DESCRIPTIONS AT ANY TIME WITHOUT NOTICE. NO LICENSE, WHETHER EXPRESS, IMPLIED, ARISING BY ESTOPPEL OR OTHERWISE, TO ANY INTELLECTUAL PROPERTY RIGHTS IS GRANTED BY THIS DOCUMENT.

TESTING AND OTHER QUALITY CONTROLS ARE USED TO THE EXTENT NATIONAL DEEMS NECESSARY TO SUPPORT NATIONAL'S PRODUCT WARRANTY. EXCEPT WHERE MANDATED BY GOVERNMENT REQUIREMENTS, TESTING OF ALL PARAMETERS OF EACH PRODUCT IS NOT NECESSARILY PERFORMED. NATIONAL ASSUMES NO LIABILITY FOR APPLICATIONS ASSISTANCE OR BUYER PRODUCT DESIGN. BUYERS ARE RESPONSIBLE FOR THEIR PRODUCTS AND APPLICATIONS USING NATIONAL COMPONENTS. PRIOR TO USING OR DISTRIBUTING ANY PRODUCTS THAT INCLUDE NATIONAL COMPONENTS, BUYERS SHOULD PROVIDE ADEQUATE DESIGN, TESTING AND OPERATING SAFEGUARDS.

EXCEPT AS PROVIDED IN NATIONAL'S TERMS AND CONDITIONS OF SALE FOR SUCH PRODUCTS, NATIONAL ASSUMES NO LIABILITY WHATSOEVER, AND NATIONAL DISCLAIMS ANY EXPRESS OR IMPLIED WARRANTY RELATING TO THE SALE AND/OR USE OF NATIONAL PRODUCTS INCLUDING LIABILITY OR WARRANTIES RELATING TO FITNESS FOR A PARTICULAR PURPOSE, MERCHANTABILITY, OR INFRINGEMENT OF ANY PATENT, COPYRIGHT OR OTHER INTELLECTUAL PROPERTY RIGHT.

#### LIFE SUPPORT POLICY

**NATIONAL'S PRODUCTS ARE NOT AUTHORIZED FOR USE AS CRITICAL COMPONENTS IN LIFE SUPPORT DEVICES OR SYSTEMS WITHOUT THE EXPRESS PRIOR WRITTEN APPROVAL OF THE CHIEF EXECUTIVE OFFICER AND GENERAL COUNSEL OF NATIONAL SEMICONDUCTOR CORPORATION.** As used herein:

Life support devices or systems are devices which (a) are intended for surgical implant into the body, or (b) support or sustain life and whose failure to perform when properly used in accordance with instructions for use provided in the labeling can be reasonably expected to result in a significant injury to the user. A critical component is any component in a life support device or system whose failure to perform can be reasonably expected to cause the failure of the life support device or system or to affect its safety or effectiveness.

National Semiconductor and the National Semiconductor logo are registered trademarks of National Semiconductor Corporation. All other brand or product names may be trademarks or registered trademarks of their respective holders.

Copyright© 2010 National Semiconductor Corporation

For the most current product information visit us at [www.national.com](http://www.national.com)



**National Semiconductor Americas Technical Support Center**  
 Email: [support@nsc.com](mailto:support@nsc.com)  
 Tel: 1-800-272-9959

**National Semiconductor Europe Technical Support Center**  
 Email: [europe.support@nsc.com](mailto:europe.support@nsc.com)

**National Semiconductor Asia Pacific Technical Support Center**  
 Email: [ap.support@nsc.com](mailto:ap.support@nsc.com)

**National Semiconductor Japan Technical Support Center**  
 Email: [jpn.feedback@nsc.com](mailto:jpn.feedback@nsc.com)

## IMPORTANT NOTICE

Texas Instruments Incorporated and its subsidiaries (TI) reserve the right to make corrections, modifications, enhancements, improvements, and other changes to its products and services at any time and to discontinue any product or service without notice. Customers should obtain the latest relevant information before placing orders and should verify that such information is current and complete. All products are sold subject to TI's terms and conditions of sale supplied at the time of order acknowledgment.

TI warrants performance of its hardware products to the specifications applicable at the time of sale in accordance with TI's standard warranty. Testing and other quality control techniques are used to the extent TI deems necessary to support this warranty. Except where mandated by government requirements, testing of all parameters of each product is not necessarily performed.

TI assumes no liability for applications assistance or customer product design. Customers are responsible for their products and applications using TI components. To minimize the risks associated with customer products and applications, customers should provide adequate design and operating safeguards.

TI does not warrant or represent that any license, either express or implied, is granted under any TI patent right, copyright, mask work right, or other TI intellectual property right relating to any combination, machine, or process in which TI products or services are used. Information published by TI regarding third-party products or services does not constitute a license from TI to use such products or services or a warranty or endorsement thereof. Use of such information may require a license from a third party under the patents or other intellectual property of the third party, or a license from TI under the patents or other intellectual property of TI.

Reproduction of TI information in TI data books or data sheets is permissible only if reproduction is without alteration and is accompanied by all associated warranties, conditions, limitations, and notices. Reproduction of this information with alteration is an unfair and deceptive business practice. TI is not responsible or liable for such altered documentation. Information of third parties may be subject to additional restrictions.

Resale of TI products or services with statements different from or beyond the parameters stated by TI for that product or service voids all express and any implied warranties for the associated TI product or service and is an unfair and deceptive business practice. TI is not responsible or liable for any such statements.

TI products are not authorized for use in safety-critical applications (such as life support) where a failure of the TI product would reasonably be expected to cause severe personal injury or death, unless officers of the parties have executed an agreement specifically governing such use. Buyers represent that they have all necessary expertise in the safety and regulatory ramifications of their applications, and acknowledge and agree that they are solely responsible for all legal, regulatory and safety-related requirements concerning their products and any use of TI products in such safety-critical applications, notwithstanding any applications-related information or support that may be provided by TI. Further, Buyers must fully indemnify TI and its representatives against any damages arising out of the use of TI products in such safety-critical applications.

TI products are neither designed nor intended for use in military/aerospace applications or environments unless the TI products are specifically designated by TI as military-grade or "enhanced plastic." Only products designated by TI as military-grade meet military specifications. Buyers acknowledge and agree that any such use of TI products which TI has not designated as military-grade is solely at the Buyer's risk, and that they are solely responsible for compliance with all legal and regulatory requirements in connection with such use.

TI products are neither designed nor intended for use in automotive applications or environments unless the specific TI products are designated by TI as compliant with ISO/TS 16949 requirements. Buyers acknowledge and agree that, if they use any non-designated products in automotive applications, TI will not be responsible for any failure to meet such requirements.

Following are URLs where you can obtain information on other Texas Instruments products and application solutions:

### Products

Audio	<a href="http://www.ti.com/audio">www.ti.com/audio</a>
Amplifiers	<a href="http://amplifier.ti.com">amplifier.ti.com</a>
Data Converters	<a href="http://dataconverter.ti.com">dataconverter.ti.com</a>
DLP® Products	<a href="http://www.dlp.com">www.dlp.com</a>
DSP	<a href="http://dsp.ti.com">dsp.ti.com</a>
Clocks and Timers	<a href="http://www.ti.com/clocks">www.ti.com/clocks</a>
Interface	<a href="http://interface.ti.com">interface.ti.com</a>
Logic	<a href="http://logic.ti.com">logic.ti.com</a>
Power Mgmt	<a href="http://power.ti.com">power.ti.com</a>
Microcontrollers	<a href="http://microcontroller.ti.com">microcontroller.ti.com</a>
RFID	<a href="http://www.ti-rfid.com">www.ti-rfid.com</a>
OMAP Mobile Processors	<a href="http://www.ti.com/omap">www.ti.com/omap</a>
Wireless Connectivity	<a href="http://www.ti.com/wirelessconnectivity">www.ti.com/wirelessconnectivity</a>

### Applications

Communications and Telecom	<a href="http://www.ti.com/communications">www.ti.com/communications</a>
Computers and Peripherals	<a href="http://www.ti.com/computers">www.ti.com/computers</a>
Consumer Electronics	<a href="http://www.ti.com/consumer-apps">www.ti.com/consumer-apps</a>
Energy and Lighting	<a href="http://www.ti.com/energy">www.ti.com/energy</a>
Industrial	<a href="http://www.ti.com/industrial">www.ti.com/industrial</a>
Medical	<a href="http://www.ti.com/medical">www.ti.com/medical</a>
Security	<a href="http://www.ti.com/security">www.ti.com/security</a>
Space, Avionics and Defense	<a href="http://www.ti.com/space-avionics-defense">www.ti.com/space-avionics-defense</a>
Transportation and Automotive	<a href="http://www.ti.com/automotive">www.ti.com/automotive</a>
Video and Imaging	<a href="http://www.ti.com/video">www.ti.com/video</a>

TI E2E Community Home Page

[e2e.ti.com](http://e2e.ti.com)

Mailing Address: Texas Instruments, Post Office Box 655303, Dallas, Texas 75265  
Copyright © 2011, Texas Instruments Incorporated