

IRLML2803

HEXFET® Power MOSFET

- Generation V Technology
- Ultra Low On-Resistance
- N-Channel MOSFET
- SOT-23 Footprint
- Low Profile (<1.1mm)
- Available in Tape and Reel
- Fast Switching

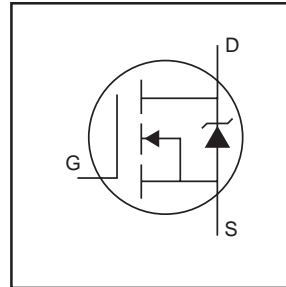

$$V_{DSS} = 30V$$

$$R_{DS(on)} = 0.25\Omega$$

Description

Fifth Generation HEXFETs from International Rectifier utilize advanced processing techniques to achieve extremely low on-resistance per silicon area. This benefit, combined with the fast switching speed and ruggedized device design that HEXFET Power MOSFETs are well known for, provides the designer with an extremely efficient and reliable device for use in a wide variety of applications.

A customized leadframe has been incorporated into the standard SOT-23 package to produce a HEXFET Power MOSFET with the industry's smallest footprint. This package, dubbed the Micro3, is ideal for applications where printed circuit board space is at a premium. The low profile (<1.1mm) of the Micro3 allows it to fit easily into extremely thin application environments such as portable electronics and PCMCIA cards.

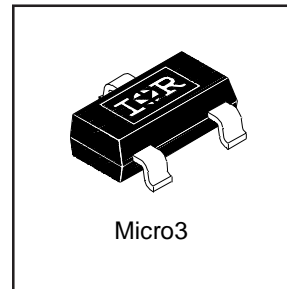

Micro3

Absolute Maximum Ratings

	Parameter	Max.	Units
$I_D @ T_A = 25^\circ C$	Continuous Drain Current, $V_{GS} @ 10V$	1.2	A
$I_D @ T_A = 70^\circ C$	Continuous Drain Current, $V_{GS} @ 10V$	0.93	
I_{DM}	Pulsed Drain Current ①	7.3	
$P_D @ T_A = 25^\circ C$	Power Dissipation	540	mW
	Linear Derating Factor	4.3	mW/°C
V_{GS}	Gate-to-Source Voltage	± 20	V
dv/dt	Peak Diode Recovery dv/dt ②	5.0	V/ns
T_J, T_{STG}	Junction and Storage Temperature Range	-55 to + 150	°C

Thermal Resistance

	Parameter	Typ.	Max.	Units
$R_{\theta JA}$	Maximum Junction-to-Ambient ④	—	230	°C/W

IRLML2803

International
IR Rectifier

Electrical Characteristics @ $T_J = 25^\circ\text{C}$ (unless otherwise specified)

	Parameter	Min.	Typ.	Max.	Units	Conditions
$V_{(BR)DSS}$	Drain-to-Source Breakdown Voltage	30	—	—	V	$V_{GS} = 0V, I_D = 250\mu A$
$\Delta V_{(BR)DSS}/\Delta T_J$	Breakdown Voltage Temp. Coefficient	—	0.029	—	V/ $^\circ\text{C}$	Reference to $25^\circ\text{C}, I_D = 1\text{mA}$
$R_{DS(on)}$	Static Drain-to-Source On-Resistance	—	—	0.25	Ω	$V_{GS} = 10V, I_D = 0.91A$ ③
		—	—	0.40		$V_{GS} = 4.5V, I_D = 0.46A$ ③
$V_{GS(th)}$	Gate Threshold Voltage	1.0	—	—	V	$V_{DS} = V_{GS}, I_D = 250\mu A$
g_{fs}	Forward Transconductance	0.87	—	—	S	$V_{DS} = 10V, I_D = 0.46A$
I_{DSS}	Drain-to-Source Leakage Current	—	—	1.0	μA	$V_{DS} = 24V, V_{GS} = 0V$
		—	—	25		$V_{DS} = 24V, V_{GS} = 0V, T_J = 125^\circ\text{C}$
I_{GSS}	Gate-to-Source Forward Leakage	—	—	-100	nA	$V_{GS} = -20V$
	Gate-to-Source Reverse Leakage	—	—	100		$V_{GS} = 20V$
Q_g	Total Gate Charge	—	3.3	5.0	nC	$I_D = 0.91A$
Q_{gs}	Gate-to-Source Charge	—	0.48	0.72		$V_{DS} = 24V$
Q_{gd}	Gate-to-Drain ("Miller") Charge	—	1.1	1.7		$V_{GS} = 10V$, See Fig. 6 and 9 ③
$t_{d(on)}$	Turn-On Delay Time	—	3.9	—		$V_{DD} = 15V$
t_r	Rise Time	—	4.0	—	ns	$I_D = 0.91A$
$t_{d(off)}$	Turn-Off Delay Time	—	9.0	—		$R_G = 6.2\Omega$
t_f	Fall Time	—	1.7	—		$R_D = 16\Omega$, See Fig. 10 ③
C_{iss}	Input Capacitance	—	85	—	pF	$V_{GS} = 0V$
C_{oss}	Output Capacitance	—	34	—		$V_{DS} = 25V$
C_{rss}	Reverse Transfer Capacitance	—	15	—		$f = 1.0\text{MHz}$, See Fig. 5

Source-Drain Ratings and Characteristics

	Parameter	Min.	Typ.	Max.	Units	Conditions
I_S	Continuous Source Current (Body Diode)	—	—	0.54	A	MOSFET symbol showing the integral reverse p-n junction diode.
I_{SM}	Pulsed Source Current (Body Diode) ①	—	—	7.3		
V_{SD}	Diode Forward Voltage	—	—	1.2	V	$T_J = 25^\circ\text{C}, I_S = 0.91A, V_{GS} = 0V$ ③
t_{rr}	Reverse Recovery Time	—	26	40	ns	$T_J = 25^\circ\text{C}, I_F = 0.91A$
Q_{rr}	Reverse Recovery Charge	—	22	32	nC	$di/dt = 100A/\mu s$ ③

Notes:

- ① Repetitive rating; pulse width limited by max. junction temperature. (See fig. 11)
- ② $I_{SD} \leq 0.91A, di/dt \leq 120A/\mu s, V_{DD} \leq V_{(BR)DSS}, T_J \leq 150^\circ\text{C}$
- ③ Pulse width $\leq 300\mu s$; duty cycle $\leq 2\%$.
- ④ Surface mounted on FR-4 board, $t \leq 5\text{sec}$.

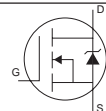

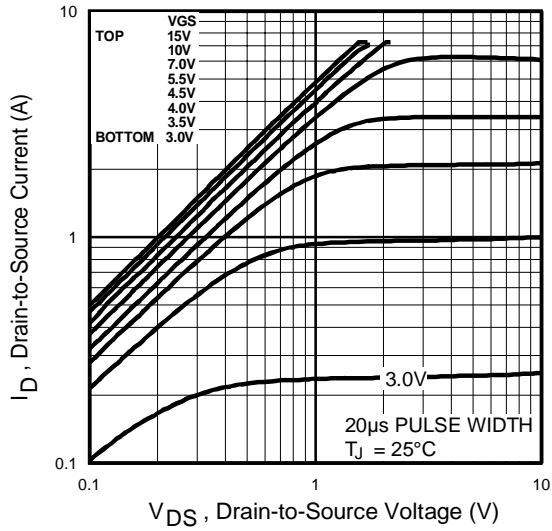

Fig 1. Typical Output Characteristics

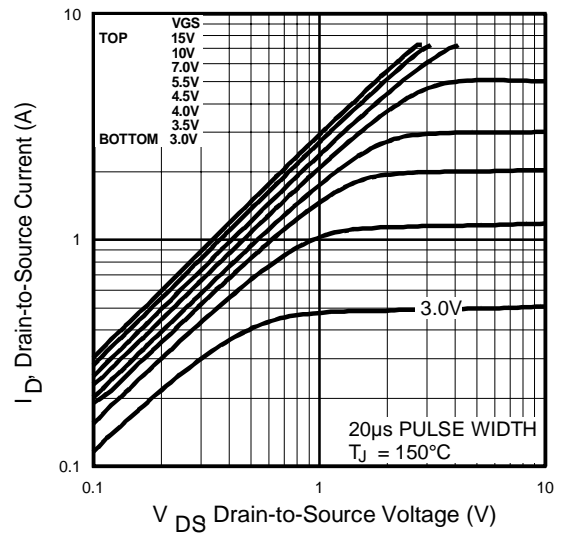

Fig 2. Typical Output Characteristics

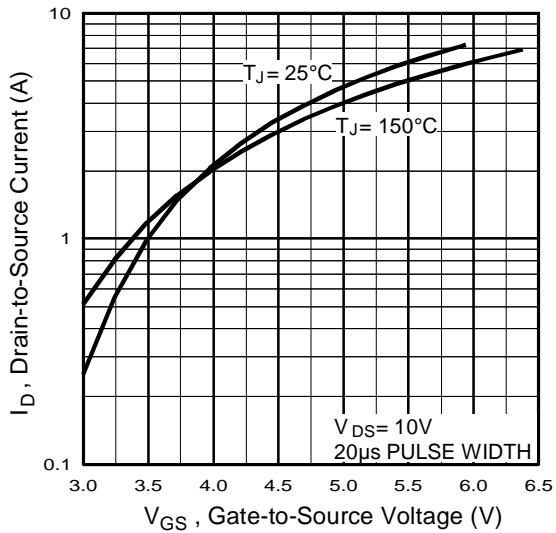

Fig 3. Typical Transfer Characteristics

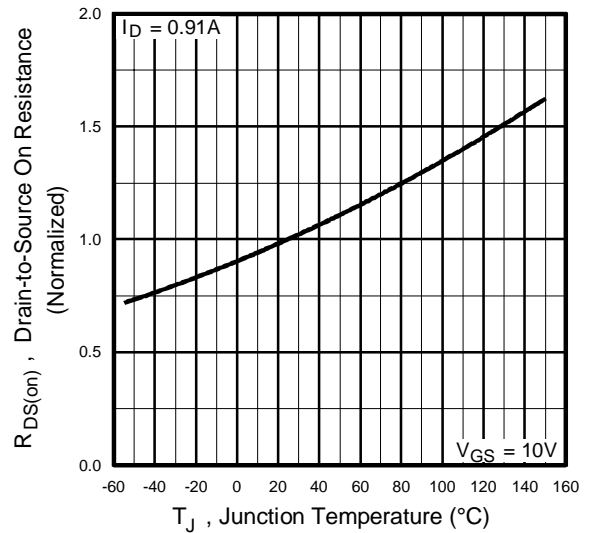

Fig 4. Normalized On-Resistance Vs. Temperature

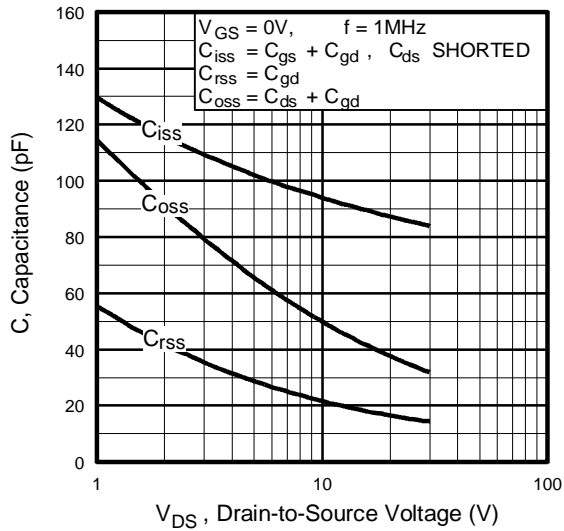

Fig 5. Typical Capacitance Vs. Drain-to-Source Voltage

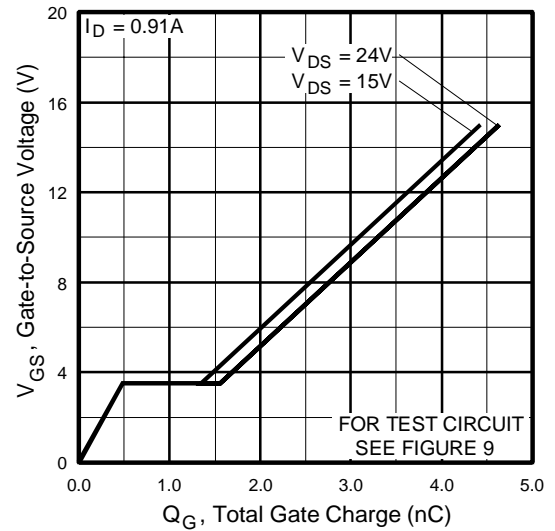

Fig 6. Typical Gate Charge Vs. Gate-to-Source Voltage

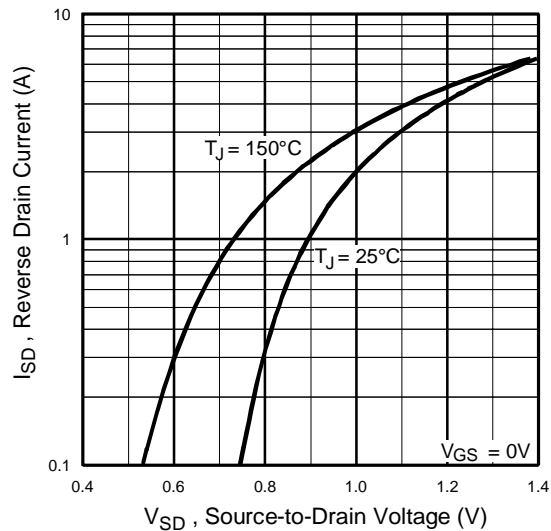

Fig 7. Typical Source-Drain Diode Forward Voltage

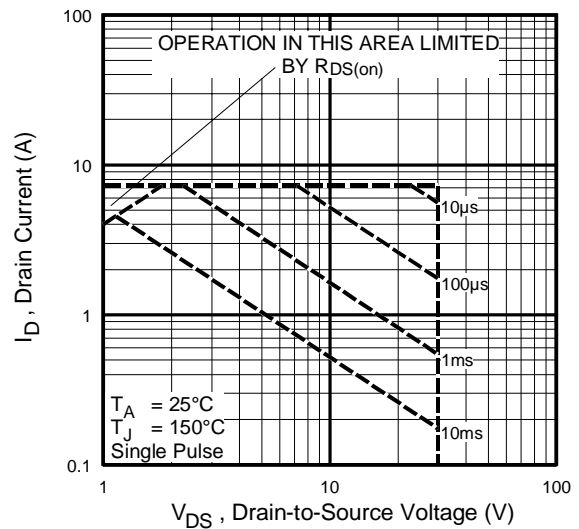

Fig 8. Maximum Safe Operating Area

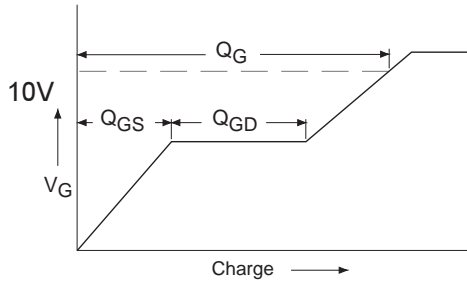

Fig 9a. Basic Gate Charge Waveform

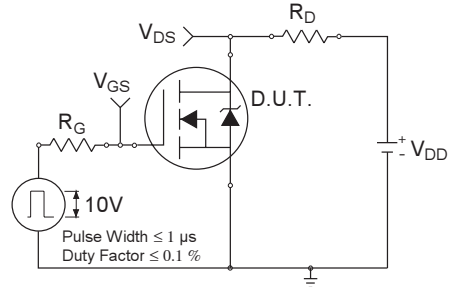

Fig 10a. Switching Time Test Circuit

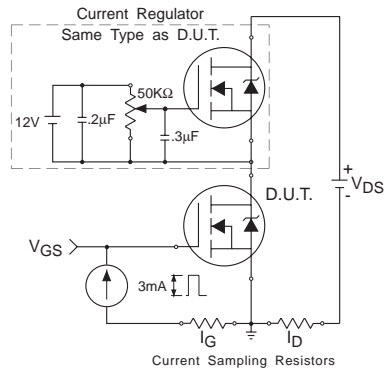

Fig 9b. Gate Charge Test Circuit

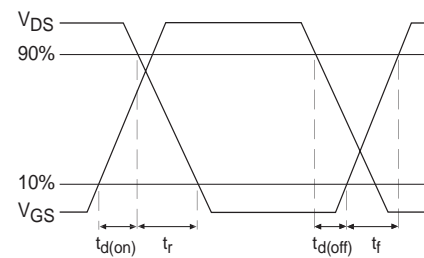

Fig 10b. Switching Time Waveforms

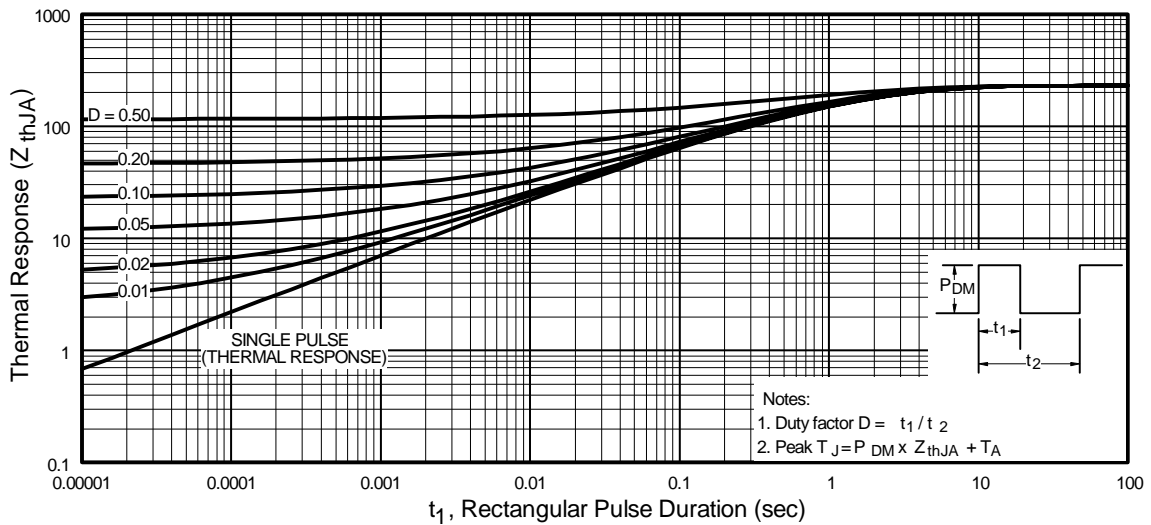

Fig 11. Maximum Effective Transient Thermal Impedance, Junction-to-Ambient

Peak Diode Recovery dv/dt Test Circuit

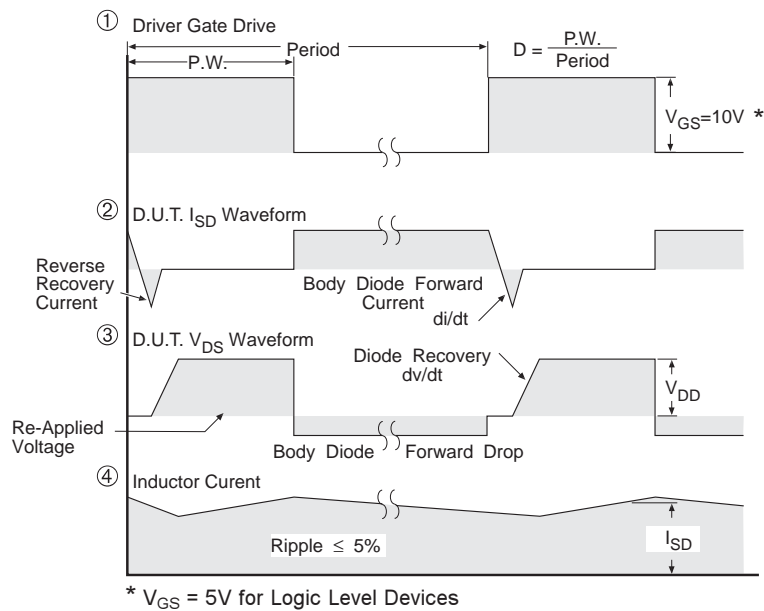
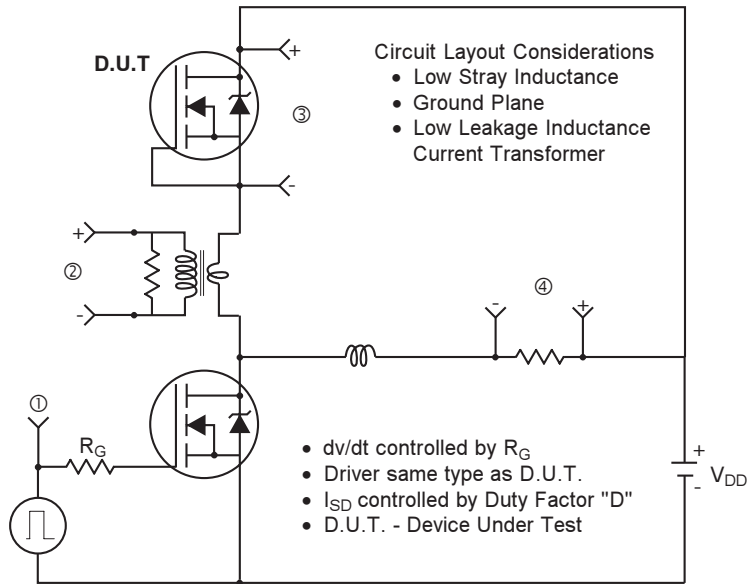
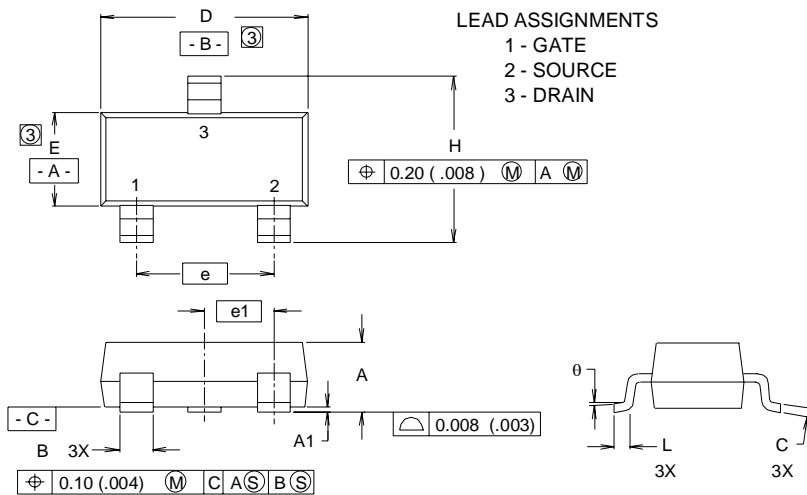

Fig 12. For N-Channel HEXFETS

Package Outline

SOT-23 Outline

Dimensions are shown in millimeters (inches)



DIM	INCHES		MILLIMETERS	
	MIN	MAX	MIN	MAX
A	.032	.044	0.82	1.11
A1	.001	.004	0.02	0.10
B	.015	.021	0.38	0.54
C	.004	.006	0.10	0.15
D	.105	.120	2.67	3.05
e	.0750 BASIC		1.90 BASIC	
e1	.0375 BASIC		0.95 BASIC	
E	.047	.055	1.20	1.40
H	.083	.098	2.10	2.50
L	.005	.010	0.13	0.25
θ	0°	8°	0°	8°

MINIMUM RECOMMENDED FOOTPRINT

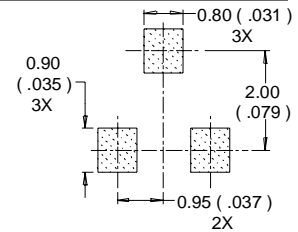

NOTES:

1. DIMENSIONING & TOLERANCING PER ANSI Y14.5M-1982.
2. CONTROLLING DIMENSION : INCH.
3. DIMENSIONS DO NOT INCLUDE MOLD FLASH.

IRLML2803

Part Marking Information SOT-23

International
IR Rectifier

Notes: This part marking information applies to devices produced before 02/26/2001

EXAMPLE: THIS IS AN IRLML6302

WW = (1-26) IF PRECEDED BY LAST DIGIT OF CALENDAR YEAR

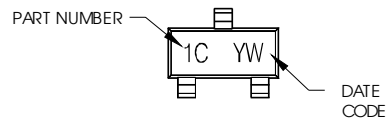

PART NUMBER CODE REFERENCE:

1A = IRLML2402
1B = IRLML2803
1C = IRLML6302
1D = IRLML5103
1E = IRLML6402
1F = IRLML6401
1G = IRLML2502
1H = IRLML5203

DATE CODE EXAMPLES:

YWW = 9503 = 5C
YWW = 9532 = EF

YEAR	Y	WORK WEEK	W
2001	1	01	A
2002	2	02	B
2003	3	03	C
1994	4	04	D
1995	5		
1996	6		
1997	7		
1998	8		
1999	9		
2000	0	24	X
		25	Y
		26	Z

WW = (27-52) IF PRECEDED BY A LETTER

YEAR	Y	WORK WEEK	W
2001	A	27	A
2002	B	28	B
2003	C	29	C
1994	D	30	D
1995	E		
1996	F		
1997	G		
1998	H		
1999	J		
2000	K	50	X
		51	Y
		52	Z

Notes: This part marking information applies to devices produced after 02/26/2001

W = (1-26) IF PRECEDED BY LAST DIGIT OF CALENDAR YEAR

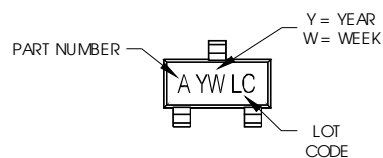

PART NUMBER CODE REFERENCE:

A = IRLML2402
B = IRLML2803
C = IRLML6302
D = IRLML5103
E = IRLML6402
F = IRLML6401
G = IRLML2502
H = IRLML5203

YEAR	Y	WORK WEEK	W
2001	1	01	A
2002	2	02	B
2003	3	03	C
1994	4	04	D
1995	5		
1996	6		
1997	7		
1998	8		
1999	9		
2000	0	24	X
		25	Y
		26	Z

W = (27-52) IF PRECEDED BY A LETTER

YEAR	Y	WORK WEEK	W
2001	A	27	A
2002	B	28	B
2003	C	29	C
1994	D	30	D
1995	E		
1996	F		
1997	G		
1998	H		
1999	J		
2000	K	50	X
		51	Y
		52	Z

Tape & Reel Information

SOT-23

Dimensions are shown in millimeters (inches)

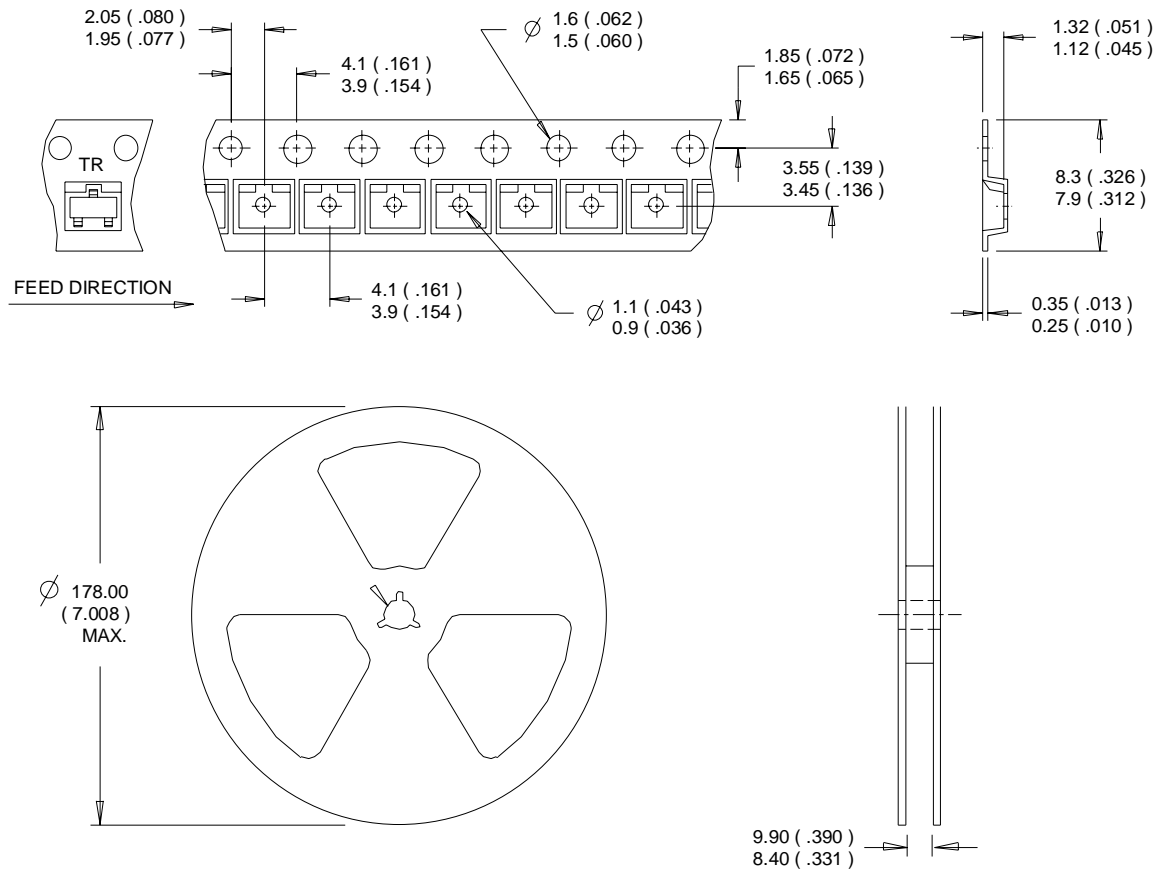

NOTES:

1. CONTROLLING DIMENSION : MILLIMETER.
2. OUTLINE CONFORMS TO EIA-481 & EIA-541.

Data and specifications subject to change without notice.