



Product Description

The Sirenza Microdevices' STQ-2016 is a direct quadrature modulator targeted for use in a wide range of communications systems, including cellular/PCS, CDMA2000, UMTS, and ISM datacom. This device features a wide 700-2500 MHz operating frequency band, excellent carrier and sideband suppression, and a low broadband noise floor.

The STQ-2016 uses silicon germanium (SiGe) device technology and delivers a typical output power of -11dBm with greater than 60dB IM3 suppression. A digital input shut-down feature is included that, when enabled, attenuates the output by 60dB. The device is packaged in an industry standard 16 pin TSSOP with exposed paddle for superb RF and thermal ground. The STQ-2016Z is packaged in a RoHS compliant and Green 16-pin TSSOP with matte tin finish.

Functional Block Diagram

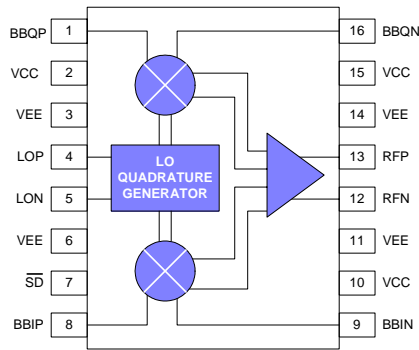

Product Specifications – RF Output: $T_A = 25^\circ\text{C}$

Parameters	Test Conditions (see page 2)	Units	Min.	Typ.	Max.	Min.	Typ.	Max.
RF Frequency Range		MHz	700		1000	1700		2500
Output Power	baseband 200kHz @ 600mVp-p differential	dBm	-13.0	-10.5	-9.0	-15.0	-11.5	-9.0
RF Port Return Loss	matched to 50Ω (refer to schematics on pages 6 & 7)	dB		20			16	
Output P1dB	(I/Q inputs = 3.74 Vp-p differential typical)	dBm	+3	+4		0	+3	
Carrier Feedthrough		dBm		-40	-34		-40	-32
Sideband Suppression		dB	34	40		34	40	
IM3 Suppression	two-tone baseband input @ 600mVp-p differential per tone	dB	58	62		58	65	
Broadband Noise Floor	baseband inputs tied to 1.9V _{DC} , -20MHz offset from carrier	dBm/Hz		-154	-152		-155	-153
Quadrature Phase Error		deg	-2	±0.5	+2	-2	±0.5	+2
I/Q Amplitude Balance		dB	-0.2	±0.05	+0.2	-0.2	±0.05	+0.2
Supply Voltage (Vcc)		V	+4.75	+5	+5.25	+4.75	+5	+5.25
Supply Current		mA		73	86		73	86
Device Thermal Resistance	junction-case	°C/W		25			25	

The information provided herein is believed to be reliable at press time. Sirenza Microdevices assumes no responsibility for inaccuracies or omissions. Sirenza Microdevices assumes no responsibility for the use of this information, and all such information shall be entirely at the user's own risk. Prices and specifications are subject to change without notice. No patent rights or licenses to any of the circuits described herein are implied or granted to any third party. Sirenza Microdevices does not authorize or warrant any Sirenza Microdevices product for use in life-support devices and/or systems.

Copyright 2001 Sirenza Microdevices, Inc. All worldwide rights reserved.
303 South Technology Court Broomfield, CO 80021

Phone: (800) SMI-MMIC

1

<http://www.sirenza.com>
EDS-102083 Rev F

STQ-2016

STQ-2016Z



700-2500 MHz Direct Quadrature Modulator

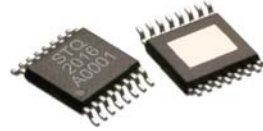

16 pin TSSOP with Exposed Ground Pad

Package Footprint: 0.197 x 0.252 inches, (5.0 x 6.4 mm)
Package Height: 0.039 inches (1.0 mm)

Product Features

- Excellent carrier feedthrough, -40 dBm constant with output power
- Output P1dB +3dBm
- Wide baseband input, DC - 500 MHz
- Superb phase accuracy and amplitude balance, ±0.5 deg./±0.2 dB
- Very low noise floor, -155 dBm/Hz
- Low LO drive requirement, -5 dBm

Applications

- Cellular/PCS/CDMA2000/UMTS transceivers
- ISM band transceivers, 900 & 2400 MHz
- GMSK, QPSK, QAM, SSB modulators

Test Conditions

(for all product specification tables unless otherwise noted)

V _{CC} (pins 2,10,15)	+5V
T _A	+25°C
Baseband Input (Pins 1, 8, 9, 16)	1.9V DC bias, 200kHz frequency, 300mVp-p per pin = 600mVp-p differential drive, I and Q signals in quadrature
LO Input (Pins 4, 5)	-5dBm @ 1960 MHz

Product Specifications - Baseband Modulation Input: T_A = 25°C

Parameters	Additional Test Conditions	Unit	Min.	Typ.	Max.
Baseband Frequency Input	-3dB bandwidth, baseband inputs terminated in 50 ohms	MHz	DC		500
Baseband Input Resistance	per pin	kohms		4.4	
Baseband Input Capacitance	per pin	pF		0.5	

Product Specifications - LO Input: T_A = 25°C

Parameters	Additional Test Conditions	Unit	Min.	Typ.	Max.
LO Frequency		MHz	700		2500
LO Drive Level		dBm	-8	-5	-2
LO Port Return Loss	matched to 50Ω (refer to schematics on pages 6 & 7)	dB		16	

Product Specifications – Miscellaneous: T_A = 25°C

Parameters	Additional Test Conditions	Unit	Min.	Typ.	Max.
Shut-Down Attenuation		dB		60	
Shut-Down Pin Resistance	@ 1MHz	kohm		11.9	
Shut-Down Pin Capacitance	@ 1MHz	pF		5.2	
Shut-down Control Voltage Thresholds	Shut-down disabled (normal operation)	V	3.75		V _{CC}
	Shut-down enabled	V	0.0		1.5
Shut-Down Settling Time		ns		<450	

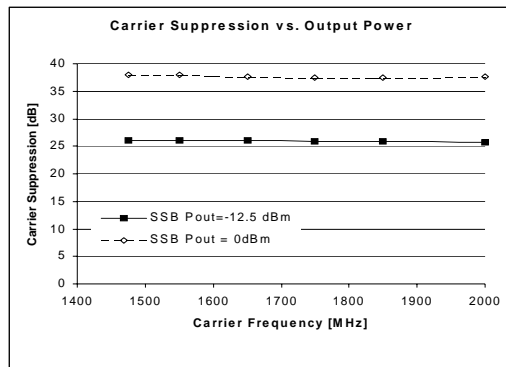

700 - 1000 MHz Typical Device Performance

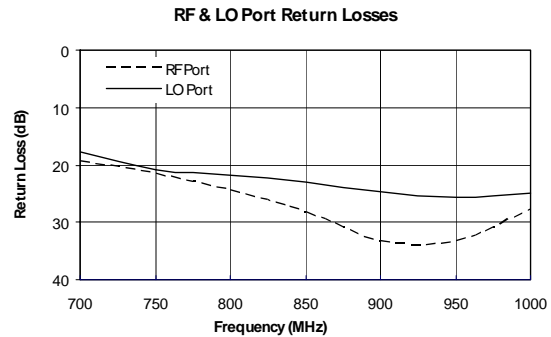
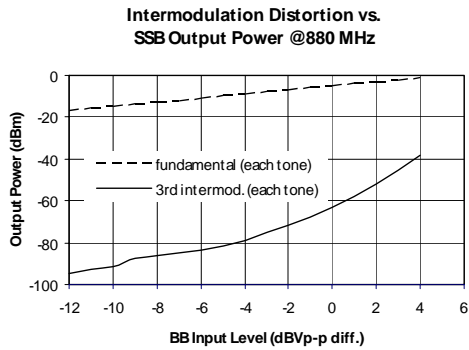
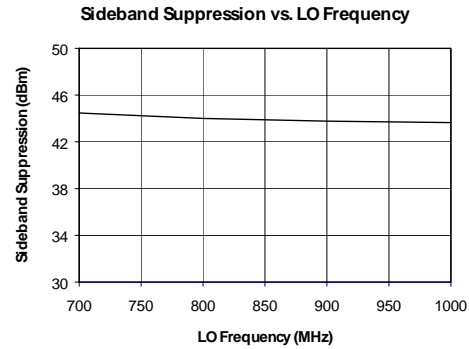
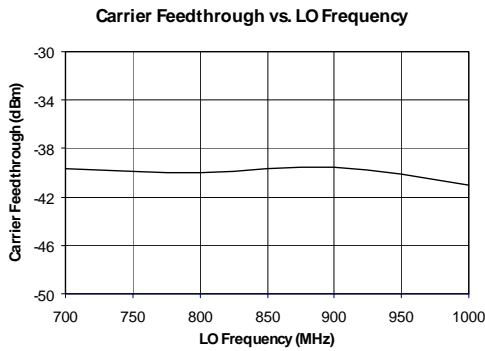
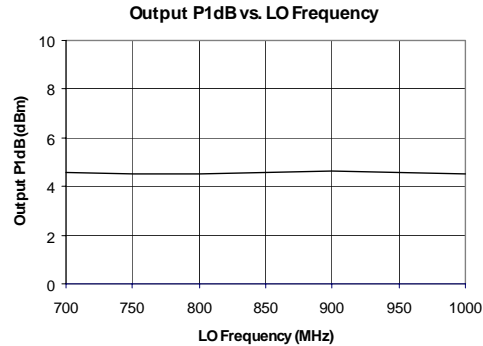
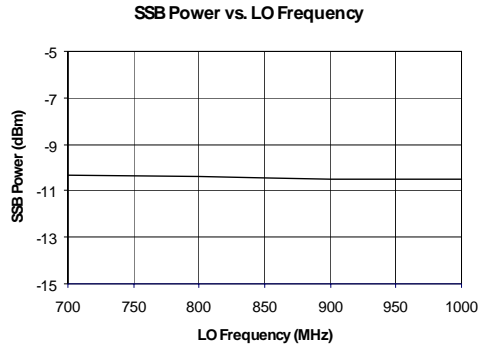

1500 - 2500 MHz Typical Device Performance

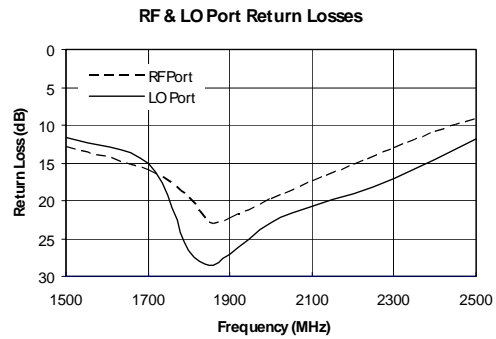
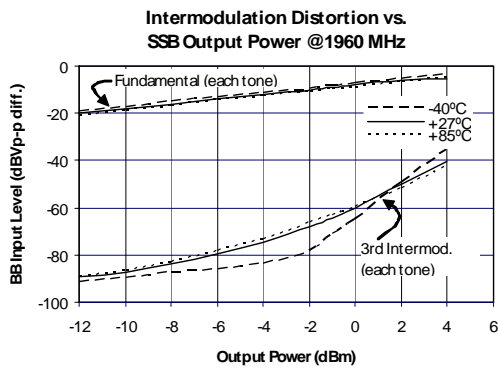
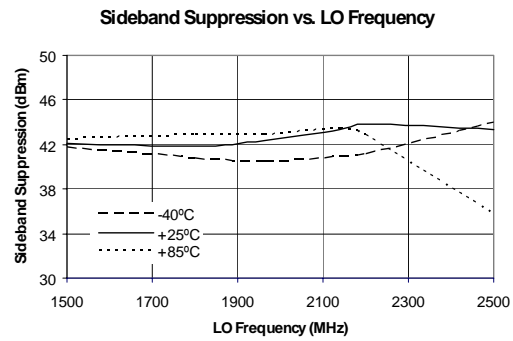
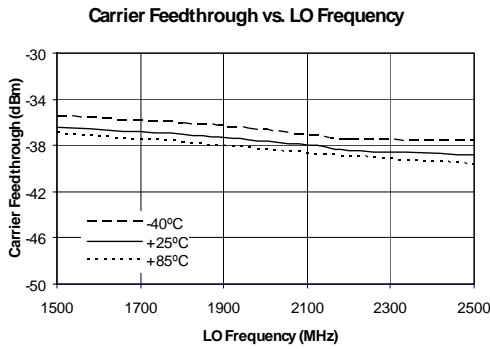
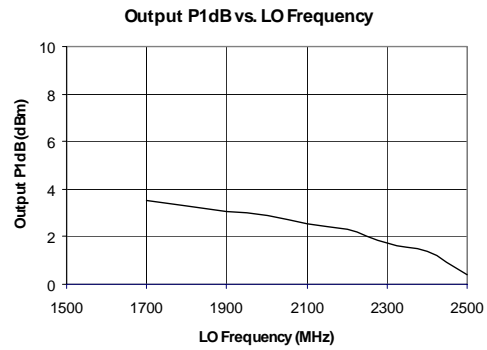
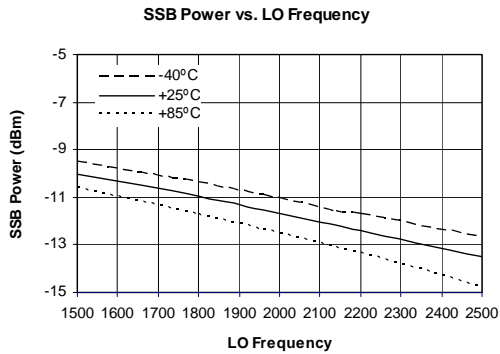

Package Dimensions ("16" Package)

Dimensions in inches (mm)

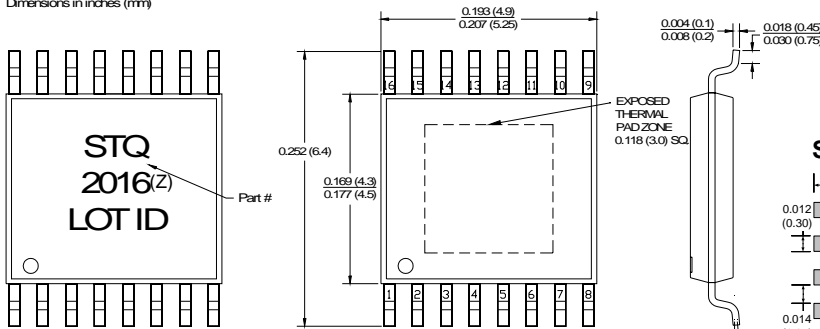

NOTES:

1. PACKAGE BODY SIZES EXCLUDE MOLD FLASH PROTRUSIONS OR GATE BURRS.
2. TOLERANCE ± 0.1 MM UNLESS OTHERWISE SPECIFIED.
3. COPLANARITY: 0.1MM
4. CONTROLLING DIMENSION IS MILLIMETER. CONVERTED INCH DIMENSIONS ARE NOT NECESSARILY EXACT.
5. FOLLOWED FROM JEDEC MO-153.

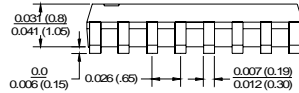

Suggested PCB Pad Layout

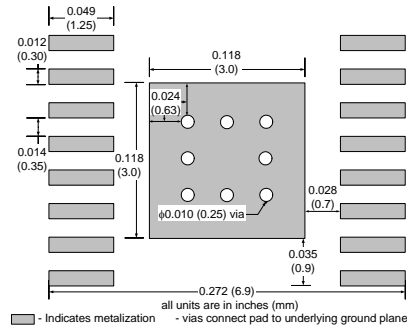

Pin Out Description

Pin #	Function	Description	Additional Comments
1	BBQP	Q-channel baseband input, positive terminal	Nominal DC bias voltage is 1.9V (biased internally)
2	VCC	Positive supply (+5V)	
3	VEE	Ground	
4	LOP	Local oscillator input, positive terminal	Nominal DC voltage is 2.0V. Input should be AC-coupled.
5	LON	Local oscillator input, negative terminal	Nominal DC voltage is 2.0V. Input should be AC-coupled.
6	VEE	Ground	
7	SD	Shut-down control	Logic high = normal operation; logic low = shut-down enabled.
8	BBIP	I-channel baseband input, positive terminal	Nominal DC bias voltage is 1.9V (biased internally)
9	BBIN	I-channel baseband input, negative terminal	Nominal DC bias voltage is 1.9V (biased internally)
10	VCC	Positive supply (+5V)	
11	VEE	Ground	
12	RFN	RF output, negative terminal	Nominal DC voltage is 2.4V. Output should be AC-coupled.
13	RFP	RF output, positive terminal	Nominal DC voltage is 2.4V. Output should be AC-coupled.
14	VEE	Ground	
15	VCC	Positive supply (+5V)	
16	BBQN	Q-channel baseband input, negative terminal	Nominal DC bias voltage is 1.9V (biased internally)

Absolute Maximum Ratings

Parameters	Value	Unit
Supply Voltage (VCC)	6.0	V _{DC}
LO, RF Input (LOP, LON, RFP, RFN)	+10	dBm
Baseband Min Input Voltage (BBIP, BBIN, BBQP, BBQN)	0	V _{DC}
Baseband Max Input Voltage (BBIP, BBIN, BBQP, BBQN)	3	V _{DC}
Operating Temperature	-40 to +85	°C
Storage Temperature	-65 to +150	°C

Operation of this device beyond any one of these limits may cause permanent damage. For reliable continuous operation the device voltage and current must not exceed the maximum operating values specified in the table on page one.

Part Number Ordering Information

Part Number	Reel Size	Devices/Reel
STQ-2016	7"	1000
STQ-2016Z	7"	1000



Caution: ESD Sensitive

Appropriate precaution in handling, packaging and testing devices must be observed.

700 – 1000 MHz Application Schematic

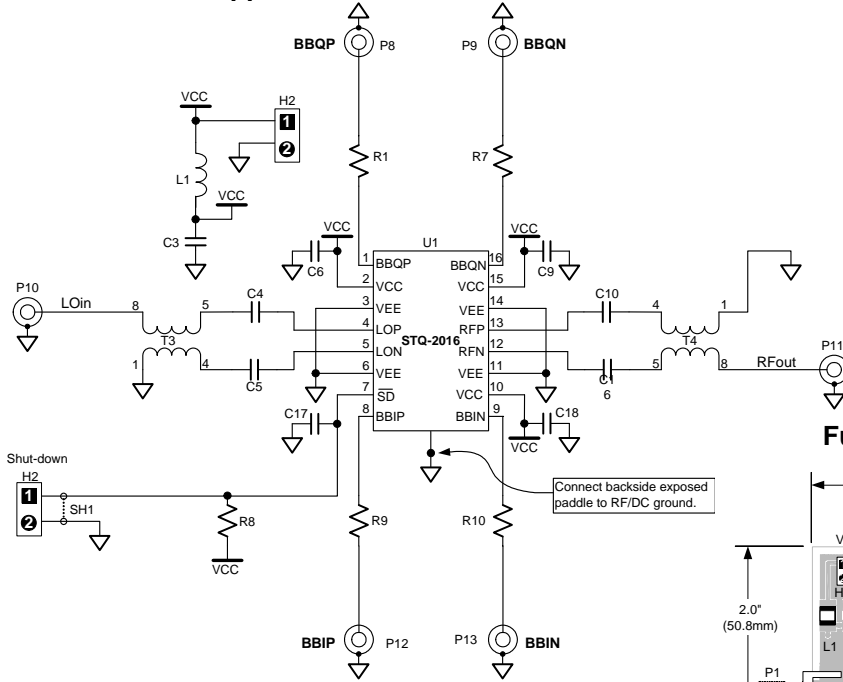

Fully Assembled PCB

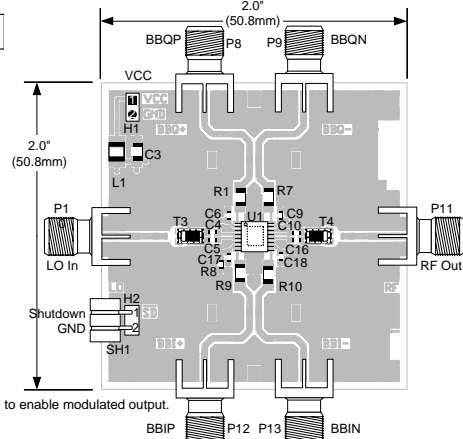

Bill of Materials (for 700 – 1000 MHz Evaluation Board P/N STQ-2016EVB-1)

Component Designator	Value	Qty	Vendor	Part Number	Description
U1		1	SMDI	STQ-2016	SiGe Direct Quadrature Modulator
P8, P9, P10, P11, P12, P13		6	Johnson Components	142-0701-851	SMA connector, end launch with tab, for .062" thick board
H1, H2		2	AMP	640453-2	2-pin header, right angle
T3, T4	1:1	2	Panasonic	EHF-FD1618	RF transformer, 700-1300MHz
L1	1uH	1	Panasonic	ELJ-FA1R0KF2	Inductor, 1210 footprint, ±10% tolerance
R1, R7, R9, R10	200 ohm	4	Venkel	CR1206-8W-2000T	Resistor, 1206 footprint, ±1% tolerance
R8	1 kohm	1	Venkel	CR0603-16W-1001FT	Resistor, 0603 footprint, ±1% tolerance
C6, C18	33pF	2	Venkel	C0603COG500-330JNE	Capacitor, 0603 footprint, COG dielectric, ±5% tolerance
C9, C17	1nF	2	Venkel	C0603COG500-102JNE	Capacitor, 0603 footprint, COG dielectric, ±5% tolerance
C3	2.2uF	1	Venkel	C1206Y5V160-225ZNE	Capacitor, 1206 footprint, Y5V dielectric, 16V rating
C4, C5, C10, C16	10pF	4	Venkel	C0603COG500-100JNE	Capacitor, 0603 footprint, COG dielectric, ±5% tolerance
SH1		1	3M	929950-00	Shunt for 2-pin header

1.7 – 2.5 GHz Application Schematic

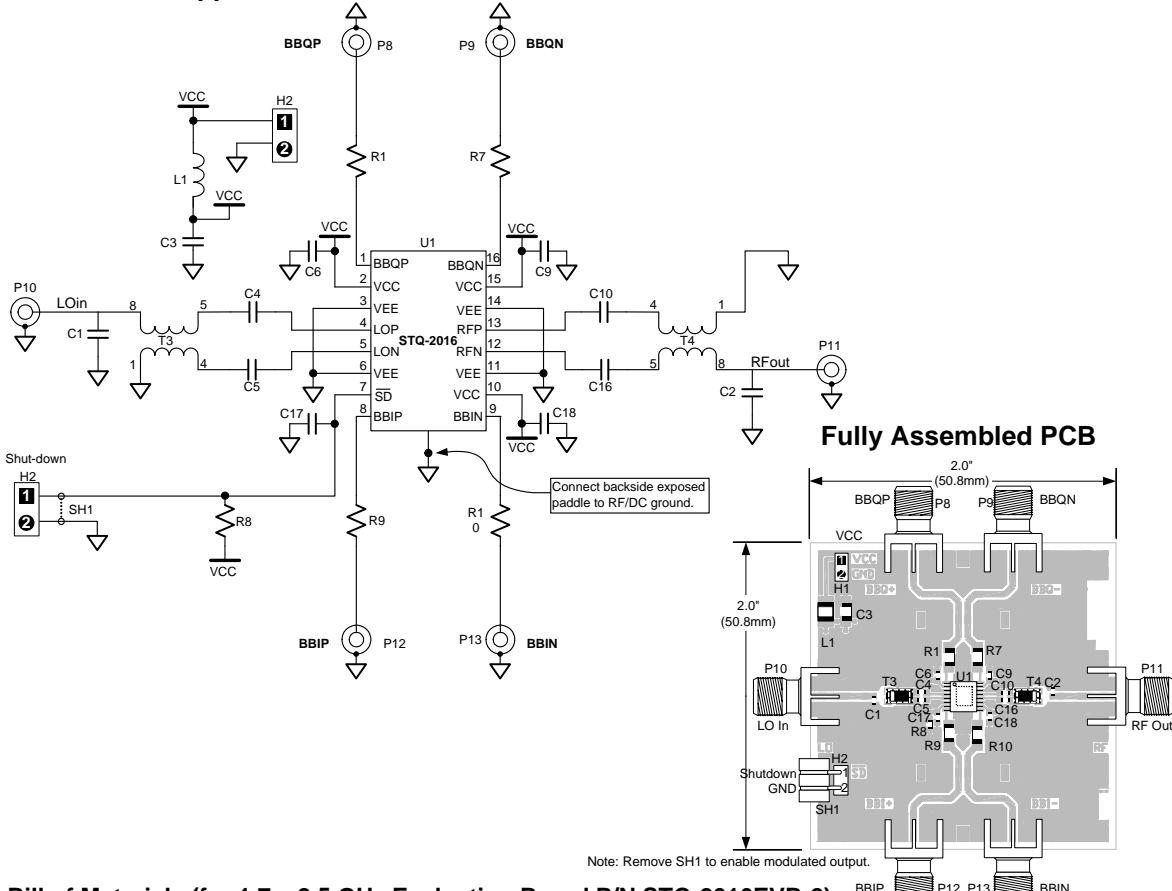

Bill of Materials (for 1.7 – 2.5 GHz Evaluation Board P/N STQ-2016EVB-2)

Component Designator	Value	Qty	Vendor	Part Number	Description
U1		1	SMDI	STQ-2016	SiGe Direct Quadrature Modulator
P8, P9, P10, P11, P12, P13		6	Johnson Components	142-0701-851	SMA connector, end launch with tab, for .062" thick board
H1, H2		2	AMP	640453-2	2-pin header, right angle
T3, T4	1:1	2	Panasonic	EHF-FD1619	RF transformer, 1200-2200MHz
L1	1uH	1	Panasonic	ELJ-FA1R0KF2	Inductor, 1210 footprint, ±10% tolerance
R1, R7, R9, R10	200 ohm	4	Venkel	CR1206-8W-2000T	Resistor, 1206 footprint, ±1% tolerance
R8	1 kohm	1	Venkel	CR0603-16W-1001FT	Resistor, 0603 footprint, ±1% tolerance
C1, C2	0.5pF	2	Venkel	C0603COG500-0R5CNE	Capacitor, 0603 footprint ±0.25pF tolerance
C6, C18	6.8pF	2	Venkel	C0603COG500-6R8CNE	Capacitor, 0603 footprint, COG dielectric, ±0.25pF tol.
C9, C17	1nF	2	Venkel	C0603COG500-102JNE	Capacitor, 0603 footprint, COG dielectric, ±5% tolerance
C3	2.2uF	1	Venkel	C1206Y5V160-225ZNE	Capacitor, 1206 footprint, Y5V dielectric, 16V rating
C4, C5, C10, C16	2.2pF	4	Venkel	C0603COG500-2R2CNE	Capacitor, 0603 footprint, COG dielectric, ±0.25pF tolerance
SH1		1	3M	929950-00	Shunt for 2-pin header

Direct Quadrature Modulator: General Test Set-Up

