

# Agilent HCPL-817 Phototransistor Optocoupler High Density Mounting Type Data Sheet

## Description

The HCPL-817 contains a light emitting diode optically coupled to a phototransistor. It is packaged in a 4-pin DIP package and available in wide-lead spacing option and lead bend SMD option. Input-output isolation voltage is 5000 Vrms. Response time,  $t_r$ , is typically 4  $\mu$ s and minimum CTR is 50% at input current of 5 mA.

## Functional Diagram

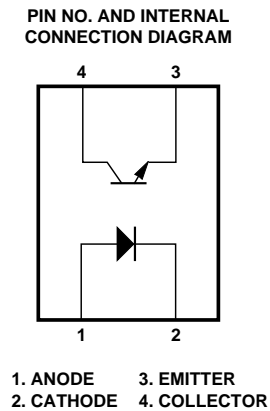

## Ordering Information

Specify part number followed by Option Number (if desired).

HCPL-817-XXXXE  
 └───┬─── Lead Free  
 └───┴─── Option Number

- 000 = No Options
- 060 = IEC/EN/DIN EN 60747-5-2 Option
- W00 = 0.4" Lead Spacing Option
- 300 = Lead Bend SMD Option
- 500 = Tape and Reel Packaging Option
- 00A = Rank Mark A
- 00B = Rank Mark B
- 00C = Rank Mark C
- 00D = Rank Mark D
- 00L = Rank Mark L

## Schematic

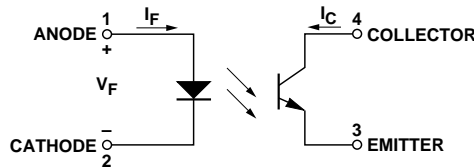

## Features

- **Current Transfer Ratio**  
(CTR: min. 50% at  $I_F = 5$  mA,  $V_{CE} = 5$  V)
- **High input-output isolation voltage**  
( $V_{iso} = 5000$  Vrms)
- **Response time** ( $t_r$ : typ., 4  $\mu$ s at  $V_{CE} = 2$  V,  $I_C = 2$  mA,  $R_L = 100 \Omega$ )
- **Compact dual-in-line package**
- **UL approved**
- **CSA approved**
- **IEC/EN/DIN EN 60747-5-2 approved**
- **Options available:**
  - Leads with 0.4" (10.16 mm) spacing (W00)
  - Leads bends for surface mounting (300)
  - Tape and reel for SMD (500)
  - IEC/EN/DIN EN 60747-5-2 approvals (060)

## Applications

- **Signal transmission between circuits of different potentials and impedances**
- **I/O interfaces for computers**
- **Feedback circuit in power supply**

**CAUTION:** It is advised that normal static precautions be taken in handling and assembly of this component to prevent damage and/or degradation which may be induced by ESD.

**Package Outline Drawings**  
**HCPL-817-000E**

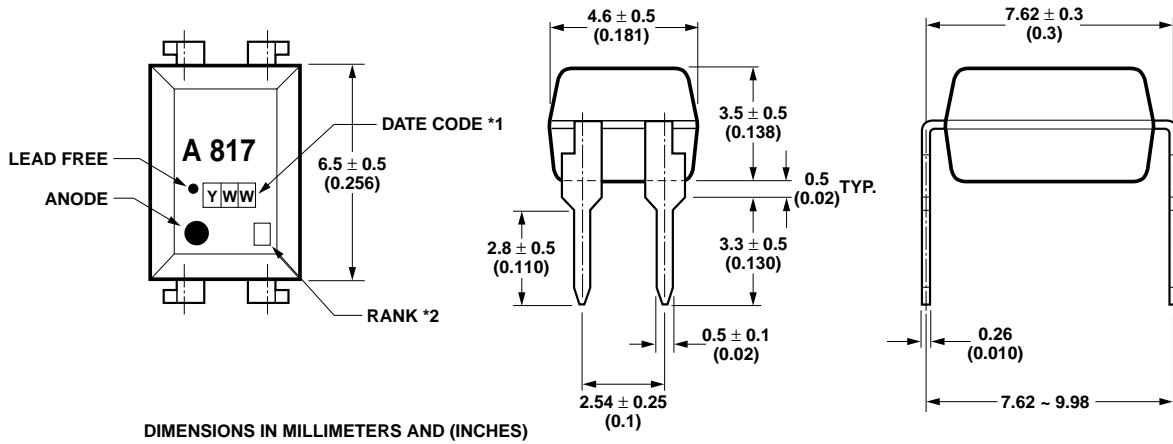

**HCPL-817-060E**

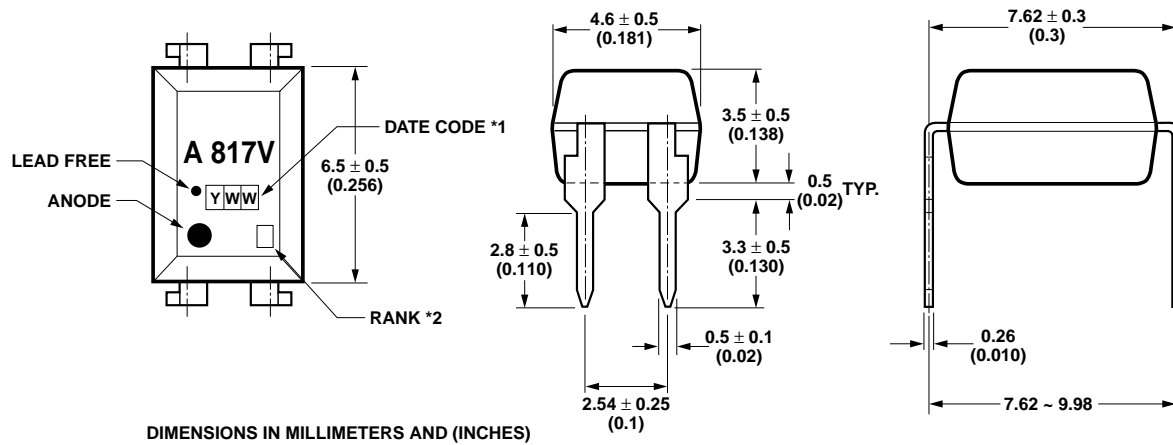

**HCPL-817-W00E**

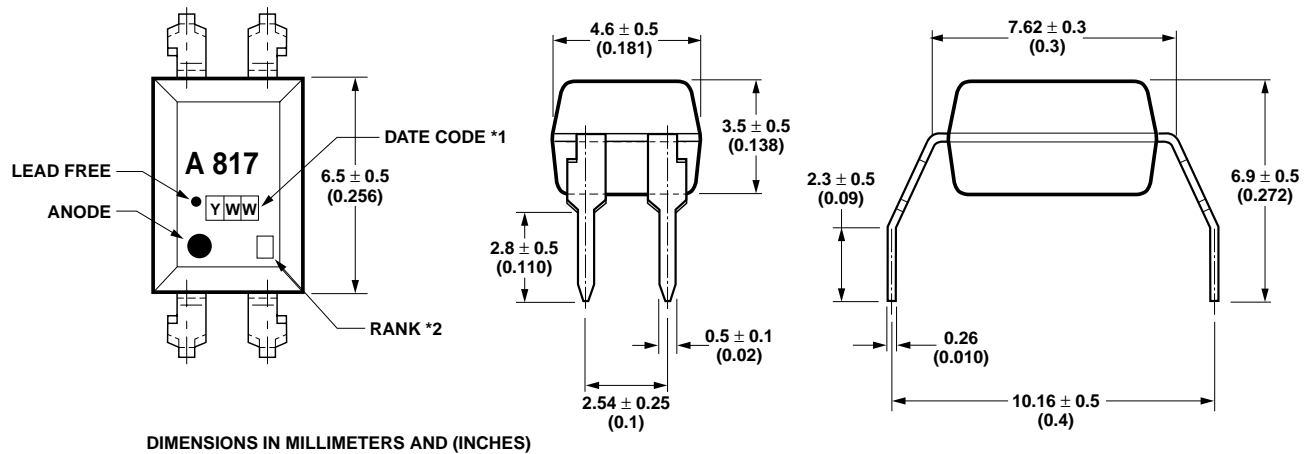

**HCPL-817-300E**

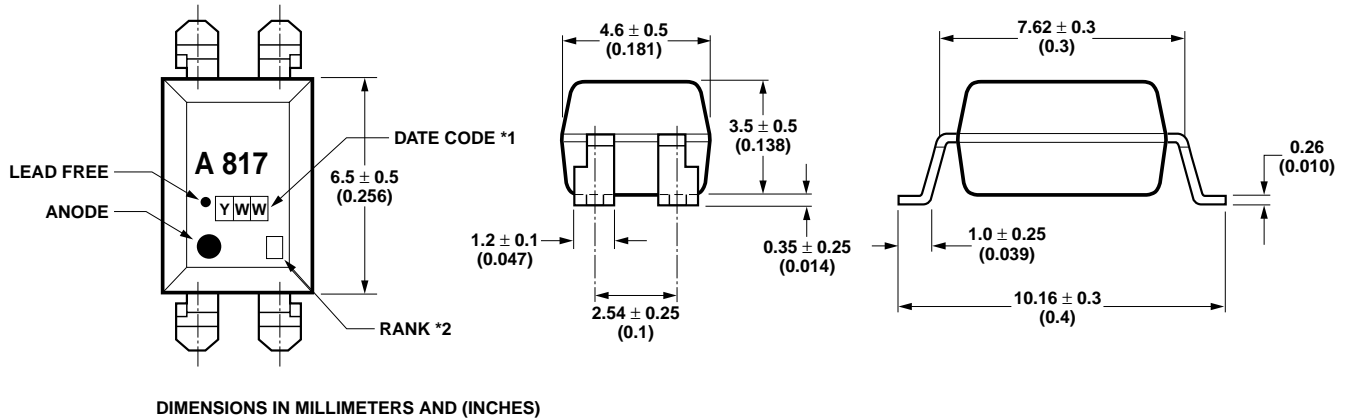

**Solder Reflow Temperature Profile**

- 1) One-time soldering reflow is recommended within the condition of temperature and time profile shown at right.
- 2) When using another soldering method such as infrared ray lamp, the temperature may rise partially in the mold of the device. Keep the temperature on the package of the device within the condition of (1) above.

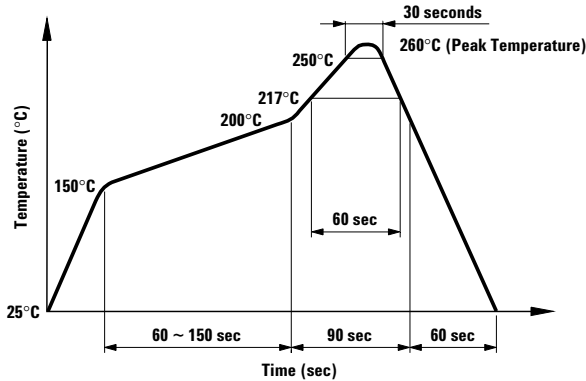

**Absolute Maximum Ratings (T<sub>A</sub> = 25°C)**

Storage Temperature, T <sub>S</sub>	-55°C to +125°C
Operating Temperature, T <sub>A</sub>	-30°C to +100°C
Lead Solder Temperature, max. (1.6 mm below seating plane)	260°C for 10 s
Average Forward Current, I <sub>F</sub>	50 mA
Reverse Input Voltage, V <sub>R</sub>	6 V
Input Power Dissipation, P <sub>I</sub>	70 mW
Collector Current, I <sub>C</sub>	50 mA
Collector-Emitter Voltage, V <sub>CE0</sub>	35 V
Emitter-Collector Voltage, V <sub>ECO</sub>	6 V
Collector Power Dissipation	150 mW
Total Power Dissipation	200 mW
Isolation Voltage, V <sub>iso</sub> (AC for 1 minute, R.H. = 40 ~ 60%)	5000 Vrms

### Electrical Specifications (T<sub>A</sub> = 25 °C)

Parameter	Symbol	Min.	Typ.	Max.	Units	Test Conditions
Forward Voltage	V <sub>F</sub>	–	1.2	1.4	V	I <sub>F</sub> = 20 mA
Reverse Current	I <sub>R</sub>	–	–	10	μA	V <sub>R</sub> = 4 V
Terminal Capacitance	C <sub>t</sub>	–	30	250	pF	V = 0, f = 1 KHz
Collector Dark Current	I <sub>CEO</sub>	–	–	100	nA	V <sub>CE</sub> = 20 V
Collector-Emitter Breakdown Voltage	BV <sub>CEO</sub>	35	–	–	V	I <sub>C</sub> = 0.1 mA
Emitter-Collector Breakdown Voltage	BV <sub>ECO</sub>	6	–	–	V	I <sub>E</sub> = 10 μA
Collector Current	I <sub>C</sub>	2.5	–	30	mA	I <sub>F</sub> = 5 mA, V <sub>CE</sub> = 5 V,
*Current Transfer Ratio	CTR	50	–	600	%	R <sub>BE</sub> = ∞
Collector-Emitter Saturation Voltage	V <sub>CE(sat)</sub>	–	0.1	0.2	V	I <sub>F</sub> = 20 mA, I <sub>C</sub> = 1 mA
Response Time (Rise)	t <sub>r</sub>	–	4	18	μs	V <sub>CC</sub> = 2 V, I <sub>C</sub> = 2 mA
Response Time (Fall)	t <sub>f</sub>	–	3	18	μs	R <sub>L</sub> = 100 Ω
Cut-off Frequency	f <sub>c</sub>	–	80	–	KHz	V <sub>CC</sub> = 5 V, I <sub>C</sub> = 2 mA R <sub>L</sub> = 100 Ω, –3 dB
Isolation Resistance	R <sub>iso</sub>	5 × 10 <sup>10</sup>	1 × 10 <sup>11</sup>	–	Ω	DC 500 V 40 ~ 60% R.H.
Floating Capacitance	C <sub>f</sub>	–	0.6	1.0	pF	V = 0, f = 1 MHz

$$* \text{CTR} = \frac{I_C}{I_F} \times 100\%$$

Rank Mark	CTR (%)	Conditions
L	50 ~ 100	I <sub>F</sub> = 5 mA, V <sub>CE</sub> = 5 V, T <sub>A</sub> = 25 °C
A	80 ~ 160	
B	130 ~ 260	
C	200 ~ 400	
D	300 ~ 600	

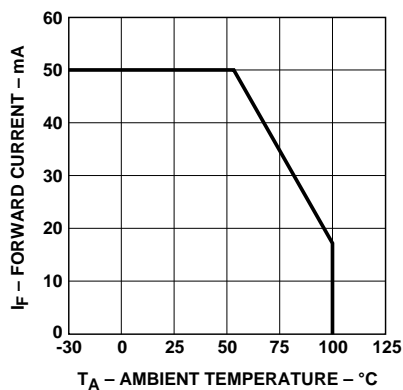

Figure 1. Forward current vs. temperature.

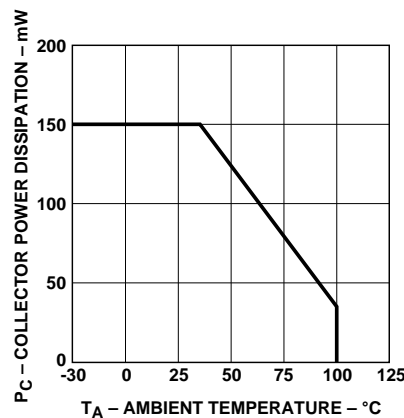

Figure 2. Collector power dissipation vs. temperature.

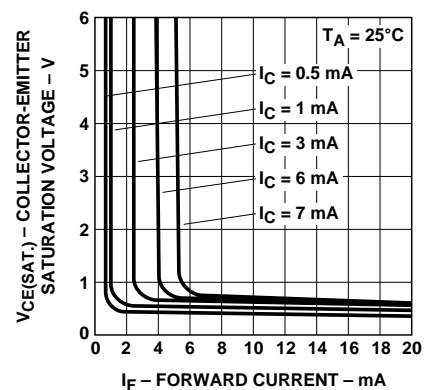

Figure 3. Collector-emitter saturation voltage vs. forward current.

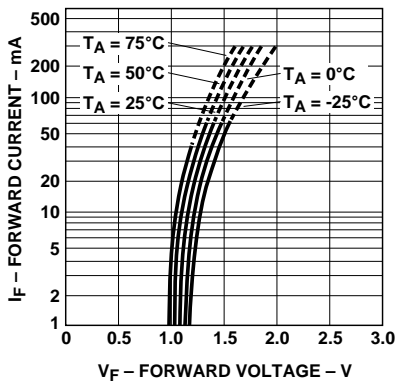

Figure 4. Forward current vs. forward voltage.

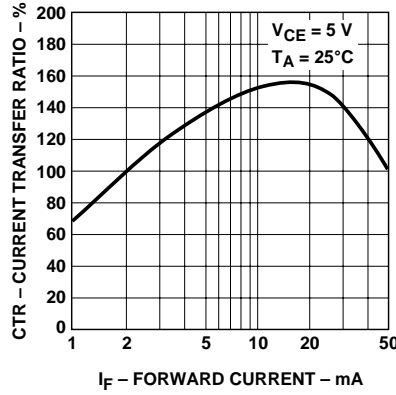

Figure 5. Current transfer ratio vs. forward current.

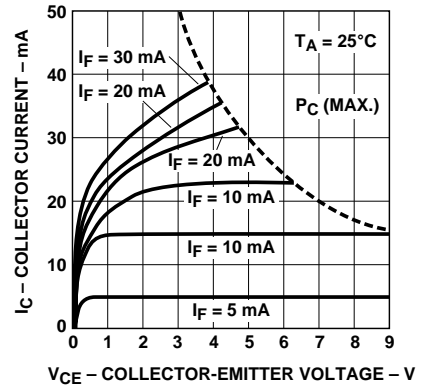

Figure 6. Collector current vs. collector-emitter voltage.

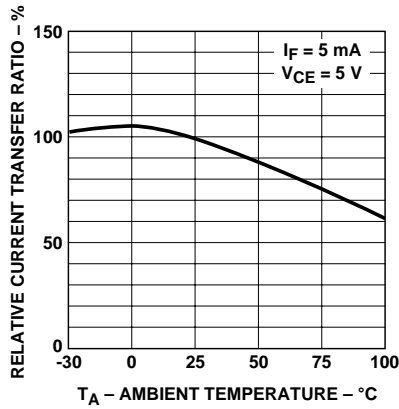

Figure 7. Relative current transfer ratio vs. temperature.

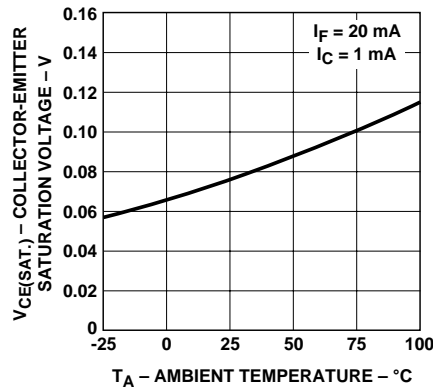

Figure 8. Collector-emitter saturation voltage vs. temperature.

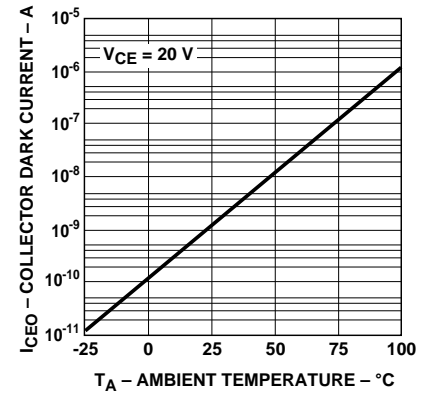

Figure 9. Collector dark current vs. temperature.

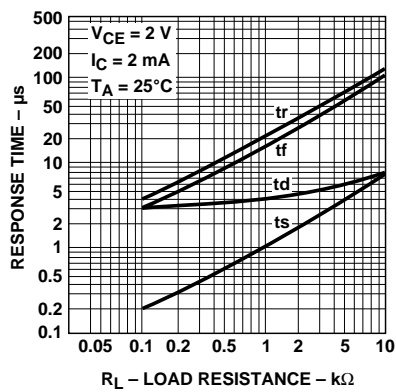

Figure 10. Response time vs. load resistance.

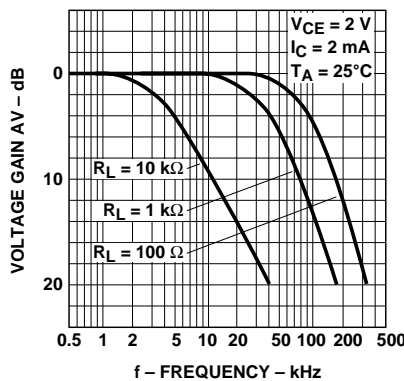
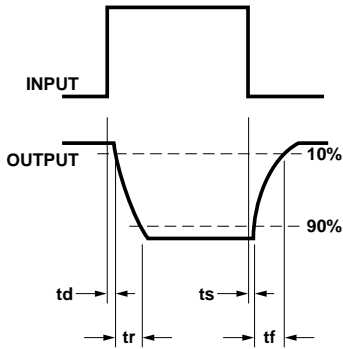
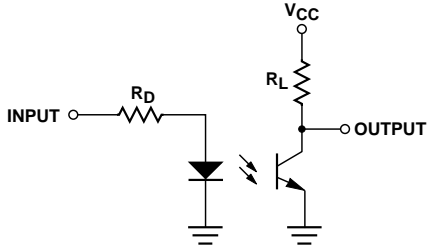
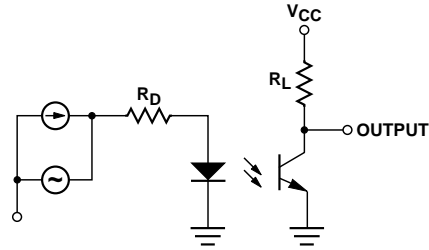

Figure 11. Frequency response.

### Test Circuit for Response Time



### Test Circuit for Frequency Response



### [www.agilent.com/semiconductors](http://www.agilent.com/semiconductors)

For product information and a complete list of distributors, please go to our web site.

For technical assistance call:

Americas/Canada: +1 (800) 235-0312 or (916) 788-6763

Europe: +49 (0) 6441 92460

China: 10800 650 0017

Hong Kong: (+65) 6756 2394

India, Australia, New Zealand: (+65) 6755 1939

Japan: (+81 3) 3335-8152 (Domestic/International), or 0120-61-1280 (Domestic Only)

Korea: (+65) 6755 1989

Singapore, Malaysia, Vietnam, Thailand, Philippines, Indonesia: (+65) 6755 2044

Taiwan: (+65) 6755 1843

Data subject to change.

Copyright © 2004 Agilent Technologies, Inc.

Obsoletes 5989-0293EN

October 27, 2004

5989-1734EN



**Agilent Technologies**