

General Description

The MIC5325 is a high performance, μ Cap low dropout regulator, offering ultra-low operating current while maintaining very fast transient response. The MIC5325 can source up to 400mA of output current and allows a low input supply voltage source to increase system efficiency.

Ideal for battery operated applications; the MIC5325 offers high accuracy, extremely low dropout voltage, and low ground current at all load conditions. The MIC5325 can also be put into a zero-off-mode current state, drawing virtually no current when disabled.

The MIC5325 is available in fixed output voltages in the 6-pin 2mm x 2mm Thin MLF® leadless package.

Data sheets and support documentation can be found on Micrel's web site at www.micrel.com.

Features

- Wide input voltage range: 1.7V to 5.5V
- Stable with 1 μ F ceramic output capacitor
- Ultra-low dropout voltage ULDO™ 110mV @ 400mA
- $\pm 2\%$ voltage accuracy over temperature
- Bias supply voltage range: 2.5V to 5.5V
- Adjustable output voltage range: 0.8V to 2.0V
- Ultra-low ground current 35 μ A typical
- 400mA maximum output current per LDO
- Very fast transient response
- Thermal shutdown and current limit protection
- Tiny 6-pin 2mm x 2mm Thin MLF® package

Applications

- Low power handheld devices
- Portable electronics
- GPS receivers
- Post regulator

Typical Application

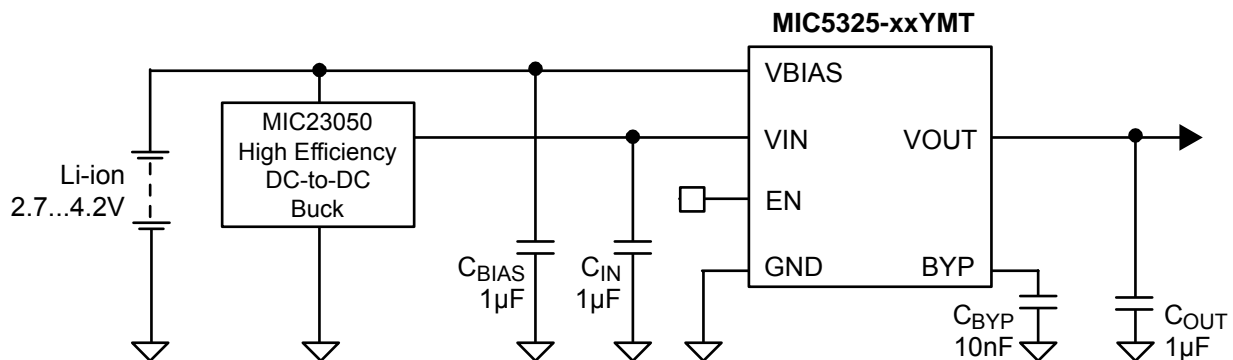

ULDO is a trademark of Micrel, Inc
MLF and *MicroLeadFrame* are registered trademarks of Amkor Technology, Inc.

Micrel Inc. • 2180 Fortune Drive • San Jose, CA 95131 • USA • tel +1 (408) 944-0800 • fax + 1 (408) 474-1000 • <http://www.micrel.com>

Ordering Information

Part Number	Marking	Voltage	Temperature Range	Package	Lead Finish
MIC5325-1.2YMT	QG4	1.2V	-40° to +125°C	6-Pin 2mm x 2mm Thin MLF [®]	Pb-Free
MIC5325-1.5YMT	QGF	1.5V	-40° to +125°C	6-Pin 2mm x 2mm Thin MLF [®]	Pb-Free
MIC5325-1.8YMT	QGG	1.8V	-40° to +125°C	6-Pin 2mm x 2mm Thin MLF [®]	Pb-Free

Note:

1. Other voltages available. Contact Micrel for details.
2. Contact Marketing for ADJ version availability.
3. ▲ = Pin 1 identifier.

Pin Configuration

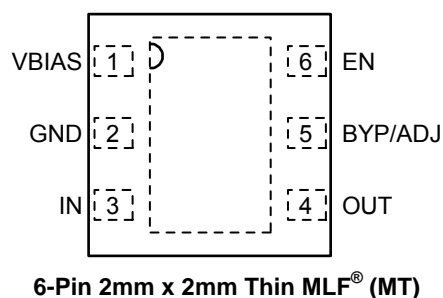

Pin Description

Pin Number	Pin Name	Pin Function
1	VBIAS	Bias Input Voltage.
2	GND	Ground
3	IN	Power Input for LDO.
4	OUT	Output of regulator.
5	BYP/ADJ	Bypass: Connect a capacitor to ground to reduce noise and reduce ripple rejection. Adjust: Feedback input from external resistor divider.
6	EN	Enable Input: Active High Input. Logic High = On; Logic Low = Off; Do not leave floating.

Absolute Maximum Ratings⁽¹⁾

Supply Voltage (V_{IN})	0V to V_{BIAS}
Bias Voltage (V_{BIAS})	0V to 6V
Enable Voltage (V_{EN})	0V to V_{BIAS}
Power Dissipation (P_D)	Internally Limited ⁽³⁾
Lead Temperature (soldering, 10 μ sec.)	260°C
Storage Temperature (T_s)	-65°C to +150°C
ESD Rating ⁽⁴⁾	2kV

Operating Ratings⁽²⁾

Supply Voltage (V_{IN})	1.7V to V_{BIAS}
Bias Voltage (V_{BIAS})	2.5V to 5.5V
Enable Voltage (V_{EN})	0V to V_{BIAS}
Junction Temperature (T_J)	-40°C to +125°C
Junction Thermal Resistance	
2x2 Thin MLF-6 (θ_{JA})	90°C/W

Electrical Characteristics⁽⁵⁾

$V_{BIAS} = 3.6V$; $V_{IN} = V_{OUT} + 1V$; $C_{OUT} = 1\mu F$; $I_{OUT} = 100\mu A$; $T_J = 25^\circ C$, **bold** values indicate -40°C to +125°C, unless noted.

Parameter	Condition	Min	Typ	Max	Units
Output Voltage Accuracy	Variation from nominal V_{OUT}	-2.0		+2.0	%
Reference Voltage	ADJ pin voltage	0.7595	0.775	0.7905	V
V_{BIAS} Line Regulation	$V_{BIAS} = 3.6V$ to 5.5V, $V_{IN} = V_{OUT} + 1V$		0.03	0.6	%/V
V_{IN} Line Regulation	$V_{BIAS} = 3.6V$ to 5.5V, $V_{IN} = V_{OUT} + 1V$ to 5.5V		0.02	0.6	%/V
Load Regulation	$I_{OUT} = 100\mu A$ to 400mA		0.3	2	%
V_{IN} Dropout Voltage	$I_{OUT} = 400mA$		110	250	mV
Ground Pin Current	$I_{OUT} = 100\mu A$ to 400mA, $V_{IN} = V_{EN}$, $V_{BIAS} = 5.5V$		35	55	μA
Ground Pin Current in Shutdown	$V_{EN} \leq 0.2V$		0.01	1	μA
Ripple Rejection	$f =$ up to 1kHz; $C_{OUT} = 1.0\mu F$; no C_{BYP}		60		dB
	$f =$ up to 1kHz; $C_{OUT} = 1.0\mu F$; $C_{BYP} = 10nF$	50	65		dB
	$f = 1kHz - 20kHz$; $C_{OUT} = 1.0\mu F$; $C_{BYP} = 10nF$		40		dB
Current Limit	$V_{OUT} = 0V$	450	680		mA
Output Voltage Noise	$C_{OUT} = 1\mu F$, $C_{BYP} = 10nF$, 10Hz to 100kHz		30		μV_{RMS}
Enable Inputs (EN)					
Enable Input Voltage	Logic Low			0.2	V
	Logic High	1.2			V
Enable Input Current	$V_{IL} \leq 0.2V$		0.01		μA
	$V_{IH} \geq 1.0V$		0.02		μA
Turn-on Time	$C_{OUT} = 1\mu F$; $C_{BYP} = 10nF$		150	500	μs

Notes:

- Exceeding the absolute maximum rating may damage the device.
- The device is not guaranteed to function outside its operating rating.
- The maximum allowable power dissipation of any T_A (ambient temperature) is $P_{D(max)} = T_{J(max)} - T_A / \theta_{JA}$. Exceeding the maximum allowable power dissipation will result in excessive die temperature, and the regulator will go into thermal shutdown.
- Devices are ESD sensitive. Handling precautions recommended. Human body model, 1.5k in series with 100pF.
- Specification for packaged product only.

Typical Characteristics

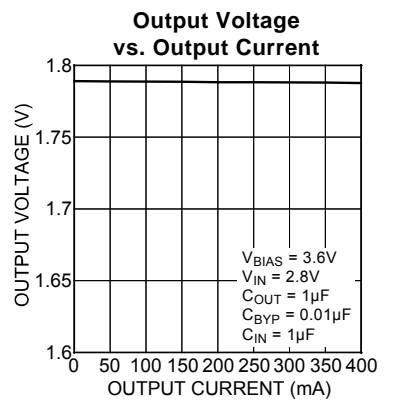
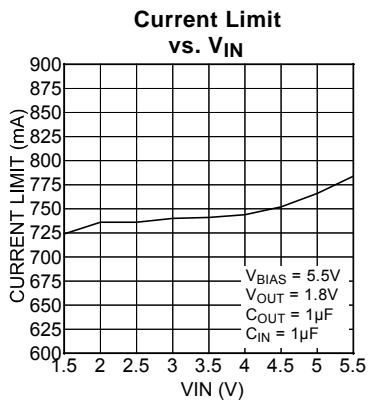
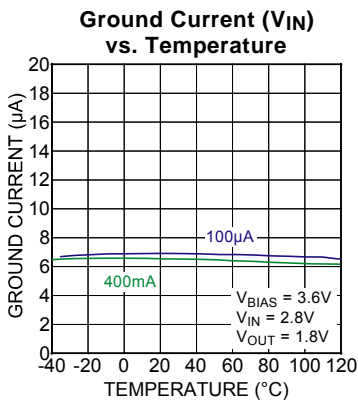
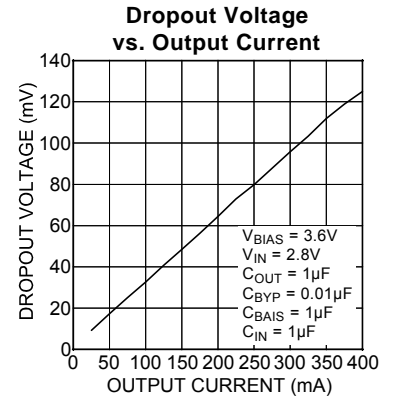
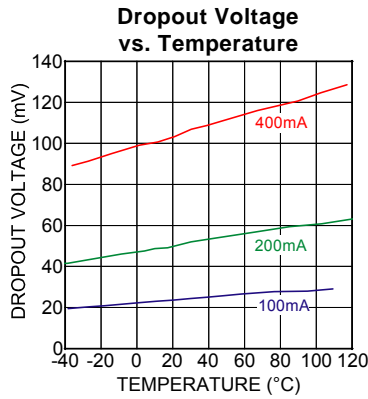
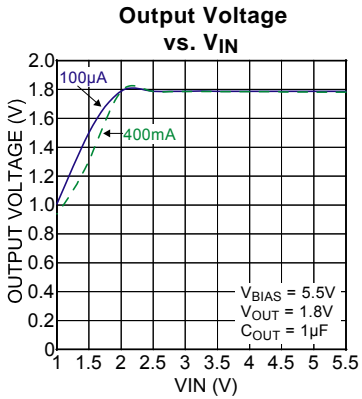
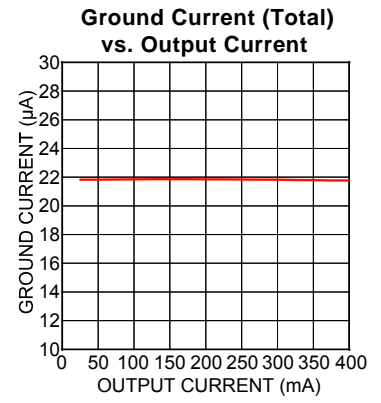
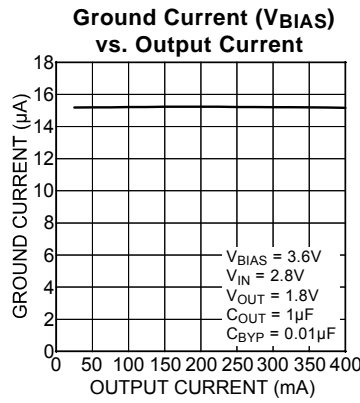
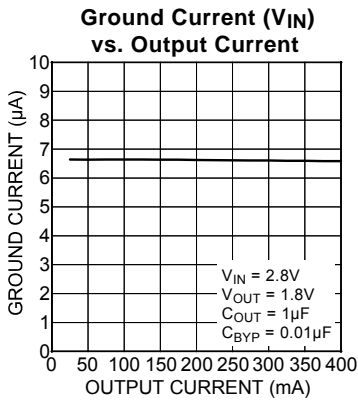
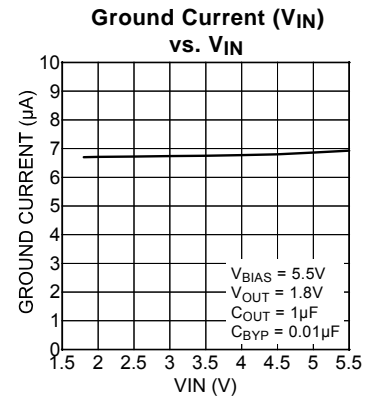
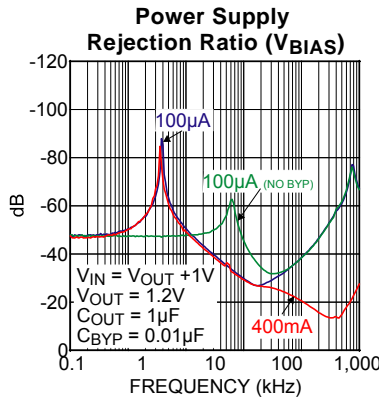
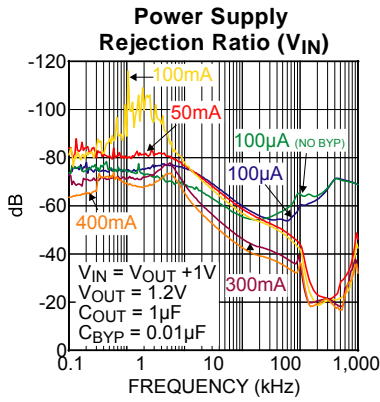

Typical Characteristics (continued)

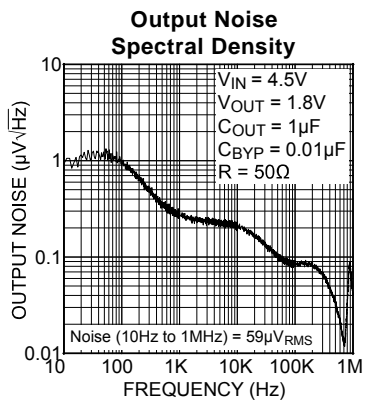
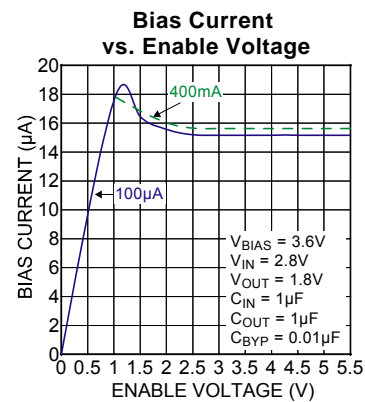
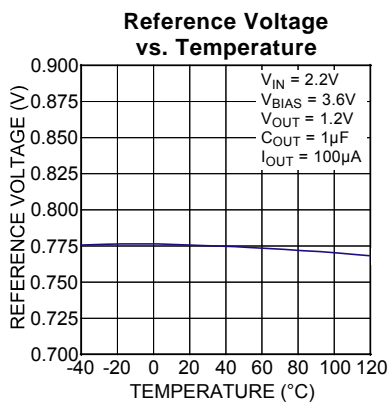
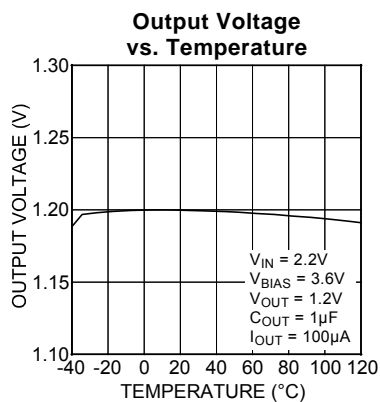

Functional Characteristics

Line Transient (V_{BIAS})

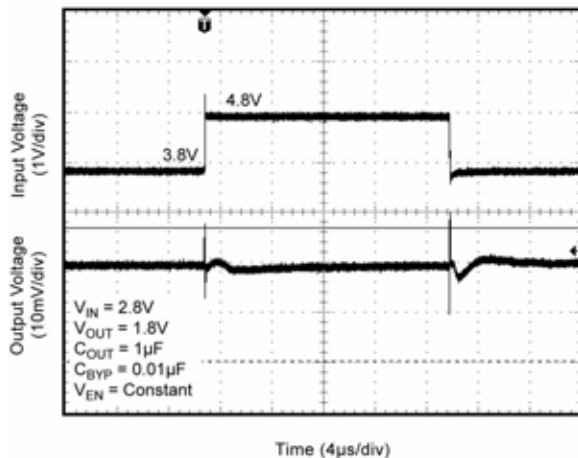

Line Transient (V_{IN})

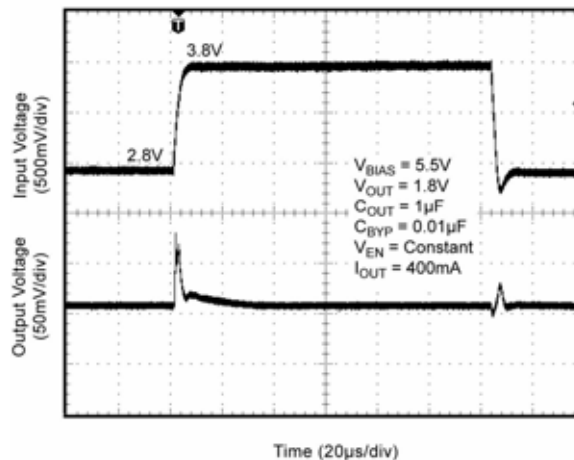

Load Transient (V_{IN})

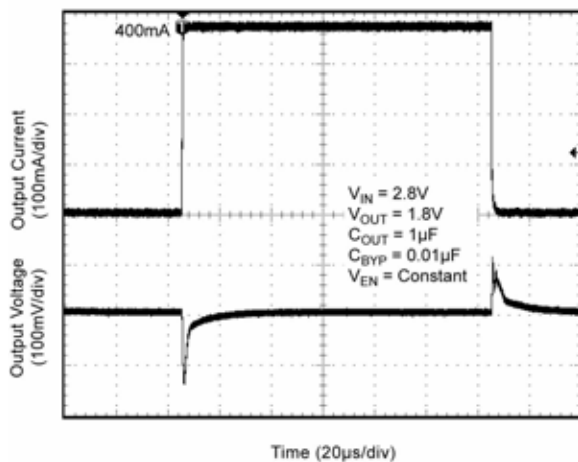

Turn-on Time

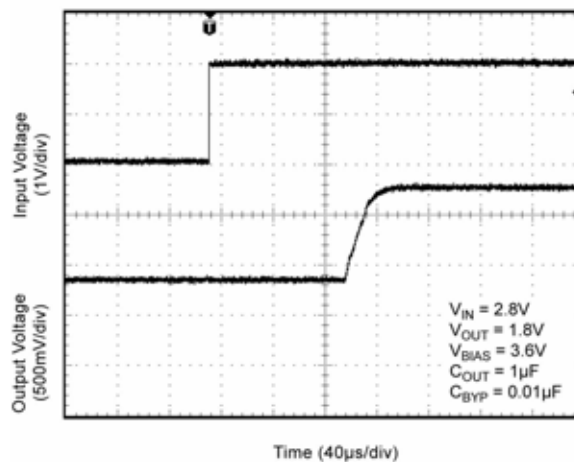

Functional Diagram

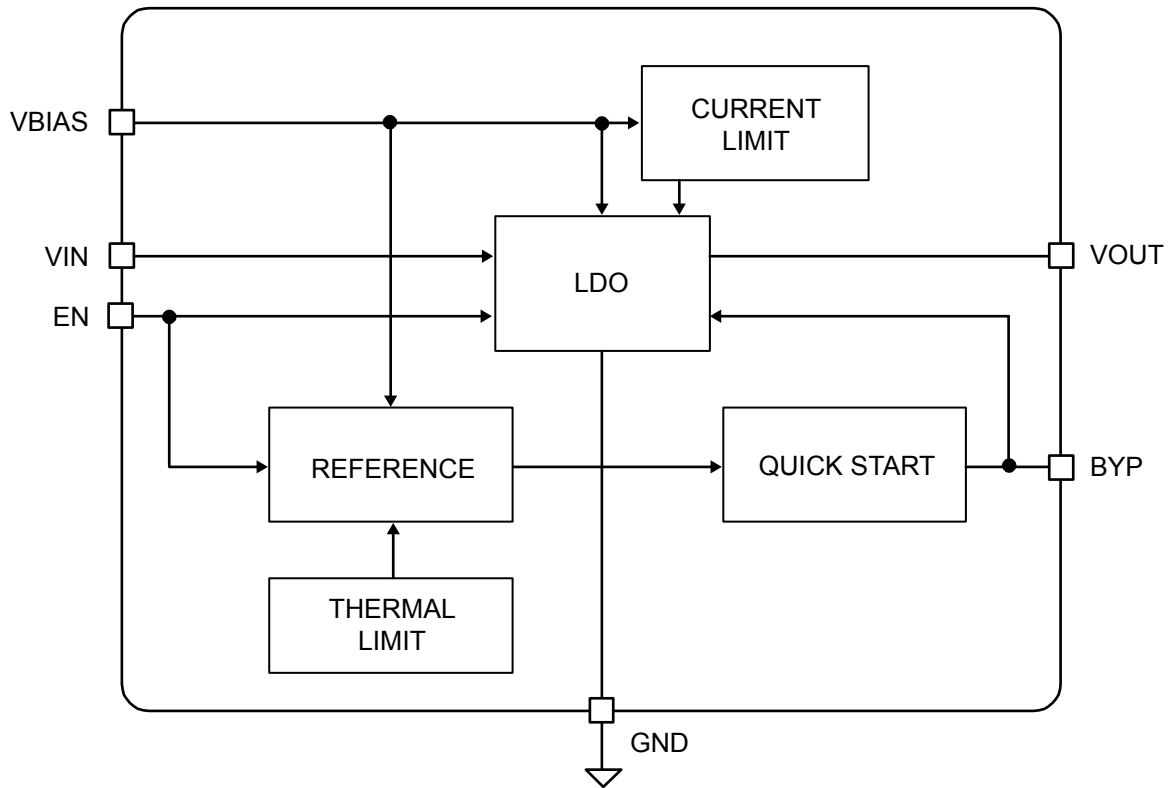

Application Information

The MIC5325 is a high performance, low-dropout linear regulator designed for low current applications requiring fast transient response. The MIC5325 utilizes two input supplies, significantly reducing dropout voltage, perfect for low-voltage, DC-to-DC conversion. The MIC5325 requires a minimum of external components.

The MIC5325 regulator is fully protected from damage due to fault conditions, offering linear current limiting and thermal shutdown.

Bias Supply Voltage

V_{BIAS} , requiring relatively light current, provides power to the control portion of the MIC5325. Bypassing on the bias pin is recommended to improve performance of the regulator during line and load transients. 1 μ F ceramic capacitor from V_{BIAS} -to-ground helps reduce high frequency noise from being injected into the control circuitry from the bias rail and is good design practice.

Input Supply Voltage

V_{IN} provides the supply to power the LDO. The minimum input voltage is 1.7V, allowing conversion from low voltage supplies.

Output Capacitor

The MIC5325 requires an output capacitor of 1 μ F or greater to maintain stability. The design is optimized for use with low-ESR ceramic chip capacitors. High ESR capacitors may cause high frequency oscillation. The output capacitor can be increased, but performance has been optimized for a 1 μ F ceramic output capacitor and does not improve significantly with larger capacitance.

X7R/X5R dielectric-type ceramic capacitors are recommended because of their temperature performance. X7R-type capacitors change capacitance by 15% over their operating temperature range and are the most stable type of ceramic capacitors. Z5U and Y5V dielectric capacitors change value by as much as 50% and 60%, respectively, over their operating temperature ranges. To use a ceramic chip capacitor with Y5V dielectric, the value must be much higher than an X7R ceramic capacitor to ensure the same minimum capacitance over the equivalent operating temperature range.

Input Capacitor

The MIC5325 is a high-performance, high bandwidth device. Therefore, it requires a well-bypassed input supply for optimal performance. A 1 μ F capacitor is required from the input-to-ground to provide stability. Low-ESR ceramic capacitors provide optimal performance at a minimum of space. Additional high-frequency capacitors, such as small-valued NPO dielectric-type capacitors, help filter out high-frequency noise and are good practice in any RF-based circuit.

Bypass Capacitor

A capacitor can be placed from the noise bypass pin-to-ground to reduce output voltage noise. The capacitor bypasses the internal reference. A 0.01 μ F capacitor is recommended for applications that require low-noise outputs. The bypass capacitor can be increased, further reducing noise and improving PSRR. Turn-on time increases slightly with respect to bypass capacitance. A unique, quick-start circuit allows the MIC5325 to drive a large capacitor on the bypass pin without significantly slowing turn-on time.

Minimum Load Current

The MIC5325, unlike most other regulators, does not require a minimum load to maintain output voltage regulation.

Enable/Shutdown

The MIC5325 comes with a single active-high enable pin that allows the regulator to be disabled. Forcing the enable pin low disables the regulator and sends it into a "zero" off-mode-current state. In this state, current consumed by the regulator goes nearly to zero. Forcing the enable pin high enables the output voltage. The active-high enable pin uses CMOS technology and the enable pin cannot be left floating; a floating enable pin may cause an indeterminate state on the output.

Thermal Considerations

The MIC5325 is designed to provide 400mA of continuous current in a very small package. Maximum ambient operating temperature can be calculated based on the output current and the voltage drop across the part. Given that the input voltage is 1.8V, the output voltage is 1.2V and the output current = 400mA. The actual power dissipation of the regulator circuit can be determined using the equation:

$$P_D = (V_{IN} - V_{OUT1}) I_{OUT} + V_{IN} I_{GND}$$

Because this device is CMOS and the ground current is typically <100 μ A over the load range, the power dissipation contributed by the ground current is < 1% and can be ignored for this calculation.

$$P_D = (1.8V - 1.2V) \times 400mA$$

$$P_D = 0.18W$$

To determine the maximum ambient operating temperature of the package, use the junction-to-ambient thermal resistance of the device and the following basic equation:

$$P_{D(max)} = \left(\frac{T_{J(max)} - T_A}{\theta_{JA}} \right)$$

$T_{J(max)} = 125^\circ\text{C}$, the maximum junction temperature of the die θ_{JA} thermal resistance = 90°C/W .

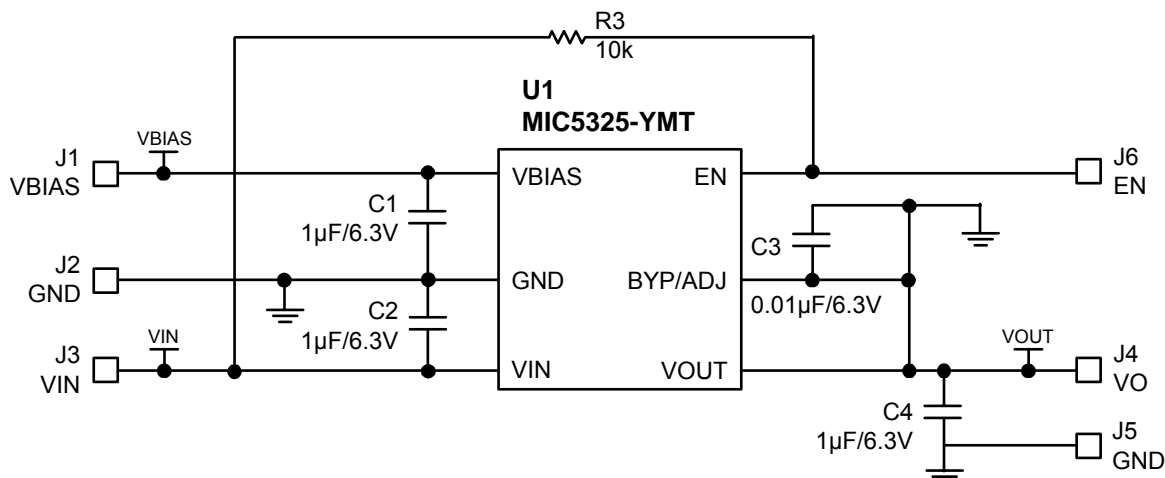

Bill of Materials

Item	Part Number	Manufacturer	Description	Qty.
C1, C2, C4	VJ0603G105KXYCW1BC	Vishay ⁽¹⁾	Capacitor, 1µF, 6.3V, Size 0603	3
C3	VJ0603Y103KXQCW1BC	Murata ⁽²⁾	Capacitor, 0.01µF, 10V, Size 0603	1
R3	CRCW060310K0FKEA	Vishay Dale ⁽¹⁾	Resistor, 10k, 1%, 1/16W, Size 0603	1
U1	MIC5325-xxYMT	Micrel, Inc. ⁽³⁾	400mA ULDO™ with Ultra Low IQ	1

Notes:

1. Vishay: www.vishay.com
2. Murata: www.murata.com
3. Micrel, Inc.: www.micrel.com

PCB Layout Recommendations

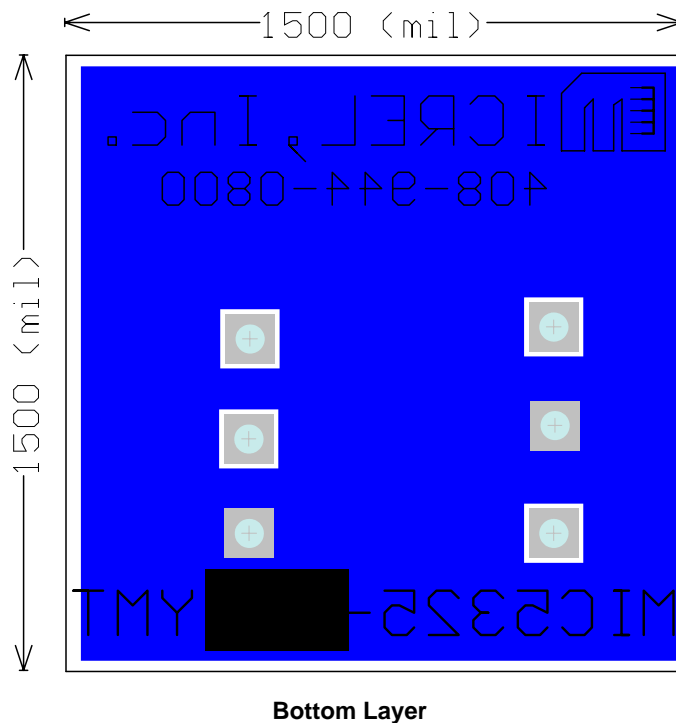
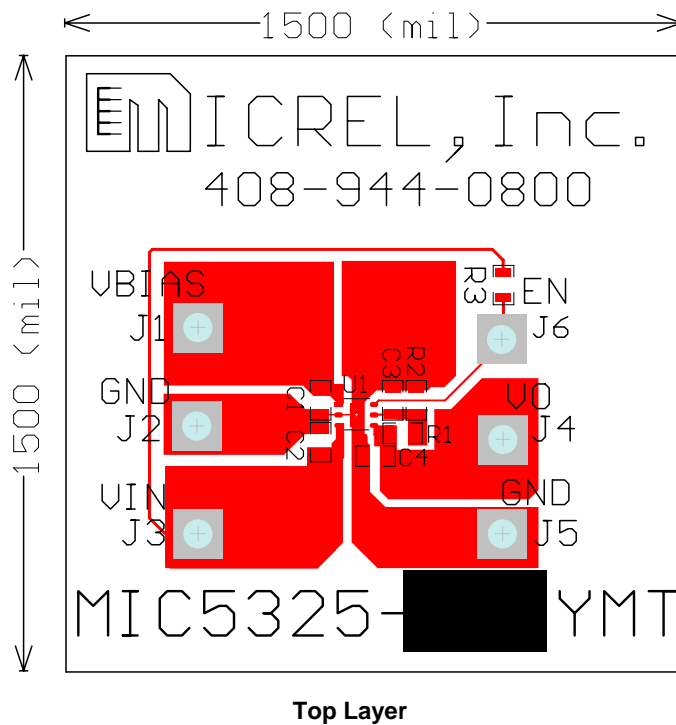

Package Information

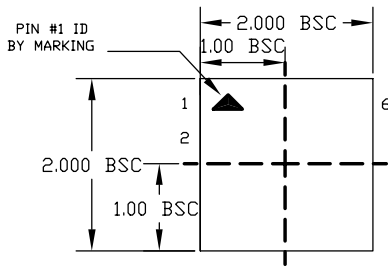

TOP VIEW

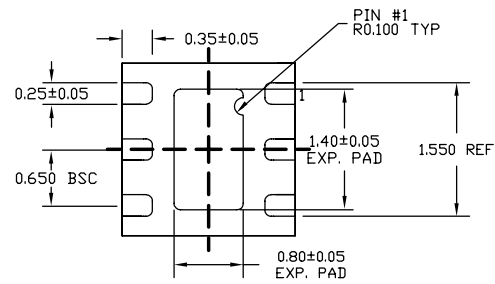

BOTTOM VIEW

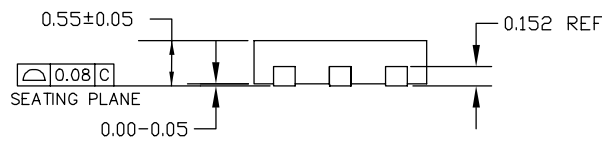

SIDE VIEW

NOTE:

1. ALL DIMENSIONS ARE IN MILLIMETERS.
2. MAX. PACKAGE WARPAGE IS 0.08 mm.
3. MAXIMUM ALLOWABLE BURRS IS 0.076 mm IN ALL DIRECTIONS.
4. PIN #1 ID ON TOP WILL BE LASER MARKED.

6-Pin 2mm x 2mm Thin MLF[®] (MT)

MICREL, INC. 2180 FORTUNE DRIVE SAN JOSE, CA 95131 USA
 TEL +1 (408) 944-0800 FAX +1 (408) 474-1000 WEB <http://www.micrel.com>

The information furnished by Micrel in this data sheet is believed to be accurate and reliable. However, no responsibility is assumed by Micrel for its use. Micrel reserves the right to change circuitry and specifications at any time without notification to the customer.

Micrel Products are not designed or authorized for use as components in life support appliances, devices or systems where malfunction of a product can reasonably be expected to result in personal injury. Life support devices or systems are devices or systems that (a) are intended for surgical implant into the body or (b) support or sustain life, and whose failure to perform can be reasonably expected to result in a significant injury to the user. A Purchaser's use or sale of Micrel Products for use in life support appliances, devices or systems is a Purchaser's own risk and Purchaser agrees to fully indemnify Micrel for any damages resulting from such use or sale.

© 2007 Micrel, Incorporated.