

### Features

- Low Turn-on Voltage
- Fast Switching
- PN Junction Guard Ring for Transient and ESD Protection
- Lead Free/RoHS Compliant (Note 3)**
- Qualified to AEC-Q101 Standards for High Reliability**

### Mechanical Data

- Case: SOT-23
- Case Material: Molded Plastic. UL Flammability Classification Rating 94V-0
- Moisture sensitivity: Level 1 per J-STD-020C
- Terminals: Solderable per MIL-STD-202, Method 208
- Lead Free Plating (Matte Tin Finish annealed over Alloy 42 leadframe)
- Polarity: See Diagrams Below
- Marking: See Diagrams Below & Page 3
- Ordering Information: See Page 3
- Weight: 0.008 grams (approximate)

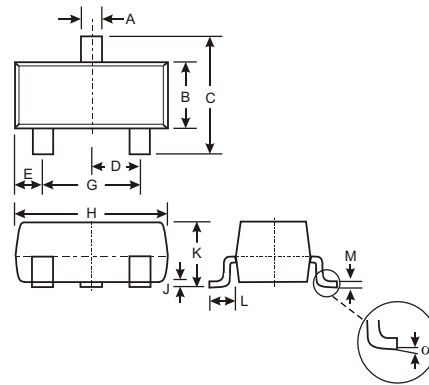

SOT-23		
Dim	Min	Max
A	0.37	0.51
B	1.20	1.40
C	2.30	2.50
D	0.89	1.03
E	0.45	0.60
G	1.78	2.05
H	2.80	3.00
J	0.013	0.10
K	0.903	1.10
L	0.45	0.61
M	0.085	0.180
	0	8
<b>All Dimensions in mm</b>		

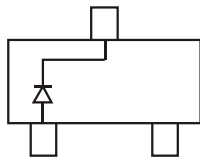

BAS70 Marking: K73, K7C

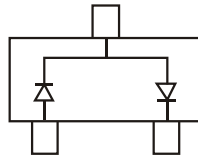

BAS70-04 Marking: K74, K7D

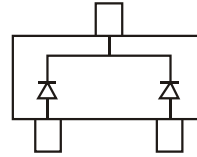

BAS70-05 Marking: K75, K7E

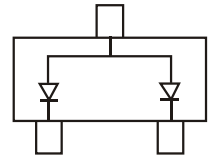

BAS70-06 Marking: K76, K7F

### Maximum Ratings and Electrical Characteristics, Single Diode @ T<sub>A</sub> = 25 °C unless otherwise specified

Characteristic	Symbol	Value	Unit
Peak Repetitive Reverse Voltage	V <sub>RRM</sub>	70	V
Working Peak Reverse Voltage	V <sub>RWM</sub>		
DC Blocking Voltage	V <sub>R</sub>		
RMS Reverse Voltage	V <sub>R(RMS)</sub>	49	V
Maximum Forward Continuous Current (Note 1)	I <sub>FM</sub>	70	mA
Non-Repetitive Peak Forward Surge Current @ t = 1.0s	I <sub>FSM</sub>	100	mA
Power Dissipation (Note 1)	P <sub>d</sub>	200	mW
Thermal Resistance Junction to Ambient Air (Note 1)	R <sub>JA</sub>	625	°C/W
Operating Junction Temperature Range	T <sub>J</sub>	-55 to +125	°C
Storage Temperature Range	T <sub>STG</sub>	-65 to +150	°C

### Electrical Ratings @ T<sub>A</sub> = 25 °C unless otherwise specified

Characteristic	Symbol	Min	Max	Unit	Test Condition
Reverse Breakdown Voltage (Note 2)	V <sub>(BR)R</sub>	70	—	V	I <sub>R</sub> = 10
Forward Voltage	V <sub>F</sub>	—	410 1000	mV	t <sub>p</sub> < 300µs, I <sub>F</sub> = 1.0mA t <sub>p</sub> < 300µs, I <sub>F</sub> = 15mA
Reverse Current (Note 2)	I <sub>R</sub>	—	100	nA	t <sub>p</sub> < 300µs, V <sub>R</sub> = 50V
Total Capacitance	C <sub>T</sub>	—	2.0	pF	V <sub>R</sub> = 0V, f = 1.0MHz
Reverse Recovery Time	t <sub>rr</sub>	—	5.0	ns	I <sub>F</sub> = I <sub>R</sub> = 10mA to I <sub>R</sub> = 1.0mA, R <sub>L</sub> = 100

- Notes:
- Part mounted on FR-4 board with recommended pad layout, which can be found on our website at <http://www.diodes.com/datasheets/ap02001.pdf>.
  - Short duration pulse test used to minimize self-heating effect.
  - No purposefully added lead.

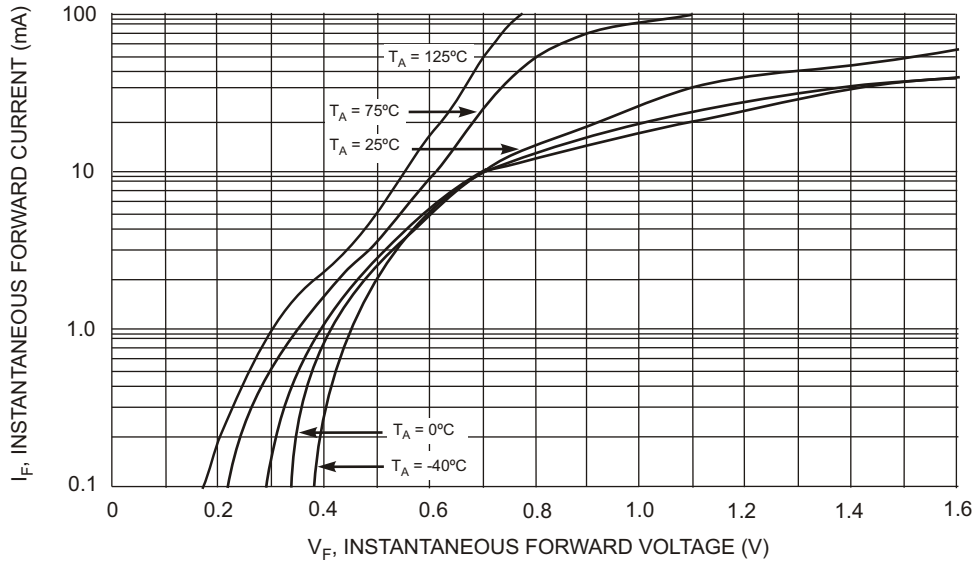

Fig. 1 Typical Forward Characteristics

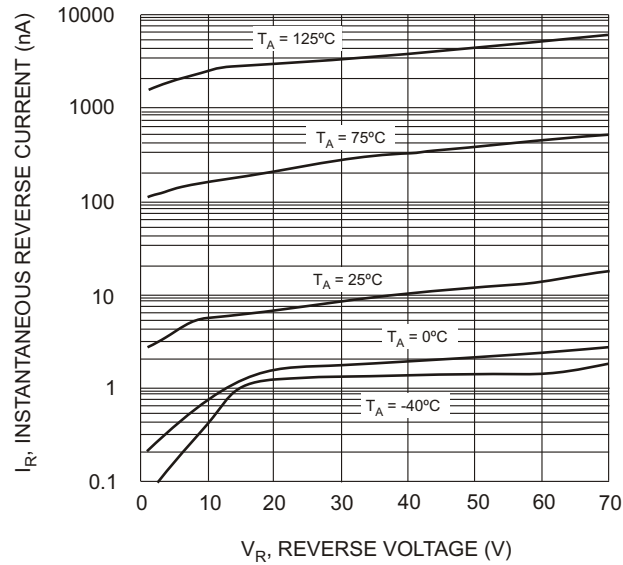

Fig. 2 Typical Reverse Characteristics

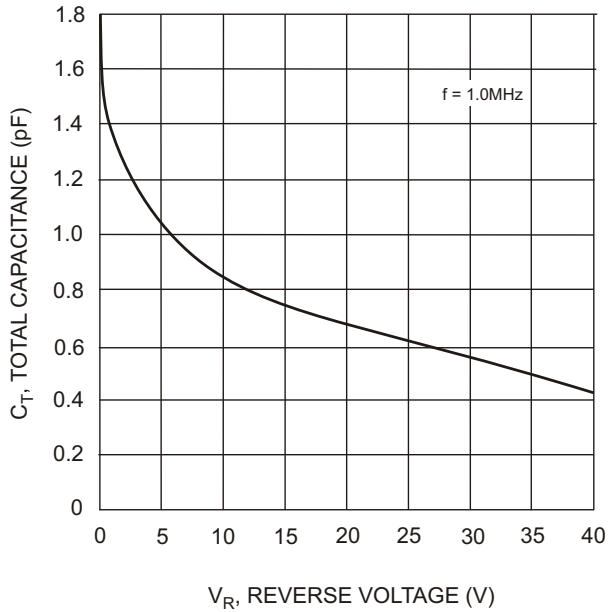

Fig. 3 Typical Total Capacitance vs. Reverse Voltage

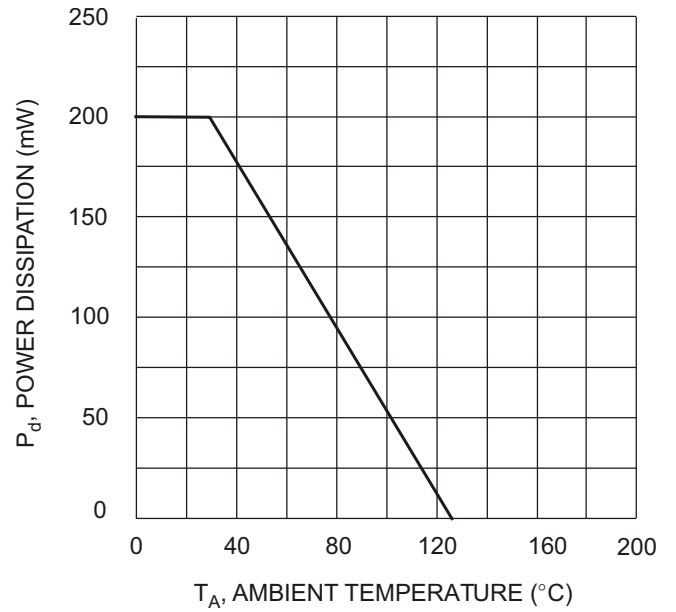

Fig. 4 Power Derating Curve, Total Package

**Ordering Information** (Note 4)

Device	Packaging	Shipping
BAS70-7-F	SOT-23	3000/Tape & Reel
BAS70-04-7-F	SOT-23	3000/Tape & Reel
BAS70-05--7-F	SOT-23	3000/Tape & Reel
BAS70-06-7-F	SOT-23	3000/Tape & Reel

Notes: 4. For Packaging Details, go to our website at <http://www.diodes.com/datasheets/ap02007.pdf>.

**Marking Information**

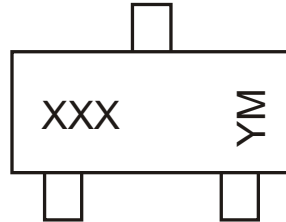

XXX = Product Type Marking Code (See Page 1)  
 YM = Date Code Marking  
 Y = Year ex: T = 2006  
 M = Month ex: 9 = September

Date Code Key

Year	2001	2002	2003	2004	2005	2006	2007	2008	2009	2010	2011	2012
Code	M	N	P	R	S	T	U	V	W	X	Y	Z

Month	Jan	Feb	Mar	Apr	May	Jun	Jul	Aug	Sep	Oct	Nov	Dec
Code	1	2	3	4	5	6	7	8	9	O	N	D

**IMPORTANT NOTICE**

Diodes Incorporated and its subsidiaries reserve the right to make modifications, enhancements, improvements, corrections or other changes without further notice to any product herein. Diodes Incorporated does not assume any liability arising out of the application or use of any product described herein; neither does it convey any license under its patent rights, nor the rights of others. The user of products in such applications shall assume all risks of such use and will agree to hold Diodes Incorporated and all the companies whose products are represented on our website, harmless against all damages.

**LIFE SUPPORT**

Diodes Incorporated products are not authorized for use as critical components in life support devices or systems without the expressed written approval of the President of Diodes Incorporated.