

Amphenol

Amphenol-Tuchel Electronics GmbH

Circular Connectors Series C 16-1/C 16-3



The Company

Amphenol-Tuchel Electronics GmbH is a member of the USA based Amphenol Corporation. With our own global presence we offer our customers exceptional technical support and service in the areas of development, production and distribution. Amphenol-Tuchel Electronics GmbH has a successful history as a partner to our customers and sets standards for connector technology.



Quality

From the beginning of the development process, Amphenol-Tuchel Electronics GmbH gives quality considerations the top priority. Meeting customer requirements is the main focus of the product development process.

Interdisciplinary project teams with diverse backgrounds from marketing, product engineering and production guarantee the development and production of robust and reliable connector solutions.

Our quality assessment begins with the initial contact to the customer and extends through the life of the product. A satisfied customer is the measure of our success.

Amphenol-Tuchel Electronics GmbH is ISO 9001, QS 9000 and VDA 6.1 certified.

We strive to use environmentally friendly processes that minimize the waste of natural resources and introduction of toxins into the environment. Amphenol-Tuchel is an ISO 14001 certified company.

General information

We reserve the right to change the design due to improvement in quality, development or production requirements.

With this release all former releases are no longer valid.

This catalogue must not be used in any form or manner without our prior approval in writing (Copyright Law, Fair Trading Law, Civil Code).

Content

Page

General information

2

Technical information

4

Remarks/Safety classification

7

Series C 16-1



View

8

Product description
Order information
Approvals

9

Characteristics

10

Derating curves
Mounting instructions

11

Male cable connectors

12

Female receptacles

13

Female cable connectors

14

Male receptacles

15

Accessories

16

View

17

Product description
Order information
Approvals

18

Coding system

19

Characteristics

20

Derating curves

21

View of connector style

22

Mounting instruction

23

Shell size 1

Male cable connectors

24

Female receptacles

25

Female cable connectors

Male receptacles

26

Accessories

EMI versions

27

Shell size 2

Male cable connectors

30

Female receptacles

Female cable connectors

31

Male receptacles

Accessories

32

Crimp contacts pin

33

Crimp contacts socket

34

Part No. system for crimp contacts

35

Summary of Part Numbers

36

Termination methods

• **Screw connection**

Screw clamps are designed acc. to EN 60999-1/VDE 06095.1. Chart 1 below shows the screw size depending on wire size and the required clamping and testing torque.

Chart 1

Wire size (mm ²)	1	1,5	2,5	4	6	10
Screw size	M 2,6	M 3	M 3	M 3,5	M 4	M 4
Test torque (Ncm)	40	50	50	80	120	120

Diagram 1 below shows the range of tensile strength for a screw connection with a clamp screw M3, fastened with a torque of 50 Ncm, depending on the wire size.

Diagram 1

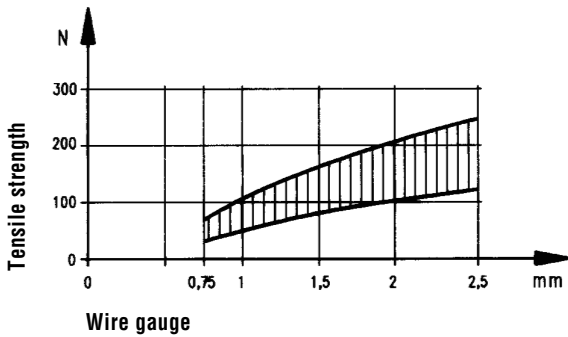

This comparison chart allows a cross reference between American Wire Gauge (AWG) and metric wire sizes (mm²).

Chart 2

AWG	Wire composition	Wire diameter	Wire size
30	1 x 0,25 7 x 0,10	0,25 mm 0,36 mm	0,05 mm ² 0,06 mm ²
28	1 x 0,32 7 x 0,13	0,32 mm 0,38 mm	0,08 mm ² 0,09 mm ²
26	1 x 0,40 7 x 0,16 19 x 0,10	0,40 mm 0,48 mm 0,51 mm	0,13 mm ² 0,14 mm ² 0,15 mm ²
24	1 x 0,51 7 x 0,20 19 x 0,13	0,51 mm 0,61 mm 0,64 mm	0,21 mm ² 0,23 mm ² 0,24 mm ²
22	1 x 0,64 7 x 0,25 19 x 0,16	0,64 mm 0,76 mm 0,81 mm	0,33 mm ² 0,36 mm ² 0,38 mm ²
20	1 x 0,81 7 x 0,32 19 x 0,20	0,81 mm 0,97 mm 1,02 mm	0,52 mm ² 0,56 mm ² 0,62 mm ²
18	1 x 1,02 19 x 0,25	1,02 mm 1,27 mm	0,79 mm ² 0,96 mm ²
16	19 x 0,29	1,44 mm	1,23 mm ²
14	19 x 0,36	1,80 mm	1,95 mm ²
12	19 x 0,46	2,29 mm	3,09 mm ²
10	37 x 0,40	3,10 mm	4,60 mm ²
8	133 x 0,29	4,0 mm	8,80 mm ²
6	133 x 0,36	5,5 mm	13,5 mm ²

It has to be noted that wires of the same AWG number but with different composition have slightly different mm².

Chart 3

Composition and Dimensions of Copper Wires

Wire Size	Wire Composition	Wire diameter
0,09 mm ²	12 x 0,10	0,48 mm
0,14 mm ²	18 x 0,10	0,50 mm
0,25 mm ²	14 x 0,15	0,70 mm
0,34 mm ²	7 x 0,25	0,78 mm
0,5 mm ²	16 x 0,20	1,0 mm
0,75 mm ²	24 x 0,20	1,2 mm
1,0 mm ²	32 x 0,20	1,4 mm
1,5 mm ²	30 x 0,25	1,6 mm
2,5 mm ²	35 x 0,30	2,2 mm
4,0 mm ²	56 x 0,30	2,8 mm
6,0 mm ²	19 x 0,64	3,4 mm
10 mm ²	19 x 0,80	4,3 mm

• Crimp connection

A crimp connection is a non-detachable electrical connection between a wire and a crimp contact produced with the crimp technology. Precise crimping dies which are matched to the crimp barrel and the wire size and a defined deformation result in a reliable electrical connection.

There are open crimp barrels (stamped contacts) and closed crimp barrels (turned contacts).

The main advantages of crimp connections are:

- Efficient termination of contacts.
- Reproducible electrical and mechanical figures with a constant crimp quality.

The requirements for crimp connections are defined in IEC 60352 Part 2 / DIN EN 60352 Part 2.

An important point of the quality of a crimp connection is the achieved tensile strength of the termination.

Easily measured, the tensile strength is a practicable means for quality control purposes.

Diagram 2 below shows the required minimum tensile strength for open and closed barrels depending on the wire size.

Assembly instructions

For crimp contacts use the released crimp tool.

The insertion and extraction of crimp contacts shall only be approved with the corresponding insertion/extraction tool.

A detailed description of the crimp technology can be found in our crimp tooling catalogs.

Diagram 2

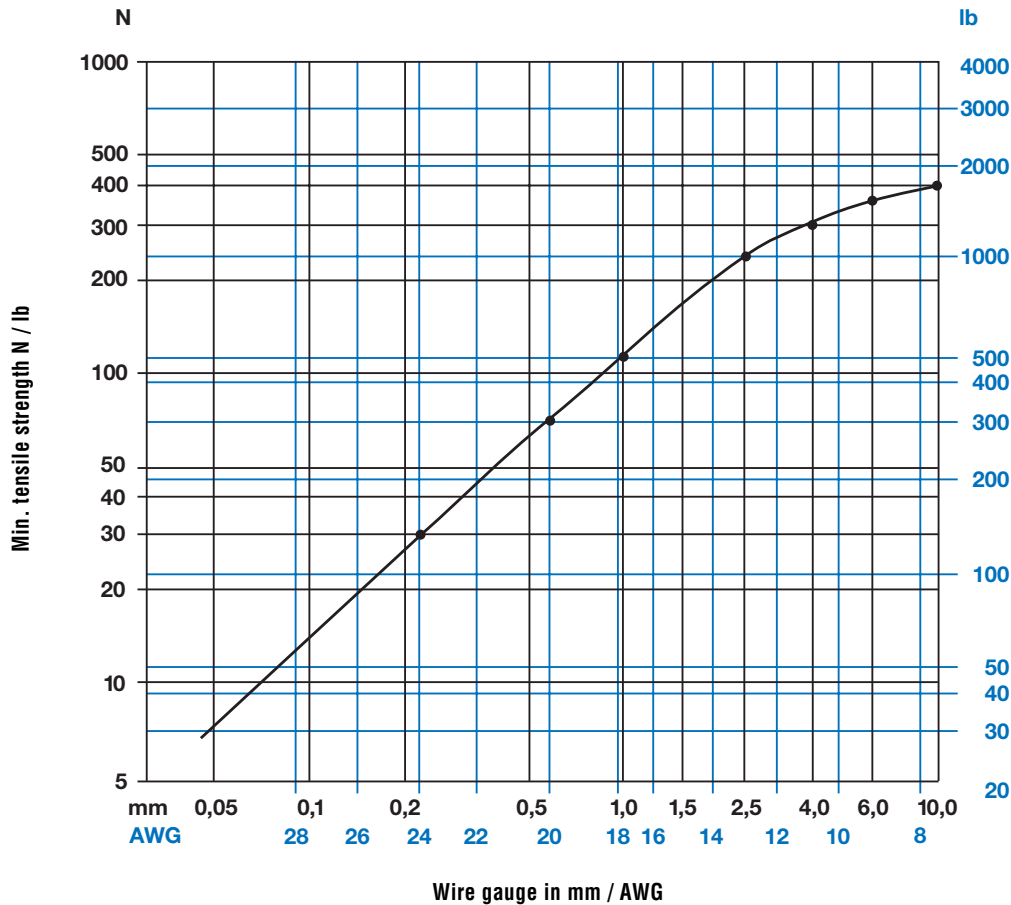

Degree of protection

Electrical devices to which connectors belong to have to be protected for safety reasons from outside influences like dust, foreign objects, direct contact, moisture and water. This protection is provided on industrial connectors by its housings with their latching devices and sealed cable entries. The degree of protection can be selected depending on the type of intended use. The standard IEC 60529 and/or DIN EN 60529/VDE 0470 Part 1 has specified the degree of protection and divided into several classes.

The degree of protection is indicated in the following way:

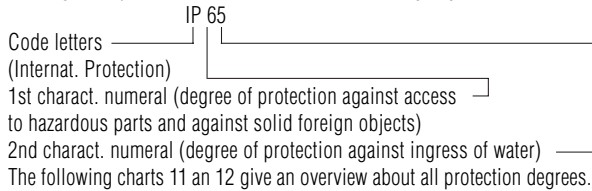

Chart 4

1st charact. numeral	Brief description	Definition
0	Non-protected	–
1	Protected against access to hazardous parts with the back of a hand. Protected against solid foreign objects of $\geq 50\text{mm } \varnothing$.	The probe, sphere of $50\text{mm } \varnothing$, shall not fully penetrate and shall have adequate clearance from hazardous parts.
2	Protected against access to hazardous parts with a finger. Protected against solid foreign objects of $\geq 12,5\text{mm } \varnothing$.	The jointed test finger of $12\text{mm } \varnothing$, 80mm length, shall have adequate clearance from hazardous parts. The probe, sphere of $12,5\text{mm } \varnothing$, shall not fully penetrate.
3	Protected against access to hazardous parts with a tool. Protected against solid foreign objects of $\geq 2,5\text{mm } \varnothing$.	The probe of $2,5\text{mm } \varnothing$ shall not penetrate at all.
4	Protected against access to hazardous parts with a wire. Protected against solid foreign objects of $\geq 1\text{mm } \varnothing$.	The probe of $1\text{mm } \varnothing$ shall not penetrate at all.
5	Protected against access to hazardous parts with a wire. Dust-protected.	The probe of $1\text{mm } \varnothing$ shall not penetrate. Intrusion of dust is not totally prevented, but dust shall not penetrate in a quantity to interfere with satisfactory operation of the device or to impair safety.
6	Protected against access to hazardous parts with a wire. Dust-tight.	The probe of $1\text{mm } \varnothing$ shall not penetrate. No intrusion of dust.

Chart 5

2nd charact. numeral	Brief description	Definition
0	Non-protected	–
1	Protected against vertically falling water drops	Vertically falling drops shall have no harmful effects.
2	Protected against vertically falling water drops when enclosure tilted up to 15°	Vertically falling drops shall have no harmful effects when the enclosure is tilted at any angle up to 15° on either side of the vertical.
3	Protected against spraying water	Water sprayed at an angle up to 60° on either side of the vertical shall have no harmful effects.
4	Protected against splashing water	Water splashed against the enclosure from any direction shall have no harmful effects.
5	Protected against water jets	Water projected in jets against the enclosure from any direction shall have no harmful effects.
6	Protected against powerful water jets	Water projected in powerful jets against the enclosure from any direction shall have no harmful effects.
7	Protected against the effects of temporary immersion in water	Intrusion of water in quantities causing harmful effects shall not be possible when the enclosure is temporarily immersed in water for 30 min. in 1m depth.
8	Protected against the effects of continuous immersion in water	Intrusion of water in quantities causing harmful effects shall not be possible when the enclosure is continuously immersed in water under conditions which shall be agreed between manufacturer and user but which are more severe than for numeral 7.
9 K ¹⁾	Protected against water during high pressure/steam jet cleaning	Water projected in powerful jets with high pressure against the enclosure from any direction shall have no harmful effects.

1) Remark: Numeral acc. to DIN 40050 part 9, vehicles IP code



1. General Remarks

These connectors are designed and produced in conformity with the low voltage directive (73/23/EWG) respectively Gerätesicherheitsgesetz (German law) and are especially in accordance with the standards DIN EN 61984 (VDE0627); IEC 60664-1 (VSE 0110-1) and IEC 60529. The connectors may be used only within the technical ratings. These connectors and/or plug and socket devices are designed and produced according to DIN EN 61984/VDE 0627. All technical data refer to mated connectors under live conditions. The safety of the connector system depends on the correct selection of products, proper assembly of the connector device, and a precise fit of the connectors.

2. Application Remarks

Connectors and/or plug and socket devices must be used according to specified technical ratings. The technical data represents the initial value of mated parts under predetermined conditions and length of time. These values could change with different test parameters or product requirements. The C 16-1/16-3 Series connectors are used in a wide variety of industries and equipment. Some of these include industrial machines and controls, data processing, instrumentation and test equipment, medical devices, telecommunication's network and equipment, plus outdoor and marine applications. All rated data for the connectors listed in this catalog are based on over-voltage category III¹⁾ and pollution degree 3²⁾ for electronic applications.

Connectors were completely mated according to their respective safety locking mechanism. Selection and testing of connectors and/or plug and socket devices to meet specific product or industrial requirements such as rated voltage and the related clearances and creepage distances are the responsibility of the user.

3. Assembling Remarks

Protection against electrical shock of the termination of the connectors shall be secured by correct mounting. Connectors of the same or different series being mounted side by side may be protected against incorrect mating by the use of coding options. Care must be taken to ensure the parts are correctly mated and screws are tightened with the proper torque.

4. Termination Remarks

Cable connectors are effectively secured when using the internal cable clamp. When the connector contains a simple gland bushing for retention without clamping ring the cable should have a strain relief close behind the connector. All cable properties or specifications must be compatible with the connector design and materials. Designated wire conductors must be terminated to the correct poles in the connector. Crimp contacts must be fully inserted into the plastic housing and retention assured with a slight tug on the wire. Wire should be stripped correctly according to printed specifications to insure no electrical contact can be made between the conductors. There should be no nicked or cut strains during the stripping action.

5. Safety Classification acc. to DIN EN 61984 VDE 0627

Style	enclosed mated	enclosed unmated	protective earthing contact	finger safety mated	finger safety unmated	hand back safety mated	connector with breaking capacity ¹⁾	rewirable	Cable clamp	
									with	without
Male cable connector	X	X	X	X		X	X	X	X	X
Female cable connector	X		X	X	X	X	X	X	X	X
Male receptacle screw / crimp	X	X	X	X		X	X	X		X
Female receptacle screw / crimp	X		X	X	X ³⁾	X	X	X		X
Male receptacle solder	X	X	X	X ³⁾		X ³⁾	X	X		X
Female receptacle solder	X		X	X ³⁾	X ³⁾	X ³⁾	X	X		X

¹⁾ Overvoltage category III: Equipment intended for the use in installations or parts of it in which lightning overvoltages do not need to be considered, however switching overvoltages generated by the equipment, and for cases where the reliability and the availability of the equipment or its dependent circuits are subject to special requirements. Examples are protecting means, switches and sockets.

²⁾ Pollution degree 3: Conductive pollution occurs or dry non-conductive pollution occurs which becomes conductive due to condensation which is to be expected.

³⁾ Protection against electrical shock on the termination side has to be secured by proper mounting.



Product description

The circular connectors of the C 16-1 series are designed to meet the high requirements of industrial applications under harsh environmental conditions. The range includes versions with screw, solder and crimp terminations. A selection of crimp contacts for hand crimp tools and crimp machines ensure a reliable termination resulting in qualitative, technical and economical advantages. A large selection of housing styles offers the user an optimal solution.

Main features and advantages:

- Circular connectors with contact arrangements 3 + PE and 6 + PE for power and signal applications
- For applications in machine tools, measurement and control, process technology and medical equipment
- Housing are made from high grade plastic material
- Protected against unlocking by threaded coupling
- Cable housing straight with PG 9, 11 and 13,5 cable outlet, Cable housing 90° with PG 9 and 11 cable outlet
- Cable housing straight or right-angled with various cable outlets¹⁾
- Protection degree IP 65/IP 67 per IEC 60529 in mated condition
- Internal strain relief with screw clamp or clamping ring provides a safe cable restrain

¹⁾ Other cable outlets upon request

C 16-1

Product description
Order information
Approvals

Order information

Contact plating

The standard plating is silver. Gold plated contacts are available upon request.
Min order quantity = 100 contacts per type.

Color coding

Upon request the coupling ring of the plugs and the housings of the receptacles can be delivered in the colors red, green, blue, yellow and grey.
Min order quantity = 250 pcs. per type.

Mechanical coding





Achieved with special coding pins which are inserted into contact cavities.
Min. order quantity = 250 pcs. per type.

Crimp version

Order numbers do not include crimp contacts. Please order separately (see page 33/34).
Crimp contact for higher currents are available upon request.

Crimp tooling



Ask for our catalog "Tools"

Testhouse		Characteristics	Approval No.
VDE		3+PE, 400 V, 16 A 6+PE, 250 V, 10 A	1781 1780
SEV		3+PE, 400 V, 16 A 6+PE, 250 V, 6 A	00.0394
UL		3+PE, 250 V, 12 A 6+PE, 250 V, 8 A	E 63093
CSA		3+PE, 250 V, 12 A 6+PE, 250 V, 8 A 6+PE, 250 V, 15 A	48932
German Llyod		3+PE, 250 V, 16 A 6+PE, 50 V, 8 A	14108 / 84

In general approvals refer to representative versions of the connector series. Extail and specifications of test upon request.

C 16-1

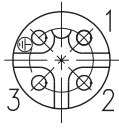
Characteristics

General Characteristics	Standard	Characteristics		
Number of contacts		3 + PE	6 + PE	
				
Electrical Characteristics		screw type	solder type	crimp type
Rated insulation voltage	IEC 60664-1 ¹⁾	400 V	250 V	200 V
Rated impulse withstand voltage	IEC 60664-1 ¹⁾	6000 V	4000 V	
Pollution degree	IEC 60664-1 ¹⁾	3	3	
Installation (overvoltage) category	IEC 60664-1 ¹⁾	III	III	
Material group	IEC 60664-1 ¹⁾	II	II	
Current carrying capacity	IEC 60512-5-2, Test 5b	16 A / + 55 °C	10 A / + 55 °C	13 A / + 55 °C
Insulation resistance	IEC 60512-3-1	≥ 10 ⁸ Ω	≥ 10 ⁸ Ω	
Contact resistance	IEC 60512-2-1	≤ 5 m Ω	≤ 5 m Ω	
Climatical Characteristics				
Climatic category	IEC 60068-1	40 / 100 / 56	40 / 125 / 56	
Operating temperature		-40°C ... +100°C		
Mechanical Characteristics				
IP-degree of protection	IEC 60529	IP 65 / IP 67		
Insertion and withdrawal force	IEC 60512-13-2, Test 13b	≤ 15 N	≤ 30 N	
Mechanical operation	IEC 60512-9-1, Test 9a	≥ 500 mating cycles		
Materials				
Housing material		Polyamid 6.6		
Dielectric material		Polyamid 6.6		
Gasket material		Neoprene		
Contact plating		silver plated / gold plated		
Other Characteristics				
Termination technique		schrauben	löten	crimpen
Wire gauge mm ² / AWG		max. 2,5 mm ²	0,75 mm ²	0,14 - 1,5 mm ²
Flammability	UL 94	V0		
Locking system		round thread DIN 405		
Fire protection	DIN 5510 Part 2 DIN 53438 Part 1-3	S1		

¹⁾ IEC 60664-1 ≙ VDE 0110-1 ≙ DIN EN 60664-1



The stated technical values refer to the use as connector.

If these components are used as plug and socket device a reduced current carrying capacity has to be considered.

C 16-1

Derating curves

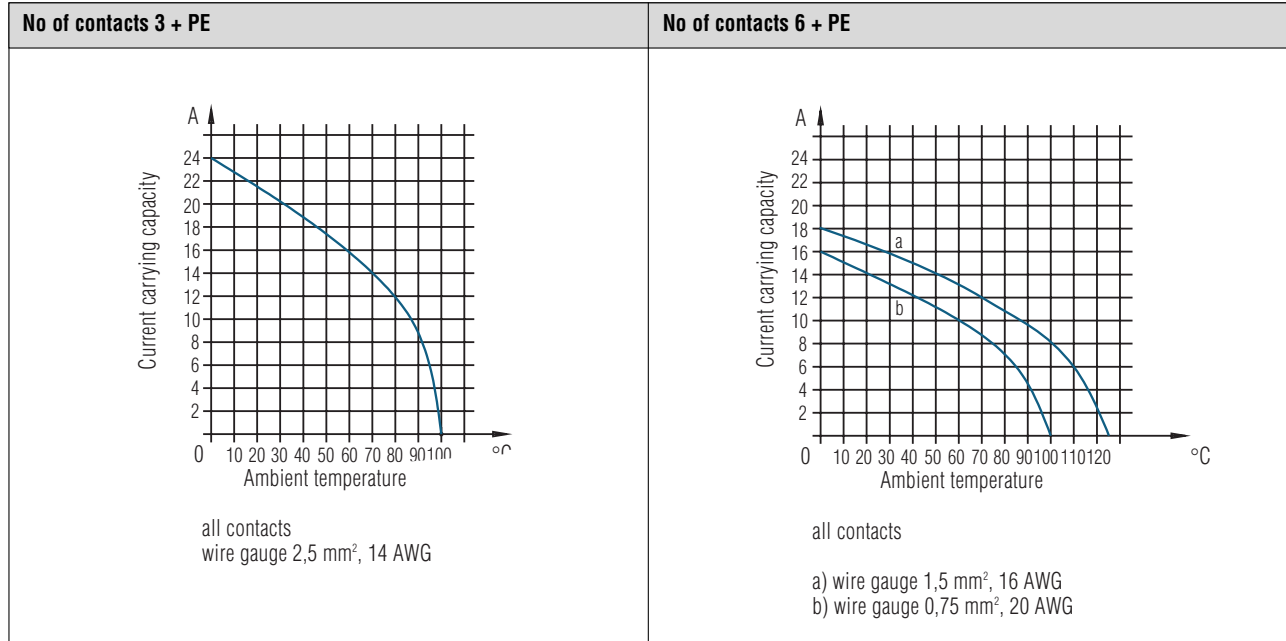

C 16-1

Mounting instructions

Shinning lengths

Screw contacts	7,0+1 mm ¹⁾
Solder contacts	4,0+1 mm
Crimp contacts	0,14 - 0,50 mm ² 3+0,5 mm
	0,50 - 2,50 mm ² 3,5+1 mm

¹⁾end splice recommended

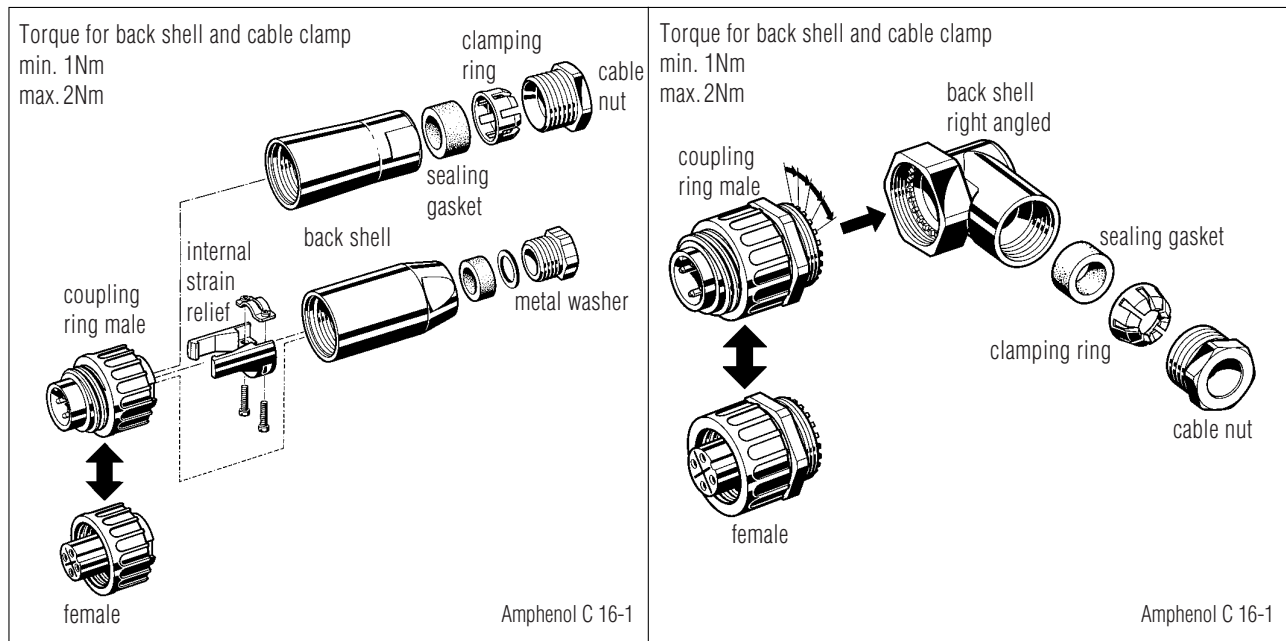

C 16-1

Male cable connectors



Description	Drawing	No. of cont.	Part. no. Cable outlet		
			Ø 8-10	Ø 10-12	Ø 10-12
Male cable connector, 3+PE screw, 6+PE solder termination, with cable clamp or clamping ring		3 + PE	T 3108 001	T 3108 101	T 3108 200 (with clamping ring)
		6 + PE	T 3104 001	T 3104 101	T 3104 200 (with clamping ring)
Male cable connector, 3+PE screw, 6+PE solder termination, without cable clamp		3 + PE	T 3108 000	T 3108 100	–
		6 + PE	T 3104 000	T 3104 100	–
Male cable connector, crimp version without contacts ¹⁾ , with cable clamp or clamping ring		6 + PE	T 3104 501	T 3104 601	T 3104 701 (with clamping ring)
			Cable outlet		
			Ø 6-8	Ø 8-10	
Male cable connector, right-angled, 3+PE screw, 6+PE solder termination, with clamping ring		3 + PE	T 3108 081	T 3108 091	–
		6 + PE	T 3104 081	T 3104 091	–
Male cable connector, right-angled, crimp version, without contacts ¹⁾ , with clamping ring		6 + PE	T 3104 581	T 3104 591	–

¹⁾ Please order crimp contacts separately, see page 33/34, part numbersystem for crimpcontacts see page 35.

C 16-1

Female receptacles

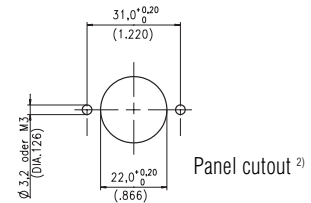

Description	Drawing	No. of cont.	Part. no.
Female receptacle, screw termination		3 + PE	T 3111 000
Female receptacle, solder termination		6 + PE	T 3107 000
Female receptacle, crimp version, without contacts ¹⁾		6 + PE	T 3107 500

¹⁾ Please order crimp contacts separately, see page 33/34, part numbersystem for crimpcontacts see page 35.

²⁾ Mounting hole \varnothing 22 without chamfer, suitable sealing for screws is necessary.

C 16-1

Female cable connectors



Description	Drawing	No. of cont.	Part No. Cable outlet		
			Ø 8-10	Ø 10-12	Ø 10-12
Female cable connector, 3+PE screw, 6+PE solder termination, with cable clamp or clamping ring		3 + PE	T 3109 001	T 3109 101	T 3109 200 (with clamping ring)
		6 + PE	T 3105 001	T 3105 101	T 3105 200 (with clamping ring)
Female cable connector, 3+PE screw, 6+PE solder termination, without cable clamp		3 + PE	T 3109 000	T 3109 100	–
		6 + PE	T 3105 000	T 3105 100	–
Female cable connector, crimp version without contacts ¹⁾ , with cable clamp or clamping ring		6 + PE	T 3105 501	T 3105 601	T 3105 701 (with clamping ring)
				Cable outlet	
				Ø 6-8	Ø 8-10
Female cable connector, right-angled, 3+PE screw, 6+PE solder termination, with clamping ring		3 + PE	T 3109 081	T 3109 091	–
		6 + PE	T 3105 081	T 3105 091	–
Female cable connector, right-angled, crimp version, without contacts ¹⁾ , with clamping ring		6 + PE	T 3105 581	T 3105 591	–

¹⁾ Please order crimp contacts separately, see page 33/34, part numbersystem for crimpcontacts see page 35.

C 16-1

Male receptacles

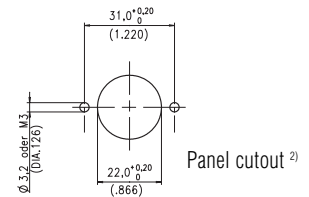





Description	Drawing	No. of cont.	Part No.
Male receptacle, screw termination		3 + PE	T 3110 000
Male receptacle, solder termination		6 + PE	T 3106 000
Male receptacle, crimp version, without contacts ¹⁾		6 + PE	T 3106 500
Male receptacle, straight dip solder pins		3 + PE	T 3110 010 Hole pattern on PCB
Male receptacle, straight dip solder pins		6 + PE	T 3106 010 Hole pattern on PCB

¹⁾ Please order crimp contacts separately, see page 33/34, part numbersystem for crimpcontacts see page 35.

²⁾ Mounting hole \varnothing 22 without chamfer, suitable sealing for screws is necessary.

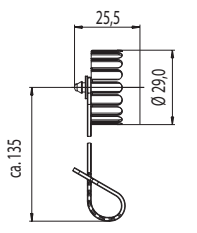
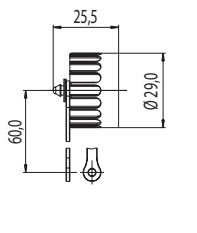
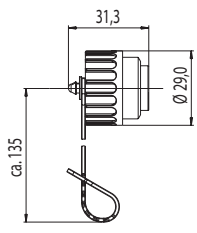
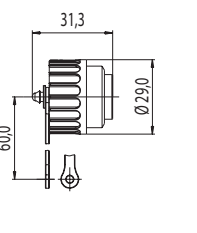
C 16-1

Accessories

Description	Figure	Part No.	Figure	Part No.
Protective cover for male cable connector and male receptacle		for male connector T 6482 201		for male receptacle T 6482 200
Protective cover for female cable connector and female receptacle		for female cable connector T 6483 201		for female receptacle T 6483 200
Backshell, straight version, packaging unit 10 pcs.			cable outlet 8-10 / 0,315-0,394 T 3102 003 7 X	cable outlet 10-12 / 0,394-0,472 T 3102 004 7 X
Back shell, straight version, with clamping ring, Packaging unit 10 pcs.			cable outlet 10-12 / 0,394-0,472 T 3102 005 7 X	
Backshell, right-angled with clamping ring, packaging unit 10 pcs.			cable outlet 8-10 / 0,315-0,394 T 3102 015 7 X	cable outlet 10-12 / 0,394-0,472 T 3102 014 7 X
Cable clamp, packaging unit 10 pcs.			cable clamp diameter Ø 6-12 N 16 110 2000 X	



Product description

The circular connector series C 16-3 has two housing sizes. The connectors are designed to meet the high requirements of industrial applications under harsh environmental conditions. The range includes versions with screw and crimp terminations. A selection of crimp contacts for hand crimp tools and crimp machines enables a reliable termination resulting in qualitative, technical and economical advantages. A broad selection of housing styles are available.

Main features and advantages:

- Circular connectors for power and signal applications with following contact arrangements:
Shell size 1: 8 + PE, 14 + PE, 17 + PE
Shell size 2: 5 + PE, 12 + PE, 14 + PE, 19 + PE
- For applications in machine tools, measurement and control, process technology and medical equipment
- Housing are made from high grade plastic material.
- Vibration safe connection by solid bayonet coupling with lock in position.
- Cable housing straight or right-angled with various cable outlets
- Protection degree IP 65 in mated position.
- Internal cable clamp or clamping ring provides a safe cable restrain.

C 16-3

Product description
Order information
Approvals

Order information

Color coding

Upon request the coupling ring of the plugs and the housings of the receptacles can be delivered in the color red, green, blue, yellow and grey.

Polarization

Depending on the contact arrangements the polarization of this connector series can be varied. The contact inserts can be mounted in alternate positions. The order number in the catalog refers always to position 1. The position of the contact inserts can also be changed by the customer using a disassembly tool (see page 26 and 29) to remove the insert and remount it in the required position (see page 19).

Crimp version

Order numbers do not include crimp contacts. Please order separately (page 33/34).
Crimp contacts for higher currents are available upon request.

Crimp tooling

Ask for our crimp tooling catalogs.

Testhouse	Approvals	Approval No.
VDE		3964
UL		E 63093
CSA		49932-9

In general approvals refer to representative versions of the connector series. Extail and specifications of test upon request.

C 16-3

Coding system

Polarization

Depending on the contact arrangements the polarization of this connector series can be varied. Please take care of the housing and contact insert characteristics.

Shell size 1			Shell size 2		
No of contacts	No of coding possibil.	Position	No of contacts	No of coding possibil.	Position
8 + PE	4	1, 3, 5, 7	5 + PE	6	1, 2, 3, 4, 6, 7
14 + PE	7	1, 2, 3, 4, 5, 6, 7	14 + PE	7	1, 2, 3, 4, 5, 6, 7
17 + PE	6	1, 2, 3, 4, 5, 7	12 + PE	7	1, 2, 3, 4, 5, 6, 7
			19 + PE	6	1, 3, 4, 5, 6, 7

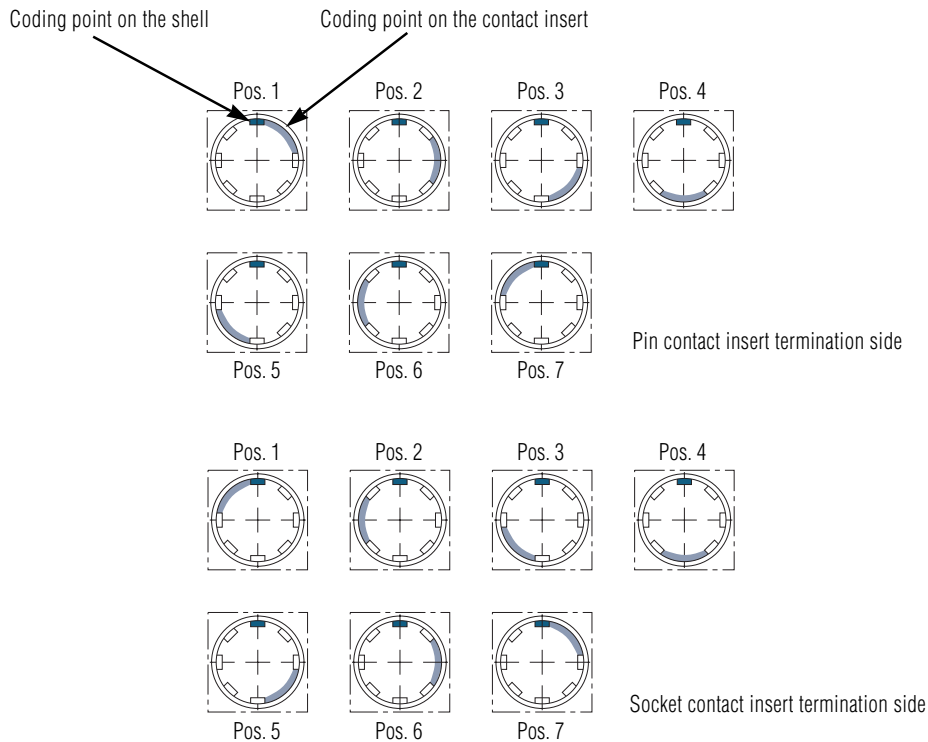



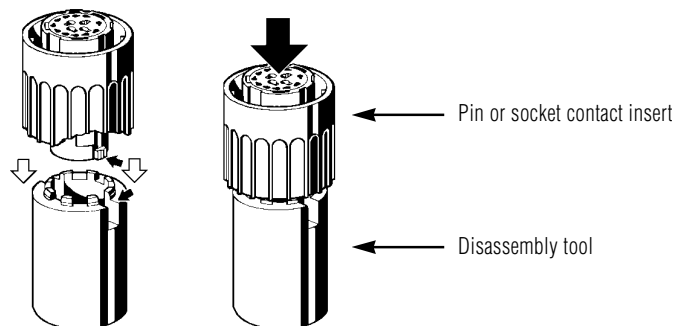

Disassembly of contact inserts with disassembly tool (see page 26 und 29)

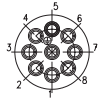

C 16-3

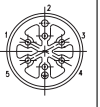
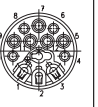
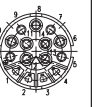
Characteristics

General Characteristics	Standard	Characteristics						
		Shell size 1			Shell size 2			
Number of contacts		8 + PE	14 + PE	17 + PE	5 + PE	12 + PE	14 + PE	19 + PE
								
Electrical Characteristics								
Rated insulation voltage	IEC 60664-1 ¹⁾	400 V	100 V	100 V	400 V	3 x 500 V 9 x 300 V	400 V	250 V
Rated impulse withstand voltage	IEC 60664-1 ¹⁾	6000 V	3000 V	3000 V	6000 V	3 x 6000 V 9 x 4000 V	3110 V	4000 V
Pollution degree	IEC 60664-1 ¹⁾	3	3	3	3	3	3	3
Installation (overvoltage) category	IEC 60664-1 ¹⁾	III	III	III	III	III	III	III
Material group	IEC 60664-1 ¹⁾	II	II	II	II	II	II	II
Current carrying capacity	IEC 60512-5-2, Test 5b	12 A	11 x 6 A 4 x 16 A	6 A	21 A	3 x 21 A 9 x 11 A	4 x 6 A 11 x 12 A	6 A
Insulation resistance	IEC 60512-3-1, Test 3a	≥ 10 ⁸ Ω						
Contact resistance	IEC 60512-2-1, Test 2a	≤ 5 mΩ						
Climatical Characteristics								
Climatic category	IEC 60081-1	40 / 125 / 56			40/100/56	40 / 125 / 56		
Operating temperature		-40°C ... +125°C (5+PE: +100°C)						
Mechanical Characteristics								
IP-degree of protection	IEC 60529	IP 65						
Insertion and withdrawal force	IEC 60512-13-2, Test 13b	≤ 25 N	≤ 30 N	≤ 22 N	≤ 15 N	≤ 25 N	≤ 30 N	≤ 25 N
Mechanical operation	IEC 60512-9-1, Test 9a	≥ 500 mating cycles						
Materials								
Housing material		Polyamid 6.6						
Dielectric material		Polyamid 6.6						
Gasket material		Neoprene						
Contact plating		silver plated / gold plated						
Other Characteristics								
Termination technique		crimp			screw	crimp		
Wire range mm ² / AWG		0,14 - 1,5 mm ²	0,14 - 2,5 mm ²	0,14 - 1,0 mm ²	4 mm ²	0,14 - 2,5 mm ²	0,14 - 2,5 mm ²	0,14 - 1,0 mm ²
Flammability	UL 94	V0						
Locking system		bayonet						
Fire protection	DIN 5510 Part 2 DIN 53438 Part 1-3	S1						

¹⁾ IEC 60664-1 ≙ VDE 0110-1 ≙ DIN EN 60664-1



The stated technical values refer to the use as connector.

If these components are used as plug and socket device a reduced current carrying capacity has to be considered.

C 16-3

Derating curves



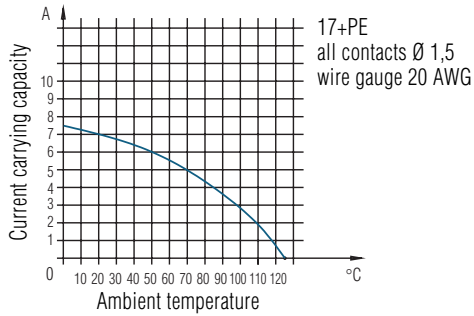
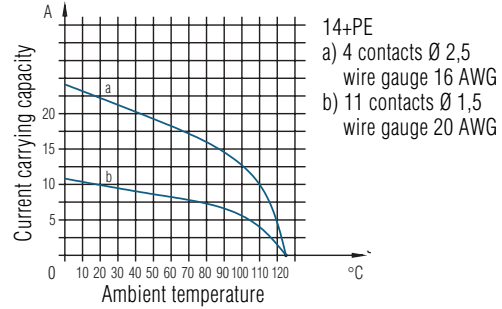
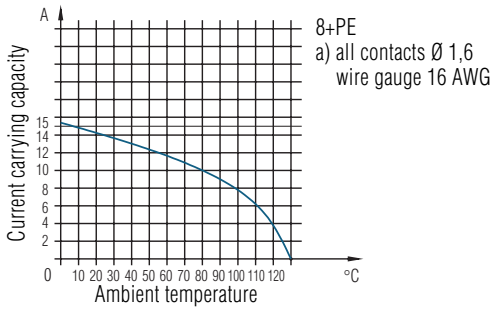



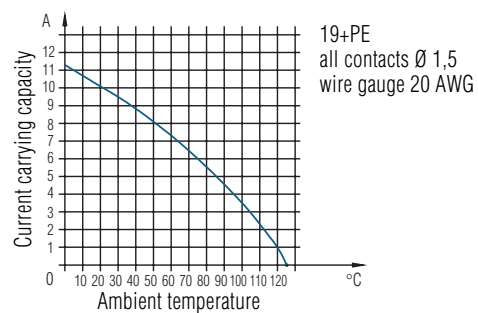
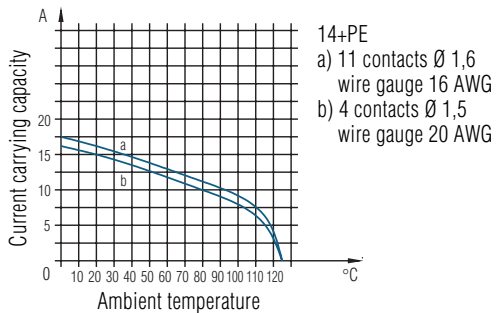
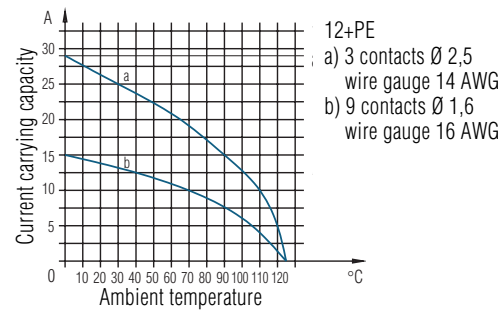
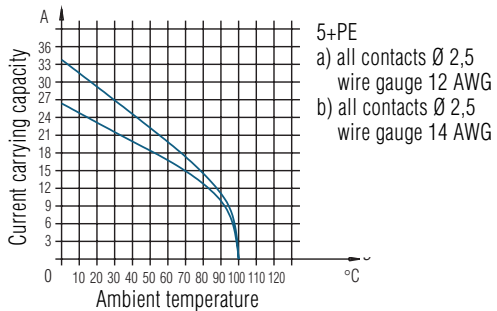

Shell size 1



Shell size 2



C 16-3View of connector style,
Shell size 1 and 2

Identification	Figure	Description	Conn. Style	Page	
				Size 1	Size 2
Male cable connector		Long version with internal cable clamp	I	24	30
		Short version, with clamping ring	H	24	30
		Right-angled, with clamping ring	K	24	30
Female cable connector		Long version with internal cable clamp	E	25	31
		Short version, with clamping ring	D	25	31
		Right-angled, with clamping ring	F	25	31
Female receptacle		Flange mounting, with mounted gasket	G	25	30
		Panel mounting with ring nut, with gasket	N	25	–
Male receptacle		Flange mounting, with mounted gasket	C	26	31

C 16-3

Mounting instruction

Torque for back shell and cable screw
 min. 1 Nm
 max. 2 Nm

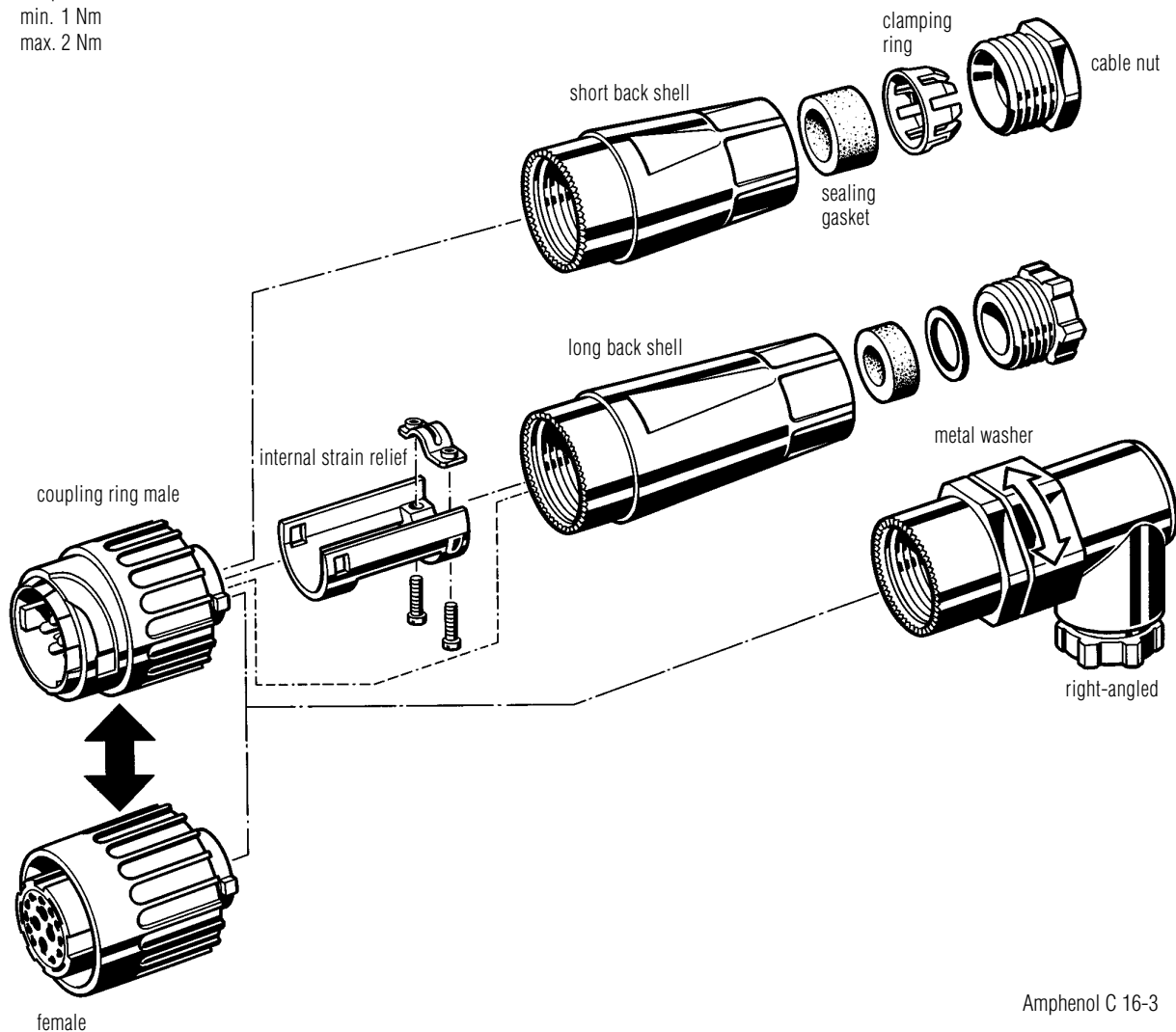

Amphenol C 16-3

Shinning lengths

Screw contacts		7,0+1 mm ¹⁾
Solder contacts		4,0+1 mm
Crimp contacts	0,14 - 0,50 mm ²	3+0,5 mm
	0,50 - 2,50 mm ²	3,5+1 mm

¹⁾end splice recommended

C 16-3

Shell size 1 Male cable connectors



I



H



K

Description	Drawing	No. of cont.	Contacts ²⁾	Part No. Cable outlet	
				Ø 10-12	Ø 12-14
Male cable connector, long, style I with internal cable clamp, without contacts ¹⁾		8 + PE	.N 01 016 00...	C016 10I008 002 1	C016 10I008 003 1
		14 + PE	11 x .N 01 015 00... 4 x .N 01 025 00...	C016 10I014 002 1	C016 10I014 003 1
		17 + PE	.N 01 015 00...	C016 10I017 002 1	C016 10I017 003 1
				Cable outlet	
				Ø 8-10	Ø 10-12
Male cable connector, short, style H with clamping ring, without contacts ¹⁾		8 + PE	.N 01 016 00...	C016 10H008 002 1	C016 10H008 003 1
		14 + PE	11 x .N 01 015 00... 4 x .N 01 025 00...	C016 10H014 002 1	C016 10H014 003 1
		17 + PE	.N 01 015 00...	C016 10H017 002 1	C016 10H017 003 1
Male cable connector, style K with clamping ring, without contacts ¹⁾		8 + PE	.N 01 016 00...	C016 10K008 002 1	C016 10K008 003 1
		14 + PE	11 x .N 01 015 00... 4 x .N 01 025 00...	C016 10K014 002 1	C016 10K014 003 1
		17 + PE	.N 01 015 00...	C016 10K017 002 1	C016 10K017 003 1

¹⁾ Please order crimp contacts separately, see page 33/34. ²⁾ Part No system for crimp contacts, see page 35.

C 16-3

Shell size 1 Female receptacles



G

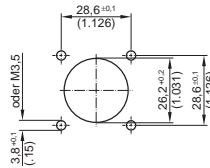

Panel cutout



N

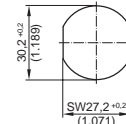

Panel cutout

Identification	Drawing	No. of cont.	Contacts ²⁾	Part No.
Female receptacle, without contacts ¹⁾		8 + PE	.N 02 016 00...	C016 10G008 000 1
		14 + PE	11 x .N 02 015 00... 4 x .N 02 025 00...	C016 10G014 000 1
		17 + PE	.N 02 015 00...	C016 10G017 000 1
Female receptacle, style N, without contacts ¹⁾		8 + PE	.N 02 016 00...	C016 10N008 006 1
		14 + PE	11 x .N 02 015 00... 4 x .N 02 025 00...	C016 10N014 006 1
		17 + PE	.N 02 015 00...	C016 10N017 006 1

C 16-3

Shell size 1 Female cable connectors



E



D



F

Identification	Drawing	No. of cont.	Contacts ²⁾	Part No. Cable outlet	
				Ø 10-12	Ø 12-14
Female cable connector, long, style E with internal cable clamp, without contacts ¹⁾		8 + PE	.N 02 016 00...	C016 10E008 002 1	C016 10E008 003 1
		14 + PE	11 x .N 02 015 00... 4 x .N 02 025 00...	C016 10E014 002 1	C016 10E014 003 1
		17 + PE	.N 02 015 00...	C016 10E017 002 1	C016 10E017 003 1
Female cable connector, short, style D with clamping ring, without contacts ¹⁾		8 + PE	.N 02 016 00...	C016 10D008 002 1	C016 10D008 003 1
		14 + PE	11 x .N 02 015 00... 4 x .N 02 025 00...	C016 10D014 002 1	C016 10D014 003 1
		17 + PE	.N 02 015 00...	C016 10D017 002 1	C016 10D017 003 1
Female cable connector, style F with clamping ring, without contacts ¹⁾		8 + PE	.N 02 016 00...	C016 10F008 002 1	C016 10F008 003 1
		14 + PE	11 x .N 02 015 00... 4 x .N 02 025 00...	C016 10F014 002 1	C016 10F014 003 1
		17 + PE	.N 02 015 0005	C016 10F017 002 1	C016 10F017 003 1

¹⁾ Please order crimp contacts separately, see page 33/34.

²⁾ Part No system for crimp contacts, see page 35.

C 16-3

Shell size 1 Male receptacles



C

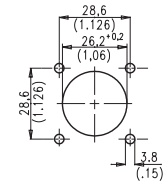

Panel cutout

Identification	Drawing	No. of cont.	Contacts ²⁾	Part No.
Male receptacle, style C, without contacts ¹⁾		8 + PE	.N 01 016 00...	C016 10C008 000 1
		14 + PE	11 x .N 01 015 00... 4 x .N 01 025 00...	C016 10C014 000 1
		17 + PE	.N 01 015 00...	C016 10C017 000 1

C 16-3

Shell size 1 Accessories



Identification	Drawing	Part No.	
		for male cable connector	for female receptacle
Protective cover for male cable connector and male receptacle.		C016 00U000 000 1	C016 00U000 020 1
Protective cover for female cable connector and female receptacle.		C016 00V000 000 1	C016 00V000 020 1
Disassembly tool for pin-and socket inserts		FH 0000-016	

¹⁾ Please order crimp contacts separately, see page 33/34. ²⁾ Part No system for crimp contacts, see page 35.

C 16-3 EMI

Shell size 1
shielded version



The C 16-3 EMI connectors excel by versatile fields of application, especially high mechanical requirements, industrial environments and demands for safe contact.

Main features:

- high attenuation of shielding
- contact inserts suitable for standard and EMI versions
- completely compatible with standard C 16-3, size 1
- same technical characteristics as standard C 16-3

Two versions available:

1. Version with metalized plastic housing accord. VDE 0610. PE wire is connected to cable shield and housing. In case of error the current will be lead directly to the PE wire.
2. Combined version with metalized plastic and two-part metal housing accord. VDE 0113. PE wire is securely and firmly connected with the metal housing.

Crimp version

Order numbers do not include crimp contacts. Please order separately (see page 33/34).

Crimp contact for higher currents are available upon request.

Crimp tooling

Ask for our catalog "Tools".

C 16-3

Shell size 1
C16-3 EMI



Description	Drawing	No. of cont.	Contacts ²⁾	Part No. Cable outlet	
				Ø 10-12	Ø 12-14
Male cable connector, style H, without contacts ¹⁾ , without cable screw, metalized plastic housing		8 + PE	.N 01 016 00...	C016 10H008 012 5	C016 10H008 013 5
		14 + PE	11 x .N 01 015 00... 4 x .N 01 025 00...	C016 10H014 012 5	C016 10H014 013 5
		17 + PE	.N 01 015 00...	C016 10H017 012 5	C016 10H017 013 5
Female cable connector, style D, without contacts ¹⁾ , without cable screw, metalized plastic housing		8 + PE	.N 01 016 00...	C016 10D008 012 5	C016 10D008 013 5
		14 + PE	11 x .N 01 015 00... 4 x .N 01 025 00...	C016 10D014 012 5	C016 10D014 013 5
		17 + PE	.N 01 015 00...	C016 10D017 012 5	C016 10D017 013 5
				Cable outlet Ø 9-11	
Male cable connector, without contacts ¹⁾ , two part metal housing, with PE contact		8 + PE	.N 01 016 00...	C016 10H008 801 3	
		14 + PE	11 x .N 01 015 00... 4 x .N 01 025 00...	C016 10H014 801 3	
		17 + PE	.N 01 015 00...	C016 10H017 801 3	
Female cable connector, without contacts ¹⁾ , two part metal housing, with PE contact		8 + PE	.N 01 016 00...	C016 10D008 801 3	
		14 + PE	11 x .N 01 015 00... 4 x .N 01 025 00...	C016 10D014 801 3	
		17 + PE	.N 01 015 00...	C016 10D017 801 3	

¹⁾ Please order crimp contacts separately, see page 33/34. ²⁾ Part No system for crimp contacts, see page 35.

C 16-3

Shell size 1
C16-3 EMV

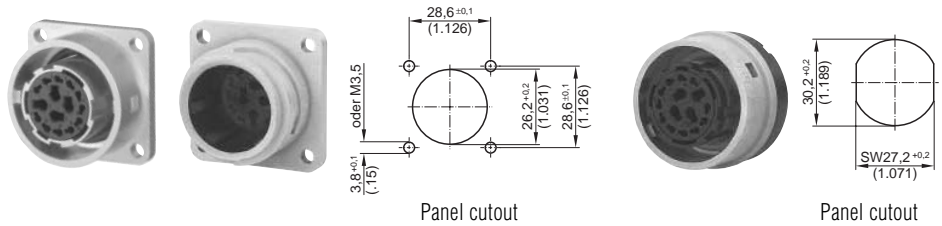

Description	Drawing	No. of cont.	Contacts ²⁾	Part No.
Female receptacle, style G, without contacts ¹⁾		8 + PE	.N 01 016 00...	C016 10G008 000 5
		14 + PE	11 x.N 01 015 00... 4 x.N 01 025 00...	C016 10G014 000 5
		17 + PE	.N 01 015 00...	C016 10G017 000 5
Female receptacle, style N, without contacts ¹⁾		8 + PE	.N 01 016 00...	C016 10N008 000 5
		14 + PE	11 x.N 01 015 00... 4 x.N 01 025 00...	C016 10N014 000 5
		17 + PE	.N 01 015 00...	C016 10N017 000 5
Male receptacle, style C, without contacts ¹⁾		8 + PE	.N 01 016 00...	C016 10C008 000 5
		14 + PE	11 x.N 01 015 00... 4 x.N 01 025 00...	C016 10C014 000 5
		17 + PE	.N 01 015 00...	C016 10C017 000 5

Mounting instruction

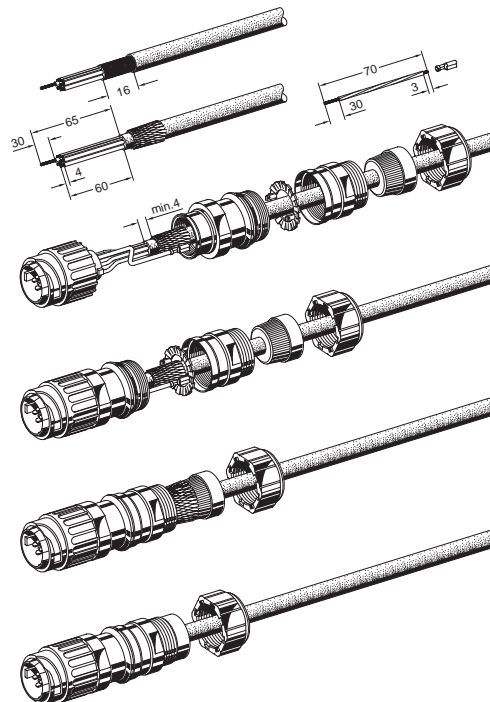

C 16-3

Shell size 2 Male cable connectors



Description	Drawing	No. of cont.	Contacts ²⁾	Part No. Cable outlet		
				Ø 12-14	Ø 14-16	Ø 19-21
Male cable connector, long, style I with internal cable clamp, 5 + PE screw termination, 12 + PE-, 14 + PE and 19 + PE-version without contacts ¹⁾		5 + PE	–	C016 20I005 103 2	C016 20I005 104 2	C016 20I005 105 2
		12 + PE	9 x .N 01 016 00... 4 x .N 01 025 00...	C016 10I012 003 2	C016 10I012 004 2	C016 10I012 005 2
		14 + PE	4 x .N 01 015 00... 11 x .N 01 016 00...	C016 10I014 003 2	C016 10I014 004 2	C016 10I014 005 2
		19 + PE	.N 01 015 000...	C016 10I019 003 2	C016 10I019 004 2	C016 10I019 005 2
				Cable outlet		
				Ø 10-12	Ø 12-14	Ø 14-18
Male cable connector, short, style H with clamping ring, 5 + PE screw termination, 12 + PE-, 14 + PE and 19 + PE-version without contacts ¹⁾		5 + PE	–	C016 20H005 103 2	C016 20H005 104 2	–
		12 + PE	9 x .N 01 016 00... 4 x .N 01 025 00...	C016 10H012 003 2	C016 10H012 004 2	–
		14 + PE	4 x .N 01 015 00... 11 x .N 01 016 00...	C016 10H014 003 2	C016 10H014 004 2	C016 10H014 005 2
		19 + PE	.N 01 015 00...	C016 10H019 003 2	C016 10H019 004 2	–
Male cable connector, style K with clamping ring, 5 + PE screw termination, 12 + PE-, 14 + PE and 19 + PE-version without contacts ¹⁾		5 + PE	–	–	C016 20K005 104 2	–
		12 + PE	9 x .N 01 016 00... 4 x .N 01 025 00...	–	C016 10K012 004 2	–
		14 + PE	4 x .N 01 015 00... 11 x .N 01 016 00...	–	C016 10K014 004 2	–
		19 + PE	.N 01 015 00...	–	C016 10K019 004 2	–

C 16-3

Shell size 2 Female receptacle



G

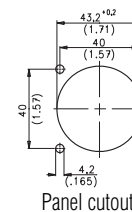

Identification	Drawing	No. of cont.	Contacts ²⁾	Part No.
Female receptacle, style G, 5 + PE screw termination, 12 + PE-, 14 + PE and 19 + PE-version without contacts ¹⁾		5 + PE	–	C016 20G005 100 2
		12 + PE	9 x .N 02 016 00... 4 x .N 02 025 00...	C016 10G012 000 2
		14 + PE	4 x .N 02 015 00... 11 x .N 02 016 00...	C016 10G014 000 2
		19 + PE	.N 02 015 00...	C016 10G019 000 2

¹⁾ Please order crimp contacts separately, see page 33/34. ²⁾ Part No system for crimp contacts, see page 35.

C 16-3

Shell size 2 Female cable connectors



Description	Drawing	No. of cont.	Contacts ²⁾	Part No. Cable outlet		
				Ø 12-14	Ø 14-16	Ø 19-21
Female cable connector, long, style E with internal cable clamp, 5 + PE screw termination, 12 + PE-, 14 + PE and 19 + PE-version without contacts ¹⁾		5 + PE	-	C016 20E005 103 2	C016 20E005 104 2	C016 20E005 105 2
		12 + PE	9 x .N 02 016 00... 4 x .N 02 025 00...	C016 10E012 003 2	C016 10E012 004 2	C016 10E012 005 2
		14 + PE	4 x .N 02 015 00... 11 x .N 02 016 00...	C016 10E014 003 2	C016 10E014 004 2	C016 10E014 005 2
		19 + PE	.N 02 015 00...	C016 10E019 003 2	C016 10E019 004 2	C016 10E019 005 2
				Cable outlet		
				Ø 10-12	Ø 12-14	
Female cable connector, short, style D with clamping ring, 5 + PE screw termination, 12 + PE-, 14 + PE and 19 + PE-version without contacts ¹⁾		5 + PE	-	C016 20D005 103 2	C016 20D005 104 2	-
		12 + PE	9 x .N 02 016 00... 4 x .N 02 025 00...	C016 10D012 003 2	C016 10D012 004 2	-
		14 + PE	4 x .N 02 015 00... 11 x .N 02 016 00...	C016 10D014 003 2	C016 10D014 004 2	-
		19 + PE	.N 01 015 00...	C016 10D019 003 2	C016 10D019 004 2	-
Female cable connector, style F with clamping ring, 5 + PE screw termination, 12 + PE-, 14 + PE and 19 + PE-version without contacts ¹⁾		5 + PE	-	-	C016 20F005 104 2	-
		12 + PE	9 x .N 02 016 00... 4 x .N 02 025 00...	-	C016 10F012 004 2	-
		14 + PE	4 x .N 02 015 00...	-	C016 10F014 004 2	-
		19 + PE	.N 02 015 00...	-	C016 10F019 004 2	-

C 16-3

Shell size 2 Male receptacle



C

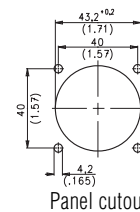

Panel cutout

Description	Drawing	No. of cont.	Contacts ²⁾	Part No.
Male receptacle, style C, 5 + PE screw termination, 12 + PE-, 14 + PE and 19 + PE-version without contacts ¹⁾		5 + PE	-	C016 20C005 100 2
		12 + PE	9 x .N 01 016 00... 4 x .N 01 015 00...	C016 10C012 000 2
		14 + PE	4 x .N 01 015 00... 11 x .N 01 016 00...	C016 10C014 000 2
		19 + PE	.N 01 015 00...	C016 10C019 000 2

¹⁾ Please order crimp contacts separately, see page 33/34. ²⁾ Part No system for crimp contacts, see page 35.

C 16-3

Shell size 2 Accessories



Description	Figure	Part No.	
Protective cover for male cable connector and male receptacle		for male cable connector C016 00U000 010 2	for male receptacle C016 00U000 000 2
Protective cover for female cable connector and female receptacle		for female cable connector C016 00V000 010 2	for female receptacle C016 00V000 000 2
Disassembly tool for pin-and socket inserts		FH 0002-016	

C 16-1 und 16-3

Crimp contacts Pin

Stamped single contacts



Stamped contacts on reel for hand crimping tools



Stamped contacts on reel for crimp machines



Series	Contact Ø in mm	Insulation Ø in mm	No. of cont.	Shell size	Wire gauge in mm ² AWG	Supplied as	pcs.	Part No. Contact plating	
								silver	gold
C 16-1	1,6	1,0 - 2,0	6 + PE	-	0,14 - 0,5 26 - 20	single contact	100	VN 01 016 0011 (1)	VN 01 016 0011 (2)
						contacts on reel	200	ZN 01 016 0011 (1)	ZN 01 016 0011 (2)
						right	2000	HN 01 016 0011 (1)	HN 01 016 0011 (2)
						left	2000	TN 01 016 0011 (1)	TN 01 016 0011 (2)
C 16-1	1,6	1,8 - 2,8	6 + PE	-	0,5 - 1,5 20 - 16	single contact	100	VN 01 016 0004 (1)	VN 01 016 0004 (2)
						contacts on reel	200	ZN 01 016 0004 (1)	ZN 01 016 0004 (2)
						right	2000	HN 01 016 0004 (1)	HN 01 016 0004 (2)
						left	2000	TN 01 016 0004 (1)	TN 01 016 0004 (2)
C 16-3	1,5	1,6 - 2,3	14 + PE	1	0,14 - 0,5 26 - 20	single contact	100	VN 01 015 0046 (1)	VN 01 015 0046 (2)
			17 + PE	1		contacts on reel	200	ZN 01 015 0046 (1)	ZN 01 015 0046 (2)
			14 + PE	2		right	2000	HN 01 015 0046 (1)	HN 01 015 0046 (2)
			19 + PE	2		left	2000	TN 01 015 0046 (1)	TN 01 015 0046 (2)
C 16-3	1,5	1,8 - 2,0	14 + PE	1	0,5 - 1,0 20 - 18	single contact	100	VN 01 015 0047 (1)	VN 01 015 0047 (2)
			17 + PE	1		contacts on reel	200	ZN 01 015 0047 (1)	ZN 01 015 0047 (2)
			14 + PE	2		right	2000	HN 01 015 0047 (1)	HN 01 015 0047 (2)
			19 + PE	2		left	2000	TN 01 015 0047 (1)	TN 01 015 0047 (2)
C 16-3	1,6	1,0 - 2,0	8 + PE	1	0,14 - 0,5 26 - 20	single contact	100	VN 01 016 0003 (1)	VN 01 016 0003 (2)
			12 + PE	2		contacts on reel	200	ZN 01 016 0003 (1)	ZN 01 016 0003 (2)
			14 + PE	2		right	2000	HN 01 016 0003 (1)	HN 01 016 0003 (2)
						left	2000	TN 01 016 0003 (1)	TN 01 016 0003 (2)
C 16-3	1,6	1,8 - 2,8	8 + PE	1	0,5 - 1,5 20 - 16	single contact	100	VN 01 016 0002 (1)	VN 01 016 0002 (2)
			12 + PE	2		contacts on reel	200	ZN 01 016 0002 (1)	ZN 01 016 0002 (2)
			14 + PE	2		right	2000	HN 01 016 0002 (1)	HN 01 016 0002 (2)
						left	2000	TN 01 016 0002 (1)	TN 01 016 0002 (2)
C 16-3	1,6	2,5 - 3,5	8 + PE	1	1,5 - 2,5 16 - 14	single contact	100	VN 01 016 0005 (1)	VN 01 016 0005 (2)
			12 + PE	2		contacts on reel	200	ZN 01 016 0005 (1)	ZN 01 016 0005 (2)
			14 + PE	2		right	2000	HN 01 016 0005 (1)	HN 01 016 0005 (2)
						left	2000	TN 01 016 0005 (1)	TN 01 016 0005 (2)
C 16-3	2,5	1,8 - 2,8	14 + PE	1	0,5 - 1,5 20 - 16	single contact	100	VN 01 025 0001 (101)	VN 01 025 0001 (102)
			12 + PE	2		contacts on reel	200	ZN 01 025 0001 (1)	ZN 01 025 0001 (2)
				right		2000	HN 01 025 0001 (1)	HN 01 025 0001 (2)	
				left		2000	TN 01 025 0001 (1)	TN 01 025 0001 (2)	
		2,5 - 3,5	14 + PE	1	1,5 - 2,5 16 - 14	single contact	100	VN 01 025 0010 (101)	VN 01 025 0010 (102)
	12 + PE		2	contacts on reel		200	ZN 01 025 0010 (1)	ZN 01 025 0010 (2)	
		right	2000	HN 01 025 0010 (1)		HN 01 025 0010 (2)			
		left	2000	TN 01 025 0010 (1)		TN 01 025 0010 (2)			

Single contact in plasticbag stamped contact on reel – HN = feeding right side / TN = feeding left side

C 16-1 und 16-3

Crimp contacts Socket

Stamped single contacts



Stamped contacts on reel for hand crimping tools



Stamped contacts on reel for crimp machines



Series	Contact Ø in mm	Insulation Ø in mm	No. of cont.	Shell size	Wire gauge in mm ² AWG	Supplied as	pcs.	Part No. Contact plating	
								silver	gold
C 16-3	1,5	1,0 - 2,0	14 + PE	1	0,14 - 0,5	single contact	100	VN 02 015 0005 (1)	VN 02 015 0005 (2)
			17 + PE	1	26 - 20	contacts on reel	200	ZN 02 015 0005 (1)	ZN 02 015 0005 (2)
			14 + PE	2		right	2000	HN 02 015 0005 (1)	HN 02 015 0005 (2)
			19 + PE	2		left		TN 02 015 0005 (1)	TN 02 015 0005 (2)
C 16-3	1,5	1,6 - 2,3	14 + PE	1	0,5 - 1,0	single contact	100	VN 02 015 0039 (1)	VN 02 015 0039 (2)
			17 + PE	1	20 - 18	contacts on reel	200	ZN 02 015 0039 (1)	ZN 02 015 0039 (2)
			14 + PE	2		right	2000	HN 02 015 0039 (1)	HN 02 015 0039 (2)
			19 + PE	2		left		TN 02 015 0039 (1)	TN 02 015 0039 (2)
C 16-1 C 16-3	1,6	1,0 - 2,0	6 + PE	–	0,14 - 0,5	single contact	100	VN 02 016 0003 (1)	VN 02 016 0003 (2)
			8 + PE	1	26 - 20	contacts on reel	200	ZN 02 016 0003 (1)	ZN 02 016 0003 (2)
			12 + PE	2		right	2000	HN 02 016 0003 (1)	HN 02 016 0003 (2)
			14 + PE	2		left		TN 02 016 0003 (1)	TN 02 016 0003 (2)
C 16-1 C 16-3	1,6	1,8 - 2,8	6 + PE	–	0,5 - 1,5	single contact	100	VN 02 016 0002 (1)	VN 02 016 0002 (2)
			8 + PE	1	20 - 16	contacts on reel	200	ZN 02 016 0002 (1)	ZN 02 016 0002 (2)
			12 + PE	2		right	2000	HN 02 016 0002 (1)	HN 02 016 0002 (2)
			14 + PE	2		left		TN 02 016 0002 (1)	TN 02 016 0002 (2)
C 16-3	1,6	2,5 - 3,5	6 + PE	–	1,5 - 2,5	single contact	100	VN 02 016 0005 (1)	VN 02 016 0005 (2)
			8 + PE	1	16 - 14	contacts on reel	200	ZN 02 016 0005 (1)	ZN 02 016 0005 (2)
			12 + PE	2		right	2000	HN 02 016 0005 (1)	HN 02 016 0005 (2)
			14 + PE	2		left		TN 02 016 0005 (1)	TN 02 016 0005 (2)
C 16-3	2,5	1,8 - 2,8	14 + PE	1	0,5 - 1,5	single contact	100	VN 02 025 0001 (101)	VN 02 025 0001 (102)
			12 + PE	2	20 - 16	contacts on reel	200	ZN 02 025 0001 (1)	ZN 02 025 0001 (2)
			14 + PE	2		right	2000	HN 02 025 0001 (1)	HN 02 025 0001 (2)
						left		TN 02 025 0001 (1)	TN 02 025 0001 (2)
C 16-3	2,5	2,5 - 3,5	14 + PE	1	1,5 - 2,5	single contact	100	VN 02 025 0010 (101)	VN 02 025 0010 (102)
			12 + PE	2	16 - 14	contacts on reel	200	ZN 02 025 0010 (1)	ZN 02 025 0010 (2)
			14 + PE	2		right	2000	HN 02 025 0010 (1)	HN 02 025 0010 (2)
						left		TN 02 025 0010 (1)	TN 02 025 0010 (2)

Single contact in plasticbag stamped contact on reel – HN = feeding right side / TN = feeding left side

Part No. system for crimp contacts

VN 01 016 0001 **(1)**
1) 2) 3) 4) 5)

- 1) supplied as: VN = single contact 100 pcs.

 ZN = contacts on reel 100, 200 or 400 contacts

 HN = Contacts on reel with 2000 contacts for Acrimat FD (contact feeding right hand side)

 TN = Contacts on reel with 2000 contacts for Acrimat II + III (contact feeding left hand side)
- 2) Type of contact: 01 = male contact
 02 = female contacts
- 3) Contact pin dia.: e. g. 016 $\hat{=}$ 1,6 mm
- 4) Index of version (wire gauge)
- 5) Plating: (1) = silver plated
 (2) = gold plated
 (4) = gold plated for high performance

Summary of Part No.

Part No.	Page	Part No.	Page	Part No.	Page	Part No.	Page
C016 00U000 000 1	26	C016 10E012 004 2	31	C016 10H014 004 2	30	C016 20C005 100 2	31
C016 00U000 000 2	32	C016 10E012 005 2	31	C016 10H014 005 2	30	C016 20D005 103 2	31
C016 00U000 010 2	32	C016 10E014 002 1	25	C016 10H014 012 5	28	C016 20D005 104 2	31
C016 00U000 020 1	26	C016 10E014 003 1	25	C016 10H014 013 5	28	C016 20E005 103 2	31
C016 00V000 000 1	26	C016 10E014 003 2	31	C016 10H017 002 1	24	C016 20E005 104 2	31
C016 00V000 000 2	32	C016 10E014 004 2	31	C016 10H017 012 5	28	C016 20E005 105 2	31
C016 00V000 010 2	32	C016 10E014 005 2	31	C016 10H017 013 5	28	C016 20F005 104 2	31
C016 00V000 020 1	26	C016 10E017 002 1	25	C016 10H017 801 3	28	C016 20G005 100 2	30
C016 10C008 000 1	26	C016 10E017 003 1	25	C016 10H019 003 2	30	C016 20H005 103 2	30
C016 10C008 000 5	29	C016 10E019 003 2	31	C016 10H019 004 2	30	C016 20H005 104 2	30
C016 10C012 000 2	31	C016 10E019 004 2	31	C016 10H07 003 1	24	C016 20I005 103 2	30
C016 10C014 000 1	26	C016 10E019 005 2	31	C016 10I008 002 1	24	C016 20I005 104 2	30
C016 10C014 000 2	31	C016 10F008 002 1	25	C016 10I008 003 1	24	C016 20I005 105 2	30
C016 10C014 000 5	29	C016 10F008 003 1	25	C016 10I012 003 2	30	C016 20K005 104 2	30
C016 10C017 000 1	26	C016 10F012 004 2	31	C016 10I012 004 2	30	FH 0000-016	26
C016 10C017 000 5	29	C016 10F014 002 1	25	C016 10I012 005 2	30	FH 0002-016	32
C016 10C019 000 2	31	C016 10F014 003 1	25	C016 10I014 002 1	24	HN 01 015 0046 (1)	33
C016 10D008 002 1	25	C016 10F014 004 2	31	C016 10I014 003 1	24	HN 01 015 0046 (2)	33
C016 10D008 003 1	25	C016 10F017 002 1	25	C016 10I014 003 2	30	HN 01 015 0047 (1)	33
C016 10D008 012 5	28	C016 10F017 003 1	25	C016 10I014 004 2	30	HN 01 015 0047 (2)	33
C016 10D008 013 5	28	C016 10F019 004 2	31	C016 10I014 005 2	30	HN 01 016 0002 (1)	33
C016 10D008 801 3	28	C016 10G008 000 1	25	C016 10I017 002 1	24	HN 01 016 0002 (2)	33
C016 10D012 003 2	31	C016 10G008 000 5	29	C016 10I017 003 1	24	HN 01 016 0003 (1)	33
C016 10D012 004 2	31	C016 10G012 000 2	30	C016 10I019 003 2	30	HN 01 016 0003 (2)	33
C016 10D014 002 1	25	C016 10G014 000 1	25	C016 10I019 004 2	30	HN 01 016 0004 (1)	33
C016 10D014 801 3	28	C016 10G014 000 2	30	C016 10I019 005 2	30	HN 01 016 0004 (2)	33
C016 10D014 003 1	25	C016 10G014 000 5	29	C016 10K008 002 1	24	HN 01 016 0005 (1)	33
C016 10D014 003 2	31	C016 10G017 000 1	25	C016 10K008 003 1	24	HN 01 016 0005 (2)	33
C016 10D014 004 2	31	C016 10G017 000 5	29	C016 10K012 004 2	30	HN 01 016 0011 (1)	33
C016 10D014 012 5	28	C016 10G019 000 2	30	C016 10K014 002 1	24	HN 01 016 0011 (2)	33
C016 10D014 013 5	28	C016 10H008 002 1	24	C016 10K014 003 1	24	HN 01 025 0001 (1)	33
C016 10D017 002 1	25	C016 10H008 801 3	28	C016 10K014 004 2	30	HN 01 025 0001 (2)	33
C016 10D017 801 3	28	C016 10H008 003 1	24	C016 10K017 002 1	24	HN 01 025 0010 (1)	33
C016 10D017 003 1	25	C016 10H008 012 5	28	C016 10K017 003 1	24	HN 01 025 0010 (2)	33
C016 10D017 012 5	28	C016 10H008 013 5	28	C016 10K019 004 2	30	HN 02 015 0005 (1)	34
C016 10D017 013 5	28	C016 10H012 003 2	30	C016 10N008 000 5	29	HN 02 015 0005 (2)	34
C016 10D019 003 2	31	C016 10H012 004 2	30	C016 10N008 006 1	25	HN 02 015 0039 (1)	34
C016 10D019 004 2	31	C016 10H014 002 1	24	C016 10N014 000 5	29	HN 02 015 0039 (2)	34
C016 10E008 002 1	25	C016 10H014 801 3	28	C016 10N014 006 1	25	HN 02 016 0002 (1)	34
C016 10E008 003 1	25	C016 10H014 003 1	24	C016 10N017 000 5	29	HN 02 016 0002 (2)	34
C016 10E012 003 2	31	C016 10H014 003 2	30	C016 10N017 006 1	25	HN 02 016 0003 (1)	34

Summary of Part No.

Part No.	Page	Part No.	Page	Part No.	Page	Part No.	Page
HN 02 016 0003 (2)	34	T 3107 500	13	TN 02 015 0005 (2)	34	VN 02 025 0001 (101)	34
HN 02 016 0005 (1)	34	T 3108 000	12	TN 02 015 0039 (1)	34	VN 02 025 0001 (102)	34
HN 02 016 0005 (2)	34	T 3108 001	12	TN 02 015 0039 (2)	34	VN 02 025 0010 (101)	34
HN 02 025 0001 (1)	34	T 3108 081	12	TN 02 016 0002 (1)	34	VN 02 025 0010 (102)	34
HN 02 025 0001 (2)	34	T 3108 091	12	TN 02 016 0002 (2)	34	ZN 01 015 0046 (1)	33
HN 02 025 0010 (1)	34	T 3108 100	12	TN 02 016 0003 (1)	34	ZN 01 015 0046 (2)	33
HN 02 025 0010 (2)	34	T 3108 101	12	TN 02 016 0003 (2)	34	ZN 01 015 0047 (1)	33
N 16 110 2000 X	16	T 3108 200	12	TN 02 016 0005 (1)	34	ZN 01 015 0047 (2)	33
T 3102 003 7 X	16	T 3109 000	14	TN 02 016 0005 (2)	34	ZN 01 016 0002 (1)	33
T 3102 004 7 X	16	T 3109 001	14	TN 02 025 0001 (1)	34	ZN 01 016 0002 (2)	33
T 3102 005 7 X	16	T 3109 081	14	TN 02 025 0001 (2)	34	ZN 01 016 0003 (1)	33
T 3102 014 7 X	16	T 3109 091	14	TN 02 025 0010 (1)	34	ZN 01 016 0003 (2)	33
T 3102 015 7 X	16	T 3109 100	14	TN 02 025 0010 (2)	34	ZN 01 016 0004 (1)	33
T 3104 000	12	T 3109 101	14	VN 01 015 0046 (1)	33	ZN 01 016 0004 (2)	33
T 3104 001	12	T 3109 200	14	VN 01 015 0046 (2)	33	ZN 01 016 0005 (1)	33
T 3104 081	12	T 3110 000	15	VN 01 015 0047 (1)	33	ZN 01 016 0005 (2)	33
T 3104 091	12	T 3110 010	15	VN 01 015 0047 (2)	33	ZN 01 016 0011 (1)	33
T 3104 100	12	T 3111 000	13	VN 01 016 0002 (1)	33	ZN 01 016 0011 (2)	33
T 3104 101	12	T 6482 200	16	VN 01 016 0002 (2)	33	ZN 01 025 0001 (1)	33
T 3104 200	12	T 6482 201	16	VN 01 016 0003 (1)	33	ZN 01 025 0001 (2)	33
T 3104 501	12	T 6483 200	16	VN 01 016 0003 (2)	33	ZN 01 025 0010 (1)	33
T 3104 581	12	T 6483 201	16	VN 01 016 0004 (1)	33	ZN 01 025 0010 (2)	33
T 3104 591	12	TN 01 015 0046 (1)	33	VN 01 016 0004 (2)	33	ZN 02 015 0005 (1)	34
T 3104 601	12	TN 01 015 0046 (2)	33	VN 01 016 0005 (1)	33	ZN 02 015 0005 (2)	34
T 3104 701	12	TN 01 015 0047 (1)	33	VN 01 016 0005 (2)	33	ZN 02 015 0039 (1)	34
T 3105 000	14	TN 01 015 0047 (2)	33	VN 01 016 0011 (1)	33	ZN 02 015 0039 (2)	34
T 3105 001	14	TN 01 016 0002 (1)	33	VN 01 016 0011 (2)	33	ZN 02 016 0002 (1)	34
T 3105 081	14	TN 01 016 0002 (2)	33	VN 01 025 0001 (101)	33	ZN 02 016 0002 (2)	34
T 3105 091	14	TN 01 016 0003 (1)	33	VN 01 025 0001 (102)	33	ZN 02 016 0003 (1)	34
T 3105 100	14	TN 01 016 0003 (2)	33	VN 01 025 0010 (101)	33	ZN 02 016 0003 (2)	34
T 3105 101	14	TN 01 016 0004 (1)	33	VN 01 025 0010 (102)	33	ZN 02 016 0005 (1)	34
T 3105 200	14	TN 01 016 0004 (2)	33	VN 02 015 0005 (1)	34	ZN 02 016 0005 (2)	34
T 3105 501	14	TN 01 016 0005 (1)	33	VN 02 015 0005 (2)	34	ZN 02 025 0001 (1)	34
T 3105 581	14	TN 01 016 0005 (2)	33	VN 02 015 0039 (1)	34	ZN 02 025 0001 (2)	34
T 3105 591	14	TN 01 016 0011 (1)	33	VN 02 015 0039 (2)	34	ZN 02 025 0010 (1)	34
T 3105 601	14	TN 01 016 0011 (2)	33	VN 02 016 0002 (1)	34	ZN 02 025 0010 (2)	34
T 3105 701	14	TN 01 025 0001 (1)	33	VN 02 016 0002 (2)	34		
T 3106 000	15	TN 01 025 0001 (2)	33	VN 02 016 0003 (1)	34		
T 3106 010	15	TN 01 025 0010 (1)	33	VN 02 016 0003 (2)	34		
T 3106 500	15	TN 01 025 0010 (2)	33	VN 02 016 0005 (1)	34		
T 3107 000	13	TN 02 015 0005 (1)	34	VN 02 016 0005 (2)	34		

International

Argentina

Amphenol Argentina
Av. Callao 930
2nd Floor Office B "Plaza"
C 1023 AAP Buenos Aires
Phone +54 / 11 / 48 15 68 86
Fax +54 / 11 / 48 14 57 79

Australia

Amphenol Australia Ltd.
2 Fiveways Blvd
Keysborough
Victoria 31 73
Phone +61 / 3 / 8796 / 8888
Fax +61 / 3 / 8796 / 8801

Brasilia

Amphenol do Brasil Ltda.
Rua Diogo Moreira 132, 20th Floor
CEP 05423-010 Sao Paulo SP
Phone +55 / 11 / 3815.1003
Fax +55 / 11 / 3815.1629

France

Amphenol Socapex S.A.S.
Mil-Aero Business Unit
948, Promenade de l'Arve
B.P. 29
74311 Thyez Cedex
Phone +33 / 4 / 5089-2800
Fax +33 / 4 / 5096-1941

Great Britain

Pyle-National
A division of Amphenol Ltd.
Unit D1, Crossgate Drive
Queens Drive
Industrial Estate
Nottingham, NG2 1LW
Phone: +44 / 115 / 986 6200
Fax +44 / 115 / 986 6212

Hongkong

Amphenol East Asia Limited
26/F Railway Plaza
39 Chatham Road South
Tsimshatsui, Kowloon
Phone +8 52 / 26 99 / 26 63
Fax +8 52 / 26 88 / 09 74

India

Amphetrinx Limited
Plot No. 105 Bhosari Industrial Area
Pune - 411 026
Phone +91 / 20 / 27 12 14 18
Fax +91 / 20 / 27 12 05 81

Italy

Amphenol Italia S.p.A.
Via Barbaiana n. 5
I-20020 Lainate (MI)
Phone +39 / 2 / 93 254.1
Fax +39 / 2 / 93 254.445

Japan

Amphenol Japan, K.K.
2-3-27, Kudan Minami
Chiyoda-Ku
Tokyo 102
Phone +81 / 3 / 32 63 / 56 11
Fax +81 / 3 / 52 76 / 70 59

Korea

Amphenol DaeShin Limited
#802 Joong-Dong 1131-5
Wonmi-Ku
Bucheon-City
Kyunggi-Do
Korea 420-020
Phone +82 / 2 / 785 / 1588
Fax +82 / 2 / 589 / 1514

Mexico

Amphenol Mexico
Prolongacion Reforma 61 - 6 B2
Col. Paseo de las Lomas
C.P. 01330 Mexico D.F.
Phone +52 / 55 / 5258.9984
Fax +52 / 55 / 5081.6890

Netherlands

Amphenol Benelux b.v.
Hoofdveste 19
3992 AK Houten
Phone +31 / 30 / 6 35 80 00
Fax +31 / 30 / 6 37 78 99

Peoples Republic of China

Amphenol-Tuchel Electronics GmbH
China Branch
210-1 Taishan Road
Changzhou 213 022
Phone +86 / 05 19 / 5 11 03 01
Fax +86 / 05 19 / 5 11 02 99

Singapore

Amphenol East Asia Limited
Asia Pacific Sales Operation
Singapore Branch
300 Beach Road
#25-07 The Concourse
Singapore 199555
Phone +27 / 11 / 305-95 74
Fax +27 / 11 / 305-95 76

Sweden

Amphenol Scandinavia
Johanneslundsvägen 2
194 61 Upplands Väsby
Phone +46 / 8 / 59 41 04 40
Fax +46 / 8 / 59 03 38 00

Spain

Amphenol Ibérica
C/Comunidad de Madrid, 35-bis
oficina N° 55 "Edificio Burgosol"
E-28230 las Rozas Madrid
Phone +34 / 91 64 07 30 2
Fax +34 / 62 90 54 62 9

South Africa

Amphenol International Ltd
Chislehurst
30 Impala Road
Chislehurst
Sandton, 2146
Phone +27 / 11 / 7 83 95 17
Fax +27 / 11 / 7 83 95 19

Taiwan

Amphenol East Asia Ltd.
Taiwan Branch (H.K.)
116 Zhong Shan Road
Lane 956 Taoyuan City
Taiwan R.O.C. 330
Phone +886 / 3 / 370 / 7855
Fax +886 / 3 / 360 7259

Turkey

Amphenol Turkiye
Ayazaga Mah. Meydan Sk. No. 28
Beybi Giz Plaza, Kat. 26
34396 Maslak/Istanbul
Phone +90 / 0212 / 335 25 01
Fax +90 / 0212 / 335 25 00

USA

Amphenol-Tuchel Electronics
Representative Office
6900 Haggerty Road
Suite 200
Canton, Michigan 48187
Phone +1 / 734 / 451 6400
Fax +1 / 734 / 451 7197

Amphenol Corporation
Corporate Headquarters
358 Hall Avenue
Wallingford, CT 06492
Phone +1 / 2 03 / 2 65 / 89 00
Fax +1 / 2 03 / 2 65 / 86 28

Your engineering sales representatives:

Amphenol

Amphenol-Tuchel Electronics GmbH

August-Haessler-Str. 10 · D-74080 Heilbronn · Germany · Phone +49 (0) 71 31/9 29-0 · Fax +49 (0) 71 31/9 29-486 · www.amphenol.info