

# C 091 D

---

## Main Features

- Precision metal construction.
- Ingress Protection class IP 67.
- Threaded coupling acc. to IEC 130-9.
- Number of contacts are 3 to 8, 12 and 14.
- Internal metal strain relief.
- Complete EMI shielding in the fully mated and locked position (EMI security).
- Male and female cable connectors: solder in 3 to 8, 12, 14 positions; crimp in 3 to 8 positions; cable outlet in PG 7 for diameter of 6 mm; cable outlet in PG 9 for diameter of 8 mm ; straight cable entry; metal coupling nickel plated
- Male and female receptacles for panel mount: front or rear mounting, solder in 3 to 8, 12, 14 positions; crimp in 3 to 8 positions; PCB mounting, vertical, using dip solder termination with multiple tail lengths.
- The connectors are registered under File # E 63 093 UL.



UNDERWRITERS LABORATORIES INC.



# C 091 D

## Characteristics

General Characteristics	Standard	Characteristics									
Number of contacts		3	4	5	5 Stereo	6	7	7	8	12	14
View on termination side of contact insert											
Contact arrangement acc. to DIN		41 524	–	–	41 524	41 322	–	45 329	45 326	–	–
Contact arrangement acc. to IEC		130-9	–	–	130-9	130-9	–	130-9	130-9	–	–
Electrical Characteristics											
Rated voltage	IEC 60664-1	300 V ≈			100V ≈	300 V ≈			150 V ≈		
Rated impulse withstand voltage	IEC 60664-1	1500 V			1200 V	1500 V			1200 V		
Pollution degree	IEC 60664-1	1									
Installation category	IEC 60664-1	I									
Insulation group	IEC 60664-1	3									
Test voltage	IEC 60664-1	980 V ~			670 V ~	980 V ~			670 V ~		
Current rating	IEC 60512-3 Test 5 b	5 A / + 40 °C / + 104 °F								3 A / + 40 °C / + 104 °F	
Insulation resistance	IEC 60512-2 Test 3 a	> 10 <sup>12</sup> Ω									
Contact resistance	IEC 60512-2 Test 2 a	< 5 m Ω									
Climatical Characteristics											
Climatic category	IEC 60668-1	40 / 85 / 56									
Temperature range	IEC 60668-1	- 40 °C ... + 85 °C / - 40 °F ... + 185 °F									
Mechanical Characteristics											
IP-degree	IEC 60529	IP 67, cable diameter PG 7: .137 - .236, PG 9: .236 - .314									
Insertion and withdrawal forces	IEC 60512-7 Test 13 b	25 N 90.oz	30 N 110.oz	35 N 125.oz	50 N 180.oz	55 N 200.oz	60 N 220.oz	60 N 220.oz	50 N 180.oz		
Mechanical operation	IEC 60512-5 Test 9 a	Silver ≥ 500 mating cycles Gold ≥ 1000 mating cycles									
Materials											
Housing material		die cast, nickel plated									
Dielectric material		thermoplastic									
Sealing material		neoprene									
Contact plating		silver plated / gold plated *									
Further Characteristics											
Termination technique		solder, crimp								solder	
Wire gauge		solder ≤ 0,5 mm <sup>2</sup> (20-26 AWG), crimp 0,14 – 1,0 mm <sup>2</sup> (26-18 AWG)								≤ 0,25 mm <sup>2</sup> /24 AWG	
Flammability		UL 94 V0									
Locking system	IEC 130-9	metal screw coupling									

### Characteristics

Do not connect or disconnect under load. Metal housing parts shall be securely incorporated to protected ground.

#### \* Remark for gold plated contacts

To avoid brittle intermetallic connections gold-plated soldering terminals must be pre-tinned before soldering.

**Amphenol**

# C 091 D

## Male cable connector

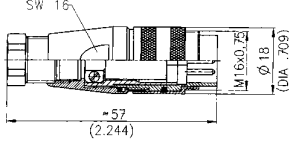
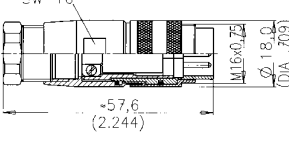

Description	Drawing	No. of cont.	Part Number solder termination		Part Number Crimp termination <sup>1)</sup>		
			Contact plating silver	Contact plating gold <sup>2)</sup>			
Male cable connector. Max. cable outlet 6 mm, termination: solder or crimp, contact plating: silver or gold.	 <p>PG 7</p>	3 DIN	C091 31H003 100 2	–	C091 11H003 000 2		
		4 IEC	C091 31H004 100 2	–	C091 11H004 000 2		
		5 DIN	C091 31H005 100 2	–	C091 11H005 000 2		
		5S DIN	C091 31H105 100 2	–	C091 11H105 000 2		
		6 DIN	C091 31H006 100 2	–	C091 11H006 000 2		
		7	C091 31H007 100 2	–	C091 11H007 000 2		
		7 DIN	C091 31H107 100 2	–	C091 11H107 000 2		
		8 DIN	C091 31H008 100 2	–	C091 11H008 000 2		
		12	C091 31H012 100 2	C091 31H012 200 2	–		
		14	C091 31H014 100 2	C091 31H014 200 2	–		
		Male cable connector. Max. cable outlet 8 mm, termination: solder or crimp, contact plating: silver or gold.	 <p>PG 9</p>	3 DIN	C091 31H003 101 2	–	C091 11H003 001 2
				4 IEC	C091 31H004 101 2	–	C091 11H004 001 2
				5 DIN	C091 31H005 101 2	–	C091 11H005 001 2
				5S DIN	C091 31H105 101 2	–	C091 11H105 001 2
6 DIN	C091 31H006 101 2			–	C091 11H006 001 2		
7	C091 31H007 101 2			–	C091 11H007 001 2		
7 DIN	C091 31H107 101 2			–	C091 11H107 001 2		
8 DIN	C091 31H008 101 2			–	C091 11H008 001 2		
12	–			C091 31H012 201 2	–		
14	–			C091 31H014 201 2	–		

<sup>1)</sup> Please order crimp contacts separately, see page 46 <sup>2)</sup> see remark page 39

### Assembling instruction

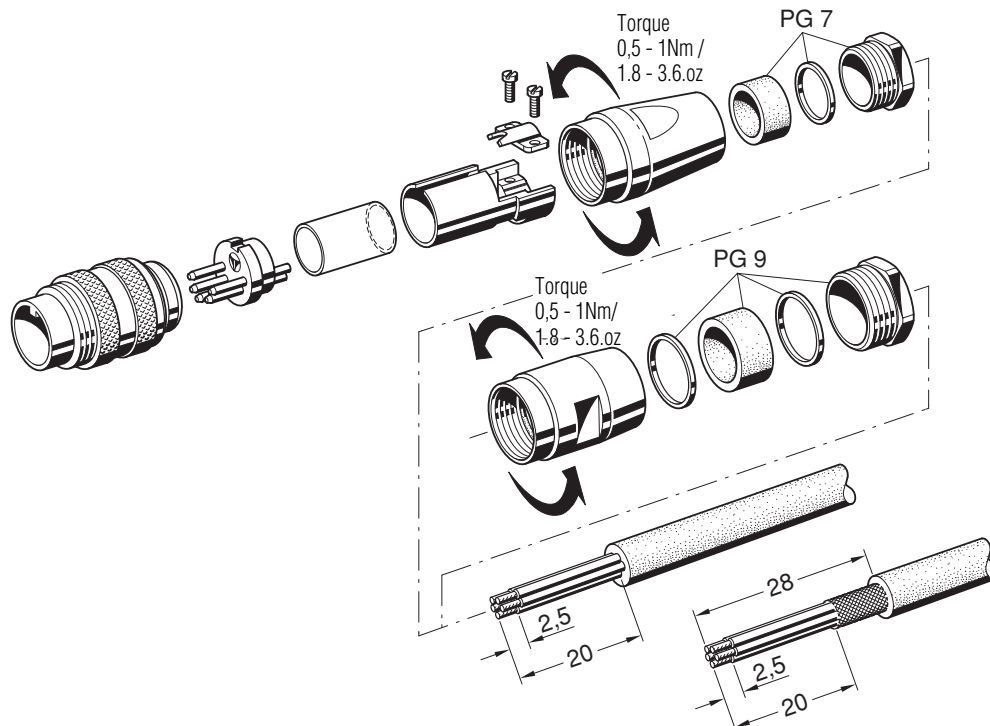

# C 091 D

## Female cable connector

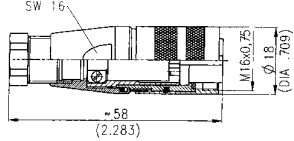
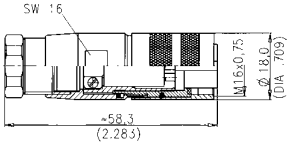

Description	Drawing	No. of cont.	Part Number solder termination		Part Number Crimp termination <sup>1)</sup>		
			Contact plating silver	Contact plating gold <sup>2)</sup>			
Female cable connector. Max. cable outlet 6 mm, termination: solder or crimp, contact plating: silver or gold.	 PG 7	3 DIN	C091 31D003 100 2	–	C091 11D003 000 2		
		4 IEC	C091 31D004 100 2	–	C091 11D004 000 2		
		5 DIN	C091 31D005 100 2	–	C091 11D005 000 2		
		5S DIN	C091 31D105 100 2	–	C091 11D105 000 2		
		6 DIN	C091 31D006 100 2	–	C091 11D006 000 2		
		7	C091 31D007 100 2	–	C091 11D007 000 2		
		7 DIN	C091 31D107 100 2	–	C091 11D107 000 2		
		8 DIN	C091 31D008 100 2	–	C091 11D008 000 2		
		12	C091 31D012 100 2	C091 31D012 200 2	–		
		14	C091 31D014 100 2	C091 31D014 200 2	–		
		Female cable connector. Max. cable outlet 8 mm, termination: solder or crimp, contact plating: silver or gold.	 PG 9	3 DIN	C091 31D003 101 2	–	C091 11D003 001 2
				4 IEC	C091 31D004 101 2	–	C091 11D004 001 2
				5 DIN	C091 31D005 101 2	–	C091 11D005 001 2
				5S DIN	C091 31D105 101 2	–	C091 11D105 001 2
6 DIN	C091 31D006 101 2			–	C091 11D006 001 2		
7	C091 31D007 101 2			–	C091 11D007 001 2		
7 DIN	C091 31D107 101 2			–	C091 11D107 001 2		
8 DIN	C091 31D008 101 2			–	C091 11D008 001 2		
12	–			C091 31D012 201 2	–		
14	–			C091 31D014 201 2	–		

<sup>1)</sup> Please order crimp contacts separately, see page 46 <sup>2)</sup> see remark page 39

### Assembling instruction

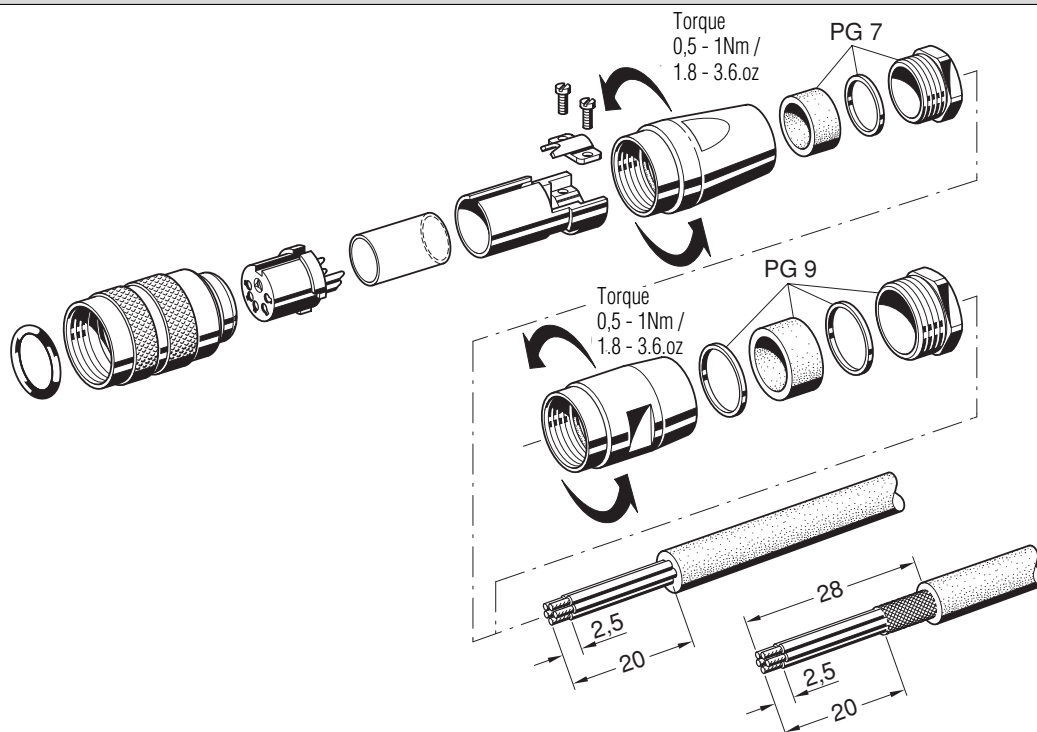

# C 091 D

Female receptacle  
for front mounting

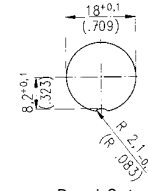
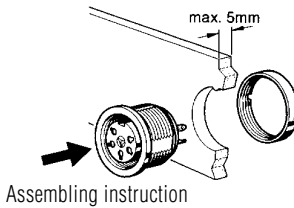

Assembling instruction

Panel Cutout

Description	Drawing	No. of cont.	Part Number solder termination		Part Number Crimp termination <sup>1)</sup>		
			Contact plating silver	Contact plating gold <sup>2)</sup>			
Female receptacle, termination: solder or crimp, contact plating: silver or gold, panel mounting with ring nut, sealing with O-Ring, solder area: tin plated.		3 DIN	C091 31N003 100 2	–	C091 11N003 000 2		
		4 IEC	C091 31N004 100 2	–	C091 11N004 000 2		
		5 DIN	C091 31N005 100 2	–	C091 11N005 000 2		
		5S DIN	C091 31N105 100 2	–	C091 11N105 000 2		
		6 DIN	C091 31N006 100 2	–	C091 11N006 000 2		
		7	C091 31N007 100 2	–	C091 11N007 000 2		
		7 DIN	C091 31N107 100 2 <sup>4)</sup>	–	C091 11N107 000 2		
		8 DIN	C091 31N008 100 2	–	C091 11N008 000 2		
		12	–	C091 31N012 200 2 <sup>4)</sup>	–		
		14	–	C091 31N014 200 2 <sup>4)</sup>	–		
		Female receptacle, termination: straight dip solder, contact plating: silver or gold, pin length 15 mm (12 + 14 contacts: 18 mm) from flange, panel mounting with ring nut, sealing with O-Ring, solder area: tin plated.		3 DIN	C091 61N003 110 2	–	–
				4 IEC	C091 61N004 110 2	–	–
				5 DIN	C091 61N005 110 2	–	–
				5S DIN	C091 61N105 110 2	–	–
6 DIN	C091 61N006 110 2			–	–		
7	C091 61N007 110 2			–	–		
7 DIN	C091 61N107 110 2			–	–		
8 DIN	C091 61N008 110 2			–	–		
12	–			C091 61N012 210 2	–		
14	–			C091 61N014 210 2	–		
Female receptacle, termination: straight dip solder, contact plating: silver, panel mounting with ring nut, sealing with O-Ring, solder area: tin plated.				3 DIN	C091 61N003 120 2	–	–
				4 IEC	C091 61N004 120 2	–	–
				5 DIN	C091 61N005 120 2	–	–
				5S DIN	C091 61N105 120 2	–	–
		6 DIN	C091 61N006 120 2	–	–		
		7	C091 61N007 120 2	–	–		
		7 DIN	C091 61N107 120 2	–	–		
		8 DIN	C091 61N008 120 2	–	–		
		12	–	–	–		
		14	–	–	–		
		Female receptacle, termination: straight dip solder, contact plating: silver, panel mounting with ring nut, sealing with O-Ring, solder area: tin plated.		3 DIN	C091 61N003 130 2	–	–
				4 IEC	C091 61N004 130 2	–	–
				5 DIN	C091 61N005 130 2	–	–
				5S DIN	C091 61N105 130 2	–	–
6 DIN	C091 61N006 130 2			–	–		
7	C091 61N007 130 2			–	–		
7 DIN	C091 61N107 130 2			–	–		
8 DIN	C091 61N008 130 2			–	–		
12	–			–	–		
14	–			–	–		

<sup>1)</sup> Please order crimp contacts separately, see page 46 <sup>2)</sup> see remark page 39

<sup>4)</sup> Available upon request. Min. order qty.100 pcs/type.

# C 091 D

Female receptacle for rear mounting

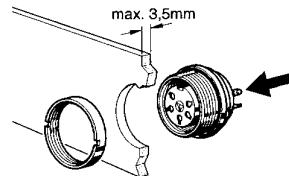

Assembling instruction

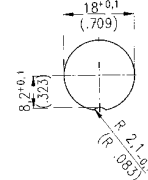

Panel Cutout

Description	Drawing	No. of cont.	Part Number solder termination		Part Number Crimp termination <sup>1)</sup>		
			Contact plating silver	Contact plating gold <sup>2)</sup>			
Female receptacle, termination: solder or crimp, contact plating: silver or gold, panel mounting with ring nut, sealing with O-Ring, solder area: tin plated.		3 DIN	C091 31G003 100 2	–	C091 11G003 000 2 <sup>4)</sup>		
		4 IEC	C091 31G004 100 2	–	C091 11G004 000 2		
		5 DIN	C091 31G005 100 2	–	C091 11G005 000 2 <sup>4)</sup>		
		5S DIN	C091 31G105 100 2	–	C091 11G105 000 2		
		6 DIN	C091 31G006 100 2	–	C091 11G006 000 2 <sup>4)</sup>		
		7	C091 31G007 100 2	–	C091 11G007 000 2 <sup>4)</sup>		
		7 DIN	C091 31G107 100 2	–	C091 11G107 000 2		
		8 DIN	C091 31G008 100 2	–	C091 11G008 000 2		
		12	C091 31G012 100 2	C091 31G012 200 2	–		
		14	C091 31G014 100 2	C091 31G014 200 2	–		
		Female receptacle, termination: straight dip solder, contact plating: silver or gold, pin length 10.5 mm (12 + 14 contacts:13.5 mm) from flange, panel mounting with ring nut, sealing with O-Ring, solder area: tin plated.		3 DIN	C091 61G003 110 2	–	–
				4 IEC	C091 61G004 110 2	–	–
				5 DIN	C091 61G005 110 2	–	–
				5S DIN	C091 61G105 110 2	–	–
6 DIN	C091 61G006 110 2			–	–		
7	C091 61G007 110 2			–	–		
7 DIN	C091 61G107 110 2			–	–		
8 DIN	C091 61G008 110 2			–	–		
12	C091 61G012 110 2			C091 61G012 210 2	–		
14	C091 61G014 110 2			C091 61G014 210 2	–		
Female receptacle, termination: straight dip solder, contact plating: silver, panel mounting with ring nut, sealing with O-Ring, solder area: tin plated.				3 DIN	C091 61G003 120 2	–	–
				4 IEC	C091 61G004 120 2	–	–
				5 DIN	C091 61G005 120 2	–	–
				5S DIN	C091 61G105 120 2	–	–
		6 DIN	C091 61G006 120 2	–	–		
		7	C091 61G007 120 2	–	–		
		7 DIN	C091 61G107 120 2	–	–		
		8 DIN	C091 61G008 120 2	–	–		
		12	–	–	–		
		14	–	–	–		
		Female receptacle, termination: straight dip solder, contact plating: silver, panel mounting with ring nut, sealing with O-Ring, solder area: tin plated.		3 DIN	C091 61G003 130 2	–	–
				4 IEC	C091 61G004 130 2	–	–
				5 DIN	C091 61G005 130 2	–	–
				5S DIN	C091 61G105 130 2	–	–
6 DIN	C091 61G006 130 2			–	–		
7	C091 61G007 130 2			–	–		
7 DIN	C091 61G107 130 2			–	–		
8 DIN	C091 61G008 130 2			–	–		
12	–			–	–		
14	–			–	–		

<sup>1)</sup> Please order crimp contacts separately, see page 46 <sup>2)</sup> see remark page 39

<sup>4)</sup> Available upon request. Min. order qty.100 pcs/type.

## C 091 D

Female receptacle  
for flange mounting

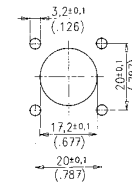

Panel Cutout

Description	Drawing	No. of cont.	Part Number solder termination		Part Number Crimp termination <sup>1)</sup>
			Contact plating silver	Contact plating gold <sup>2)</sup>	
Female receptacle, square flange, termination: solder, contact plating: silver or gold, with sealing gasket.		3 DIN	C091 31T003 100 2	–	–
		4 IEC	C091 31T004 100 2	–	–
		5 DIN	C091 31T005 100 2	–	–
		5S DIN	C091 31T105 100 2	–	–
		6 DIN	C091 31T006 100 2	–	–
		7	C091 31T007 100 2	–	–
		7 DIN	C091 31T107 100 2 <sup>4)</sup>	–	–
		8 DIN	C091 31T008 100 2	–	–
		12	–	C091 31T012 200 2	–
		14	–	C091 31T014 200 2	–

## C 091 D

Male receptacle  
for front mounting

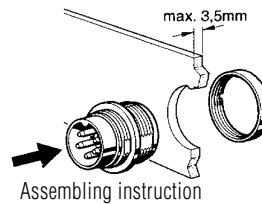

Assembling instruction

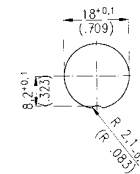

Panel Cutout

Description	Drawing	No. of cont.	Part Number solder termination		Part Number Crimp termination <sup>1)</sup>
			Contact plating silver	Contact plating gold <sup>2)</sup>	
Male receptacle, termination: solder or crimp, contact plating: silver or gold, panel mounting with ring nut, sealing with O-Ring.		3 DIN	C091 31W003 100 2	–	C091 11W003 000 2
		4 IEC	C091 31W004 100 2	–	C091 11W004 000 2
		5 DIN	C091 31W005 100 2	–	C091 11W005 000 2
		5S DIN	C091 31W105 100 2	–	C091 11W105 000 2
		6 DIN	C091 31W006 100 2	–	C091 11W006 000 2
		7	C091 31W007 100 2	–	C091 11W007 000 2
		7 DIN	C091 31W107 100 2	–	C091 11W107 000 2
		8 DIN	C091 31W008 100 2	–	C091 11W008 000 2
		12	–	C091 31W012 200 2	–
		14	–	C091 31W014 200 2	–

<sup>1)</sup> Please order crimp contacts separately, see page 46 <sup>2)</sup> see remark page 39

<sup>4)</sup> Available upon request. Min. order qty.100 pcs/type.



## C 091 D

Male receptacle  
for rear mounting

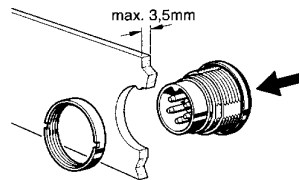

Assembling instruction

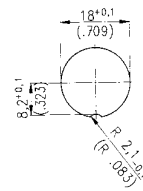

Panel Cutout

Description	Drawing	No. of cont.	Part Number solder termination		Part Number Crimp termination <sup>1)</sup>
			Contact plating silver	Contact plating gold <sup>2)</sup>	
Male receptacle, termination: solder or crimp, contact plating: silver or gold, panel mounting with ring nut, sealing with O-Ring.		3 DIN	C091 31C003 100 2	–	C091 11C003 000 2 <sup>4)</sup>
		4 IEC	C091 31C004 100 2	–	C091 11C004 000 2 <sup>4)</sup>
		5 DIN	C091 31C005 100 2	–	C091 11C005 000 2 <sup>4)</sup>
		5S DIN	C091 31C105 100 2	–	C091 11C105 000 2 <sup>4)</sup>
		6 DIN	C091 31C006 100 2	–	C091 11C006 000 2 <sup>4)</sup>
		7	C091 31C007 100 2	–	C091 11C007 000 2
		7 DIN	C091 31C107 100 2	–	C091 11C107 000 2 <sup>4)</sup>
		8 DIN	C091 31C008 100 2	–	C091 11C008 000 2
		12	–	C091 31C012 200 2	–
		14	–	C091 31C014 200 2	–

## C 091 D

Male receptacle  
for flange mounting

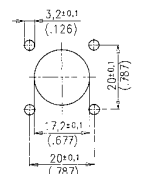

Panel Cutout

Description	Drawing	No. of cont.	Part Number solder termination		Part Number Crimp termination <sup>1)</sup>
			Contact plating silver	Contact plating gold <sup>2)</sup>	
Male receptacle, square flange, termination: solder, contact plating: silver or gold, with sealing gasket.		3 DIN	C091 31S003 100 2	–	–
		4 IEC	C091 31S004 100 2	–	–
		5 DIN	C091 31S005 100 2	–	–
		5S DIN	C091 31S105 100 2	–	–
		6 DIN	C091 31S006 100 2	–	–
		7	C091 31S007 100 2	–	–
		7 DIN	C091 31S107 100 2	–	–
		8 DIN	C091 31S008 100 2	–	–
		12	–	C091 31S012 200 2	–
		14	–	C091 31S014 200 2	–

<sup>1)</sup> Please order crimp contacts separately, see page 46 <sup>2)</sup> see remark page 39

<sup>4)</sup> Available upon request. Min. order qty.100 pcs/type.

# C 091

## Crimp contacts



Pin contact



Socket contact

Typ of Contact	Contact Ø	Wire Gauge	max. Insul. Ø	Supplied as	Pcs.	Part Number	
						silver	gold
Pin contact	1.5 mm	0.14-0.5 mm <sup>2</sup> AWG 26-20	2.0 <sup>+0.2</sup> mm	single contact	100	VN01 015 0005 (1)	VN01 015 0005 (2)
				contacts on reel	200	ZN01 015 0005 (1)	ZN01 015 0005 (2)
					2000	HN01 015 0005 (1)	HN01 015 0005 (2)
		0.5-1.0 mm <sup>2</sup> AWG 20-18	2.0 <sup>+0.2</sup> mm	single contact	100	VN01 015 0039 (1)	VN01 015 0039 (2)
				contacts on reel	200	ZN01 015 0039 (1)	ZN01 015 0039 (2)
					2000	HN01 015 0039 (1)	HN01 015 0039 (2)
Socket contact	1.5 mm	0.14-0.5 mm <sup>2</sup> AWG 26-20	2.0 <sup>+0.2</sup> mm	single contact	100	VN02 015 0005 (1)	VN02 015 0005 (2)
				contacts on reel	200	ZN02 015 0005 (1)	ZN02 015 0005 (2)
					2000	HN02 015 0005 (1)	HN02 015 0005 (2)
		0.5-1.0 mm <sup>2</sup> AWG 20-18	2.0 <sup>+0.2</sup> mm	single contact	100	VN02 015 0039 (1)	VN02 015 0039 (2)
				contacts on reel	200	ZN02 015 0039 (1)	ZN02 015 0039 (2)
					2000	HN02 015 0039 (1)	HN02 015 0039 (2)



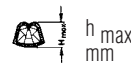

For more information upon crimping tools please contact factory or order our catalogue.

Minimum retention forces according to IEC 352-2							
Wires				Wires			
Wire size		Minimum retention force	Crimp height (average values)	Wire size		Minimum retention force	Crimp height (average values)
mm <sup>2</sup>		N	 h <sub>max</sub> mm	mm <sup>2</sup>	AWG	N	 h <sub>max</sub> mm
0.14 - 0.5 AWG 26-20	0.14	24	0.9 - 1.01	0.14 - 0.5	26	24	0.9 - 1.0
	0.25	42	0.92 - 1.09		24	39	0.92 - 1.02
	0.5	73	0.95 - 1.11 1.3 - 1.39		22	53	0.93 - 1.03
0.5 - 1.5 AWG 20-16	0.75	101	1.34 - 1.4	0.5 - 1.5	20	84	0.95 - 1.10 1.24 - 1.34
	1	135	1.36 - 1.44		18	131	1.32 - 1.42

These min. values are based on the copper wire tensile strength with  $\delta_B \approx 230 \text{ N/mm}^2$ .

# C 091

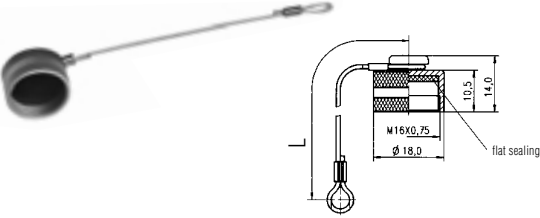
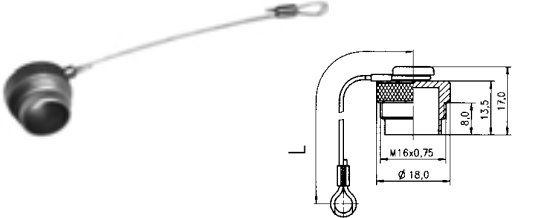
## Accessories

Description	for Series	Drawing	Part Number		
Spanner wrench for receptacles with ring nut.	C 091 A C 091 B C 091 D		N 45 091-000 1		
Spanner wrench for male and female cable connectors.	C 091 A C 091 B C 091 D		FH 0300-091		
Protective cover for male cable connectors and male receptacles.	C 091 A C 091 D		for male cable connectors C 091 00U000 100 2 L = 100  for male receptacles C 091 00U000 110 2 L = 80		
Protective cover for female cable connectors and female receptacles.	C 091 A C 091 D		for female cable connectors C 091 00V000 100 2 L = 100  for female receptacles C 091 00V000 110 2 L = 80		
Safety washer for male and female receptacles. Packaging unit: 25 pieces	C 091 A C 091 B		VN 05 180 000 1 (1)		
Colored back-shells	C 091 A C 091 B		<b>Colour</b>	<b>Pieces</b>	<b>Part Number</b>
			blue	10 100	T 2993 510 9X T 2993 510 9C
			red	10 100	T 2993 511 9X T 2993 511 9C
			yellow	10 100	T 2993 512 9X T 2993 512 9C
			green	10 100	T 2993 513 9X T 2993 513 9C

## Summary of Part Numbers

Part Number	Page	Part Number	Page	Part Number	Page	Part Number	Page	Part Number	Page	Part Number	Page
C 091 00U000 100 2	47	C091 31C007 100 2	45	C091 31S003 100 2	45	C091 61N007 130 2	42	T 3260 018	10	T 3275 554	28
C 091 00U000 110 2	47	C091 31C008 100 2	45	C091 31S004 100 2	45	C091 61N008 110 2	42	T 3260 028	10	T 3275 951	32
C 091 00V000 100 2	47	C091 31C012 200 2	45	C091 31S005 100 2	45	C091 61N008 120 2	42	T 3260 048	10	T 3275 991	32
C 091 00V000 110 2	47	C091 31C014 200 2	45	C091 31S006 100 2	45	C091 61N008 130 2	42	T 3260 055	11	T 3276 500	35
C091 11C003 000 2	45	C091 31C105 100 2	45	C091 31S007 100 2	45	C091 61N012 210 2	42	T 3260 058	11	T 3276 518	35
C091 11C004 000 2	45	C091 31C107 100 2	45	C091 31S008 100 2	45	C091 61N014 210 2	42	T 3260 551	10	T 3276 550	35
C091 11C005 000 2	45	C091 31D003 100 2	41	C091 31S012 200 2	45	C091 61N105 110 2	42	T 3260 552	10	T 3277 000	33
C091 11C006 000 2	45	C091 31D003 101 2	41	C091 31S014 200 2	45	C091 61N105 120 2	42	T 3260 554	10	T 3277 018	33
C091 11C007 000 2	45	C091 31D004 100 2	41	C091 31S105 100 2	45	C091 61N105 130 2	42	T 3261 001	12	T 3277 050	33
C091 11C008 000 2	45	C091 31D004 101 2	41	C091 31S107 100 2	45	C091 61N107 110 2	42	T 3261 002	12	T 3277 100	33
C091 11C105 000 2	45	C091 31D005 100 2	41	C091 31T003 100 2	44	C091 61N107 120 2	42	T 3261 004	12	T 3277 150	33
C091 11C107 000 2	45	C091 31D005 101 2	41	C091 31T004 100 2	44	C091 61N107 130 2	42	T 3261 005	13	T 3277 200	34
C091 11D003 000 2	41	C091 31D006 100 2	41	C091 31T005 100 2	44	FH 0300-091	47	T 3261 013	12	T 3278 500	33
C091 11D003 001 2	41	C091 31D006 101 2	41	C091 31T006 100 2	44	HN01 015 0005 (1)	46	T 3261 018	12	T 3277 518	33
C091 11D004 000 2	41	C091 31D007 100 2	41	C091 31T007 100 2	44	HN01 015 0005 (2)	46	T 3261 028	12	T 3277 550	33
C091 11D004 001 2	41	C091 31D007 101 2	41	C091 31T008 100 2	44	HN01 015 0039 (1)	46	T 3261 048	10	T 3278 500	34
C091 11D005 000 2	41	C091 31D008 100 2	41	C091 31T012 200 2	44	HN01 015 0039 (2)	46	T 3261 055	13	T 3277 900	34
C091 11D005 001 2	41	C091 31D008 101 2	41	C091 31T014 200 2	44	HN02 015 0005 (1)	46	T 3261 058	13	T 3278 501	30
C091 11D006 000 2	41	C091 31D012 100 2	41	C091 31T105 100 2	44	HN02 015 0005 (2)	46	T 3261 551	12	T 3278 502	30
C091 11D006 001 2	41	C091 31D012 200 2	41	C091 31T107 100 2	44	HN02 015 0039 (1)	46	T 3261 552	12	T 3278 504	30
C091 11D007 000 2	41	C091 31D012 201 2	41	C091 31W003 100 2	44	HN02 015 0039 (2)	46	T 3261 554	12	T 3278 518	30
C091 11D007 001 2	41	C091 31D014 100 2	41	C091 31W004 100 2	44	N 45 091-000 1	47	T 3262 000	18	T 3278 528	30
C091 11D008 000 2	41	C091 31D014 200 2	41	C091 31W005 100 2	44	T 2993 510 9C	47	T 3262 009	18	T 3278 548	30
C091 11D008 001 2	41	C091 31D014 201 2	41	C091 31W006 100 2	44	T 2993 510 9X	47	T 3262 018	18	T 3278 551	30
C091 11D105 000 2	41	C091 31D105 100 2	41	C091 31W007 100 2	44	T 2993 511 9C	47	T 3262 100	19	T 3278 552	30
C091 11D105 001 2	41	C091 31D105 101 2	41	C091 31W008 100 2	44	T 2993 511 9X	47	T 3262 150	19	T 3278 554	30
C091 11D107 000 2	41	C091 31D107 100 2	41	C091 31W012 200 2	44	T 2993 512 9C	47	T 3262 300	18	T 3278 951	32
C091 11D107 001 2	41	C091 31D107 101 2	41	C091 31W014 200 2	44	T 2993 512 9X	47	T 3262 400	19	T 3278 991	32
C091 11G003 000 2	43	C091 31G003 100 2	43	C091 31W105 100 2	44	T 2993 513 9C	47	T 3262 550	18	T 3279 501	26
C091 11G004 000 2	43	C091 31G004 100 2	43	C091 31W107 100 2	44	T 2993 513 9X	47	T 3263 000	14	T 3279 502	26
C091 11G005 000 2	43	C091 31G005 100 2	43	C091 61G003 110 2	43	T 3200 001	10	T 3263 009	14	T 3279 504	26
C091 11G006 000 2	43	C091 31G006 100 2	43	C091 61G003 120 2	43	T 3200 002	10	T 3263 018	14	T 3279 518	26
C091 11G007 000 2	43	C091 31G007 100 2	43	C091 61G003 130 2	43	T 3200 004	10	T 3263 100	15	T 3279 528	26
C091 11G008 000 2	43	C091 31G008 100 2	43	C091 61G004 110 2	43	T 3200 005	11	T 3263 109	15	T 3279 548	26
C091 11G105 000 2	43	C091 31G012 100 2	43	C091 61G004 120 2	43	T 3200 013	10	T 3263 118	15	T 3279 551	26
C091 11G107 000 2	43	C091 31G012 200 2	43	C091 61G004 130 2	43	T 3200 018	10	T 3263 150	15	T 3279 552	26
C091 11H003 000 2	40	C091 31G014 100 2	43	C091 61G005 110 2	43	T 3200 028	10	T 3263 300	14	T 3279 554	26
C091 11H003 001 2	40	C091 31G014 200 2	43	C091 61G005 120 2	43	T 3200 048	10	T 3263 320	14	T 3300 001	10
C091 11H004 000 2	40	C091 31G105 100 2	43	C091 61G005 130 2	43	T 3200 058	11	T 3263 330	14	T 3300 002	10
C091 11H004 001 2	40	C091 31G107 100 2	43	C091 61G006 110 2	43	T 3200 552	10	T 3263 400	15	T 3300 004	10
C091 11H005 000 2	40	C091 31H003 100 2	40	C091 61G006 120 2	43	T 3201 001	12	T 3263 420	15	T 3300 005	11
C091 11H005 001 2	40	C091 31H003 101 2	40	C091 61G006 130 2	43	T 3201 002	12	T 3263 430	15	T 3300 013	10
C091 11H006 000 2	40	C091 31H004 100 2	40	C091 61G007 110 2	43	T 3201 004	12	T 3263 550	14	T 3300 018	10
C091 11H006 001 2	40	C091 31H004 101 2	40	C091 61G007 120 2	43	T 3201 005	13	T 3263 900	17	T 3300 028	10
C091 11H007 000 2	40	C091 31H005 100 2	40	C091 61G007 130 2	43	T 3201 013	12	T 3271 500	33	T 3300 048	10
C091 11H007 001 2	40	C091 31H005 101 2	40	C091 61G008 110 2	43	T 3201 018	12	T 3271 518	33	T 3300 055	11
C091 11H008 000 2	40	C091 31H006 100 2	40	C091 61G008 120 2	43	T 3201 028	12	T 3271 550	33	T 3300 058	11
C091 11H008 001 2	40	C091 31H006 101 2	40	C091 61G008 130 2	43	T 3201 048	12	T 3274 005	24	T 3300 551	10
C091 11H105 000 2	40	C091 31H007 100 2	40	C091 61G012 110 2	43	T 3201 058	13	T 3274 055	24	T 3300 552	10
C091 11H105 001 2	40	C091 31H007 101 2	40	C091 61G012 210 2	43	T 3202 000	18	T 3274 058	24	T 3300 554	10
C091 11H107 000 2	40	C091 31H008 100 2	40	C091 61G014 110 2	43	T 3202 009	18	T 3274 501	24	T 3301 001	12
C091 11H107 001 2	40	C091 31H008 101 2	40	C091 61G014 210 2	43	T 3202 018	18	T 3274 502	24	T 3301 002	12
C091 11N003 000 2	42	C091 31H012 100 2	40	C091 61G105 110 2	43	T 3202 100	19	T 3274 504	24	T 3301 004	12
C091 11N004 000 2	42	C091 31H012 200 2	40	C091 61G105 120 2	43	T 3202 300	18	T 3274 518	24	T 3301 005	13
C091 11N005 000 2	42	C091 31H012 201 2	40	C091 61G105 130 2	43	T 3202 400	19	T 3274 528	24	T 3301 013	12
C091 11N006 000 2	42	C091 31H014 100 2	40	C091 61G107 110 2	43	T 3203 000	14	T 3274 548	24	T 3301 018	12
C091 11N007 000 2	42	C091 31H014 200 2	40	C091 61G107 120 2	43	T 3203 009	14	T 3274 551	24	T 3301 028	12
C091 11N008 000 2	42	C091 31H014 201 2	40	C091 61G107 130 2	43	T 3203 018	14	T 3274 552	24	T 3301 048	12
C091 11N105 000 2	42	C091 31H105 100 2	40	C091 61N003 110 2	42	T 3203 100	15	T 3274 554	24	T 3301 055	13
C091 11N107 000 2	42	C091 31H105 101 2	40	C091 61N003 120 2	42	T 3203 109	15	T 3274 951	32	T 3301 058	13
C091 11W003 000 2	44	C091 31H107 100 2	40	C091 61N003 130 2	42	T 3203 118	15	T 3274 991	32	T 3301 551	12
C091 11W004 000 2	44	C091 31H107 101 2	40	C091 61N004 110 2	42	T 3203 300	14	T 3275 005	28	T 3301 552	12
C091 11W005 000 2	44	C091 31N003 100 2	42	C091 61N004 120 2	42	T 3203 320	14	T 3275 055	28	T 3301 554	12
C091 11W006 000 2	44	C091 31N004 100 2	42	C091 61N004 130 2	42	T 3203 330	14	T 3275 058	28	T 3302 000	18
C091 11W007 000 2	44	C091 31N005 100 2	42	C091 61N005 110 2	42	T 3203 400	15	T 3275 501	28	T 3302 009	18
C091 11W008 000 2	44	C091 31N006 100 2	42	C091 61N005 120 2	42	T 3203 420	15	T 3275 502	28	T 3302 018	18
C091 11W105 000 2	44	C091 31N007 100 2	42	C091 61N005 130 2	42	T 3203 430	15	T 3275 504	28	T 3302 100	19
C091 11W107 000 2	44	C091 31N008 100 2	42	C091 61N006 110 2	42	T 3260 001	10	T 3275 518	28	T 3302 150	19
C091 31C003 100 2	45	C091 31N012 200 2	42	C091 61N006 120 2	42	T 3260 002	10	T 3275 528	28	T 3302 300	18
C091 31C004 100 2	45	C091 31N014 200 2	42	C091 61N006 130 2	42	T 3260 004	10	T 3275 548	28	T 3302 400	19
C091 31C005 100 2	45	C091 31N105 100 2	42	C091 61N007 110 2	42	T 3260 005	11	T 3275 551	28	T 3302 550	18
C091 31C006 100 2	45	C091 31N107 100 2	42	C091 61N007 120 2	42	T 3260 013	10	T 3275 552	28	T 3303 000	14

## Summary of Part Numbers

Part Number	Page	Part Number	Page	Part Number	Page	Part Number	Page	Part Number	Page	Part Number	Page
T 3303 009	14	T 3329 551	26	T 3361 130	12	T 3377 518	33	T 3399 504	26	T 3424 554	24
T 3303 018	14	T 3329 552	26	T 3361 551	12	T 3377 550	33	T 3399 518	26	T 3424 951	32
T 3303 100	15	T 3329 554	26	T 3361 552	12	T 3377 600	34	T 3399 528	26	T 3424 991	32
T 3303 109	15	T 3356 004	10	T 3361 554	12	T 3378 501	30	T 3399 548	26	T 3425 005	28
T 3303 118	15	T 3356 005	11	T 3362 000	18	T 3378 502	30	T 3399 551	26	T 3425 055	28
T 3303 150	15	T 3356 018	10	T 3362 009	18	T 3378 504	30	T 3399 552	26	T 3425 058	28
T 3303 300	14	T 3356 028	10	T 3362 010	18	T 3378 518	30	T 3399 554	26	T 3425 501	28
T 3303 320	14	T 3356 048	10	T 3362 018	18	T 3378 528	30	T 3400 001	10	T 3425 502	28
T 3303 330	14	T 3356 055	11	T 3362 100	19	T 3378 548	30	T 3400 002	10	T 3425 504	28
T 3303 400	15	T 3356 058	11	T 3362 150	19	T 3378 551	30	T 3400 004	10	T 3425 518	28
T 3303 420	15	T 3356 551	10	T 3362 300	18	T 3378 552	30	T 3400 005	11	T 3425 528	28
T 3303 430	15	T 3356 552	10	T 3362 400	19	T 3378 554	30	T 3400 013	10	T 3425 548	28
T 3303 550	14	T 3356 554	10	T 3362 550	18	T 3378 951	32	T 3400 018	10	T 3425 551	28
T 3321 500	33	T 3357 004	12	T 3363 218	16	T 3378 991	32	T 3400 028	10	T 3425 552	28
T 3321 518	33	T 3357 005	13	T 3363 228	16	T 3379 501	26	T 3400 048	10	T 3425 554	28
T 3321 550	33	T 3357 018	12	T 3363 000	14	T 3379 502	26	T 3400 055	11	T 3425 951	32
T 3324 005	24	T 3357 028	12	T 3363 009	14	T 3379 504	26	T 3400 058	11	T 3425 991	32
T 3324 055	24	T 3357 048	12	T 3363 010	14	T 3379 518	26	T 3400 551	10	T 3426 500	35
T 3324 058	24	T 3357 055	13	T 3363 018	14	T 3379 528	26	T 3400 552	10	T 3426 518	35
T 3324 501	24	T 3357 058	13	T 3363 100	15	T 3379 548	26	T 3400 554	10	T 3426 550	35
T 3324 502	24	T 3357 551	12	T 3363 109	15	T 3379 551	26	T 3401 001	12	T 3427 000	33
T 3324 504	24	T 3357 552	12	T 3363 118	15	T 3379 552	26	T 3401 002	12	T 3427 018	33
T 3324 518	24	T 3357 554	12	T 3363 150	15	T 3379 554	26	T 3401 004	12	T 3427 050	33
T 3324 528	24	T 3358 009	18	T 3363 300	14	T 3391 500	33	T 3401 005	13	T 3427 100	33
T 3324 548	24	T 3358 018	18	T 3363 320	14	T 3391 518	33	T 3401 013	12	T 3427 150	33
T 3324 551	24	T 3358 100	19	T 3363 330	14	T 3391 550	33	T 3401 018	12	T 3427 200	34
T 3324 552	24	T 3358 150	19	T 3363 400	15	T 3394 005	24	T 3401 028	12	T 3427 500	33
T 3324 554	24	T 3358 300	18	T 3363 420	15	T 3394 055	24	T 3401 048	12	T 3427 518	33
T 3324 951	32	T 3358 400	19	T 3363 430	15	T 3394 058	24	T 3401 055	13	T 3427 550	33
T 3324 991	32	T 3358 550	18	T 3363 550	14	T 3394 501	24	T 3401 058	13	T 3427 600	34
T 3325 005	28	T 3359 009	14	T 3363 902	16	T 3394 502	24	T 3401 551	12	T 3428 501	30
T 3325 055	28	T 3359 018	14	T 3371 500	33	T 3394 504	24	T 3401 552	12	T 3428 502	30
T 3325 058	28	T 3359 100	15	T 3371 518	33	T 3394 518	24	T 3401 554	12	T 3428 504	30
T 3325 501	28	T 3359 109	15	T 3371 550	33	T 3394 528	24	T 3402 000	18	T 3428 518	30
T 3325 502	28	T 3359 118	15	T 3374 005	24	T 3394 548	24	T 3402 009	18	T 3428 528	30
T 3325 504	28	T 3359 150	15	T 3374 055	24	T 3394 551	24	T 3402 018	18	T 3428 548	30
T 3325 518	28	T 3359 300	14	T 3374 058	24	T 3394 552	24	T 3402 100	19	T 3428 551	30
T 3325 528	28	T 3359 320	14	T 3374 501	24	T 3394 554	24	T 3402 150	19	T 3428 552	30
T 3325 548	28	T 3359 330	14	T 3374 502	24	T 3395 005	28	T 3402 300	18	T 3428 554	30
T 3325 551	28	T 3359 400	15	T 3374 504	24	T 3395 055	28	T 3402 400	19	T 3428 551	32
T 3325 552	28	T 3359 420	15	T 3374 518	24	T 3395 058	28	T 3402 550	18	T 3428 991	32
T 3325 554	28	T 3359 430	15	T 3374 528	24	T 3395 501	28	T 3403 218	16	T 3429 501	26
T 3325 951	32	T 3359 550	14	T 3374 548	24	T 3395 502	28	T 3403 228	16	T 3429 502	26
T 3325 991	32	T 3359 900	17	T 3374 551	24	T 3395 504	28	T 3403 000	14	T 3429 504	26
T 3326 500	35	T 3360 001	10	T 3374 552	24	T 3395 518	28	T 3403 009	14	T 3429 518	26
T 3326 518	35	T 3360 002	10	T 3374 554	24	T 3395 528	28	T 3403 018	14	T 3429 528	26
T 3326 550	35	T 3360 004	10	T 3374 951	32	T 3395 548	28	T 3403 100	15	T 3429 548	26
T 3327 000	33	T 3360 005	11	T 3374 991	32	T 3395 551	28	T 3403 109	15	T 3429 551	26
T 3327 018	33	T 3360 010	10	T 3375 005	28	T 3395 552	28	T 3403 118	15	T 3429 552	26
T 3327 050	33	T 3360 013	10	T 3375 055	28	T 3395 554	28	T 3403 150	15	T 3429 554	26
T 3327 100	33	T 3360 018	10	T 3375 058	28	T 3396 500	35	T 3403 300	14	T 3431 500	33
T 3327 150	33	T 3360 020	10	T 3375 501	28	T 3396 518	35	T 3403 320	14	T 3431 518	33
T 3327 500	33	T 3360 028	10	T 3375 502	28	T 3396 550	35	T 3403 330	14	T 3431 550	33
T 3327 518	33	T 3360 048	10	T 3375 504	28	T 3397 100	33	T 3403 400	15	T 3434 005	24
T 3327 550	33	T 3360 055	11	T 3375 518	28	T 3397 150	33	T 3403 420	15	T 3434 055	24
T 3328 501	30	T 3360 058	11	T 3375 528	28	T 3397 200	34	T 3403 430	15	T 3434 058	24
T 3328 502	30	T 3360 130	10	T 3375 548	28	T 3397 500	33	T 3403 550	14	T 3434 501	24
T 3328 504	30	T 3360 551	10	T 3375 551	28	T 3397 518	33	T 3403 902	16	T 3434 502	24
T 3328 518	30	T 3360 552	10	T 3375 552	28	T 3397 550	33	T 3421 500	33	T 3434 504	24
T 3328 528	30	T 3360 554	10	T 3375 554	28	T 3397 600	34	T 3421 518	33	T 3434 518	24
T 3328 548	30	T 3361 001	12	T 3375 951	32	T 3397 900	34	T 3421 550	33	T 3434 528	24
T 3328 551	30	T 3361 002	12	T 3375 991	32	T 3398 501	30	T 3424 005	24	T 3434 548	24
T 3328 552	30	T 3361 004	12	T 3376 500	35	T 3398 502	30	T 3424 055	24	T 3434 551	24
T 3328 554	30	T 3361 005	13	T 3376 518	35	T 3398 504	30	T 3424 058	24	T 3434 552	24
T 3328 951	32	T 3361 010	12	T 3376 550	35	T 3398 518	30	T 3424 501	24	T 3434 554	24
T 3328 991	32	T 3361 013	12	T 3377 000	33	T 3398 528	30	T 3424 502	24	T 3434 951	32
T 3329 501	26	T 3361 018	12	T 3377 018	33	T 3398 548	30	T 3424 504	24	T 3434 991	32
T 3329 502	26	T 3361 020	12	T 3377 050	33	T 3398 551	30	T 3424 518	24	T 3435 005	28
T 3329 504	26	T 3361 028	12	T 3377 100	33	T 3398 552	30	T 3424 528	24	T 3435 055	28
T 3329 518	26	T 3361 048	12	T 3377 150	33	T 3398 554	30	T 3424 548	24	T 3435 058	28
T 3329 528	26	T 3361 055	13	T 3377 200	34	T 3399 501	26	T 3424 551	24	T 3435 501	28
T 3329 548	26	T 3361 058	13	T 3377 500	33	T 3399 502	26	T 3424 552	24	T 3435 502	28

## Summary of Part Numbers

Part Number	Page	Part Number	Page	Part Number	Page	Part Number	Page	Part Number	Page	Part Number	Page
T 3435 504	28	T 3447 500	33	T 3484 004	10	T 3505 554	12	T 3529 528	26	T 3644 504	24
T 3435 518	28	T 3447 518	33	T 3484 005	11	T 3506 000	18	T 3529 548	26	T 3644 518	24
T 3435 528	28	T 3447 550	33	T 3484 013	10	T 3506 009	18	T 3529 551	26	T 3644 528	24
T 3435 548	28	T 3447 900	34	T 3484 018	10	T 3506 018	18	T 3529 552	26	T 3644 548	24
T 3435 551	28	T 3448 501	30	T 3484 028	10	T 3506 100	19	T 3529 554	26	T 3645 005	28
T 3435 552	28	T 3448 502	30	T 3484 048	10	T 3506 150	19	T 3621 500	33	T 3645 058	28
T 3435 554	28	T 3448 504	30	T 3484 055	11	T 3506 300	18	T 3621 518	33	T 3645 501	28
T 3435 951	32	T 3448 518	30	T 3484 058	11	T 3506 400	19	T 3624 005	24	T 3645 502	28
T 3435 991	32	T 3448 528	30	T 3484 551	10	T 3506 550	18	T 3624 058	24	T 3645 504	28
T 3436 500	35	T 3448 548	30	T 3484 552	10	T 3507 000	14	T 3624 501	24	T 3645 518	28
T 3436 518	35	T 3448 551	30	T 3484 554	10	T 3507 009	14	T 3624 502	24	T 3645 528	28
T 3436 550	35	T 3448 552	30	T 3485 001	12	T 3507 018	14	T 3624 504	24	T 3645 548	28
T 3437 000	33	T 3448 554	30	T 3485 002	12	T 3507 100	15	T 3624 518	24	T 3645 500	35
T 3437 018	33	T 3449 501	26	T 3485 004	12	T 3507 109	15	T 3624 528	24	T 3646 518	35
T 3437 050	33	T 3449 502	26	T 3485 005	13	T 3507 118	15	T 3624 548	24	T 3647 100	33
T 3437 100	33	T 3449 504	26	T 3485 013	12	T 3507 150	15	T 3625 005	28	T 3647 500	33
T 3437 150	33	T 3449 518	26	T 3485 018	12	T 3507 300	14	T 3625 058	28	T 3647 518	33
T 3437 500	33	T 3449 528	26	T 3485 028	12	T 3507 320	14	T 3625 501	28	T 3648 501	30
T 3437 518	33	T 3449 548	26	T 3485 048	12	T 3507 330	14	T 3625 502	28	T 3648 502	30
T 3437 550	33	T 3449 551	26	T 3485 055	13	T 3507 400	15	T 3625 504	28	T 3648 504	30
T 3438 501	30	T 3449 552	26	T 3485 058	13	T 3507 420	15	T 3625 518	28	T 3648 518	30
T 3438 502	30	T 3449 554	26	T 3485 551	12	T 3507 430	15	T 3625 528	28	T 3648 528	30
T 3438 504	30	T 3475 001	10	T 3485 552	12	T 3507 550	14	T 3625 548	28	T 3648 548	30
T 3438 518	30	T 3475 002	10	T 3485 554	12	T 3507 900	17	T 3626 500	35	T 3649 501	26
T 3438 528	30	T 3475 004	10	T 3486 000	18	T 3521 500	33	T 3626 518	35	T 3649 502	26
T 3438 548	30	T 3475 005	11	T 3486 009	18	T 3521 518	33	T 3627 100	33	T 3649 504	26
T 3438 551	30	T 3475 013	10	T 3486 018	18	T 3521 550	33	T 3627 500	33	T 3649 518	26
T 3438 552	30	T 3475 018	10	T 3486 100	19	T 3524 005	24	T 3627 518	33	T 3649 528	26
T 3438 554	30	T 3475 028	10	T 3486 150	19	T 3524 055	24	T 3628 501	30	T 3649 548	26
T 3438 951	32	T 3475 048	10	T 3486 300	18	T 3524 058	24	T 3628 502	30	T 3650 000	10
T 3438 991	32	T 3475 055	11	T 3486 400	19	T 3524 501	24	T 3628 504	30	T 3650 001	10
T 3439 501	26	T 3475 058	11	T 3486 550	18	T 3524 502	24	T 3628 518	30	T 3650 002	10
T 3439 502	26	T 3475 551	10	T 3487 000	14	T 3524 504	24	T 3628 528	30	T 3650 004	10
T 3439 504	26	T 3475 552	10	T 3487 009	14	T 3524 518	24	T 3628 548	30	T 3650 005	11
T 3439 518	26	T 3475 554	10	T 3487 018	14	T 3524 528	24	T 3629 501	26	T 3650 058	11
T 3439 528	26	T 3476 001	12	T 3487 100	15	T 3524 548	24	T 3629 502	26	T 3651 000	12
T 3439 548	26	T 3476 002	12	T 3487 109	15	T 3524 551	24	T 3629 504	26	T 3651 001	12
T 3439 551	26	T 3476 004	12	T 3487 118	15	T 3524 552	24	T 3629 518	26	T 3651 002	12
T 3439 552	26	T 3476 005	13	T 3487 150	15	T 3524 554	24	T 3629 528	26	T 3651 004	12
T 3439 554	26	T 3476 013	12	T 3487 300	14	T 3525 005	28	T 3629 548	26	T 3651 005	13
T 3441 500	33	T 3476 018	12	T 3487 320	14	T 3525 055	28	T 3635 000	10	T 3651 058	13
T 3441 518	33	T 3476 028	12	T 3487 330	14	T 3525 058	28	T 3635 001	10	T 3652 000	18
T 3441 550	33	T 3476 048	12	T 3487 400	15	T 3525 501	28	T 3635 002	10	T 3652 001	18
T 3444 005	24	T 3476 055	13	T 3487 420	15	T 3525 502	28	T 3635 004	10	T 3652 009	18
T 3444 055	24	T 3476 058	13	T 3487 430	15	T 3525 504	28	T 3635 005	11	T 3652 100	19
T 3444 058	24	T 3476 551	12	T 3487 550	14	T 3525 518	28	T 3635 058	11	T 3652 304	18
T 3444 501	24	T 3476 552	12	T 3487 900	17	T 3525 528	28	T 3636 000	12	T 3652 404	19
T 3444 502	24	T 3476 554	12	T 3504 001	10	T 3525 548	28	T 3636 001	12	T 3653 000	14
T 3444 504	24	T 3477 000	18	T 3504 002	10	T 3525 551	28	T 3636 002	12	T 3653 004	14
T 3444 518	24	T 3477 009	18	T 3504 004	10	T 3525 552	28	T 3636 004	12	T 3653 009	14
T 3444 528	24	T 3477 018	18	T 3504 005	11	T 3525 554	28	T 3636 005	13	T 3653 100	15
T 3444 548	24	T 3477 100	19	T 3504 013	10	T 3526 500	35	T 3636 058	13	T 3653 109	15
T 3444 551	24	T 3477 150	19	T 3504 018	10	T 3526 518	35	T 3637 000	18	T 3653 118	15
T 3444 552	24	T 3477 300	18	T 3504 028	10	T 3526 550	35	T 3637 001	18	T 3653 304	14
T 3444 554	24	T 3477 400	19	T 3504 048	10	T 3527 100	33	T 3637 009	18	T 3653 404	15
T 3445 005	28	T 3477 550	18	T 3504 055	11	T 3527 150	33	T 3637 100	19	VN 05 180 000 1 (1)	47
T 3445 055	28	T 3478 000	14	T 3504 058	11	T 3527 500	33	T 3637 304	18	VN01 015 0005 (1)	46
T 3445 058	28	T 3478 009	14	T 3504 551	10	T 3527 518	33	T 3637 404	19	VN01 015 0005 (2)	46
T 3445 501	28	T 3478 018	14	T 3504 552	10	T 3527 900	34	T 3638 000	14	VN01 015 0039 (1)	46
T 3445 502	28	T 3478 100	15	T 3504 554	10	T 3528 501	30	T 3638 004	14	VN01 015 0039 (2)	46
T 3445 504	28	T 3478 109	15	T 3505 001	12	T 3528 502	30	T 3638 009	14	VN02 015 0005 (1)	46
T 3445 518	28	T 3478 118	15	T 3505 002	12	T 3528 504	30	T 3638 100	15	VN02 015 0005 (2)	46
T 3445 528	28	T 3478 150	15	T 3505 004	12	T 3528 518	30	T 3638 109	15	VN02 015 0039 (1)	46
T 3445 548	28	T 3478 300	14	T 3505 005	13	T 3528 528	30	T 3638 118	15	VN02 015 0039 (2)	46
T 3445 551	28	T 3478 320	14	T 3505 013	12	T 3528 548	30	T 3638 304	14	ZN01 015 0005 (1)	46
T 3445 552	28	T 3478 330	14	T 3505 018	12	T 3528 551	30	T 3638 404	15	ZN01 015 0005 (2)	46
T 3445 554	28	T 3478 400	15	T 3505 028	12	T 3528 552	30	T 3641 500	33	ZN01 015 0039 (1)	46
T 3446 500	35	T 3478 420	15	T 3505 048	12	T 3528 554	30	T 3641 518	33	ZN01 015 0039 (2)	46
T 3446 518	35	T 3478 430	15	T 3505 055	13	T 3529 501	26	T 3644 005	24	ZN02 015 0005 (1)	46
T 3446 550	35	T 3478 550	14	T 3505 058	13	T 3529 502	26	T 3644 058	24	ZN02 015 0005 (2)	46
T 3447 100	33	T 3484 001	10	T 3505 551	12	T 3529 504	26	T 3644 501	24	ZN02 015 0039 (1)	46
T 3447 150	33	T 3484 002	10	T 3505 552	12	T 3529 518	26	T 3644 502	24	ZN02 015 0039 (2)	46

## Representatives: Europe

Amphenol Benelux BV  
Peppelkade 2 a  
NL-3992 AK Houten  
Phone +31 / 30 / 6 35 80 00  
Fax +31 / 30 / 6 37 70 34  
E-mail: info@amphenol-nl.com

Amphenol Ges. m. b. H.  
Johnstraße 42, Top 3A  
A-1150 Wien  
Phone +43 / 1 / 9 85 15 11  
Fax +43 / 1 / 9 82 61 01  
Telex 132 661 amphw a  
E-mail: info@amphenol-at.com

Amphenol Ibérica  
Calle Cuba No. 6, 2-5  
E-28820 Coslada  
Madrid, Spain  
Phone +34 / 91 / 673 / 2235  
Fax +34 / 91 / 674 / 0893  
E-mail: info@amphenol-nl.com

Amphenol Italia S.p.A.  
Galleria Gandhi, 2/27  
I-20017 Mazzo di Rho  
(Milano)  
Phone +39 / 2 / 93 90 41 92  
Fax +39 / 2 / 93 90 10 30  
E-mail: info@amphenol-it.com

Amphenol Limited  
Thanet Way, Whitstable  
GB-Kent CT5 3JF  
Phone +44 / 12 27 / 77 32 00  
Fax +44 / 12 27 / 77 17 73  
Telex 851 966 507

Amphenol Poland  
18 Niedurnego St.  
41-600 Swietochlowice  
(Katowice), Poland.  
Phone +48 / 32 / 45 36 34  
Fax +48 / 32 / 45 36 34  
Mobile +48 / 601 / 42 13 64  
E-mail: info@amphenol-at.com

Amphenol Scandinavia  
Johanneslundsvägen 2  
S-194 61 Upplands Väsby  
Phone +46 / 8 / 59 41 04 40  
Fax +46 / 8 / 59 03 38 00  
E-mail: info@amphenol-se.com

Amphenol Socapex France  
11 Avenue Durbonnet  
BP 5  
F-92407 Courbevoie Cedex  
Phone +33 / 1 / 49 05 30 00  
Fax +33 / 1 / 49 05 30 43  
Telex MSTH 215 709 F

Amphenol Switzerland  
Route du Roule 41  
CH-1723 Marly  
Phone +41 / 26 / 4 36 38 18  
Fax +41 / 26 / 4 30 01 77  
E-mail: info@amphenol-nl.com

## Representatives: North America

Amphenol Corporation  
Corporate Headquarters  
358 Hall Avenue  
Wallingford, CT 06492  
Phone +1 / 2 03 / 2 65 / 89 00  
Fax +1 / 2 03 / 2 65 / 86 28

Amphenol-Tuchel Electronics  
Representative Office  
6900 Haggerty Road  
Suite 200  
Canton, Michigan 48187  
Phone +1 / 734 / 451 6400  
Fax +1 / 734 / 451 7197

## Representatives: Asia

Amphenol East Asia Limited  
Units 3-19, 10/F & 11/F  
Wah Luen Industrial Centre  
15-21 Wong Chuk Yeung Street  
Fotan, Shatin, N T, Hong Kong  
Phone +8 52 / 26 99 / 26 63  
Fax +8 52 / 26 88 / 09 74  
Telex 36502 AMPEA HX

Amphetronix Limited  
Plot No. 105 Bhosari  
Industrial Area  
Pune - 411 026  
India  
Phone +91 / 2 12 / 79 03 63  
Fax +91 / 2 12 / 79 05 81  
Telex 953 146237

Amphenol Japan, K.K.  
2-3-27, Kudan Minami  
Chiyoda-Ku  
Tokyo 102  
Japan  
Phone +81 / 3 / 32 63 / 56 11  
Fax +81 / 3 / 52 76 / 70 59

Amphenol Kai Jack  
No. 110, Sec 1  
Bao-An Road  
Ren-Der Shiang  
Tainan, Taiwan  
Phone +886 / 6 / 266 / 1011  
Fax +886 / 6 / 266 / 4633

## Representatives: Australia & New Zealand

Amphenol Australia Ltd.  
248 Wickham Road,  
Moorabbin  
Victoria 3189, Melbourne  
Australia  
Phone +61 / 3 / 9555 / 1566  
Fax +61 / 3 / 9553 / 3801

Your engineering sales representative:

## Amphenol-Tuchel Electronics GmbH

August-Haesser- Str. 10 · D-74080 Heilbronn · Phone + 49 / (0)71 31 / 9 29-0 · Telefax + 49 / (0)71 31 / 9 29- 486

Printed on chlorine-free bleached paper. Specifications may be changed without notice. Copyright 02/00 by Amphenol-Tuchel Electronics GmbH, Germany