

## General Description

The MIC5200 is an efficient linear voltage regulator with very low dropout voltage (typically 17mV at light loads and 200mV at 100mA), and very low ground current (1mA at 100mA output), offering better than 1% initial accuracy with a logic compatible ON/OFF switching input. Designed especially for hand-held battery powered devices, the MIC5200 is switched by a CMOS or TTL compatible logic signal. The ENABLE control may be tied directly to  $V_{IN}$  if unneeded. When disabled, power consumption drops nearly to zero. The ground current of the MIC5200 increases only slightly in dropout, further prolonging battery life. Key MIC5200 features include protection against reversed battery, current limiting, and over-temperature shutdown.

The MIC5200 is available in several fixed voltages and accuracy configurations. Other options are available; contact Micrel for details.

## Features

- High output voltage accuracy
- Variety of output voltages
- Guaranteed 100mA output
- Low quiescent current
- Low dropout voltage
- Extremely tight load and line regulation
- Very low temperature coefficient
- Current and thermal limiting
- Zero OFF mode current
- Logic-controlled electronic shutdown
- Available in 8-lead SOIC, MM8™ 8-lead MSOP, and SOT-223 packages

## Applications

- Cellular Telephones
- Laptop, Notebook, and Palmtop Computers
- Battery Powered Equipment
- PCMCIA  $V_{CC}$  and  $V_{PP}$  Regulation/Switching
- Bar Code Scanners
- SMPS Post-Regulator/ DC to DC Modules
- High Efficiency Linear Power Supplies

## Typical Application

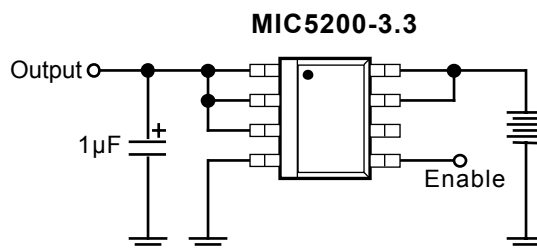

## Ordering Information

Part Number		Voltage	Accuracy	Junction Temp. Range*	Package
Standard	Pb-Free				
MIC5200-3.0BM	MIC5200-3.0YM	3.0	1%	-40°C to +125°C	8-Pin SOIC
MIC5200-3.3BM	MIC5200-3.3YM	3.3	1%	-40°C to +125°C	8-Pin SOIC
MIC5200-4.8BM	MIC5200-4.8YM	4.8	1%	-40°C to +125°C	8-Pin SOIC
MIC5200-5.0BM	MIC5200-5.0YM	5.0	1%	-40°C to +125°C	8-Pin SOIC
MIC5200-3.3BMM	MIC5200-3.3YMM	3.3	1%	-40°C to +125°C	8-Pin MSOP
MIC5200-5.0BMM	MIC5200-5.0YMM	5.0	1%	-40°C to +125°C	8-Pin MSOP
MIC5200-3.0BS	MIC5200-3.0YS	3.0	1%	-40°C to +125°C	3-lead SOT-223
MIC5200-3.3BS	MIC5200-3.3YS	3.3	1%	-40°C to +125°C	3-lead SOT-223
MIC5200-4.8BS	MIC5200-4.8YS	4.8	1%	-40°C to +125°C	3-lead SOT-223
MIC5200-5.0BS	MIC5200-5.0YS	5.0	1%	-40°C to +125°C	3-lead SOT-223

\* Other voltage options available. Contact Micrel Marketing for information.

## Pin Configuration

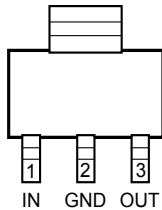

**MIC5200-x.xBS  
(SOT-223)**

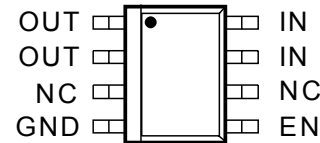

**MIC5200-x.xBM  
(SOIC-8)  
MIC5200-x.xBM  
(MSOP-8)**

EN may be tied directly to  $V_{IN}$

## Pin Description

Pin Number SOT-223	Pin Number SO-8, MSOP-8	Pin Name	Pin Function
3	1, 2	OUT	Output: Pins 1 and 2 must be externally connected together.
	3, 6	NC	(not internally connected): Connect to ground plane for lowest thermal resistance.
2, TAB	4	GND	Ground: Ground pin and TAB are internally connected.
	5	EN	Enable/Shutdown (Input): TTL compatible input. High = enabled; low = shutdown.
1	7, 8	IN	Supply Input: Pins 7 and 8 must be externally connected together.

## Absolute Maximum Ratings

Power Dissipation.....	Internally Limited
Lead Temperature (soldering, 5 sec.).....	260°C
Operating Junction Temperature Range.....	-40°C to +125°C
Input Supply Voltage.....	-20V to +60V
Enable Input Voltage.....	-20V to +60V
Thermal Characteristics	
SOT-223 ( $\theta_{JC}$ ).....	15°C/W
SO-8 ( $\theta_{JA}$ ).....	See Note 1

## Recommended Operating Conditions

Input Voltage.....	2.5V to 26V
Operating Junction Temperature Range.....	-40°C to +125°C
Enable Input Voltage.....	-20V to $V_{IN}$

**Absolute Maximum Ratings** indicate limits beyond which damage to the device may occur. Electrical specifications do not apply when operating the device beyond its specified **Operating Ratings**.

## Electrical Characteristics

Limits in standard typeface are for  $T_J = 25^\circ\text{C}$  and limits in **boldface** apply over the junction temperature range of  $-40^\circ\text{C}$  to  $+125^\circ\text{C}$ . Unless otherwise specified,  $V_{IN} = V_{OUT} + 1\text{V}$ ,  $I_L = 1\text{mA}$ ,  $C_L = 3.3\mu\text{F}$ , and  $V_{ENABLE} \geq 2.0\text{V}$

Symbol	Parameter	Conditions	Min	Typical	Max	Units
$V_O$	Output Voltage Accuracy	Variation from specified $V_{OUT}$	-1 <b>-2</b>		1 <b>2</b>	%
$\frac{\Delta V_O}{\Delta T}$	Output Voltage Temperature Coef.	(Note 2)		<b>40</b>	<b>150</b>	ppm/°C
$\frac{\Delta V_O}{V_{IN}}$	Line Regulation	$V_{IN} = V_{OUT} + 1\text{V}$ to 26V		0.004	0.10 <b>0.40</b>	%
$\frac{\Delta V_O}{V_{OUT}}$	Load Regulation	$I_L = 0.1\text{mA}$ to 100mA (Note 3)		0.04	0.16 <b>0.30</b>	%
$V_{IN} - V_O$	Dropout Voltage (Note 4)	$I_L = 100\mu\text{A}$ $I_L = 20\text{mA}$ $I_L = 30\text{mA}$ $I_L = 50\text{mA}$ $I_L = 100\text{mA}$		17 130 150 190 230	<b>350</b>	mV
$I_{GND}$	Quiescent Current	$V_{ENABLE} \leq 0.7\text{V}$ (Shutdown)		0.01	10	$\mu\text{A}$
$I_{GND}$	Ground Pin Current	$V_{ENABLE} \geq 2.0\text{V}$ , $I_L = 100\mu\text{A}$ $I_L = 20\text{mA}$ $I_L = 30\text{mA}$ $I_L = 50\text{mA}$ $I_L = 100\text{mA}$		130 270 330 500 1000	350 <b>1500</b>	$\mu\text{A}$
PSRR	Ripple Rejection			70		dB
$I_{GNDDO}$	Ground Pin Current at Dropout	$V_{IN} = 0.5\text{V}$ less than specified $V_{OUT}$ $I_L = 100\mu\text{A}$ (Note 5)		270	<b>330</b>	$\mu\text{A}$
$I_{LIMIT}$	Current Limit	$V_{OUT} = 0\text{V}$	100	<b>250</b>		mA
$\frac{\Delta V_O}{\Delta P_D}$	Thermal Regulation	(Note 6)		0.05		%/W
$e_n$	Output Noise			100		$\mu\text{V}$

### ENABLE Input

Symbol	Parameter	Conditions	Min	Typical	Max	Units
$V_{IL}$	Input Voltage Level Logic Low Logic High	OFF ON	<b>2.0</b>		<b>0.7</b>	V
$I_{IL}$ $I_{IH}$	ENABLE Input Current	$V_{IL} \leq 0.7\text{V}$ $V_{IH} \geq 2.0\text{V}$		0.01 15	1 <b>50</b>	$\mu\text{A}$

- Note 1:** Absolute maximum ratings indicate limits beyond which damage to the component may occur. Electrical specifications do not apply when operating the device outside of its rated operating conditions. The maximum allowable power dissipation is a function of the maximum junction temperature,  $T_{J(MAX)}$ , the junction-to-ambient thermal resistance,  $\theta_{JA}$ , and the ambient temperature,  $T_A$ . The maximum allowable power dissipation at any ambient temperature is calculated using:  $P_{(MAX)} = (T_{J(MAX)} - T_A) \div \theta_{JA}$ . Exceeding the maximum allowable power dissipation will result in excessive die temperature, and the regulator will go into thermal shutdown. The  $\theta_{JC}$  of the MIC5200-xxBS is 15°C/W and  $\theta_{JA}$  for the MIC5200BM is 160°C/W mounted on a PC board (see “Thermal Considerations” section for further details).
- Note 2:** Output voltage temperature coefficient is defined as the worst case voltage change divided by the total temperature range.
- Note 3:** Regulation is measured at constant junction temperature using low duty cycle pulse testing. Parts are tested for load regulation in the load range from 0.1mA to 100mA. Changes in output voltage due to heating effects are covered by the thermal regulation specification.
- Note 4:** Dropout Voltage is defined as the input to output differential at which the output voltage drops 2% below its nominal value measured at 1V differential.
- Note 5:** Ground pin current is the regulator quiescent current plus pass transistor base current. The total current drawn from the supply is the sum of the load current plus the ground pin current.
- Note 6:** Thermal regulation is defined as the change in output voltage at a time  $t$  after a change in power dissipation is applied, excluding load or line regulation effects. Specifications are for a 100mA load pulse at  $V_{IN} = 26V$  for  $t = 10ms$ .

# Typical Characteristics

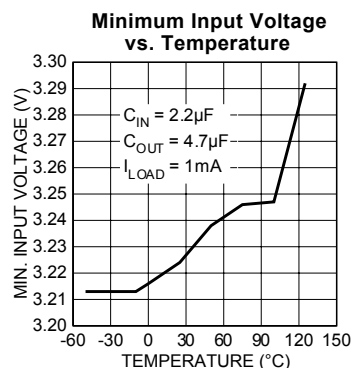
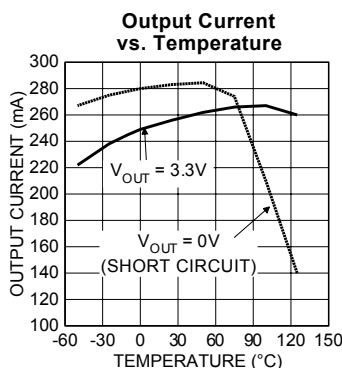
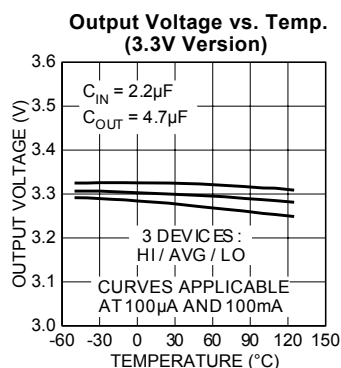
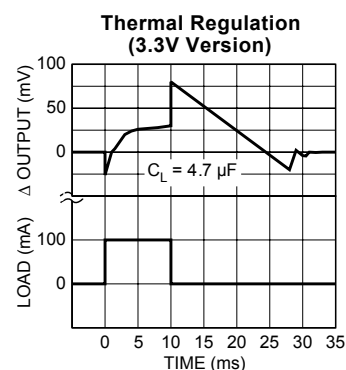
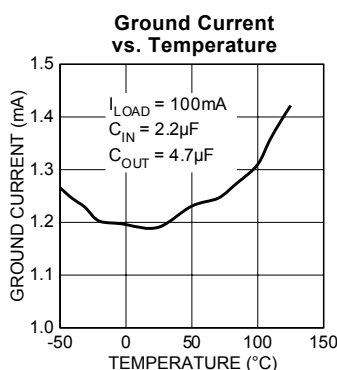
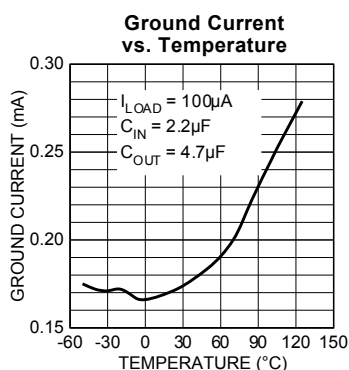
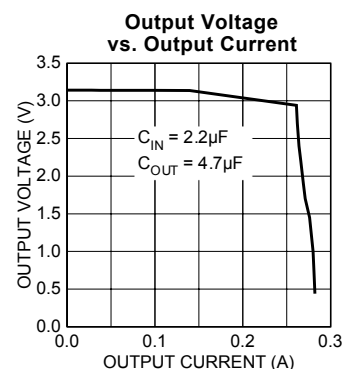
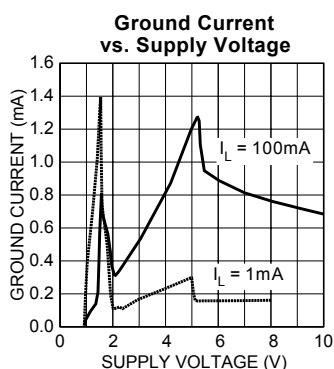
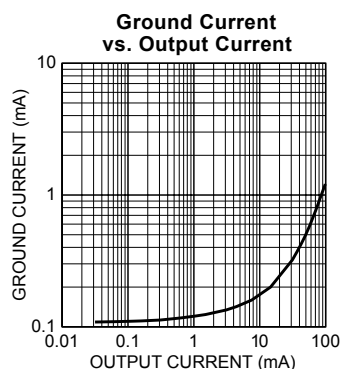
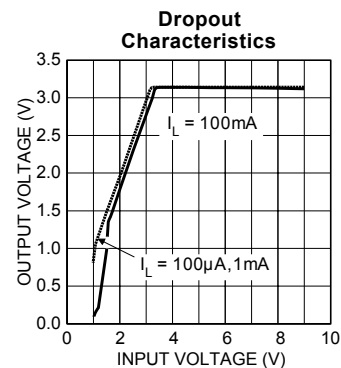
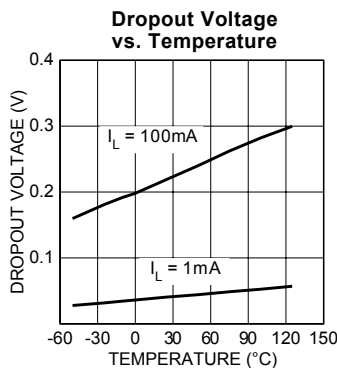
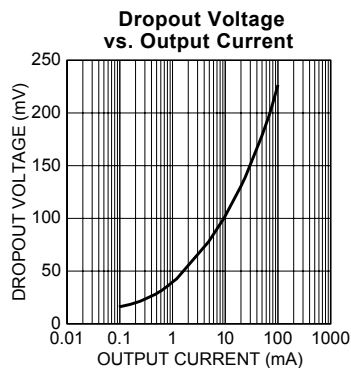

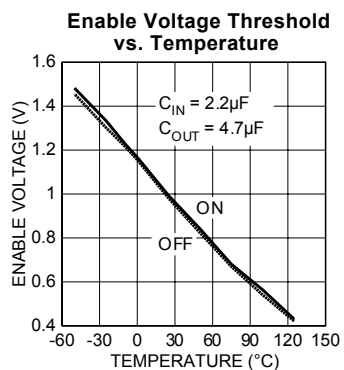
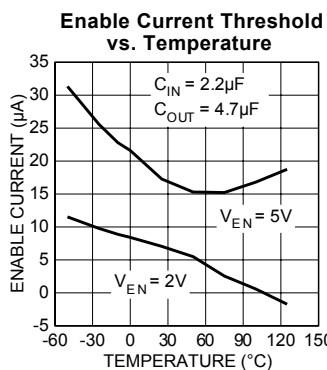
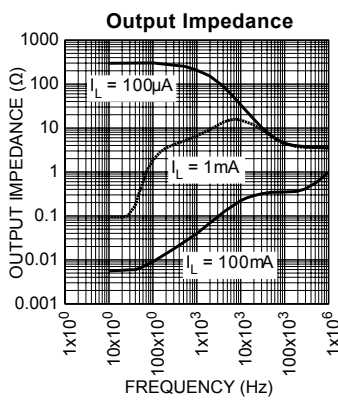
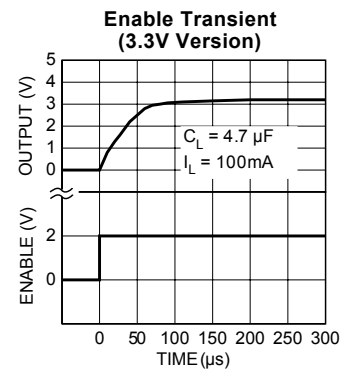
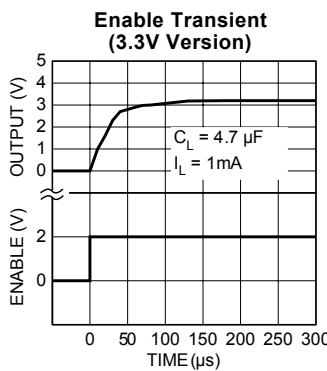
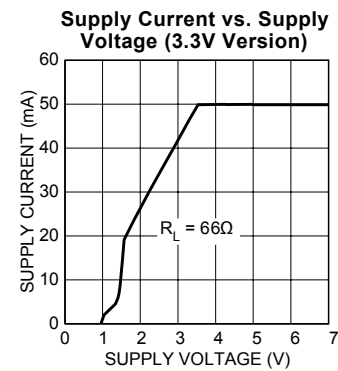
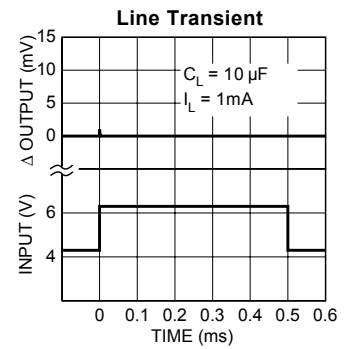
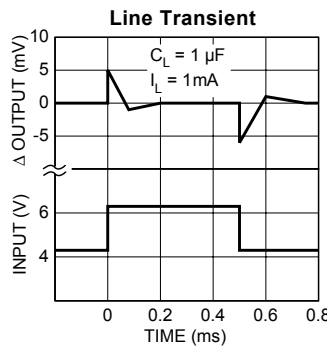
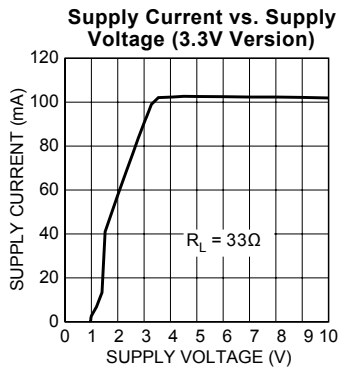
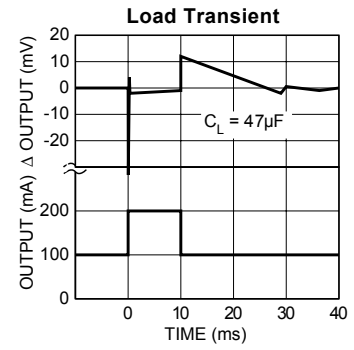
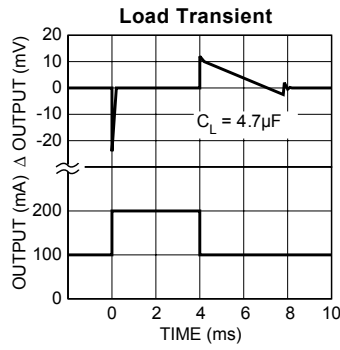
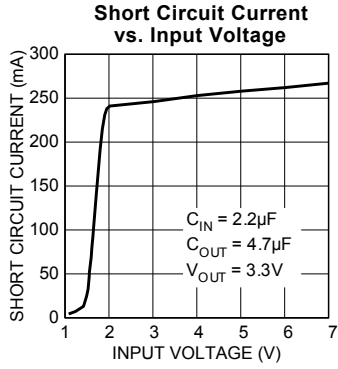

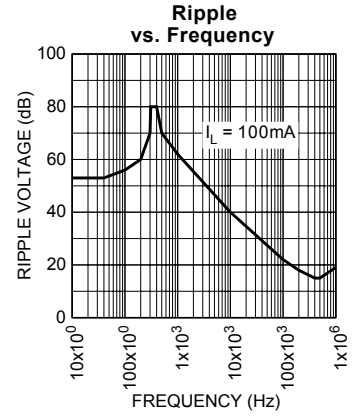
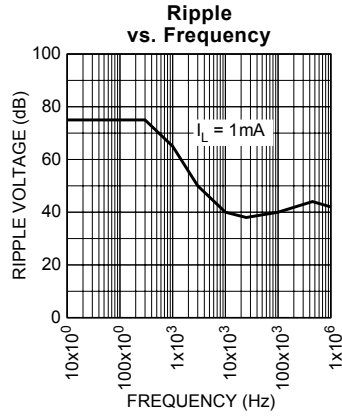
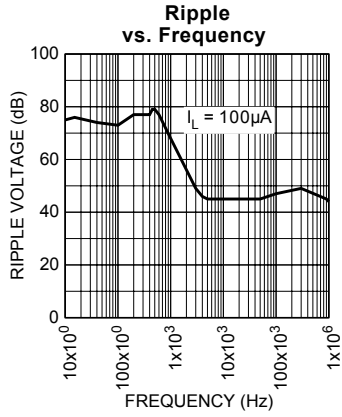

## Applications Information

### External Capacitors

A 1 $\mu$ F capacitor is recommended between the MIC5200 output and ground to prevent oscillations due to instability. Larger values serve to improve the regulator's transient response. Most types of tantalum or aluminum electrolytics will be adequate; film types will work, but are costly and therefore not recommended. Many aluminum electrolytics have electrolytes that freeze at about  $-30^{\circ}\text{C}$ , so solid tantalum capacitors are recommended for operation below  $-25^{\circ}\text{C}$ . The important parameters of the capacitor are an effective series resistance of about  $5\Omega$  or less and a resonant frequency above 500kHz. The value of this capacitor may be increased without limit.

At lower values of output current, less output capacitance is required for output stability. The capacitor can be reduced to 0.47 $\mu$ F for current below 10mA or 0.33 $\mu$ F for currents below 1 mA. A 1 $\mu$ F capacitor should be placed from the MIC5200 input to ground if there is more than 10 inches of wire between the input and the AC filter capacitor or if a battery is used as the input.

The MIC5200 will remain stable and in regulation with no load in addition to the internal voltage divider, unlike many other voltage regulators. This is especially important in CMOS RAM keep-alive applications.

When used in dual supply systems where the regulator load is returned to a negative supply, the output voltage must be diode clamped to ground.

### ENABLE Input

The MIC5200 features nearly zero OFF mode current. When the ENABLE input is held below 0.7V, all internal circuitry is powered off. Pulling this pin high (over 2.0V) re-enables the device and allows operation. The ENABLE pin requires a small amount of current, typically 15 $\mu$ A. While the logic threshold is TTL/CMOS compatible, ENABLE may be pulled as high as 30V, independent of the voltage on  $V_{\text{IN}}$ .

## Thermal Considerations

### Part I. Layout

The MIC5200-xxBM (8-pin surface mount package) has the following thermal characteristics when mounted on a single layer copper-clad printed circuit board.

PC Board Dielectric	$\theta_{\text{JA}}$
FR4	160 $^{\circ}\text{C}/\text{W}$
Ceramic	120 $^{\circ}\text{C}/\text{W}$

Multi-layer boards having a ground plane, wide traces near the pads, and large supply bus lines provide better thermal conductivity.

The "worst case" value of 160 $^{\circ}\text{C}/\text{W}$  assumes no ground plane, minimum trace widths, and a FR4 material board.

### Part II. Nominal Power Dissipation and Die Temperature

The MIC5200-xxBM at a 25 $^{\circ}\text{C}$  ambient temperature will operate reliably at up to 625mW power dissipation when mounted in the "worst case" manner described above. At an ambient temperature of 55 $^{\circ}\text{C}$ , the device may safely dissipate 440mW. These power levels are equivalent to a die temperature of 125 $^{\circ}\text{C}$ , the recommended maximum temperature for non-military grade silicon integrated circuits.

For MIC5200-xxBS (SOT-223 package) heat sink characteristics, please refer to Micrel Application Hint 17, "Calculating P.C. Board Heat Sink Area for Surface Mount Packages".

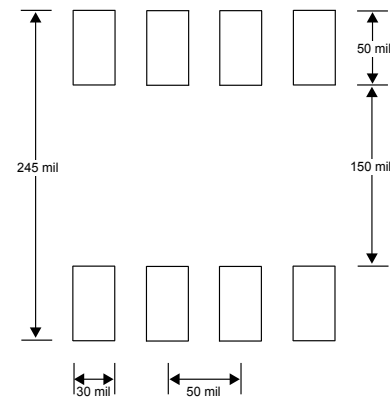

Minimum recommended board pad size, SO-8.



# Package Information

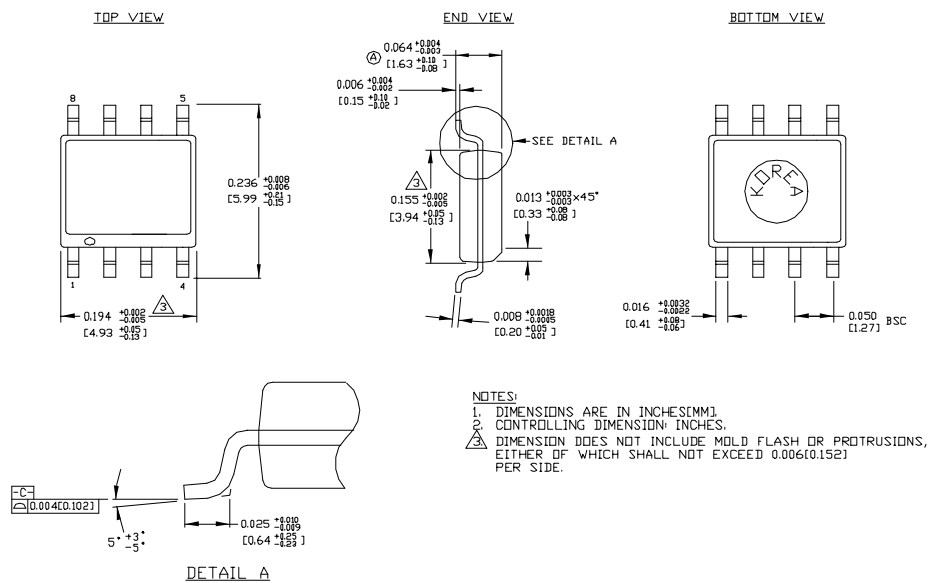

**8-Pin SOIC (M)**

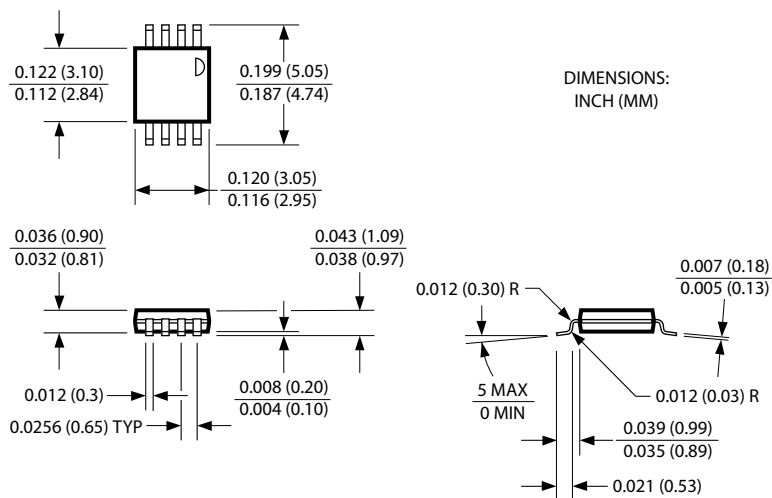

**8-Lead MSOP (MM)**

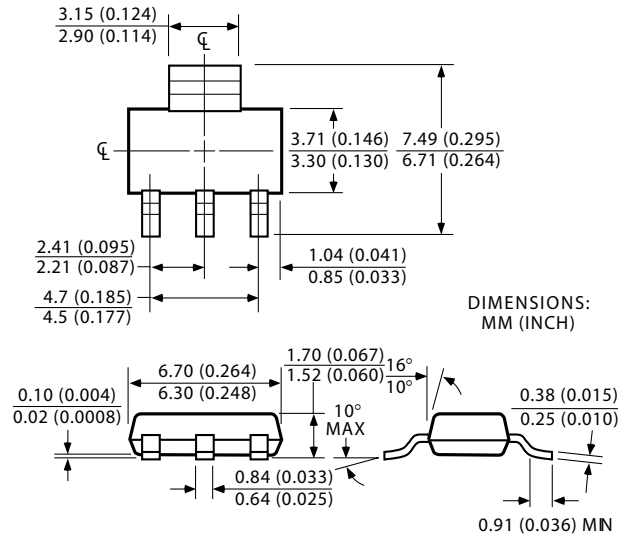
**SOT-223 (S)**

**MICREL INC. 2180 FORTUNE DRIVE SAN JOSE, CA 95131 USA**

TEL + 1 (408) 944-0800 FAX + 1 (408) 474-1000 WEB <http://www.micrel.com>

This information furnished by Micrel in this data sheet is believed to be accurate and reliable. However no responsibility is assumed by Micrel for its use. Micrel reserves the right to change circuitry and specifications at any time without notification to the customer.

Micrel Products are not designed or authorized for use as components in life support appliances, devices or systems where malfunction of a product can reasonably be expected to result in personal injury. Life support devices or systems are devices or systems that (a) are intended for surgical implant into the body or (b) support or sustain life, and whose failure to perform can be reasonably expected to result in a significant injury to the user. A Purchaser's use or sale of Micrel Products for use in life support appliances, devices or systems is a Purchaser's own risk and Purchaser agrees to fully indemnify Micrel for any damages resulting from such use or sale.

© 1998 Micrel Incorporated