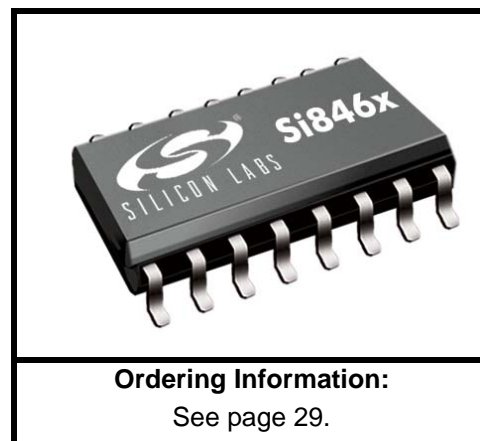


## LOW POWER SIX-CHANNEL DIGITAL ISOLATOR

### Features

- High-speed operation
  - DC to 150 Mbps
- No start-up initialization required
- Wide Operating Supply Voltage: 2.70–5.5 V
- Wide Operating Supply Voltage: 2.70–5.5V
- Ultra low power (typical) 5 V Operation:
  - < 1.6 mA per channel at 1 Mbps
  - < 6 mA per channel at 100 Mbps
- 2.70 V Operation:
  - < 1.4 mA per channel at 1 Mbps
  - < 4 mA per channel at 100 Mbps
- High electromagnetic immunity
- Up to 2500 V<sub>RMS</sub> isolation
- 60-year life at rated working voltage
- Precise timing (typical)
  - <10 ns worst case
  - 1.5 ns pulse width distortion
  - 0.5 ns channel-channel skew
  - 2 ns propagation delay skew
  - 6 ns minimum pulse width
- Transient Immunity 25 kV/μs
- Wide temperature range
  - –40 to 125 °C at 150 Mbps
- RoHS-compliant packages
  - SOIC-16 narrow body



### Applications

- Industrial automation systems
- Hybrid electric vehicles
- Isolated switch mode supplies
- Isolated ADC, DAC
- Motor control
- Power inverters
- Communications systems

### Safety Regulatory Approvals

- UL 1577 recognized
  - Up to 2500 V<sub>RMS</sub> for 1 minute
- CSA component notice 5A approval
  - IEC 60950-1, 61010-1 (reinforced insulation)
- VDE certification conformity
  - IEC 60747-5-2 (VDE0884 Part 2)

### Description

Silicon Lab's family of ultra-low-power digital isolators are CMOS devices offering substantial data rate, propagation delay, power, size, reliability, and external BOM advantages when compared to legacy isolation technologies. The operating parameters of these products remain stable across wide temperature ranges throughout their service life. For ease of design, only VDD bypass capacitors are required.

Data rates up to 150 Mbps are supported, and all devices achieve worst-case propagation delays of less than 10 ns. All products are safety certified by UL, CSA, and VDE and support withstand voltages of up to 2.5 kVrms. These devices are available in a 16-pin narrow-body SOIC package.



---

**TABLE OF CONTENTS**


---

| <b><u>Section</u></b>   | <b><u>Page</u></b> |
|---|--------------------|
| <b>1. Electrical Specifications</b> .....                             | <b>4</b>           |
| <b>2. Functional Description</b> .....                                | <b>20</b>          |
| 2.1. Theory of Operation .....  | 20                 |
| 2.2. Eye Diagram .....  | 21                 |
| 2.3. Device Operation .....   | 22                 |
| 2.4. Layout Recommendations .....                                     | 23                 |
| 2.5. Typical Performance Characteristics .....                        | 24                 |
| <b>3. Errata and Design Migration Guidelines</b> .....                | <b>27</b>          |
| 3.1. Power Supply Bypass Capacitors (Revision A and Revision B) ..... | 27                 |
| 3.2. Latch Up Immunity (Revision A Only) .....                        | 27                 |
| <b>4. Pin Descriptions</b> .....                                      | <b>28</b>          |
| <b>5. Ordering Guide</b> .....  | <b>29</b>          |
| <b>6. Package Outline: 16-Pin Narrow Body SOIC</b> .....              | <b>31</b>          |
| <b>7. Land Pattern: 16-Pin Narrow Body SOIC</b> .....                 | <b>33</b>          |
| <b>8. Top Marking: 16-Pin Narrow Body SOIC</b> .....                  | <b>34</b>          |
| 8.1. 16-Pin Narrow Body SOIC Top Marking .....                        | 34                 |
| 8.2. Top Marking Explanation .....                                    | 34                 |
| <b>Document Change List</b> .....                                     | <b>35</b>          |
| <b>Contact Information</b> .....                                      | <b>36</b>          |

# Si8460/61/62/63

## 1. Electrical Specifications

Table 1. Recommended Operating Conditions

| Parameter                      | Symbol    | Test Condition       | Min  | Typ | Max | Unit |
|--------------------------------|-----------|----------------------|------|-----|-----|------|
| Ambient Operating Temperature* | $T_A$     | 150 Mbps, 15 pF, 5 V | -40  | 25  | 125 | °C   |
| Supply Voltage                 | $V_{DD1}$ |                      | 2.70 | —   | 5.5 | V    |
|                                | $V_{DD2}$ |                      | 2.70 | —   | 5.5 | V    |

\*Note: The maximum ambient temperature is dependent on data frequency, output loading, number of operating channels, and supply voltage.

Table 2. Absolute Maximum Ratings<sup>1</sup>

| Parameter                                | Symbol             | Min  | Typ | Max            | Unit      |
|--|--------------------|------|-----|----------------|-----------|
| Storage Temperature <sup>2</sup>         | $T_{STG}$          | -65  | —   | 150            | °C        |
| Ambient Temperature Under Bias           | $T_A$              | -40  | —   | 125            | °C        |
| Supply Voltage (Revision A) <sup>3</sup> | $V_{DD1}, V_{DD2}$ | -0.5 | —   | 5.75           | V         |
| Supply Voltage (Revision B) <sup>3</sup> | $V_{DD1}, V_{DD2}$ | -0.5 | —   | 6.0            | V         |
| Input Voltage                            | $V_I$              | -0.5 | —   | $V_{DD} + 0.5$ | V         |
| Output Voltage                           | $V_O$              | -0.5 | —   | $V_{DD} + 0.5$ | V         |
| Output Current Drive Channel             | $I_O$              | —    | —   | 10             | mA        |
| Lead Solder Temperature (10 s)           |                    | —    | —   | 260            | °C        |
| Maximum Isolation Voltage (1 s)          |                    | —    | —   | 3600           | $V_{RMS}$ |

**Notes:**

1. Permanent device damage may occur if the absolute maximum ratings are exceeded. Functional operation should be restricted to conditions as specified in the operational sections of this data sheet.
2. VDE certifies storage temperature from -40 to 150 °C.
3. See "5. Ordering Guide" on page 29 for more information.

**Table 3. Electrical Characteristics**(V<sub>DD1</sub> = 5 V±10%, V<sub>DD2</sub> = 5 V±10%, T<sub>A</sub> = -40 to 125 °C; applies to narrow-body SOIC package)

| Parameter  | Symbol          | Test Condition          | Min                                       | Typ | Max  | Unit |
|--|-----------------|-------------------------|---|-----|------|------|
| High Level Input Voltage   | V <sub>IH</sub> |                         | 2.0                                       | —   | —    | V    |
| Low Level Input Voltage  | V <sub>IL</sub> |                         | —   | —   | 0.8  | V    |
| High Level Output Voltage  | V <sub>OH</sub> | I <sub>oh</sub> = -4 mA | V <sub>DD1</sub> , V <sub>DD2</sub> - 0.4 | 4.8 | —    | V    |
| Low Level Output Voltage   | V <sub>OL</sub> | I <sub>ol</sub> = 4 mA  | —   | 0.2 | 0.4  | V    |
| Input Leakage Current  | I <sub>L</sub>  |                         | —   | —   | ±10  | µA   |
| Output Impedance <sup>1</sup>  | Z <sub>O</sub>  |                         | —   | 85  | —    | Ω    |
| <b>DC Supply Current (All inputs 0 V or at Supply)</b>   |                 |                         |   |     |      |      |
| <b>Si8460Ax, Bx</b>  |                 |                         |   |     |      |      |
| V <sub>DD1</sub>   |                 | All inputs 0 DC         | —   | 1.7 | 2.6  | mA   |
| V <sub>DD2</sub>   |                 | All inputs 0 DC         | —   | 3.3 | 5.0  |      |
| V <sub>DD1</sub>   |                 | All inputs 1 DC         | —   | 7.7 | 11.6 |      |
| V <sub>DD2</sub>   |                 | All inputs 1 DC         | —   | 3.5 | 5.3  |      |
| <b>Si8461Ax, Bx</b>  |                 |                         |   |     |      |      |
| V <sub>DD1</sub>   |                 | All inputs 0 DC         | —   | 2.1 | 3.2  | mA   |
| V <sub>DD2</sub>   |                 | All inputs 0 DC         | —   | 3.4 | 5.1  |      |
| V <sub>DD1</sub>   |                 | All inputs 1 DC         | —   | 7.1 | 10.7 |      |
| V <sub>DD2</sub>   |                 | All inputs 1 DC         | —   | 4.5 | 6.8  |      |
| <b>Si8462Ax, Bx</b>  |                 |                         |   |     |      |      |
| V <sub>DD1</sub>   |                 | All inputs 0 DC         | —   | 2.5 | 3.8  | mA   |
| V <sub>DD2</sub>   |                 | All inputs 0 DC         | —   | 3.0 | 4.5  |      |
| V <sub>DD1</sub>   |                 | All inputs 1 DC         | —   | 6.5 | 9.8  |      |
| V <sub>DD2</sub>   |                 | All inputs 1 DC         | —   | 5.0 | 8.3  |      |
| <b>Si8463Ax, Bx</b>  |                 |                         |   |     |      |      |
| V <sub>DD1</sub>   |                 | All inputs 0 DC         | —   | 2.8 | 4.2  | mA   |
| V <sub>DD2</sub>   |                 | All inputs 0 DC         | —   | 2.8 | 4.2  |      |
| V <sub>DD1</sub>   |                 | All inputs 1 DC         | —   | 6.0 | 9.0  |      |
| V <sub>DD2</sub>   |                 | All inputs 1 DC         | —   | 6.0 | 9.0  |      |
| <b>Notes:</b>  |                 |                         |   |     |      |      |
| 1. The nominal output impedance of an isolator driver channel is approximately 85 Ω, ±40%, which is a combination of the value of the on-chip series termination resistor and channel resistance of the output driver FET. When driving loads where transmission line effects will be a factor, output pins should be appropriately terminated with controlled impedance PCB traces. |                 |                         |   |     |      |      |
| 2. t <sub>PSK(P-P)</sub> is the magnitude of the difference in propagation delay times measured between different units operating at the same supply voltages, load, and ambient temperature.  |                 |                         |   |     |      |      |
| 3. Start-up time is the time period from the application of power to valid data at the output.   |                 |                         |   |     |      |      |

# Si8460/61/62/63

**Table 3. Electrical Characteristics (Continued)**

( $V_{DD1} = 5 V \pm 10\%$ ,  $V_{DD2} = 5 V \pm 10\%$ ,  $T_A = -40$  to  $125$  °C; applies to narrow-body SOIC package)

| Parameter  | Symbol | Test Condition | Min | Typ | Max | Unit |
|--|--------|----------------|-----|-----|-----|------|
| <b>1 Mbps Supply Current</b> (All inputs = 500 kHz square wave, CI = 15 pF on all outputs)   |        |                |     |     |     |      |
| <b>Si8460Ax, Bx</b>  |        |                |     |     |     |      |
| $V_{DD1}$  |        |                | —   | 4.7 | 7.1 | mA   |
| $V_{DD2}$  |        |                | —   | 4.0 | 6.0 |      |
| <b>Si8461Ax, Bx</b>  |        |                |     |     |     |      |
| $V_{DD1}$  |        |                | —   | 4.7 | 7.1 | mA   |
| $V_{DD2}$  |        |                | —   | 4.5 | 6.8 |      |
| <b>Si8462Ax, Bx</b>  |        |                |     |     |     |      |
| $V_{DD1}$  |        |                | —   | 4.7 | 7.1 | mA   |
| $V_{DD2}$  |        |                | —   | 4.3 | 6.5 |      |
| <b>Si8463Ax, Bx</b>  |        |                |     |     |     |      |
| $V_{DD1}$  |        |                | —   | 4.7 | 7.1 | mA   |
| $V_{DD2}$  |        |                | —   | 4.7 | 7.1 |      |
| <b>10 Mbps Supply Current</b> (All inputs = 5 MHz square wave, CI = 15 pF on all outputs)  |        |                |     |     |     |      |
| <b>Si8460Bx</b>  |        |                |     |     |     |      |
| $V_{DD1}$  |        |                | —   | 4.7 | 7.1 | mA   |
| $V_{DD2}$  |        |                | —   | 5.5 | 7.7 |      |
| <b>Si8461Bx</b>  |        |                |     |     |     |      |
| $V_{DD1}$  |        |                | —   | 5.0 | 7.2 | mA   |
| $V_{DD2}$  |        |                | —   | 5.7 | 8   |      |
| <b>Si8462Bx</b>  |        |                |     |     |     |      |
| $V_{DD1}$  |        |                | —   | 5.2 | 7.3 | mA   |
| $V_{DD2}$  |        |                | —   | 5.4 | 7.6 |      |
| <b>Si8463Bx</b>  |        |                |     |     |     |      |
| $V_{DD1}$  |        |                | —   | 5.5 | 7.7 | mA   |
| $V_{DD2}$  |        |                | —   | 5.5 | 7.7 |      |
| <b>Notes:</b>  |        |                |     |     |     |      |
| <ol style="list-style-type: none"> <li>1. The nominal output impedance of an isolator driver channel is approximately <math>85 \Omega</math>, <math>\pm 40\%</math>, which is a combination of the value of the on-chip series termination resistor and channel resistance of the output driver FET. When driving loads where transmission line effects will be a factor, output pins should be appropriately terminated with controlled impedance PCB traces.</li> <li>2. <math>t_{PSK(P-P)}</math> is the magnitude of the difference in propagation delay times measured between different units operating at the same supply voltages, load, and ambient temperature.</li> <li>3. Start-up time is the time period from the application of power to valid data at the output.</li> </ol> |        |                |     |     |     |      |

**Table 3. Electrical Characteristics (Continued)** $(V_{DD1} = 5 V \pm 10\%, V_{DD2} = 5 V \pm 10\%, T_A = -40 \text{ to } 125 \text{ }^\circ\text{C}; \text{ applies to narrow-body SOIC package})$ 

| Parameter  | Symbol             | Test Condition | Min | Typ  | Max  | Unit |
|--|--------------------|----------------|-----|------|------|------|
| <b>100 Mbps Supply Current</b> (All inputs = 50 MHz square wave, CI = 15 pF on all outputs)  |                    |                |     |      |      |      |
| <b>Si8460Bx</b>  |                    |                |     |      |      |      |
| $V_{DD1}$  |                    |                | —   | 5.0  | 7.5  | mA   |
| $V_{DD2}$  |                    |                | —   | 28.8 | 36   |      |
| <b>Si8461Bx</b>  |                    |                |     |      |      |      |
| $V_{DD1}$  |                    |                | —   | 9.0  | 11.3 | mA   |
| $V_{DD2}$  |                    |                | —   | 25   | 30   |      |
| <b>Si8462Bx</b>  |                    |                |     |      |      |      |
| $V_{DD1}$  |                    |                | —   | 13.3 | 16.6 | mA   |
| $V_{DD2}$  |                    |                | —   | 20.8 | 26   |      |
| <b>Si8463Bx</b>  |                    |                |     |      |      |      |
| $V_{DD1}$  |                    |                | —   | 17.2 | 21.5 | mA   |
| $V_{DD2}$  |                    |                | —   | 17.2 | 21.5 |      |
| <b>Timing Characteristics</b>  |                    |                |     |      |      |      |
| <b>Si846xAx</b>  |                    |                |     |      |      |      |
| Maximum Data Rate  |                    |                | 0   | —    | 1.0  | Mbps |
| Minimum Pulse Width  |                    |                | —   | —    | 250  | ns   |
| Propagation Delay  | $t_{PHL}, t_{PLH}$ | See Figure 1   | —   | —    | 35   | ns   |
| Pulse Width Distortion<br>$ t_{PLH} - t_{PHL} $  | PWD                | See Figure 1   | —   | —    | 25   | ns   |
| Propagation Delay Skew <sup>2</sup>  | $t_{PSK(P-P)}$     |                | —   | —    | 40   | ns   |
| Channel-Channel Skew   | $t_{PSK}$          |                | —   | —    | 35   | ns   |
| <b>Si846xBx</b>  |                    |                |     |      |      |      |
| Maximum Data Rate  |                    |                | 0   | —    | 150  | Mbps |
| Minimum Pulse Width  |                    |                | —   | —    | 6.0  | ns   |
| Propagation Delay  | $t_{PHL}, t_{PLH}$ | See Figure 1   | 3.0 | 6.0  | 9.5  | ns   |
| Pulse Width Distortion<br>$ t_{PLH} - t_{PHL} $  | PWD                | See Figure 1   | —   | 1.5  | 2.5  | ns   |
| Propagation Delay Skew <sup>2</sup>  | $t_{PSK(P-P)}$     |                | —   | 2.0  | 3.0  | ns   |
| Channel-Channel Skew   | $t_{PSK}$          |                | —   | 0.5  | 1.8  | ns   |
| <b>Notes:</b>  |                    |                |     |      |      |      |
| 1. The nominal output impedance of an isolator driver channel is approximately $85 \Omega, \pm 40\%$ , which is a combination of the value of the on-chip series termination resistor and channel resistance of the output driver FET. When driving loads where transmission line effects will be a factor, output pins should be appropriately terminated with controlled impedance PCB traces. |                    |                |     |      |      |      |
| 2. $t_{PSK(P-P)}$ is the magnitude of the difference in propagation delay times measured between different units operating at the same supply voltages, load, and ambient temperature.   |                    |                |     |      |      |      |
| 3. Start-up time is the time period from the application of power to valid data at the output.   |                    |                |     |      |      |      |

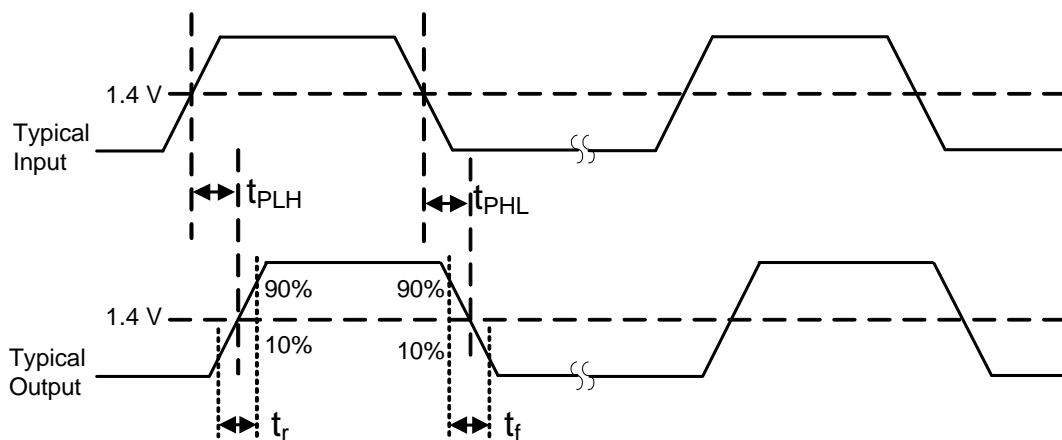
**Table 3. Electrical Characteristics (Continued)**

( $V_{DD1} = 5 V \pm 10\%$ ,  $V_{DD2} = 5 V \pm 10\%$ ,  $T_A = -40$  to  $125$  °C; applies to narrow-body SOIC package)

| Parameter                      | Symbol   | Test Condition                | Min | Typ | Max | Unit        |
|--------------------------------|----------|-------------------------------|-----|-----|-----|-------------|
| <b>All Models</b>              |          |                               |     |     |     |             |
| Output Rise Time               | $t_r$    | $C_L = 15$ pF<br>See Figure 1 | —   | 3.8 | 5.0 | ns          |
| Output Fall Time               | $t_f$    | $C_L = 15$ pF<br>See Figure 1 | —   | 2.8 | 3.7 | ns          |
| Common Mode Transient Immunity | CMTI     | $V_I = V_{DD}$ or $0$ V       | —   | 25  | —   | kV/ $\mu$ s |
| Start-up Time <sup>3</sup>     | $t_{SU}$ |                               | —   | 15  | 40  | $\mu$ s     |

**Notes:**

1. The nominal output impedance of an isolator driver channel is approximately  $85 \Omega$ ,  $\pm 40\%$ , which is a combination of the value of the on-chip series termination resistor and channel resistance of the output driver FET. When driving loads where transmission line effects will be a factor, output pins should be appropriately terminated with controlled impedance PCB traces.
2.  $t_{PSK(P-P)}$  is the magnitude of the difference in propagation delay times measured between different units operating at the same supply voltages, load, and ambient temperature.
3. Start-up time is the time period from the application of power to valid data at the output.



**Figure 1. Propagation Delay Timing**



**Table 4. Electrical Characteristics**(V<sub>DD1</sub> = 3.3 V±10%, V<sub>DD2</sub> = 3.3 V±10%, T<sub>A</sub> = -40 to 125 °C; applies to narrow-body SOIC package)

| Parameter  | Symbol          | Test Condition          | Min                                       | Typ | Max  | Unit |
|--|-----------------|-------------------------|---|-----|------|------|
| High Level Input Voltage   | V <sub>IH</sub> |                         | 2.0                                       | —   | —    | V    |
| Low Level Input Voltage  | V <sub>IL</sub> |                         | —   | —   | 0.8  | V    |
| High Level Output Voltage  | V <sub>OH</sub> | I <sub>oh</sub> = -4 mA | V <sub>DD1</sub> , V <sub>DD2</sub> - 0.4 | 3.1 | —    | V    |
| Low Level Output Voltage   | V <sub>OL</sub> | I <sub>ol</sub> = 4 mA  | —   | 0.2 | 0.4  | V    |
| Input Leakage Current  | I <sub>L</sub>  |                         | —   | —   | ±10  | µA   |
| Output Impedance <sup>1</sup>  | Z <sub>O</sub>  |                         | —   | 85  | —    | Ω    |
| <b>DC Supply Current (All inputs 0 V or at supply)</b>   |                 |                         |   |     |      |      |
| <b>Si8460Ax, Bx</b>  |                 |                         |   |     |      |      |
| V <sub>DD1</sub>   |                 | All inputs 0 DC         | —   | 1.7 | 2.6  | mA   |
| V <sub>DD2</sub>   |                 | All inputs 0 DC         | —   | 3.3 | 5.0  |      |
| V <sub>DD1</sub>   |                 | All inputs 1 DC         | —   | 7.7 | 11.6 |      |
| V <sub>DD2</sub>   |                 | All inputs 1 DC         | —   | 3.5 | 5.3  |      |
| <b>Si8461Ax, Bx</b>  |                 |                         |   |     |      |      |
| V <sub>DD1</sub>   |                 | All inputs 0 DC         | —   | 2.1 | 3.2  | mA   |
| V <sub>DD2</sub>   |                 | All inputs 0 DC         | —   | 3.4 | 5.1  |      |
| V <sub>DD1</sub>   |                 | All inputs 1 DC         | —   | 7.1 | 10.7 |      |
| V <sub>DD2</sub>   |                 | All inputs 1 DC         | —   | 4.5 | 6.8  |      |
| <b>Si8462Ax, Bx</b>  |                 |                         |   |     |      |      |
| V <sub>DD1</sub>   |                 | All inputs 0 DC         | —   | 2.5 | 3.8  | mA   |
| V <sub>DD2</sub>   |                 | All inputs 0 DC         | —   | 3.0 | 4.5  |      |
| V <sub>DD1</sub>   |                 | All inputs 1 DC         | —   | 6.5 | 9.8  |      |
| V <sub>DD2</sub>   |                 | All inputs 1 DC         | —   | 5.0 | 8.3  |      |
| <b>Si8463Ax, Bx</b>  |                 |                         |   |     |      |      |
| V <sub>DD1</sub>   |                 | All inputs 0 DC         | —   | 2.8 | 4.2  | mA   |
| V <sub>DD2</sub>   |                 | All inputs 0 DC         | —   | 2.8 | 4.2  |      |
| V <sub>DD1</sub>   |                 | All inputs 1 DC         | —   | 6.0 | 9.0  |      |
| V <sub>DD2</sub>   |                 | All inputs 1 DC         | —   | 6.0 | 9.0  |      |
| <b>Notes:</b>  |                 |                         |   |     |      |      |
| 1. The nominal output impedance of an isolator driver channel is approximately 85 Ω, ±40%, which is a combination of the value of the on-chip series termination resistor and channel resistance of the output driver FET. When driving loads where transmission line effects will be a factor, output pins should be appropriately terminated with controlled impedance PCB traces. |                 |                         |   |     |      |      |
| 2. t <sub>PSK(P-P)</sub> is the magnitude of the difference in propagation delay times measured between different units operating at the same supply voltages, load, and ambient temperature.  |                 |                         |   |     |      |      |
| 3. Start-up time is the time period from the application of power to valid data at the output.   |                 |                         |   |     |      |      |

# Si8460/61/62/63

**Table 4. Electrical Characteristics (Continued)**

( $V_{DD1} = 3.3 V \pm 10\%$ ,  $V_{DD2} = 3.3 V \pm 10\%$ ,  $T_A = -40$  to  $125$  °C; applies to narrow-body SOIC package)

| Parameter  | Symbol | Test Condition | Min | Typ | Max | Unit |
|--|--------|----------------|-----|-----|-----|------|
| <b>1 Mbps Supply Current</b> (All inputs = 500 kHz square wave, CI = 15 pF on all outputs)   |        |                |     |     |     |      |
| <b>Si8460Ax, Bx</b>  |        |                |     |     |     |      |
| $V_{DD1}$  |        |                | —   | 4.7 | 7.1 | mA   |
| $V_{DD2}$  |        |                | —   | 4.0 | 6.0 |      |
| <b>Si8461Ax, Bx</b>  |        |                |     |     |     |      |
| $V_{DD1}$  |        |                | —   | 4.7 | 7.1 | mA   |
| $V_{DD2}$  |        |                | —   | 4.5 | 6.8 |      |
| <b>Si8462Ax, Bx</b>  |        |                |     |     |     |      |
| $V_{DD1}$  |        |                | —   | 4.7 | 7.1 | mA   |
| $V_{DD2}$  |        |                | —   | 4.3 | 6.5 |      |
| <b>Si8463Ax, Bx</b>  |        |                |     |     |     |      |
| $V_{DD1}$  |        |                | —   | 4.7 | 7.1 | mA   |
| $V_{DD2}$  |        |                | —   | 4.7 | 7.1 |      |
| <b>10 Mbps Supply Current</b> (All inputs = 5 MHz square wave, CI = 15 pF on all outputs)  |        |                |     |     |     |      |
| <b>Si8460Bx</b>  |        |                |     |     |     |      |
| $V_{DD1}$  |        |                | —   | 4.7 | 7.1 | mA   |
| $V_{DD2}$  |        |                | —   | 5.5 | 7.7 |      |
| <b>Si8461Bx</b>  |        |                |     |     |     |      |
| $V_{DD1}$  |        |                | —   | 5.0 | 7.2 | mA   |
| $V_{DD2}$  |        |                | —   | 5.7 | 8.0 |      |
| <b>Si8462Bx</b>  |        |                |     |     |     |      |
| $V_{DD1}$  |        |                | —   | 5.2 | 7.3 | mA   |
| $V_{DD2}$  |        |                | —   | 5.4 | 7.6 |      |
| <b>Si8463Bx</b>  |        |                |     |     |     |      |
| $V_{DD1}$  |        |                | —   | 5.5 | 7.7 | mA   |
| $V_{DD2}$  |        |                | —   | 5.5 | 7.7 |      |
| <b>Notes:</b>  |        |                |     |     |     |      |
| <ol style="list-style-type: none"> <li>1. The nominal output impedance of an isolator driver channel is approximately <math>85 \Omega</math>, <math>\pm 40\%</math>, which is a combination of the value of the on-chip series termination resistor and channel resistance of the output driver FET. When driving loads where transmission line effects will be a factor, output pins should be appropriately terminated with controlled impedance PCB traces.</li> <li>2. <math>t_{PSK(P-P)}</math> is the magnitude of the difference in propagation delay times measured between different units operating at the same supply voltages, load, and ambient temperature.</li> <li>3. Start-up time is the time period from the application of power to valid data at the output.</li> </ol> |        |                |     |     |     |      |

**Table 4. Electrical Characteristics (Continued)**(V<sub>DD1</sub> = 3.3 V±10%, V<sub>DD2</sub> = 3.3 V±10%, T<sub>A</sub> = -40 to 125 °C; applies to narrow-body SOIC package)

| Parameter  | Symbol                              | Test Condition | Min | Typ  | Max  | Unit |
|--|-------------------------------------|----------------|-----|------|------|------|
| <b>100 Mbps Supply Current</b> (All inputs = 50 MHz square wave, CI = 15 pF on all outputs)  |                                     |                |     |      |      |      |
| <b>Si8460Bx</b>  |                                     |                |     |      |      |      |
| V <sub>DD1</sub>   |                                     |                | —   | 4.8  | 7.2  | mA   |
| V <sub>DD2</sub>   |                                     |                | —   | 20   | 25   |      |
| <b>Si8461Bx</b>  |                                     |                |     |      |      |      |
| V <sub>DD1</sub>   |                                     |                | —   | 7.4  | 9.3  | mA   |
| V <sub>DD2</sub>   |                                     |                | —   | 17.7 | 22.1 |      |
| <b>Si8462Bx</b>  |                                     |                |     |      |      |      |
| V <sub>DD1</sub>   |                                     |                | —   | 10.2 | 12.8 | mA   |
| V <sub>DD2</sub>   |                                     |                | —   | 15   | 18.8 |      |
| <b>Si8463Bx</b>  |                                     |                |     |      |      |      |
| V <sub>DD1</sub>   |                                     |                | —   | 12.7 | 15.9 | mA   |
| V <sub>DD2</sub>   |                                     |                | —   | 12.7 | 15.9 |      |
| <b>Timing Characteristics</b>  |                                     |                |     |      |      |      |
| <b>Si846xAx</b>  |                                     |                |     |      |      |      |
| Maximum Data Rate  |                                     |                | 0   | —    | 1.0  | Mbps |
| Minimum Pulse Width  |                                     |                | —   | —    | 250  | ns   |
| Propagation Delay  | t <sub>PHL</sub> , t <sub>PLH</sub> | See Figure 1   | —   | —    | 35   | ns   |
| Pulse Width Distortion<br> t <sub>PLH</sub> - t <sub>PHL</sub>   | PWD                                 | See Figure 1   | —   | —    | 25   | ns   |
| Propagation Delay Skew <sup>2</sup>  | t <sub>PSK(P-P)</sub>               |                | —   | —    | 40   | ns   |
| Channel-Channel Skew   | t <sub>PSK</sub>                    |                | —   | —    | 35   | ns   |
| <b>Si846xBx</b>  |                                     |                |     |      |      |      |
| Maximum Data Rate  |                                     |                | 0   | —    | 150  | Mbps |
| Minimum Pulse Width  |                                     |                | —   | —    | 6.0  | ns   |
| Propagation Delay  | t <sub>PHL</sub> , t <sub>PLH</sub> | See Figure 1   | 3.0 | 6.0  | 9.5  | ns   |
| Pulse Width Distortion<br> t <sub>PLH</sub> - t <sub>PHL</sub>   | PWD                                 | See Figure 1   | —   | 1.5  | 2.5  | ns   |
| Propagation Delay Skew <sup>2</sup>  | t <sub>PSK(P-P)</sub>               |                | —   | 2.0  | 3.0  | ns   |
| Channel-Channel Skew   | t <sub>PSK</sub>                    |                | —   | 0.5  | 1.8  | ns   |
| <b>Notes:</b>  |                                     |                |     |      |      |      |
| 1. The nominal output impedance of an isolator driver channel is approximately 85 Ω, ±40%, which is a combination of the value of the on-chip series termination resistor and channel resistance of the output driver FET. When driving loads where transmission line effects will be a factor, output pins should be appropriately terminated with controlled impedance PCB traces. |                                     |                |     |      |      |      |
| 2. t <sub>PSK(P-P)</sub> is the magnitude of the difference in propagation delay times measured between different units operating at the same supply voltages, load, and ambient temperature.  |                                     |                |     |      |      |      |
| 3. Start-up time is the time period from the application of power to valid data at the output.   |                                     |                |     |      |      |      |

# Si8460/61/62/63

**Table 4. Electrical Characteristics (Continued)**

( $V_{DD1} = 3.3\text{ V} \pm 10\%$ ,  $V_{DD2} = 3.3\text{ V} \pm 10\%$ ,  $T_A = -40\text{ to }125\text{ }^\circ\text{C}$ ; applies to narrow-body SOIC package)

| Parameter  | Symbol   | Test Condition                       | Min | Typ | Max | Unit              |
|--|----------|--------------------------------------|-----|-----|-----|-------------------|
| <b>All Models</b>                                  |          |                                      |     |     |     |                   |
| Output Rise Time                                   | $t_r$    | $C_L = 15\text{ pF}$<br>See Figure 1 | —   | 4.3 | 6.1 | ns                |
| Output Fall Time                                   | $t_f$    | $C_L = 15\text{ pF}$<br>See Figure 1 | —   | 3.0 | 4.3 | ns                |
| Common Mode Transient Immunity at Logic Low Output | CMTI     | $V_I = V_{DD}$ or 0 V                | —   | 25  | —   | kV/ $\mu\text{s}$ |
| Start-up Time <sup>3</sup>                         | $t_{SU}$ |                                      | —   | 15  | 40  | $\mu\text{s}$     |

**Notes:**

1. The nominal output impedance of an isolator driver channel is approximately  $85\ \Omega$ ,  $\pm 40\%$ , which is a combination of the value of the on-chip series termination resistor and channel resistance of the output driver FET. When driving loads where transmission line effects will be a factor, output pins should be appropriately terminated with controlled impedance PCB traces.
2.  $t_{PSK(P-P)}$  is the magnitude of the difference in propagation delay times measured between different units operating at the same supply voltages, load, and ambient temperature.
3. Start-up time is the time period from the application of power to valid data at the output.

**Table 5. Electrical Characteristics<sup>1</sup>**(V<sub>DD1</sub> = 2.70 V, V<sub>DD2</sub> = 2.70 V, T<sub>A</sub> = -40 to 125 °C; applies to narrow-body SOIC package)

| Parameter  | Symbol          | Test Condition          | Min                                       | Typ | Max  | Unit |
|--|-----------------|-------------------------|---|-----|------|------|
| High Level Input Voltage   | V <sub>IH</sub> |                         | 2.0                                       | —   | —    | V    |
| Low Level Input Voltage  | V <sub>IL</sub> |                         | —   | —   | 0.8  | V    |
| High Level Output Voltage  | V <sub>OH</sub> | I <sub>oh</sub> = -4 mA | V <sub>DD1</sub> , V <sub>DD2</sub> - 0.4 | 2.3 | —    | V    |
| Low Level Output Voltage   | V <sub>OL</sub> | I <sub>ol</sub> = 4 mA  | —   | 0.2 | 0.4  | V    |
| Input Leakage Current  | I <sub>L</sub>  |                         | —   | —   | ±10  | μA   |
| Output Impedance <sup>2</sup>  | Z <sub>O</sub>  |                         | —   | 85  | —    | Ω    |
| <b>DC Supply Current (All inputs 0 V or at supply)</b>   |                 |                         |   |     |      |      |
| <b>Si8460Ax, Bx</b>  |                 |                         |   |     |      |      |
| V <sub>DD1</sub>   |                 | All inputs 0 DC         | —   | 1.7 | 2.6  | mA   |
| V <sub>DD2</sub>   |                 | All inputs 0 DC         | —   | 3.3 | 5.0  |      |
| V <sub>DD1</sub>   |                 | All inputs 1 DC         | —   | 7.7 | 11.6 |      |
| V <sub>DD2</sub>   |                 | All inputs 1 DC         | —   | 3.5 | 5.3  |      |
| <b>Si8461Ax, Bx</b>  |                 |                         |   |     |      |      |
| V <sub>DD1</sub>   |                 | All inputs 0 DC         | —   | 2.1 | 3.2  | mA   |
| V <sub>DD2</sub>   |                 | All inputs 0 DC         | —   | 3.4 | 5.1  |      |
| V <sub>DD1</sub>   |                 | All inputs 1 DC         | —   | 7.1 | 10.7 |      |
| V <sub>DD2</sub>   |                 | All inputs 1 DC         | —   | 4.5 | 6.8  |      |
| <b>Si8462Ax, Bx</b>  |                 |                         |   |     |      |      |
| V <sub>DD1</sub>   |                 | All inputs 0 DC         | —   | 2.5 | 3.8  | mA   |
| V <sub>DD2</sub>   |                 | All inputs 0 DC         | —   | 3.0 | 4.5  |      |
| V <sub>DD1</sub>   |                 | All inputs 1 DC         | —   | 6.5 | 9.8  |      |
| V <sub>DD2</sub>   |                 | All inputs 1 DC         | —   | 5.0 | 8.3  |      |
| <b>Si8463Ax, Bx</b>  |                 |                         |   |     |      |      |
| V <sub>DD1</sub>   |                 | All inputs 0 DC         | —   | 2.8 | 4.2  | mA   |
| V <sub>DD2</sub>   |                 | All inputs 0 DC         | —   | 2.8 | 4.2  |      |
| V <sub>DD1</sub>   |                 | All inputs 1 DC         | —   | 6.0 | 9.0  |      |
| V <sub>DD2</sub>   |                 | All inputs 1 DC         | —   | 6.0 | 9.0  |      |
| <b>Notes:</b>  |                 |                         |   |     |      |      |
| 1. Specifications in this table are also valid at V <sub>DD1</sub> = 2.6 V and V <sub>DD2</sub> = 2.6 V when the operating temperature range is constrained to T <sub>A</sub> = 0 to 85 °C.  |                 |                         |   |     |      |      |
| 2. The nominal output impedance of an isolator driver channel is approximately 85 Ω, ±40%, which is a combination of the value of the on-chip series termination resistor and channel resistance of the output driver FET. When driving loads where transmission line effects will be a factor, output pins should be appropriately terminated with controlled impedance PCB traces. |                 |                         |   |     |      |      |
| 3. t <sub>PSK(P-P)</sub> is the magnitude of the difference in propagation delay times measured between different units operating at the same supply voltages, load, and ambient temperature.  |                 |                         |   |     |      |      |
| 4. Start-up time is the time period from the application of power to valid data at the output.   |                 |                         |   |     |      |      |

# Si8460/61/62/63

**Table 5. Electrical Characteristics<sup>1</sup> (Continued)**

( $V_{DD1} = 2.70\text{ V}$ ,  $V_{DD2} = 2.70\text{ V}$ ,  $T_A = -40\text{ to }125\text{ }^\circ\text{C}$ ; applies to narrow-body SOIC package)

| Parameter  | Symbol | Test Condition | Min | Typ | Max | Unit |
|--|--------|----------------|-----|-----|-----|------|
| <b>1 Mbps Supply Current</b> (All inputs = 500 kHz square wave, CI = 15 pF on all outputs)   |        |                |     |     |     |      |
| <b>Si8460Ax, Bx</b>  |        |                |     |     |     |      |
| $V_{DD1}$  |        |                | —   | 4.7 | 7.1 | mA   |
| $V_{DD2}$  |        |                | —   | 4.0 | 6.0 |      |
| <b>Si8461Ax, Bx</b>  |        |                |     |     |     |      |
| $V_{DD1}$  |        |                | —   | 4.7 | 7.1 | mA   |
| $V_{DD2}$  |        |                | —   | 4.5 | 6.8 |      |
| <b>Si8462Ax, Bx</b>  |        |                |     |     |     |      |
| $V_{DD1}$  |        |                | —   | 4.7 | 7.1 | mA   |
| $V_{DD2}$  |        |                | —   | 4.3 | 6.5 |      |
| <b>Si8463Ax, Bx</b>  |        |                |     |     |     |      |
| $V_{DD1}$  |        |                | —   | 4.7 | 7.1 | mA   |
| $V_{DD2}$  |        |                | —   | 4.7 | 7.1 |      |
| <b>10 Mbps Supply Current</b> (All inputs = 5 MHz square wave, CI = 15 pF on all outputs)  |        |                |     |     |     |      |
| <b>Si8460Bx</b>  |        |                |     |     |     |      |
| $V_{DD1}$  |        |                | —   | 4.7 | 7.1 | mA   |
| $V_{DD2}$  |        |                | —   | 5.5 | 7.7 |      |
| <b>Si8461Bx</b>  |        |                |     |     |     |      |
| $V_{DD1}$  |        |                | —   | 5.0 | 7.2 | mA   |
| $V_{DD2}$  |        |                | —   | 5.7 | 8.0 |      |
| <b>Si8462Bx</b>  |        |                |     |     |     |      |
| $V_{DD1}$  |        |                | —   | 5.2 | 7.3 | mA   |
| $V_{DD2}$  |        |                | —   | 5.4 | 7.6 |      |
| <b>Si8463Bx</b>  |        |                |     |     |     |      |
| $V_{DD1}$  |        |                | —   | 5.5 | 7.7 | mA   |
| $V_{DD2}$  |        |                | —   | 5.5 | 7.7 |      |
| <b>Notes:</b>  |        |                |     |     |     |      |
| <ol style="list-style-type: none"> <li>Specifications in this table are also valid at <math>V_{DD1} = 2.6\text{ V}</math> and <math>V_{DD2} = 2.6\text{ V}</math> when the operating temperature range is constrained to <math>T_A = 0\text{ to }85\text{ }^\circ\text{C}</math>.</li> <li>The nominal output impedance of an isolator driver channel is approximately <math>85\ \Omega</math>, <math>\pm 40\%</math>, which is a combination of the value of the on-chip series termination resistor and channel resistance of the output driver FET. When driving loads where transmission line effects will be a factor, output pins should be appropriately terminated with controlled impedance PCB traces.</li> <li><math>t_{PSK(P-P)}</math> is the magnitude of the difference in propagation delay times measured between different units operating at the same supply voltages, load, and ambient temperature.</li> <li>Start-up time is the time period from the application of power to valid data at the output.</li> </ol> |        |                |     |     |     |      |

**Table 5. Electrical Characteristics<sup>1</sup> (Continued)**(V<sub>DD1</sub> = 2.70 V, V<sub>DD2</sub> = 2.70 V, T<sub>A</sub> = -40 to 125 °C; applies to narrow-body SOIC package)

| Parameter  | Symbol                              | Test Condition | Min | Typ  | Max  | Unit |
|--|-------------------------------------|----------------|-----|------|------|------|
| <b>100 Mbps Supply Current</b> (All inputs = 50 MHz square wave, CI = 15 pF on all outputs)  |                                     |                |     |      |      |      |
| <b>Si8460Bx</b>  |                                     |                |     |      |      |      |
| V <sub>DD1</sub>   |                                     |                | —   | 4.8  | 7.2  | mA   |
| V <sub>DD2</sub>   |                                     |                | —   | 15.8 | 19.8 |      |
| <b>Si8461Bx</b>  |                                     |                |     |      |      |      |
| V <sub>DD1</sub>   |                                     |                | —   | 6.7  | 8.4  | mA   |
| V <sub>DD2</sub>   |                                     |                | —   | 14.2 | 17.8 |      |
| <b>Si8462Bx</b>  |                                     |                |     |      |      |      |
| V <sub>DD1</sub>   |                                     |                | —   | 8.7  | 10.9 | mA   |
| V <sub>DD2</sub>   |                                     |                | —   | 12.2 | 15.3 |      |
| <b>Si8463Bx</b>  |                                     |                |     |      |      |      |
| V <sub>DD1</sub>   |                                     |                | —   | 10.5 | 13.1 | mA   |
| V <sub>DD2</sub>   |                                     |                | —   | 10.5 | 13.1 |      |
| <b>Timing Characteristics</b>  |                                     |                |     |      |      |      |
| <b>Si846xAx</b>  |                                     |                |     |      |      |      |
| Maximum Data Rate  |                                     |                | 0   | —    | 1.0  | Mbps |
| Minimum Pulse Width  |                                     |                | —   | —    | 250  | ns   |
| Propagation Delay  | t <sub>PHL</sub> , t <sub>PLH</sub> | See Figure 1   | —   | —    | 35   | ns   |
| Pulse Width Distortion<br> t <sub>PLH</sub> - t <sub>PHL</sub>   | PWD                                 | See Figure 1   | —   | —    | 25   | ns   |
| Propagation Delay Skew <sup>3</sup>  | t <sub>PSK(P-P)</sub>               |                | —   | —    | 40   | ns   |
| Channel-Channel Skew   | t <sub>PSK</sub>                    |                | —   | —    | 35   | ns   |
| <b>Si846xBx</b>  |                                     |                |     |      |      |      |
| Maximum Data Rate  |                                     |                | 0   | —    | 150  | Mbps |
| Minimum Pulse Width  |                                     |                | —   | —    | 6.0  | ns   |
| Propagation Delay  | t <sub>PHL</sub> , t <sub>PLH</sub> | See Figure 1   | 3.0 | 6.0  | 9.5  | ns   |
| Pulse Width Distortion<br> t <sub>PLH</sub> - t <sub>PHL</sub>   | PWD                                 | See Figure 1   | —   | 1.5  | 2.5  | ns   |
| Propagation Delay Skew <sup>3</sup>  | t <sub>PSK(P-P)</sub>               |                | —   | 2.0  | 3.0  | ns   |
| Channel-Channel Skew   | t <sub>PSK</sub>                    |                | —   | 0.5  | 1.8  | ns   |
| <b>Notes:</b>  |                                     |                |     |      |      |      |
| 1. Specifications in this table are also valid at V <sub>DD1</sub> = 2.6 V and V <sub>DD2</sub> = 2.6 V when the operating temperature range is constrained to T <sub>A</sub> = 0 to 85 °C.  |                                     |                |     |      |      |      |
| 2. The nominal output impedance of an isolator driver channel is approximately 85 Ω, ±40%, which is a combination of the value of the on-chip series termination resistor and channel resistance of the output driver FET. When driving loads where transmission line effects will be a factor, output pins should be appropriately terminated with controlled impedance PCB traces. |                                     |                |     |      |      |      |
| 3. t <sub>PSK(P-P)</sub> is the magnitude of the difference in propagation delay times measured between different units operating at the same supply voltages, load, and ambient temperature.  |                                     |                |     |      |      |      |
| 4. Start-up time is the time period from the application of power to valid data at the output.   |                                     |                |     |      |      |      |

# Si8460/61/62/63

**Table 5. Electrical Characteristics<sup>1</sup> (Continued)**

(V<sub>DD1</sub> = 2.70 V, V<sub>DD2</sub> = 2.70 V, T<sub>A</sub> = -40 to 125 °C; applies to narrow-body SOIC package)

| Parameter  | Symbol          | Test Condition                          | Min | Typ | Max | Unit  |
|--|-----------------|---|-----|-----|-----|-------|
| <b>All Models</b>                                  |                 |   |     |     |     |       |
| Output Rise Time                                   | t <sub>r</sub>  | C <sub>L</sub> = 15 pF<br>See Figure 1  | —   | 4.8 | 6.5 | ns    |
| Output Fall Time                                   | t <sub>f</sub>  | C <sub>L</sub> = 15 pF<br>See Figure 1  | —   | 3.2 | 4.6 | ns    |
| Common Mode Transient Immunity at Logic Low Output | CMTI            | V <sub>I</sub> = V <sub>DD</sub> or 0 V | —   | 25  | —   | kV/μs |
| Start-up Time <sup>4</sup>                         | t <sub>SU</sub> |   | —   | 15  | 40  | μs    |

**Notes:**

- Specifications in this table are also valid at VDD1 = 2.6 V and VDD2 = 2.6 V when the operating temperature range is constrained to T<sub>A</sub> = 0 to 85 °C.
- The nominal output impedance of an isolator driver channel is approximately 85 Ω, ±40%, which is a combination of the value of the on-chip series termination resistor and channel resistance of the output driver FET. When driving loads where transmission line effects will be a factor, output pins should be appropriately terminated with controlled impedance PCB traces.
- t<sub>PSK(P-P)</sub> is the magnitude of the difference in propagation delay times measured between different units operating at the same supply voltages, load, and ambient temperature.
- Start-up time is the time period from the application of power to valid data at the output.

**Table 6. Regulatory Information\***

|  |
|--|
| <b>CSA</b>   |
| The Si84xx is certified under CSA Component Acceptance Notice 5A. For more details, see File 232873.   |
| 61010-1: Up to 300 V <sub>RMS</sub> reinforced insulation working voltage; up to 600 V <sub>RMS</sub> basic insulation working voltage.  |
| 60950-1: Up to 130 V <sub>RMS</sub> reinforced insulation working voltage; up to 600 V <sub>RMS</sub> basic insulation working voltage.  |
| <b>VDE</b>   |
| The Si84xx is certified according to IEC 60747-5-2. For more details, see File 5006301-4880-0001.  |
| 60747-5-2: Up to 560 V <sub>peak</sub> for basic insulation working voltage.   |
| <b>UL</b>  |
| The Si84xx is certified under UL1577 component recognition program. For more details, see File E257455.  |
| Rated up to 2500 V <sub>RMS</sub> isolation voltage for basic insulation.  |
| <b>*Note:</b> Regulatory Certifications apply to 2.5 kV <sub>RMS</sub> rated devices which are production tested to 3.0 kV <sub>RMS</sub> for 1 sec. For more information, see "5. Ordering Guide" on page 29. |



Table 7. Insulation and Safety-Related Specifications

| Parameter   | Symbol          | Test Condition | Value            | Unit             |
|---|-----------------|----------------|------------------|------------------|
|   |                 |                | NB SOIC-16       |                  |
| Nominal Air Gap (Clearance) <sup>1</sup>          | L(IO1)          |                | 3.9 min          | mm               |
| Nominal External Tracking (Creepage) <sup>1</sup> | L(IO2)          |                | 3.9 min          | mm               |
| Minimum Internal Gap (Internal Clearance)         |                 |                | 0.008            | mm               |
| Tracking Resistance<br>(Proof Tracking Index)     | PTI             | IEC60112       | 600              | V <sub>RMS</sub> |
| Erosion Depth                                     | ED              |                | 0.019            | mm               |
| Resistance (Input-Output) <sup>2</sup>            | R <sub>IO</sub> |                | 10 <sup>12</sup> | Ω                |
| Capacitance (Input-Output) <sup>2</sup>           | C <sub>IO</sub> | f = 1 MHz      | 2.0              | pF               |
| Input Capacitance <sup>3</sup>                    | C <sub>I</sub>  |                | 4.0              | pF               |

**Notes:**

- The values in this table correspond to the nominal creepage and clearance values as detailed in “6. Package Outline: 16-Pin Narrow Body SOIC”. VDE certifies the clearance and creepage limits as 4.7 mm minimum for the NB SOIC-16 package. UL does not impose a clearance and creepage minimum for component level certifications. CSA certifies the clearance and creepage limits as 3.9 mm minimum for the NB SOIC-16 package.
- To determine resistance and capacitance, the Si84xx is converted into a 2-terminal device. Pins 1–8 are shorted together to form the first terminal and pins 9–16 are shorted together to form the second terminal. The parameters are then measured between these two terminals.
- Measured from input pin to ground.

Table 8. IEC 60664-1 (VDE 0844 Part 2) Ratings

| Parameter                   | Test Conditions                         | Specification |
|-----------------------------|---|---------------|
| Basic Isolation Group       | Material Group                          | I             |
| Installation Classification | Rated Mains Voltages $\leq 150 V_{RMS}$ | I-IV          |
|                             | Rated Mains Voltages $\leq 300 V_{RMS}$ | I-III         |
|                             | Rated Mains Voltages $\leq 400 V_{RMS}$ | I-II          |
|                             | Rated Mains Voltages $\leq 600 V_{RMS}$ | I-II          |

**Table 9. IEC 60747-5-2 Insulation Characteristics for Si84xxxB\***

| Parameter   | Symbol     | Test Condition   | Characteristic | Unit     |
|---|------------|--|----------------|----------|
| Maximum Working Insulation Voltage                | $V_{IORM}$ |  | 560            | V peak   |
| Input to Output Test Voltage                      | $V_{PR}$   | Method b1<br>( $V_{IORM} \times 1.875 = V_{PR}$ , 100%<br>Production Test, $t_m = 1$ sec,<br>Partial Discharge < 5 pC) | 1050           | V peak   |
| Transient Overvoltage                             | $V_{IOTM}$ | $t = 60$ sec   | 4000           | V peak   |
| Pollution Degree (DIN VDE 0110, Table 1)          |            |  | 2              |          |
| Insulation Resistance at $T_S$ , $V_{IO} = 500$ V | $R_S$      |  | $>10^9$        | $\Omega$ |

**\*Note:** Maintenance of the safety data is ensured by protective circuits. The Si84xx provides a climate classification of 40/125/21.

**Table 10. IEC Safety Limiting Values<sup>1</sup>**

| Parameter                               | Symbol | Test Condition   | Min | Typ | Max        | Unit |
|---|--------|--|-----|-----|------------|------|
|   |        |  |     |     | NB SOIC-16 |      |
| Case Temperature                        | $T_S$  |  | —   | —   | 150        | °C   |
| Safety input, output, or supply current | $I_S$  | $\theta_{JA} = 105$ °C/W (NB SOIC-16),<br>$V_I = 5.5$ V, $T_J = 150$ °C, $T_A = 25$ °C | —   | —   | 215        | mA   |
| Device Power Dissipation <sup>2</sup>   | $P_D$  |  | —   | —   | 415        | mW   |

**Notes:**

- Maximum value allowed in the event of a failure; also see the thermal derating curve in Figure 2.
- The Si846x is tested with  $VDD1 = VDD2 = 5.5$  V,  $T_J = 150$  °C,  $CL = 15$  pF, input a 150 Mbps 50% duty cycle square wave.

Table 11. Thermal Characteristics

| Parameter                             | Symbol        | Test Condition | Min | Typ        | Max | Unit                        |
|---------------------------------------|---------------|----------------|-----|------------|-----|-----------------------------|
|                                       |               |                |     | NB SOIC-16 |     |                             |
| IC Junction-to-Air Thermal Resistance | $\theta_{JA}$ |                | —   | 105        | —   | $^{\circ}\text{C}/\text{W}$ |

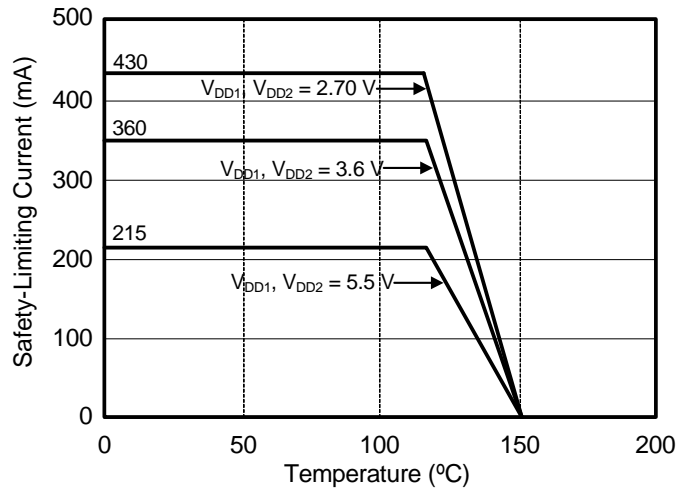
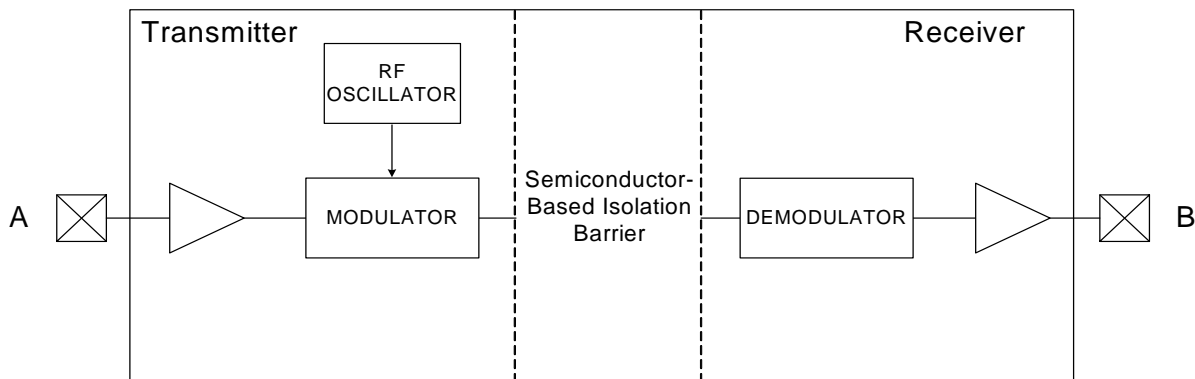


Figure 2. (NB SOIC-16) Thermal Derating Curve, Dependence of Safety Limiting Values with Case Temperature per DIN EN 60747-5-2

## 2. Functional Description

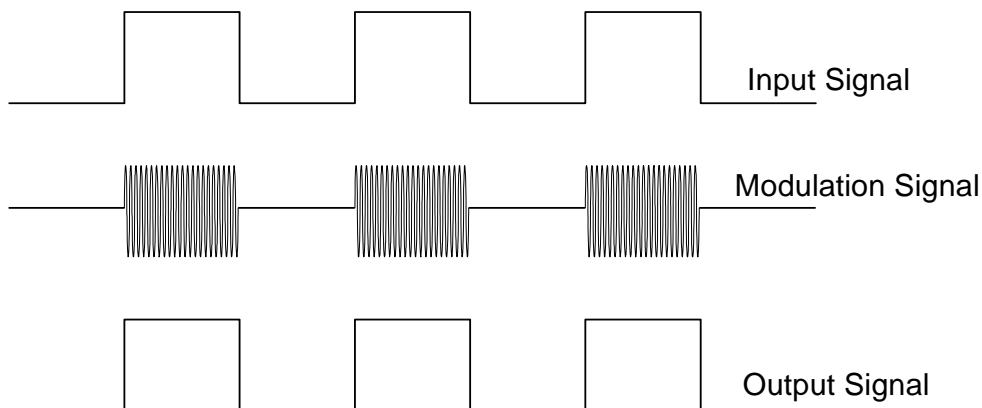
### 2.1. Theory of Operation

The operation of an Si846x channel is analogous to that of an opto coupler, except an RF carrier is modulated instead of light. This simple architecture provides a robust isolated data path and requires no special considerations or initialization at start-up. A simplified block diagram for a single Si846x channel is shown in Figure 3.



**Figure 3. Simplified Channel Diagram**

A channel consists of an RF Transmitter and RF Receiver separated by a semiconductor-based isolation barrier. Referring to the Transmitter, input A modulates the carrier provided by an RF oscillator using on/off keying. The Receiver contains a demodulator that decodes the input state according to its RF energy content and applies the result to output B via the output driver. This RF on/off keying scheme is superior to pulse code schemes as it provides best-in-class noise immunity, low power consumption, and better immunity to magnetic fields. See Figure 4 for more details.



**Figure 4. Modulation Scheme**

## 2.2. Eye Diagram

Figure 5 illustrates an eye-diagram taken on an Si8460. For the data source, the test used an Anritsu (MP1763C) Pulse Pattern Generator set to 1000 ns/div. The output of the generator's clock and data from an Si8460 were captured on an oscilloscope. The results illustrate that data integrity was maintained even at the high data rate of 150 Mbps. The results also show that 2 ns pulse width distortion and 250 ps peak jitter were exhibited.

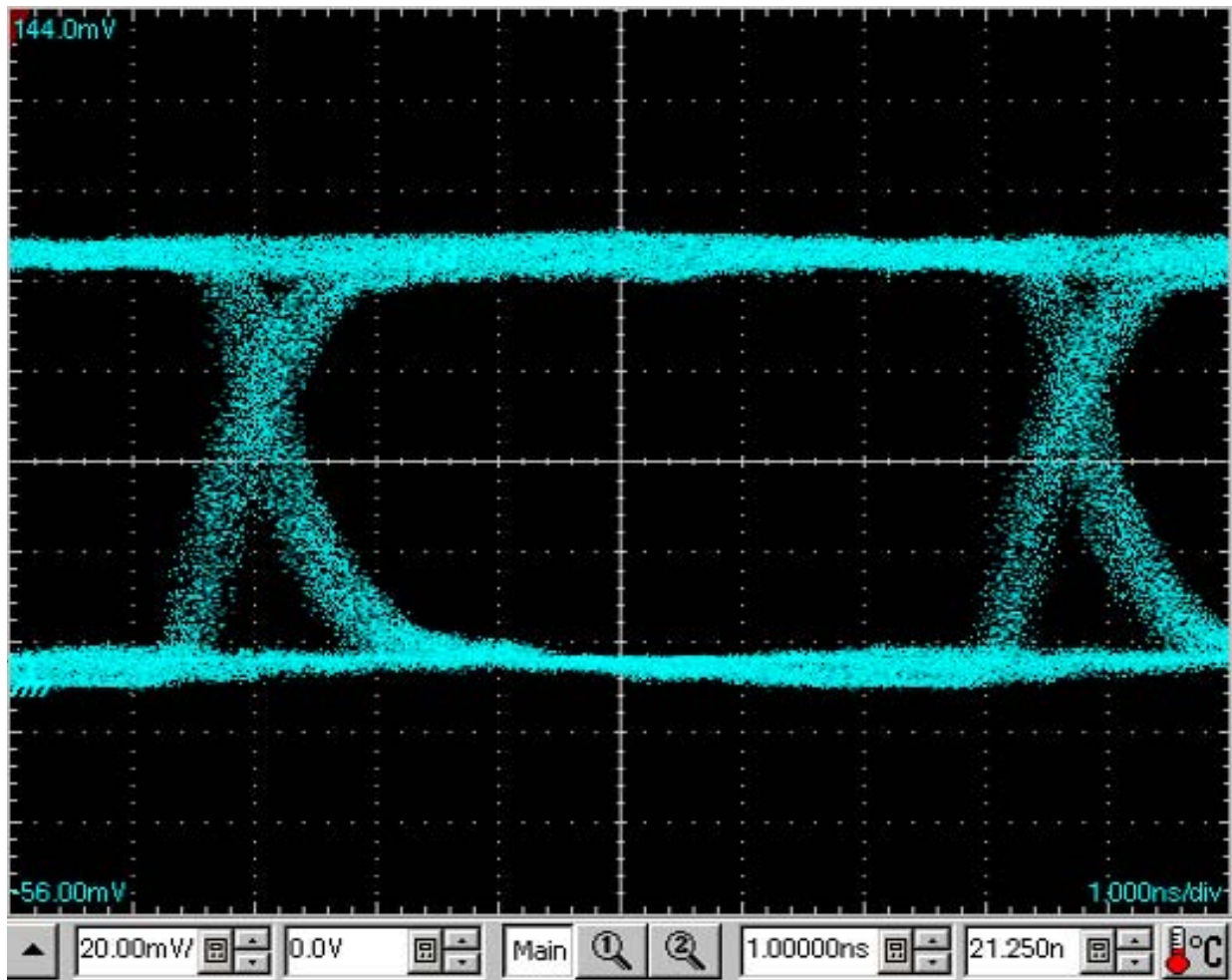


Figure 5. Eye Diagram

## 2.3. Device Operation

Device behavior during startup, normal operation, and shutdown is shown in Table 12.

**Table 12. Si846x Logic Operation Table**

| V <sub>I</sub> Input <sup>1,2</sup> | VDDI State <sup>1,3,4</sup> | VDDO State <sup>1,3,4</sup> | V <sub>O</sub> Output <sup>1,2</sup> | Comments   |
|-------------------------------------|-----------------------------|-----------------------------|--------------------------------------|--|
| H                                   | P                           | P                           | H                                    | Normal operation.  |
| L                                   | P                           | P                           | L                                    |  |
| X <sup>5</sup>                      | UP                          | P                           | L                                    | Upon transition of VDDI from unpowered to powered, V <sub>O</sub> returns to the same state as V <sub>I</sub> in less than 1 μs. |
| X <sup>5</sup>                      | P                           | UP                          | Undetermined                         | Upon transition of VDDO from unpowered to powered, V <sub>O</sub> returns to the same state as V <sub>I</sub> within 1 μs.       |

**Notes:**

1. VDDI and VDDO are the input and output power supplies. V<sub>I</sub> and V<sub>O</sub> are the respective input and output terminals.
2. X = not applicable; H = Logic High; L = Logic Low; Hi-Z = High Impedance.
3. "Powered" state (P) is defined as 2.70 V < VDD < 5.5 V.
4. "Unpowered" state (UP) is defined as VDD = 0 V.
5. Note that an I/O can power the die for a given side through an internal diode if its source has adequate current.

## 2.4. Layout Recommendations

To ensure safety in the end user application, high voltage circuits (i.e., circuits with  $>30 V_{AC}$ ) must be physically separated from the safety extra-low voltage circuits (SELV is a circuit with  $<30 V_{AC}$ ) by a certain distance (creepage/clearance). If a component, such as a digital isolator, straddles this isolation barrier, it must meet those creepage/clearance requirements and also provide a sufficiently large high-voltage breakdown protection rating (commonly referred to as working voltage protection). Table 6 on page 16 and Table 7 on page 17 detail the working voltage and creepage/clearance capabilities of the Si84xx. These tables also detail the component standards (UL1577, IEC60747, CSA 5A), which are readily accepted by certification bodies to provide proof for end-system specifications requirements. Refer to the end-system specification (61010-1, 60950-1, etc.) requirements before starting any design that uses a digital isolator.

The following sections detail the recommended bypass and decoupling components necessary to ensure robust overall performance and reliability for systems using the Si84xx digital isolators.

### 2.4.1. Supply Bypass

Digital integrated circuit components typically require  $0.1 \mu F$  ( $100 \text{ nF}$ ) bypass capacitors when used in electrically quiet environments. However, digital isolators are commonly used in hazardous environments with excessively noisy power supplies. To counteract these harsh conditions, it is recommended that an additional  $1 \mu F$  bypass capacitor be added between VDD and GND on both sides of the package. The capacitors should be placed as close as possible to the package to minimize stray inductance. If the system is excessively noisy, it is recommended that the designer add  $50$  to  $100 \Omega$  resistors in series with the VDD supply voltage source and  $50$  to  $300 \Omega$  resistors in series with the digital inputs/outputs (see Figure 6). For more details, see "3. Errata and Design Migration Guidelines" on page 27.

All components upstream or downstream of the isolator should be properly decoupled as well. If these components are not properly decoupled, their supply noise can couple to the isolator inputs and outputs, potentially causing damage if spikes exceed the maximum ratings of the isolator ( $6 \text{ V}$ ). In this case, the  $50$  to  $300 \Omega$  resistors protect the isolator's inputs/outputs (note that permanent device damage may occur if the absolute maximum ratings are exceeded). Functional operation should be restricted to the conditions specified in Table 1, "Recommended Operating Conditions," on page 4.

### 2.4.2. Pin Connections

No connect pins are not internally connected. They can be left floating, tied to  $V_{DD}$ , or tied to GND.

### 2.4.3. Output Pin Termination

The nominal output impedance of an isolator driver channel is approximately  $85 \Omega$ ,  $\pm 40\%$ , which is a combination of the value of the on-chip series termination resistor and channel resistance of the output driver FET. When driving loads where transmission line effects will be a factor, output pins should be appropriately terminated with controlled impedance PCB traces. The series termination resistor values should be scaled appropriately while keeping in mind the recommendations described in "2.4.1. Supply Bypass" above.

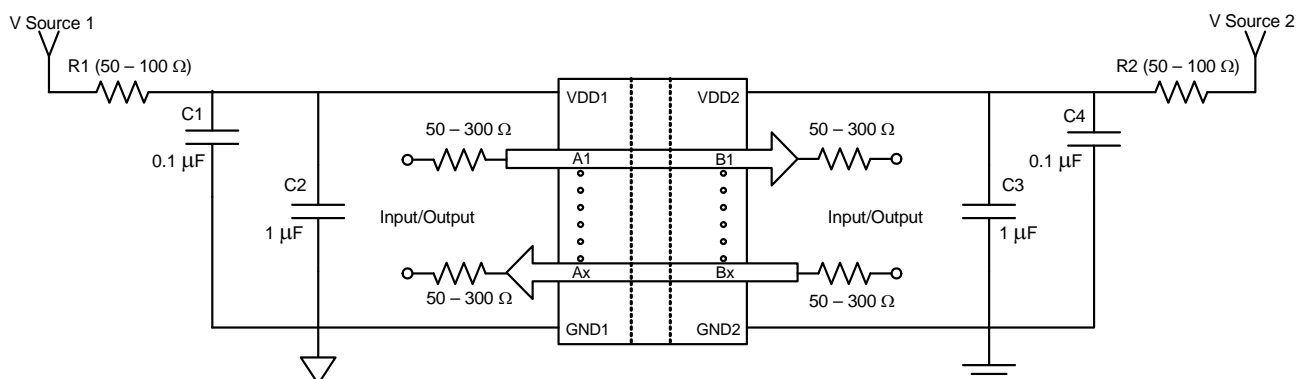
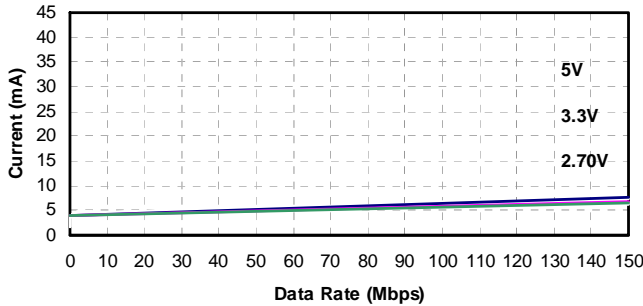


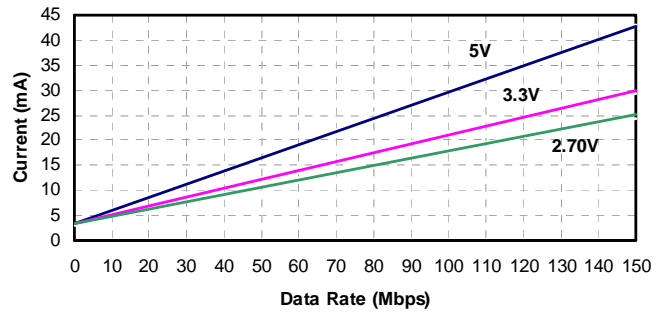
Figure 6. Recommended Bypass Components for the Si84xx Digital Isolator Family

## 2.5. Typical Performance Characteristics

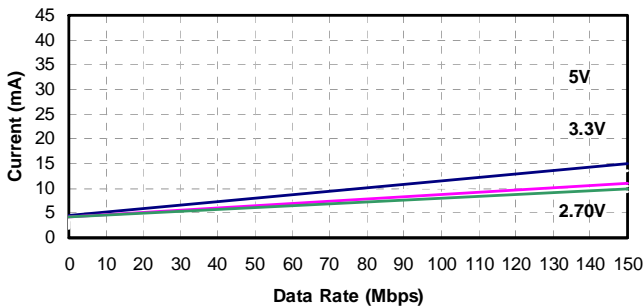
The typical performance characteristics depicted in the following diagrams are for information purposes only. Refer to Tables 3, 4, and 5 for actual specification limits.



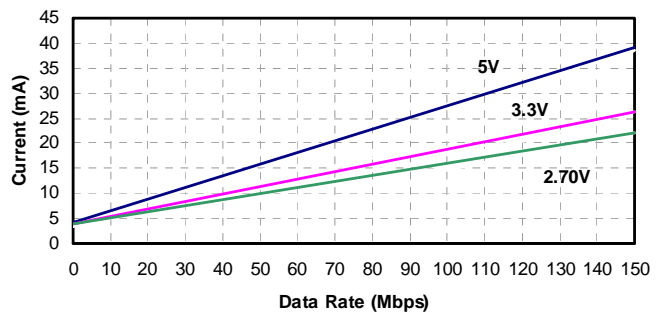
**Figure 7. Si8460 Typical  $V_{DD1}$  Supply Current vs. Data Rate 5, 3.3, and 2.70 V Operation**



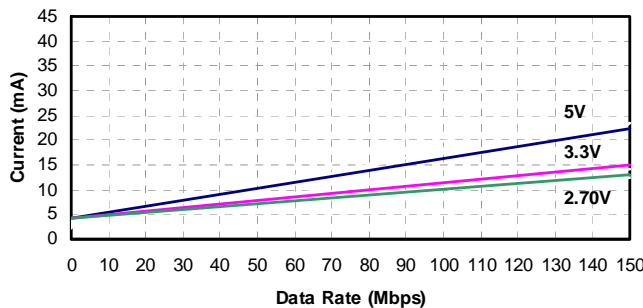
**Figure 10. Si8460 Typical  $V_{DD2}$  Supply Current vs. Data Rate 5, 3.3, and 2.70 V Operation (15 pF Load)**



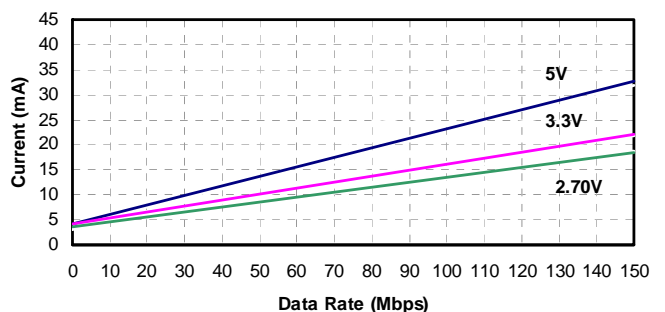
**Figure 8. Si8461 Typical  $V_{DD1}$  Supply Current vs. Data Rate 5, 3.3, and 2.70 V Operation (15 pF Load)**



**Figure 11. Si8461 Typical  $V_{DD2}$  Supply Current vs. Data Rate 5, 3.3, and 2.70 V Operation (15 pF Load)**

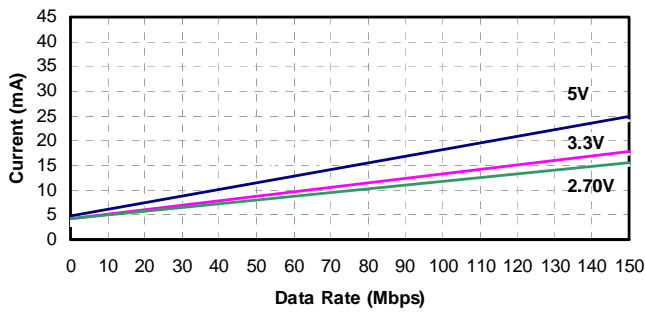


**Figure 9. Si8462 Typical  $V_{DD1}$  Supply Current vs. Data Rate 5, 3.3, and 2.70 V Operation (15 pF Load)**

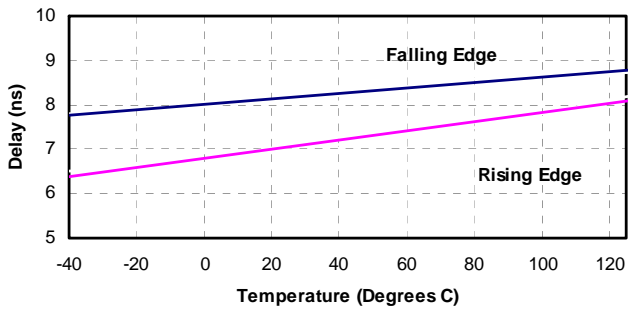


**Figure 12. Si8462 Typical  $V_{DD2}$  Supply Current vs. Data Rate 5, 3.3, and 2.70 V Operation (15 pF Load)**





**Figure 13. Si8463 Typical  $V_{DD1}$  or  $V_{DD2}$  Supply Current vs. Data Rate 5, 3.3, and 2.70 V Operation (15 pF Load)**



**Figure 14. Propagation Delay vs. Temperature**

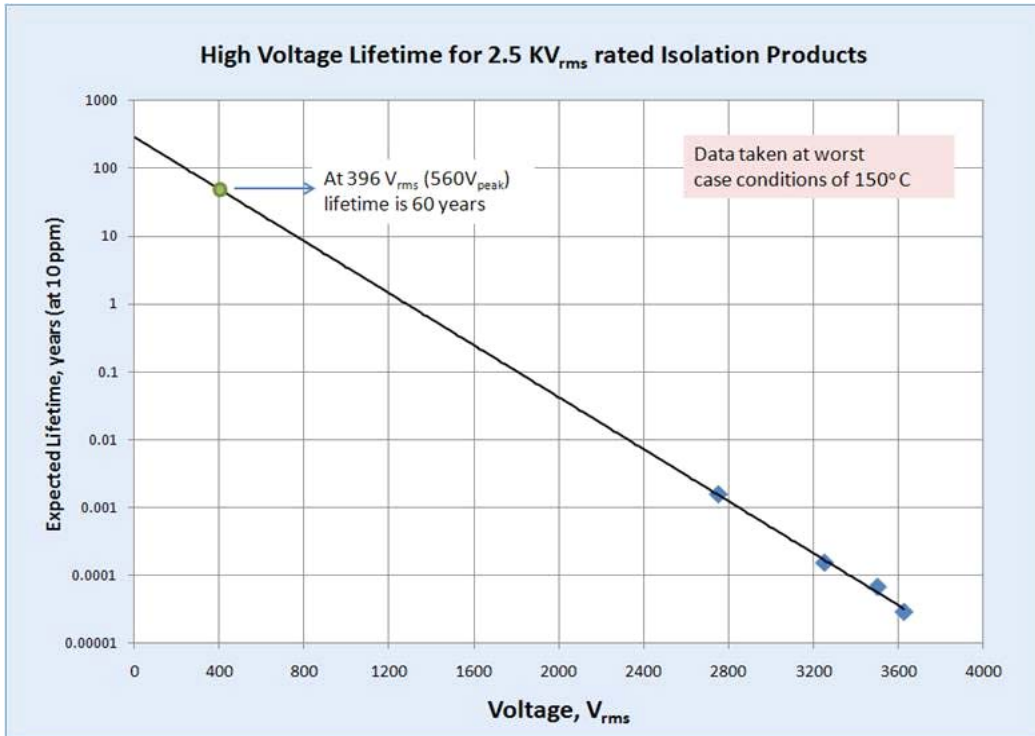


Figure 15. Si84xx Time-Dependent Dielectric Breakdown

### 3. Errata and Design Migration Guidelines

When using the new Si846x products, or when migrating from Silicon Labs' legacy isolators, designers must consider and adhere to the following requirements.

#### 3.1. Power Supply Bypass Capacitors (Revision A and Revision B)

When using the Si846x isolators with power supplies  $\geq 4.5$  V, sufficient VDD bypass capacitors must be present on both the VDD1 and VDD2 pins to ensure the VDD rise time is less than  $0.5 \text{ V}/\mu\text{s}$  (which is  $> 9 \mu\text{s}$  for a  $\geq 4.5$  V supply). Although rise time is power supply dependent,  $\geq 1 \mu\text{F}$  capacitors are required on both power supply pins (VDD1, VDD2) of the isolator device.

##### 3.1.1. Resolution

For recommendations on resolving this issue, see "2.4.1. Supply Bypass" on page 23. Additionally, refer to "5. Ordering Guide" on page 29 for current ordering information.

#### 3.2. Latch Up Immunity (Revision A Only)

Latch up immunity generally exceeds  $\pm 200$  mA per pin. Exceptions: Certain pins provide  $< 100$  mA of latch-up immunity. To increase latch-up immunity on these pins,  $100 \Omega$  of equivalent resistance must be included in series with *all* of the pins listed in Table 13. The  $100 \Omega$  equivalent resistance can be comprised of the source driver's output resistance and a series termination resistor.

##### 3.2.1. Resolution

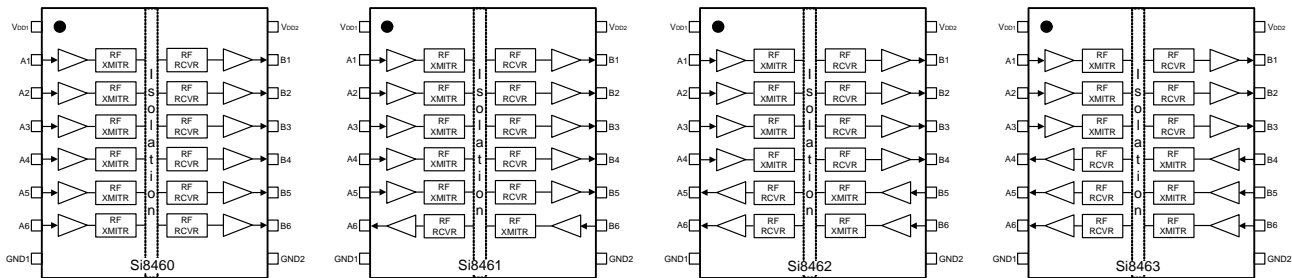
This issue has been corrected with Revision B of the device. Refer to "5. Ordering Guide" on page 29 for more information.

**Table 13. Affected Ordering Part Numbers (Revision A Only)**

| Affected Ordering Part Numbers*   | Device Revision | Pin# | Name | Pin Type        |
|---|-----------------|------|------|-----------------|
| SI8460SV-A-IS/IS1, SI8461SV-A-IS/IS1,<br>SI8462SV-A-IS/IS1, SI8463SV-A-IS/IS1 | A               | 2    | A1   | Input           |
|   |                 | 6    | A5   | Input or Output |
|   |                 | 10   | B6   | Input or Output |
|   |                 | 14   | B2   | Output          |
| *Note: SV = Speed Grade/Isolation Rating (AA, AB, BA, BB).                    |                 |      |      |                 |

# Si8460/61/62/63

## 4. Pin Descriptions



| Name             | SOIC-16 Pin# | Type           | Description                     |
|------------------|--------------|----------------|---------------------------------|
| V <sub>DD1</sub> | 1            | Supply         | Side 1 power supply.            |
| A1               | 2            | Digital Input  | Side 1 digital input.           |
| A2               | 3            | Digital Input  | Side 1 digital input.           |
| A3               | 4            | Digital Input  | Side 1 digital input.           |
| A4               | 5            | Digital I/O    | Side 1 digital input or output. |
| A5               | 6            | Digital I/O    | Side 1 digital input or output. |
| A6               | 7            | Digital I/O    | Side 1 digital input or output. |
| GND1             | 8            | Ground         | Side 1 ground.                  |
| GND2             | 9            | Ground         | Side 2 ground.                  |
| B6               | 10           | Digital I/O    | Side 2 digital input or output. |
| B5               | 11           | Digital I/O    | Side 2 digital input or output. |
| B4               | 12           | Digital I/O    | Side 2 digital input or output. |
| B3               | 13           | Digital Output | Side 2 digital output.          |
| B2               | 14           | Digital Output | Side 2 digital output.          |
| B1               | 15           | Digital Output | Side 2 digital output.          |
| V <sub>DD2</sub> | 16           | Supply         | Side 2 power supply.            |

## 5. Ordering Guide

Revision B devices are recommended for all new designs.

**Table 14. Ordering Guide for Valid OPNs<sup>1</sup>**

| Ordering Part Number (OPN)   | Number of Inputs VDD1 Side | Number of Inputs VDD2 Side | Maximum Data Rate (Mbps) | Isolation Rating | Temp Range    | Package Type |
|--|----------------------------|----------------------------|--------------------------|------------------|---------------|--------------|
| <b>Revision B Devices<sup>2</sup></b>  |                            |                            |                          |                  |               |              |
| Si8460AA-B-IS1   | 6                          | 0                          | 1                        | 1 kVrms          | -40 to 125 °C | NB SOIC-16   |
| Si8460BA-B-IS1   | 6                          | 0                          | 150                      |                  |               |              |
| Si8461AA-B-IS1   | 5                          | 1                          | 1                        |                  |               |              |
| Si8461BA-B-IS1   | 5                          | 1                          | 150                      |                  |               |              |
| Si8462AA-B-IS1   | 4                          | 2                          | 1                        |                  |               |              |
| Si8462BA-B-IS1   | 4                          | 2                          | 150                      |                  |               |              |
| Si8463AA-B-IS1   | 3                          | 3                          | 1                        |                  |               |              |
| Si8463BA-B-IS1   | 3                          | 3                          | 150                      |                  |               |              |
| Si8460AB-B-IS1   | 6                          | 0                          | 1                        | 2.5 kVrms        | -40 to 125 °C | NB SOIC-16   |
| Si8460BB-B-IS1   | 6                          | 0                          | 150                      |                  |               |              |
| Si8461AB-B-IS1   | 5                          | 1                          | 1                        |                  |               |              |
| Si8461BB-B-IS1   | 5                          | 1                          | 150                      |                  |               |              |
| Si8462AB-B-IS1   | 4                          | 2                          | 1                        |                  |               |              |
| Si8462BB-B-IS1   | 4                          | 2                          | 150                      |                  |               |              |
| Si8463AB-B-IS1   | 3                          | 3                          | 1                        |                  |               |              |
| Si8463BB-B-IS1   | 3                          | 3                          | 150                      |                  |               |              |
| <b>Notes:</b>  |                            |                            |                          |                  |               |              |
| 1. All packages are RoHS-compliant. Moisture sensitivity level is MSL2A with peak reflow temperature of 260 °C according to the JEDEC industry standard classifications and peak solder temperature. |                            |                            |                          |                  |               |              |
| 2. Revision A devices are supported for existing designs, but Revision B is recommended for all new designs.   |                            |                            |                          |                  |               |              |

**Table 14. Ordering Guide for Valid OPNs<sup>1</sup>**

| Ordering Part Number (OPN)   | Number of Inputs VDD1 Side | Number of Inputs VDD2 Side | Maximum Data Rate (Mbps) | Isolation Rating | Temp Range    | Package Type |
|--|----------------------------|----------------------------|--------------------------|------------------|---------------|--------------|
| <b>Revision A Devices<sup>2</sup></b>  |                            |                            |                          |                  |               |              |
| Si8460AA-A-IS1   | 6                          | 0                          | 1                        | 1 kVrms          | -40 to 125 °C | NB SOIC-16   |
| Si8460BA-A-IS1   | 6                          | 0                          | 150                      |                  |               |              |
| Si8461AA-A-IS1   | 5                          | 1                          | 1                        |                  |               |              |
| Si8461BA-A-IS1   | 5                          | 1                          | 150                      |                  |               |              |
| Si8462AA-A-IS1   | 4                          | 2                          | 1                        |                  |               |              |
| Si8462BA-A-IS1   | 4                          | 2                          | 150                      |                  |               |              |
| Si8463AA-A-IS1   | 3                          | 3                          | 1                        |                  |               |              |
| Si8463BA-A-IS1   | 3                          | 3                          | 150                      |                  |               |              |
| Si8460AB-A-IS1   | 6                          | 0                          | 1                        | 2.5 kVrms        | -40 to 125 °C | NB SOIC-16   |
| Si8460BB-A-IS1   | 6                          | 0                          | 150                      |                  |               |              |
| Si8461AB-A-IS1   | 5                          | 1                          | 1                        |                  |               |              |
| Si8461BB-A-IS1   | 5                          | 1                          | 150                      |                  |               |              |
| Si8462AB-A-IS1   | 4                          | 2                          | 1                        |                  |               |              |
| Si8462BB-A-IS1   | 4                          | 2                          | 150                      |                  |               |              |
| Si8463AB-A-IS1   | 3                          | 3                          | 1                        |                  |               |              |
| Si8463BB-A-IS1   | 3                          | 3                          | 150                      |                  |               |              |
| <b>Notes:</b>  |                            |                            |                          |                  |               |              |
| <ol style="list-style-type: none"> <li>1. All packages are RoHS-compliant. Moisture sensitivity level is MSL2A with peak reflow temperature of 260 °C according to the JEDEC industry standard classifications and peak solder temperature.</li> <li>2. Revision A devices are supported for existing designs, but Revision B is recommended for all new designs.</li> </ol> |                            |                            |                          |                  |               |              |

### 6. Package Outline: 16-Pin Narrow Body SOIC

Figure 16 illustrates the package details for the Si846x in a 16-pin narrow-body SOIC (SO-16). Table 15 lists the values for the dimensions shown in the illustration.

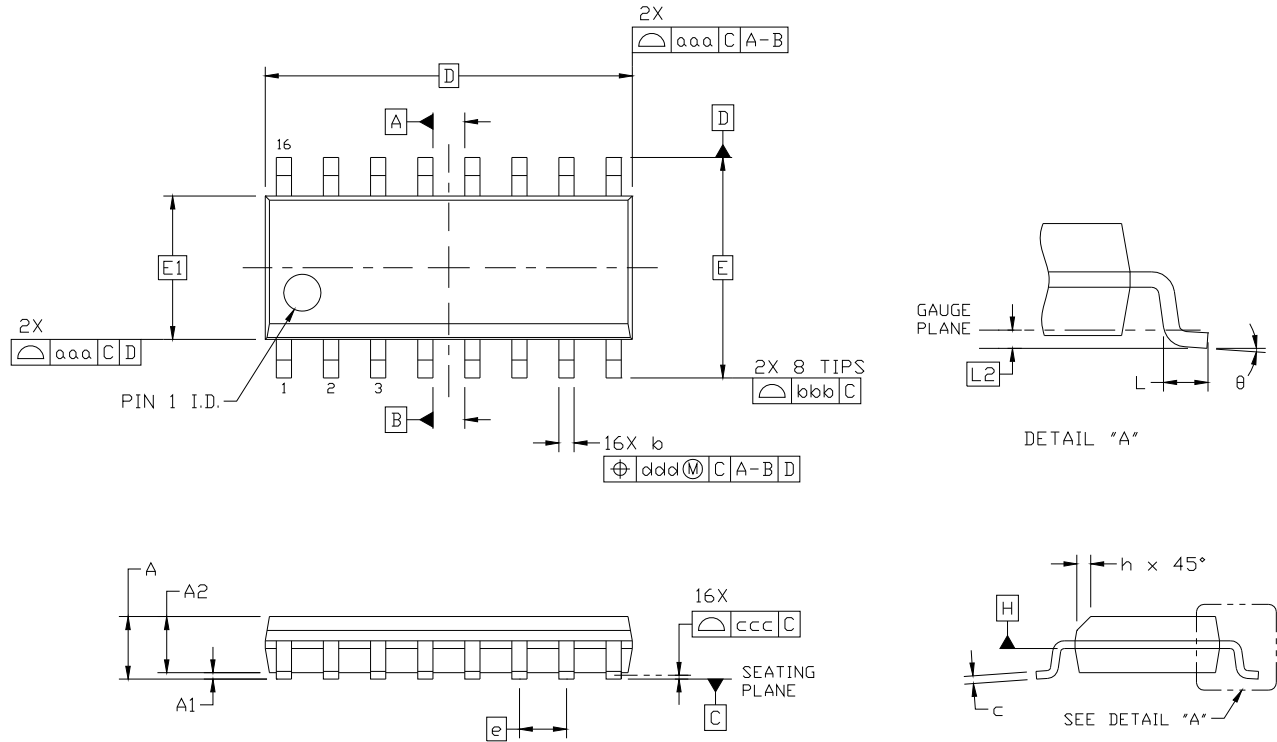


Figure 16. 16-pin Small Outline Integrated Circuit (SOIC) Package

Table 15. Package Diagram Dimensions

| Dimension | Min      | Max  |
|-----------|----------|------|
| A         | —        | 1.75 |
| A1        | 0.10     | 0.25 |
| A2        | 1.25     | —    |
| b         | 0.31     | 0.51 |
| c         | 0.17     | 0.25 |
| D         | 9.90 BSC |      |
| E         | 6.00 BSC |      |
| E1        | 3.90 BSC |      |
| e         | 1.27 BSC |      |
| L         | 0.40     | 1.27 |
| L2        | 0.25 BSC |      |

**Table 15. Package Diagram Dimensions (Continued)**

|          |      |      |
|----------|------|------|
| h        | 0.25 | 0.50 |
| $\theta$ | 0°   | 8°   |
| aaa      | 0.10 |      |
| bbb      | 0.20 |      |
| ccc      | 0.10 |      |
| ddd      | 0.25 |      |

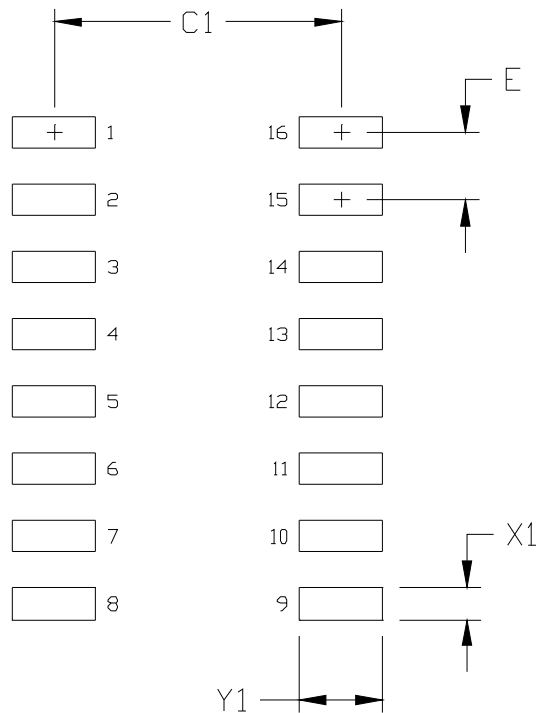
**Notes:**

1. All dimensions shown are in millimeters (mm) unless otherwise noted.
2. Dimensioning and Tolerancing per ANSI Y14.5M-1994.
3. This drawing conforms to the JEDEC Solid State Outline MS-012, Variation AC.
4. Recommended card reflow profile is per the JEDEC/IPC J-STD-020 specification for Small Body Components.



## 7. Land Pattern: 16-Pin Narrow Body SOIC

Figure 17 illustrates the recommended land pattern details for the Si846x in a 16-pin narrow-body SOIC. Table 16 lists the values for the dimensions shown in the illustration.



**Figure 17. 16-Pin Narrow Body SOIC PCB Land Pattern**

**Table 16. 16-Pin Narrow Body SOIC Land Pattern Dimensions**

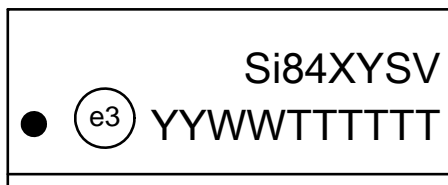
| Dimension | Feature            | (mm) |
|-----------|--------------------|------|
| C1        | Pad Column Spacing | 5.40 |
| E         | Pad Row Pitch      | 1.27 |
| X1        | Pad Width          | 0.60 |
| Y1        | Pad Length         | 1.55 |

**Notes:**

1. This Land Pattern Design is based on IPC-7351 pattern SOIC127P600X165-16N for Density Level B (Median Land Protrusion).
2. All feature sizes shown are at Maximum Material Condition (MMC) and a card fabrication tolerance of 0.05 mm is assumed.

## 8. Top Marking: 16-Pin Narrow Body SOIC

### 8.1. 16-Pin Narrow Body SOIC Top Marking



### 8.2. Top Marking Explanation

|                        |  |   |
|------------------------|--|---|
| <b>Line 1 Marking:</b> | Base Part Number<br>Ordering Options<br><br>(See Ordering Guide for more information). | Si84 = Isolator product series<br>XY = Channel Configuration<br>X = # of data channels (6, 5, 4, 3, 2, 1)<br>Y = # of reverse channels (3, 2, 1, 0)<br>S = Speed Grade<br>A = 1 Mbps; B = 150 Mbps<br>V = Insulation rating<br>A = 1 kV; B = 2.5 kV |
|                        | <b>Line 2 Marking:</b>   | Circle = 1.2 mm Diameter  |
|                        | YY = Year<br>WW = Work Week  | "e3" Pb-Free Symbol   |
|                        | TTTTTT = Mfg code  | Assigned by the Assembly House. Corresponds to the year and work week of the mold date.   |
|                        | Circle = 1.2 mm diameter   | Manufacturing Code from Assembly Purchase Order form.   |
|                        |  | "e3" Pb-Free Symbol.  |

## DOCUMENT CHANGE LIST

### Revision 0.1 to Revision 0.2

- Updated all specs to reflect latest silicon.
- Added "3. Errata and Design Migration Guidelines" on page 27.
- Added "8. Top Marking: 16-Pin Narrow Body SOIC" on page 34.

### Revision 0.2 to Revision 1.0

- Updated document to reflect availability of Revision B silicon.
- Updated Tables 3,4, and 5.
  - Updated all supply currents and channel-channel skew.
- Updated Table 2.
  - Updated absolute maximum supply voltage.
- Updated Table 7.
  - Updated clearance and creepage dimensions.
- Updated "3. Errata and Design Migration Guidelines" on page 27.
- Updated "5. Ordering Guide" on page 29.

### Revision 1.0 to Revision 1.1

- Updated Tables 3, 4, and 5.
  - Updated notes in tables to reflect output impedance of 85  $\Omega$ .
  - Updated rise and fall time specifications.
  - Updated CMTI value.

### Revision 1.1 to Revision 1.2

- Updated document throughout to include MSL improvements to MSL2A.
- Updated "5. Ordering Guide" on page 29.
  - Updated Note 1 in ordering guide table to reflect improvement and compliance to MSL2A moisture sensitivity level.

### Revision 1.2 to Revision 1.3

- Updated " Features" on page 1.
- Moved Tables 1 and 2 to page 4.
- Updated Tables 6, 7, 8, and 9.
- Updated Table 12 footnotes.
- Added Figure 15, "Si84xx Time-Dependent Dielectric Breakdown," on page 26.

### Revision 1.3 to Revision 1.4

- Updated "4. Pin Descriptions" on page 28.
  - Removed note for narrow-body devices.
- Updated "2.4.1. Supply Bypass" on page 23.
- Added Figure 6, "Recommended Bypass Components for the Si84xx Digital Isolator Family," on page 23.
- Updated "3.1. Power Supply Bypass Capacitors (Revision A and Revision B)" on page 27.

## CONTACT INFORMATION

### Silicon Laboratories Inc.

400 West Cesar Chavez  
Austin, TX 78701  
Tel: 1+(512) 416-8500  
Fax: 1+(512) 416-9669  
Toll Free: 1+(877) 444-3032

Please visit the Silicon Labs Technical Support web page:  
<https://www.silabs.com/support/pages/contacttechnicalsupport.aspx>  
and register to submit a technical support request.

The information in this document is believed to be accurate in all respects at the time of publication but is subject to change without notice. Silicon Laboratories assumes no responsibility for errors and omissions, and disclaims responsibility for any consequences resulting from the use of information included herein. Additionally, Silicon Laboratories assumes no responsibility for the functioning of undescribed features or parameters. Silicon Laboratories reserves the right to make changes without further notice. Silicon Laboratories makes no warranty, representation or guarantee regarding the suitability of its products for any particular purpose, nor does Silicon Laboratories assume any liability arising out of the application or use of any product or circuit, and specifically disclaims any and all liability, including without limitation consequential or incidental damages. Silicon Laboratories products are not designed, intended, or authorized for use in applications intended to support or sustain life, or for any other application in which the failure of the Silicon Laboratories product could create a situation where personal injury or death may occur. Should Buyer purchase or use Silicon Laboratories products for any such unintended or unauthorized application, Buyer shall indemnify and hold Silicon Laboratories harmless against all claims and damages.

Silicon Laboratories and Silicon Labs are trademarks of Silicon Laboratories Inc.  
Other products or brandnames mentioned herein are trademarks or registered trademarks of their respective holders.