

"Slot Seven" 7 mm Tunable Inductors

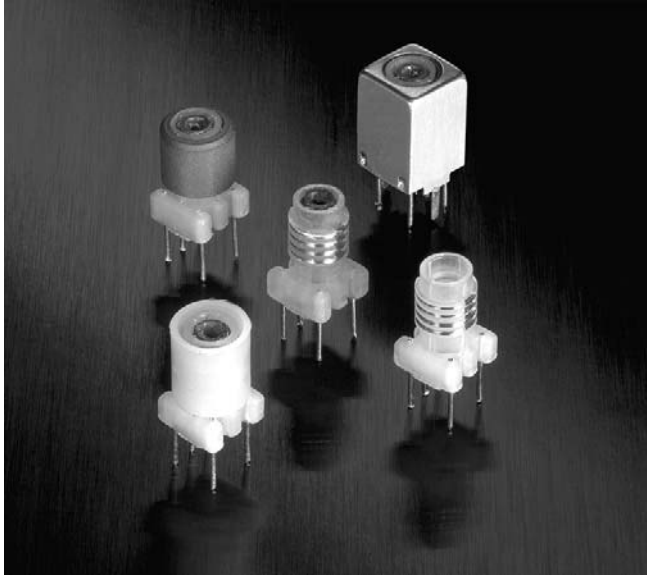

This product is not RoHS-compliant. Contact Coilcraft for current status or possible alternatives.

These versatile Coilcraft variable inductors operate over a wide range of frequencies. Standard inductance values are available from less than 100 nH to over 250 μ H. Custom values can also be provided upon request.

Coilcraft "Slot Seven" RF coils come in an international 7 mm package. Their precision-molded slotted bobbins ensure tight tolerances and high stability.

A variety of shielding options are offered. "Slot Seven" coils are tuned by means of slotted ferrite tuning cores for easy, positive adjustment. Use the Coilcraft Slot Tuner for a precise fit to the tuning slug.

Coilcraft **Designer's Kit M106** contains 39 coils (3 each). To order, please contact Coilcraft or purchase on-line at <http://order.coilcraft.com>.

Recommended Board Layout

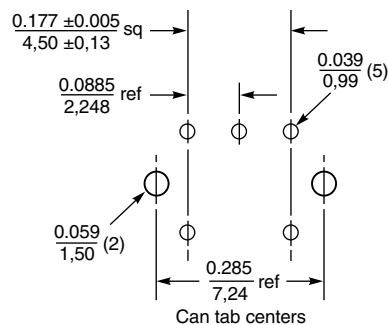

Bottom View

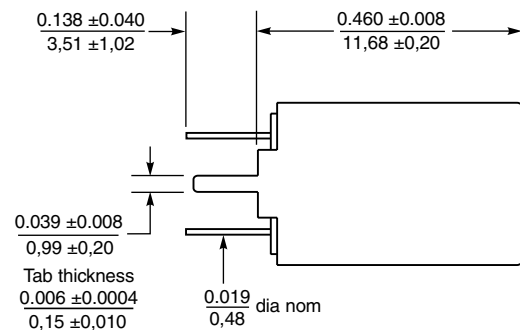
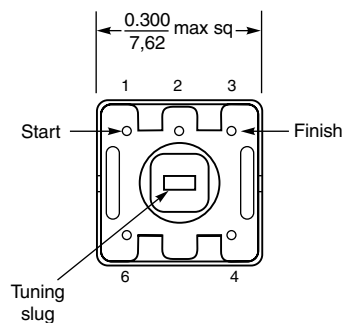

Weight	7M2 series	1.00 – 1.06 g
	7M3 series	1.30 – 1.34 g

Schematic

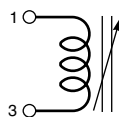

"SLOT TUNER" TUNING TOOL



Specially designed for this product series. SEE INDEX

Coilcraft[®]

Specifications subject to change without notice.
Please check our website for latest information.

Document 112-1 Revised 02/16/05

1102 Silver Lake Road Cary, Illinois 60013 Phone 847/639-6400 Fax 847/639-1469

E-mail info@coilcraft.com Web <http://www.coilcraft.com>

“Slot Seven” 7 mm Tunable Inductors

Series 7M2 — Shielded with Plastic Sleeve

Part Number	L min (μH)	L nom (μH)	L max (μH)	Test frequency	Q min @ L nom	DCR max (Ohms)
7M2-101	0.094	0.100	0.106	25 MHz	27	0.124
7M2-121	0.113	0.120	0.127	25 MHz	27	0.124
7M2-151	0.141	0.150	0.159	25 MHz	30	0.151
7M2-181	0.169	0.180	0.191	25 MHz	30	0.151
7M2-221	0.207	0.220	0.233	25 MHz	35	0.176
7M2-271	0.254	0.270	0.286	25 MHz	35	0.198
7M2-331	0.310	0.330	0.350	25 MHz	40	0.248
7M2-391	0.367	0.390	0.413	25 MHz	40	0.271
7M2-471	0.442	0.470	0.498	25 MHz	40	0.291
7M2-561	0.526	0.560	0.594	25 MHz	40	0.317
7M2-681	0.612	0.680	0.748	25 MHz	40	0.333
7M2-821	0.738	0.820	0.902	25 MHz	45	0.368
7M2-102	0.9	1.0	1.1	25 MHz	45	0.396
7M2-122	1.1	1.2	1.3	7.9 MHz	27	0.412
7M2-152	1.4	1.5	1.7	7.9 MHz	27	0.466
7M2-182	1.6	1.8	2.0	7.9 MHz	27	0.544
7M2-222	2.0	2.2	2.4	7.6 MHz	27	0.595
7M2-272	2.4	2.7	3.0	7.9 MHz	27	0.898
7M2-332	3.0	3.3	3.6	7.9 MHz	27	1.04
7M2-392	3.5	3.9	4.3	7.9 MHz	27	1.12
7M2-472	4.2	4.7	5.2	7.9 MHz	27	1.38
7M2-562	5.0	5.6	6.2	7.9 MHz	27	1.42
7M2-682	6.1	6.8	7.5	7.9 MHz	27	1.49
7M2-822	7.4	8.2	9.0	7.9 MHz	27	1.65
7M2-103	9.0	10	11	7.9 MHz	27	2.42
7M2-123	10	12	14	2.5 MHz	20	2.75
7M2-153	13	15	17	2.5 MHz	20	3.71
7M2-183	15	18	21	2.5 MHz	20	4.01
7M2-223	19	22	25	2.5 MHz	20	7.37
7M2-273	23	27	31	2.5 MHz	20	8.48
7M2-333	28	33	38	2.5 MHz	20	13.34
7M2-393	33	39	45	2.5 MHz	20	14.72
7M2-473	40	47	54	2.5 MHz	20	16.42
7M2-563	48	56	64	2.5 MHz	20	17.76
7M2-683	58	68	78	2.5 MHz	20	19.76
7M2-823	70	82	94	2.5 MHz	20	22.01
7M2-104	85	100	115	2.5 MHz	20	24.25

Parts in bold are included in Coilcraft Designer's Kit M106.

Typical Q at L nom — Series 7M2

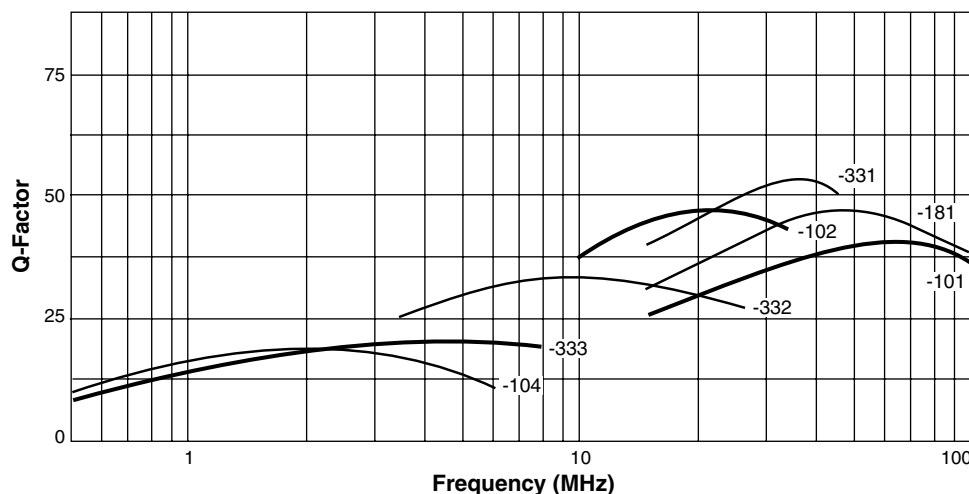

Notes:

- All readings taken on Agilent/HP 4342-A Q Meter.
- L min is achieved at maximum extension of the core toward PC board. Complete tuning range is reached within the boundaries of the coil form.
- All specifications are at standard “Q” meter frequencies. L and Q readings change with frequency.
- Shielded parts have a sleeve insert to protect the winding.
- Operating temperature range -40°C to +85°C.
- Electrical specifications at 25°C.

COILCRAFT ACCURATE
PRECISION REPEATABLE
MEASUREMENTS
SEE INDEX **TEST FIXTURES**

Coilcraft[®]

Specifications subject to change without notice.
Please check our website for latest information.

Document 112-2 Revised 11/21/02

1102 Silver Lake Road Cary, Illinois 60013 Phone 847/639-6400 Fax 847/639-1469

E-mail info@coilcraft.com Web <http://www.coilcraft.com>

“Slot Seven” 7 mm Tunable Inductors

Series 7M3 — Shielded with Ferrite Sleeve

Part number	L min (μH)	L nom (μH)	L max (μH)	Test frequency	Q min @ L nom	DCR max (Ohms)
7M3-151	0.128	0.150	0.173	25 MHz	40	0.124
7M3-181	0.153	0.180	0.207	25 MHz	45	0.124
7M3-221	0.187	0.220	0.253	25 MHz	45	0.151
7M3-271	0.230	0.270	0.311	25 MHz	50	0.151
7M3-331	0.281	0.330	0.380	25 MHz	50	0.151
7M3-391	0.332	0.390	0.449	25 MHz	55	0.176
7M3-471	0.400	0.470	0.541	25 MHz	55	0.198
7M3-561	0.476	0.560	0.644	25 MHz	60	0.198
7M3-681	0.544	0.680	0.816	25 MHz	60	0.248
7M3-821	0.656	0.820	0.984	25 MHz	60	0.271
7M3-102	0.8	1.0	1.2	25 MHz	60	0.317
7M3-122	1.0	1.2	1.4	7.9 MHz	45	0.333
7M3-152	1.2	1.5	1.8	7.9 MHz	45	0.368
7M3-182	1.4	1.8	2.2	7.9 MHz	45	0.396
7M3-222	1.8	2.2	2.6	7.9 MHz	45	0.412
7M3-272	2.2	2.7	3.2	7.9 MHz	45	0.466
7M3-332	2.6	3.3	4.0	7.9 MHz	40	0.544
7M3-392	3.1	3.9	4.7	7.9 MHz	40	0.595
7M3-472	3.8	4.7	5.6	7.9 MHz	40	0.898
7M3-562	4.5	5.6	6.7	7.9 MHz	40	1.04
7M3-682	5.4	6.8	8.2	7.9 MHz	35	1.04
7M3-822	6.6	8.2	9.8	7.9 MHz	35	1.12
7M3-103	8	10	12	7.9 MHz	35	1.38
7M3-123	9	12	15	2.5 MHz	35	1.49
7M3-153	11	15	19	2.5 MHz	35	1.65
7M3-183	14	18	23	2.5 MHz	35	2.42
7M3-223	17	22	28	2.5 MHz	35	2.75
7M3-273	20	27	34	2.5 MHz	40	3.71
7M3-333	25	33	41	2.5 MHz	40	3.71
7M3-393	29	39	49	2.5 MHz	40	4.01
7M3-473	35	47	59	2.5 MHz	40	7.37
7M3-563	42	56	70	2.5 MHz	40	8.48
7M3-683	51	68	85	2.5 MHz	40	13.34
7M3-823	62	82	103	2.5 MHz	40	14.72
7M3-104	75	100	125	2.5 MHz	40	16.42
7M3-124	90	120	150	2.5 MHz	40	17.76
7M3-154	113	150	188	2.5 MHz	40	19.76
7M3-184	135	180	225	2.5 MHz	40	22.01
7M3-224	165	220	275	2.5 MHz	40	24.25

Parts in bold are included in Coilcraft Designer's Kit M106.

Typical Q at L nom — Series 7M3

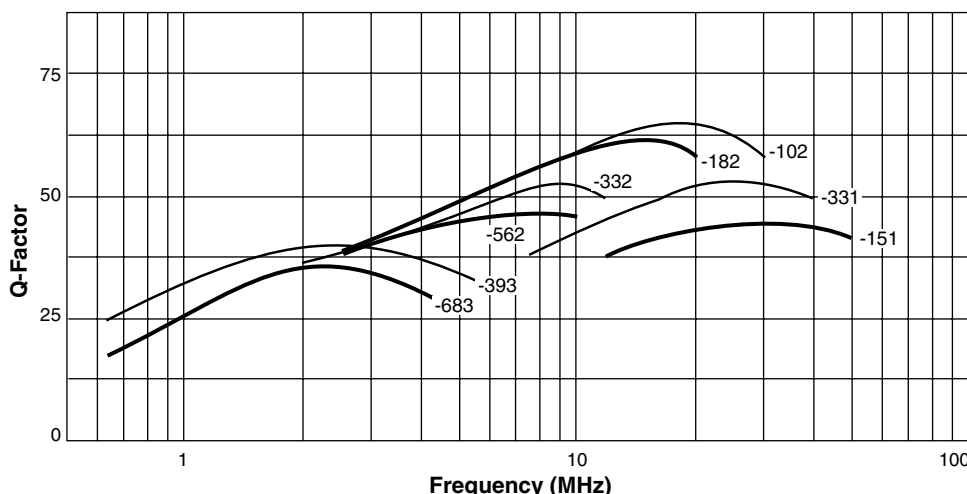

Notes:

- All readings taken on Agilent/HP 4342-A Q Meter.
- L min is achieved at maximum extension of the core toward PC board. Complete tuning range is reached within the boundaries of the coil form.
- All specifications are at standard “Q” meter frequencies. L and Q readings change with frequency.
- Shielded parts have a sleeve insert to protect the winding.
- Operating temperature range -40°C to +85°C.
- Electrical specifications at 25°C.

COILCRAFT ACCURATE
PRECISION REPEATABLE
MEASUREMENTS
SEE INDEX **TEST FIXTURES**

Coilcraft[®]

Specifications subject to change without notice.
Please check our website for latest information.

Document 112-3 Revised 11/21/02

1102 Silver Lake Road Cary, Illinois 60013 Phone 847/639-6400 Fax 847/639-1469

E-mail info@coilcraft.com Web <http://www.coilcraft.com>

“Slot Seven” 7 mm Tunable Inductors

Typical Self Resonant Frequency

At nominal inductance

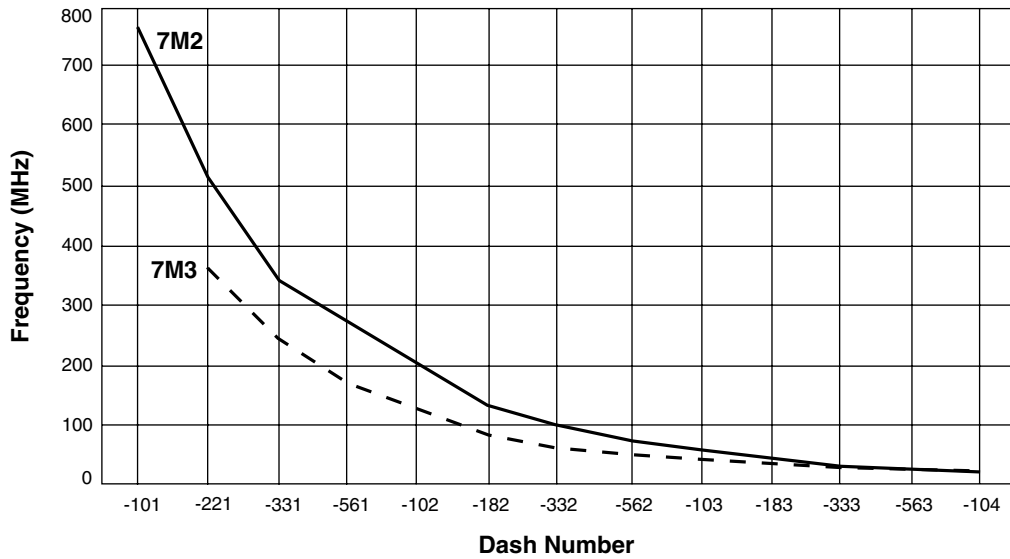

Coilcraft[®]

Specifications subject to change without notice.
Please check our website for latest information.

Document 112-4 Revised 11/21/02

1102 Silver Lake Road Cary, Illinois 60013 Phone 847/639-6400 Fax 847/639-1469

E-mail info@coilcraft.com Web <http://www.coilcraft.com>

© Coilcraft, Inc. 2007