



Panasonic[®]



Large Can

Aluminum Electrolytic Capacitors

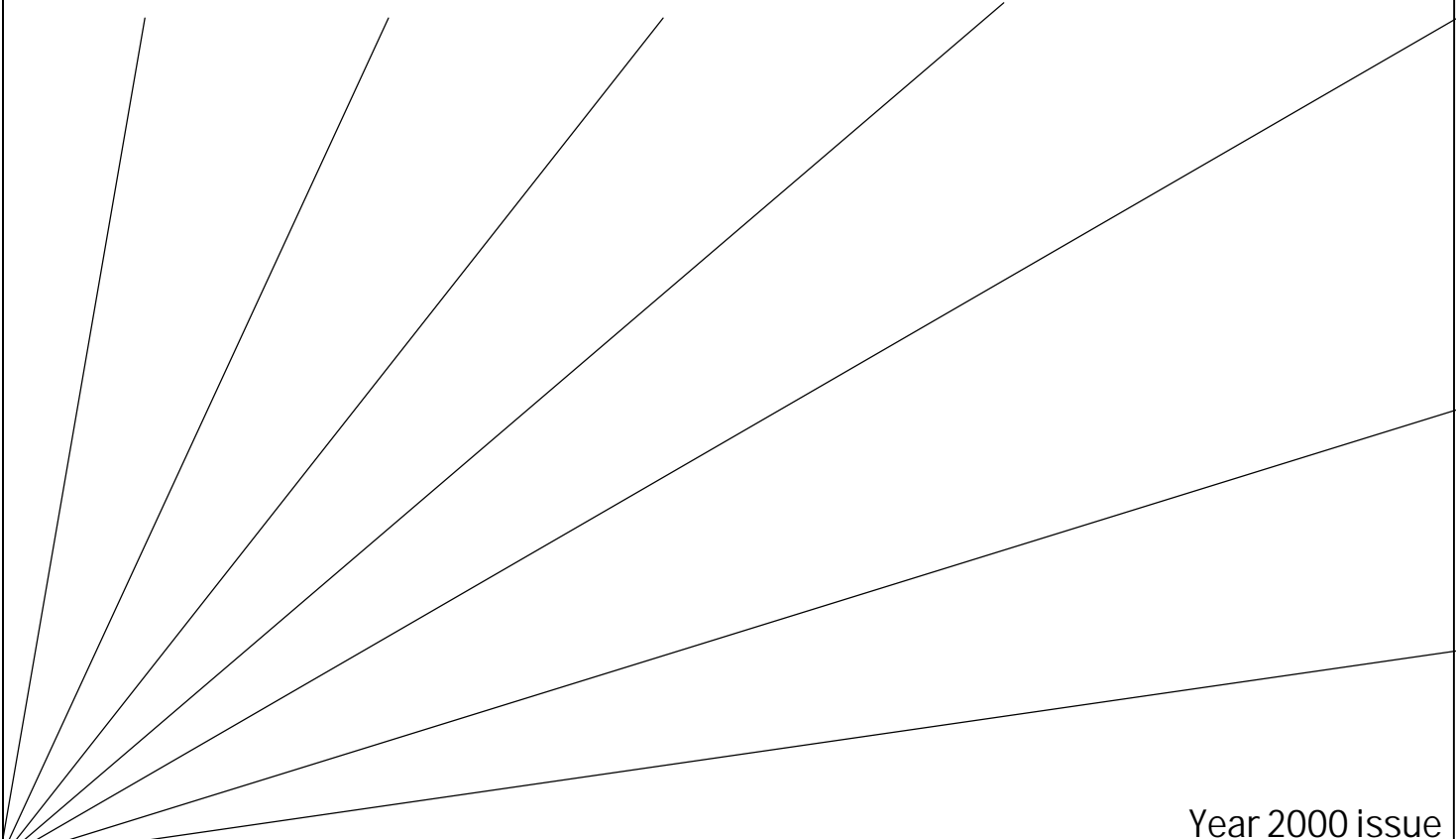

Year 2000 issue



Matsushita Electronic Components Corporation of America (ACOM) has been manufacturing aluminum electrolytic capacitors since 1982.

ACOM initially produced the popular 2 pin, snap-in capacitor. Manufacturing has expanded with the introduction of multi-pin snap-in and computer grade capacitors.

New and expanded range products in this catalog include:

- **Expanded capacitance ratings (TS-UP series)**
- **Expanded case sizes**
 - **40mm diameters (TS-UP, TS-HA, TS-HB series)**
 - **50mm diameters, lengths to 105mm (T-UP, T-HA series)**
- **Screw terminal products (G-AA, G-BA series)**
- **500WV products (TS-UP, T-UP, G-AA series)**

This catalog contains general information and standard product listings for aluminum electrolytic capacitors produced by Matsushita Electronic Components Corporation of America (ACOM).

Special designs and more comprehensive technical information are available upon request. Contact your Panasonic sales representative for details.

The information contained herein is believed to be accurate at the time of publication. Design and specifications are subject to change without notice.

No ozone depleting substances (ODS) under the Montreal Protocol are used in the manufacturing process for these products.

The ACOM capacitor plant is ISO 9001 registered.

Capacitor Quick Guide

Series	Features	Endurance (Load Life)	Voltage Range (WV)	Cap. Range (μ F)	Size Range D x L (mm)	Comments	Page
2 terminal snap-in style (TS Type)							7
TS-UP	High CV	85°C 2000 ~ 3000h	16 ~ 500	33 ~ 68,000	20 x 25 ~ 40 x 50	Extended CV ratings, 40mm diameters, 500WV available	8
TS-HA	High CV High Ripple Long Life	105°C 2000 ~ 3000h	10 ~ 450	33 ~ 68,000	20 x 25 ~ 40 x 50	20mm low profile lengths available	13
TS-HB	Very High CV High Ripple Long Life	105°C 3000h	160 ~ 450	82 ~ 2,700	22 x 30 ~ 40 x 50	40mm diameters available	17
TS-XB	Premium Industrial Grade	105°C 7000h	160 ~ 450	39 ~ 2,200	22 x 25 ~ 35 x 50	Longest life TS type	19
TS-EX	VDE-0806 Specification	105°C 2000h	250	100 ~ 1,200	22 x 25 ~ 35 x 50	VDE-0806 over- voltage capability	22
4 / 5 terminal snap-in style (T Type)							23
T-UP	High CV High Ripple	85°C 3000h	16 ~ 500	470 ~ 120,000	35 x 40 ~ 50 x 105	50mm diameters, 500WV ratings available	24
T-HA	Long Life High Ripple	105°C 3000h	16 ~ 450	390 ~ 120,000	35 x 40 ~ 50 x 105	50mm diameter sizes available	27
Screw terminal "computer grade" style (G Type)							29
G-AA	High CV Industrial Grade	85°C 3000h	16 ~ 500	150 ~ 1,200,000	35 x 40 ~ 77 x 220	English and metric terminals available	30
G-BA	Long Life Industrial Grade	105°C 2000h	10 ~ 450	220 ~ 1,200,000	35 x 40 ~ 77 x 220	English and metric terminals available	34

1 General Specifications

Capacitance

Nominal capacitance is specified at 120Hz frequency and 20°C temperature. Unless specified otherwise, standard capacitance tolerance is ±20% of the nominal value.

Working Voltage

The maximum allowable sum of continuous DC voltage plus peak ripple voltage which can be applied to the capacitor.

Surge Voltage

The maximum transient voltage level allowed for short periods of time without sustaining permanent damage to the capacitor. Values are listed in the standard product ratings.

Leakage Current

$I = 3\sqrt{CV}$ (μA) maximum after 5 minutes of applying rated voltage. Capacitance is the nominal value in μF, voltage in VDC.

Ripple Current

The standard product tables list ripple current allowable limits at specified maximum operating temperatures.

Correction factors for other temperatures and frequencies are listed in the general sections for the general product type.

Endurance (Life) Test

Duration: Specified hours of life
 Ambient Temp.: Maximum specified operating temperature
 Applied Voltage: DC voltage with maximum specified ripple current applied (the sum of the applied DC voltage plus the peak ripple voltage should not exceed rated working voltage)

Post test requirements at +20°C:

Leakage Current: ≤ Initial specified value
 Cap. change: ≤ ±20% of initial measured value
 D. F. / E.S.R.: ≤ 200% of initial specified value

Shelf Life

Duration: 1000 hours
 Ambient Temp.: Maximum specified operating temperature
 Applied Voltage: None

Post test requirements at +20°C:

Same as Endurance Test requirements above.

Measurements are to be performed after applying DC working voltage for 30 minutes.

2 Life Expectancy

Panasonic capacitors have a specified life at a maximum temperature and ripple current. Typical life can be considerably longer based on actual life test results performed by the factory. This data can be provided to help the designer estimate expected life. This information is given with a 60% confidence level.

Capacitor life at lower temperatures follows "The Doubling 10°C Rule" where life is doubled for each 10°C reduction in operating temperature. The following equation is useful for determining the life of a capacitor in the application;

$$L_2 = L_1 \times 2^{\frac{T_1 - (T_2 + \Delta T)}{10}}$$

where:

L_1 = Specified life (hours) at maximum operating temperature. Typical life may be substituted (at a 60% confidence level).
 L_2 = Expected life (hours) at actual operating temperature.
 T_1 = Maximum operating temperature.
 T_2 = Ambient temperature (°C).
 ΔT = Ripple current temperature rise (°C).

It is recommended that the ripple current heat rise be limited to 15°C at lower ambient temperatures as higher temperature rises may reduce operating life.

End of life is defined by the occurrence of one of the following when stabilized at 20°C;

- ◆ Capacitance change exceeds ±20% of the initial measured value.
- ◆ Dissipation Factor exceeds 200% of the initial specified value.

2 Life Expectancy (continued)

- ◆ Leakage Current exceeds the initial specified value.

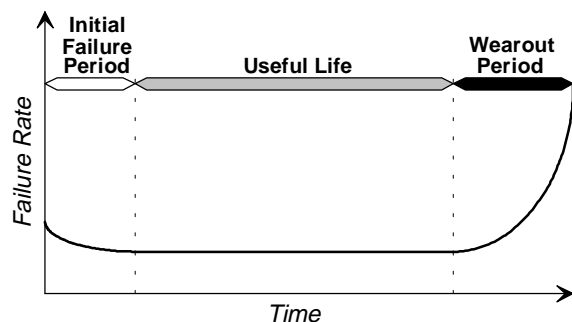

Life Cycle of an Aluminum Electrolytic Capacitor

3 Circuit Design Considerations

Operating Temperature and Frequency

Aluminum electrolytic capacitor electrical characteristics are normally specified at a temperature of 20°C and a frequency of 120Hz. Electrical parameters are temperature and frequency dependent as follows;

(1) Effects of operating temperature

At higher temperatures, capacitance and leakage current increase while ESR decreases.

At lower temperatures, capacitance and leakage current will decrease while ESR increases.

(2) Effects of frequency

Capacitance, impedance, and ESR will decrease as frequency increases.

At lower frequencies, ripple current generated temperature will rise due to increasing ESR.

Reverse Voltage

DC capacitors have polarity which must be verified before insertion.

Avoid use in circuits with changing or uncertain polarity.

Ensure that allowable ripple currents superimposed on low DC bias voltages do not cause reverse voltage conditions.

Charge / Discharge Applications

Standard capacitors are not suitable for use in repeating charge / discharge applications.

Capacitors Connected in Parallel

Circuit resistance can approximate the series resistance of the capacitor, resulting in ripple current load imbalances. Careful design of wiring methods can minimize excessive ripple currents applied to a capacitor.

Capacitors Connected in Series

Normal DC leakage current variations among capacitors can cause voltage differences. The use of voltage dividing sharing resistors with consideration to leakage currents can compensate for voltage imbalances.

Electrical Precautions

Transient recovery voltage may be generated in the capacitor due to dielectric absorption. Typical voltage levels are less than 10% of the rated capacitor voltage. If required, this voltage can be discharged with a resistor.

The aluminum case of the capacitor has an indeterminate resistance to the cathode terminal. The vinyl sleeve on the capacitor is for marking and identification purposes and is not meant to electrically isolate the capacitor.

When designing circuits, consider worst case capacitor failure modes such as open or short circuits.

The effects of hot, electrically conductive, combustible, electrolyte liquid or vapor escaping from the safety vent should also be considered.

4 Capacitor Mounting Considerations

Circuit Board Design

Avoid wiring pattern runs which pass between the mounted capacitor and the circuit board. When dipping into a solder bath, excessive solder may collect under the capacitor by capillary action and short circuit the anode and cathode terminals.

4 Mounting Considerations (continued)

The vinyl sleeve of the capacitor can be damaged if solder passes through a lead hole for subsequently processed parts.

Electrically isolate the extra terminal(s) on T type products from the anode terminal, cathode terminal, and other circuit paths.

Clearance Requirements

Case mounted pressure relief vents require sufficient clearance to operate properly. The minimum clearance is diameter dependent as follows: 20~ 35mm diameters, 3mm minimum. 40mm diameters or greater, 5mm minimum.

Circuit Board Cleaning

Aluminum electrolytic capacitors can withstand immersion or ultrasonic cleaning with "safe" cleaning solvents for up to 5 minutes and 60°C maximum temperatures.

Most aqueous based cleaning solvents and detergents are acceptable. Some solvent groups could damage capacitors as follows:

- ◆ Halogenated cleaning solvents may permeate the capacitor seal, causing internal corrosion and failure.
- ◆ Alkali solvents may attack and dissolve the aluminum case.
- ◆ Petroleum based solvents may deteriorate the rubber seal.
- ◆ Xylene may deteriorate the rubber seal.
- ◆ Acetone may remove vinyl sleeve ink printing.

A thorough rinsing and drying process will prevent entrapment of residual solvents between the capacitor and the circuit board. Excessive drying temperatures and / or radiant heat drying sources may result in splitting or excessive shrinkage of the vinyl sleeve.

Mounting Adhesives and Coating Agents

When using mounting adhesives or coating agents, avoid materials with halogenated cleaning solvents including chloroprene based polymers.

A thorough drying process after application is required to prevent solvent entrapment between the capacitor and the circuit board.

Mounting adhesives or reinforcement clamps are recommended on 2 terminal, TS types with case sizes of ϕ 35 x 45mm or larger. Additional mounting support is also recommended for 4 or 5 terminal, T types with lengths exceeding 63mm.

5 Storage

Leakage current will increase with long storage times.

Storage times in ambient temperatures of 40°C or less can be four years or more before leakage current should be checked for conformance to the specified limit.

Longer storage times may require reforming of the capacitor to reduce leakage current below the specified limit. This can be accomplished by applying rated voltage in series with a 1000 Ω resistor for a time period of 30 ~ 60 minutes.

Under normal conditions, shelf life can exceed 10 years, providing that leakage current is checked before use.

Long term storage in high humidity conditions could cause oxidation of the terminal plating which could adversely affect solderability.

6 Safety Precautions

If the pressure relief vent of the capacitor should operate, immediately turn off the equipment and disconnect from the power source. This will minimize additional damage caused by the vaporizing electrolyte.

Avoid contact with the escaping electrolyte which can exceed 100°C temperatures.

If electrolyte or vapors enter the eye, immediately flush the eye with large amounts of water and seek medical attention.

If electrolytes or vapors are ingested by mouth, gargle with water.

If electrolyte contacts the skin, wash with soap and water.

TS Type General Information

Dimensions

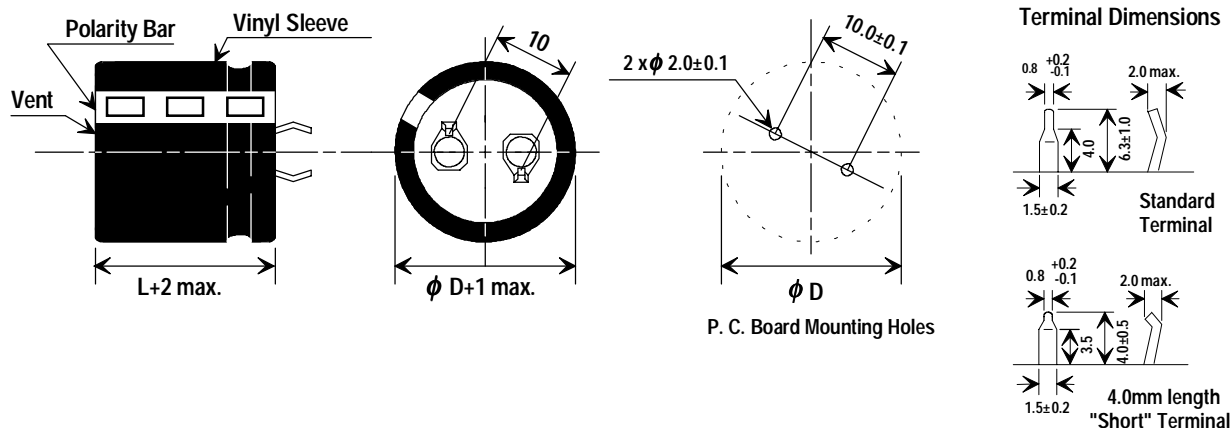

Ripple Current Multipliers

Frequency (Hz):	50	60	100~120	500	1k	10k~50k
16~100WV:	0.93	0.95	1.0	1.05	1.08	1.15
160~500WV:	0.75	0.8	1.0	1.2	1.25	1.4

Max. Temperature	105°C	85°C	70°C	60°C	≤45°C
TS-UP	---	1.0	1.3	1.4	1.5
TS-HA, HB, XB, EX	1.0	1.7	2.0	2.2	2.35

Note: Use of temperature correction factors can limit load life to the hours specified for the maximum operating temperature of the series.

TS-UP Series two terminal snap-in

- Compact size for general purpose and industrial applications
- **NEW:** 500 WV ratings, 40mm diameter sizes, extended capacitance ratings
- Wide range of case sizes including 20mm lengths for low profile applications
- Can vent construction



Rated Working Voltage:	16 ~ 250 VDC	350 ~ 500 VDC
Operating Temperature:	-40 ~ +85°C	-25 ~ +85°C
Nominal Capacitance:	120 ~ 68000µF (±20% tolerance)	33 ~ 680µF (±20% tolerance)
Dissipation Factor: (120 Hz, +20°C)	Working Voltage [V]:	16 25 35 50 63 80 100 160 ~ 500
	Max. D.F. (%):	50 40 35 30 25 20 20 15
Endurance:	3000 hours* at +85°C with maximum specified ripple current (see page 4) *2000 hours for 20mm diameter or 20mm length sizes	

For capacitance values > 33000µF, add the value of: $\frac{\text{(rated cap. } \mu\text{F)} - 33000}{1000}$

Part Number System

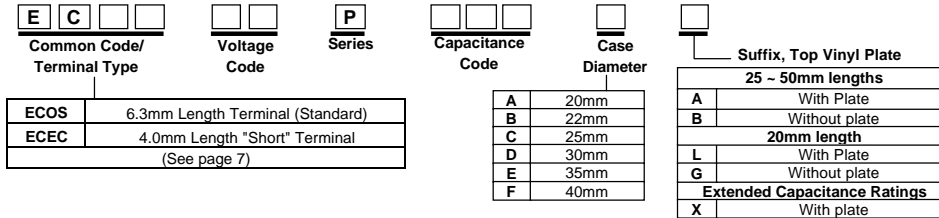

TS-UP Standard Ratings

Cap. (µF)	Size (mm) D x L	Max 85°C R.C. (A _{rms})		Max. 20°C ESR (Ω)		Panasonic Part Number	Cap. (µF)	Size (mm) D x L	Max 85°C R.C. (A _{rms})		Max. 20°C ESR (Ω)		Panasonic Part Number
		120Hz	10k-50kHz	120Hz	20kHz				120Hz	10k-50kHz	120Hz	20kHz	
16 VDC Working, 20 VDC Surge							25 VDC Working, 32 VDC Surge						
6800	20 x 25	3.15	3.62	0.098	0.083	ECOS1CP682AA	4700	20 x 25	3.05	3.51	0.113	0.090	ECOS1EP472AA
8200	20 x 30	3.47	3.99	0.081	0.069	ECOS1CP822AA	5600	20 x 30	3.36	3.86	0.095	0.076	ECOS1EP562AA
10000	20 x 35	3.78	4.35	0.066	0.056	ECOS1CP103AA	6800	20 x 35	3.47	3.99	0.078	0.062	ECOS1EP682AA
12000	20 x 35	4.52	5.20	0.062	0.053	ECOS1CP123AA	8200	20 x 40	3.57	4.11	0.065	0.052	ECOS1EP822AA
15000	20 x 40	5.26	6.05	0.053	0.045	ECOS1CP153AA	3300	22 x 20	1.60	1.84	0.176	0.141	ECOS1EP332BL
4700	22 x 20	1.60	1.84	0.159	0.135	ECOS1CP472BL	6800	22 x 30	3.47	3.99	0.078	0.062	ECOS1EP682BA
10000	22 x 30	3.78	4.35	0.075	0.063	ECOS1CP103BA	8200	22 x 30	3.57	4.11	0.065	0.052	ECOS1EP822BA
12000	22 x 30	4.52	5.20	0.062	0.053	ECOS1CP123BA	10000	22 x 35	3.78	4.35	0.058	0.046	ECOS1EP103BA
15000	22 x 35	5.26	6.05	0.053	0.045	ECOS1CP153BA	12000	22 x 40	4.10	4.72	0.048	0.039	ECOS1EP123BA
18000	22 x 40	5.57	6.41	0.046	0.039	ECOS1CP183BA	15000	22 x 50	4.63	5.32	0.039	0.031	ECOS1EP153BA
22000	22 x 45	6.10	7.02	0.038	0.032	ECOS1CP223BA	4700	25 x 20	1.80	2.07	0.123	0.099	ECOS1EP472CL
6800	25 x 20	1.80	2.07	0.110	0.093	ECOS1CP682CL	6800	25 x 25	3.47	3.99	0.078	0.062	ECOS1EP682CA
10000	25 x 25	3.78	4.35	0.075	0.063	ECOS1CP103CA	8200	25 x 25	3.57	4.11	0.065	0.052	ECOS1EP822CA
12000	25 x 25	4.52	5.20	0.062	0.053	ECOS1CP123CA	10000	25 x 30	3.78	4.35	0.058	0.046	ECOS1EP103CA
15000	25 x 30	5.26	6.05	0.053	0.045	ECOS1CP153CA	12000	25 x 35	4.10	4.72	0.048	0.039	ECOS1EP123CA
18000	25 x 30	5.57	6.41	0.046	0.039	ECOS1CP183CA	15000	25 x 40	4.63	5.32	0.039	0.031	ECOS1EP153CA
22000	25 x 35	6.10	7.02	0.038	0.032	ECOS1CP223CA	18000	25 x 45	5.47	6.29	0.035	0.028	ECOS1EP183CA
27000	25 x 45	6.31	7.26	0.031	0.026	ECOS1CP273CA	22000	25 x 50	6.10	7.02	0.029	0.023	ECOS1EP223CA
33000	25 x 50	6.84	7.87	0.025	0.021	ECOS1CP333CA	6800	30 x 20	2.30	2.65	0.078	0.062	ECOS1EP682DL
10000	30 x 20	2.40	2.76	0.083	0.070	ECOS1CP103DL	10000	30 x 25	3.78	4.35	0.058	0.046	ECOS1EP103DA
22000	30 x 30	6.10	7.02	0.038	0.032	ECOS1CP223DA	12000	30 x 30	4.10	4.72	0.048	0.039	ECOS1EP123DA
27000	30 x 35	6.31	7.26	0.031	0.026	ECOS1CP273DA	15000	30 x 30	4.63	5.32	0.039	0.031	ECOS1EP153DA
33000	30 x 40	6.84	7.87	0.025	0.021	ECOS1CP333DA	18000	30 x 35	5.47	6.29	0.035	0.028	ECOS1EP183DA
39000	30 x 45	6.94	7.98	0.021	0.018	ECOS1CP393DA	22000	30 x 40	6.10	7.02	0.029	0.023	ECOS1EP223DA
47000	30 x 50	7.47	8.59	0.019	0.017	ECOS1CP473DA	27000	30 x 45	6.21	7.14	0.023	0.019	ECOS1EP273DA
15000	35 x 20	3.20	3.68	0.055	0.047	ECOS1CP153EL	33000	30 x 50	6.84	7.87	0.020	0.017	ECOS1EP333DA
33000	35 x 30	6.84	7.87	0.025	0.021	ECOS1CP333EA	10000	35 x 20	2.70	3.11	0.061	0.049	ECOS1EP103EL
39000	35 x 35	6.94	7.98	0.021	0.018	ECOS1CP393EA	27000	35 x 35	6.21	7.14	0.025	0.020	ECOS1EP273EA
47000	35 x 40	7.47	8.59	0.021	0.019	ECOS1CP473EA	33000	35 x 40	6.84	7.87	0.020	0.017	ECOS1EP333EA
56000	35 x 45	8.73	10.04	0.019	0.018	ECOS1CP563EA	39000	35 x 45	7.36	8.46	0.019	0.017	ECOS1EP393EA
68000	35 x 50	9.05	10.41	0.018	0.017	ECOS1CP683EA	47000	35 x 50	8.00	9.20	0.017	0.015	ECOS1EP473EA
68000	40 x 40	9.05	10.41	0.018	0.017	ECOS1CP683FA	47000	40 x 40	8.00	9.20	0.017	0.015	ECOS1EP473FA
82000	40 x 50	10.29	11.83	0.016	0.015	ECOS1CP823FA	56000	40 x 50	8.96	10.30	0.016	0.015	ECOS1EP563FA

TS-UP Standard Ratings (continued)

Cap. (μ F)	Size (mm) D x L	Max. 85°C R.C. (A_{rms})		Max. 20°C ESR (Ω)		Panasonic Part Number	Cap. (μ F)	Size (mm) D x L	Max. 85°C R.C. (A_{rms})		Max. 20°C ESR (Ω)		Panasonic Part Number
		120Hz	10k-50kHz	120Hz	20kHz				120Hz	10k-50kHz	120Hz	20kHz	
400 VDC Working, 450 VDC Surge							450 VDC Working, 500 VDC Surge						
82	20 x 30	0.83	1.16	2.022	0.708	ECOS2GP820AA	56	20 x 30	0.70	0.98	2.960	1.184	ECOS2WP560AA
100	20 x 35	0.92	1.29	1.658	0.580	ECOS2GP101AA	82	20 x 35	0.83	1.16	2.022	0.809	ECOS2WP820AA
120	20 x 40	1.02	1.43	1.382	0.484	ECOS2GP121AA	33	22 x 20	0.20	0.28	6.028	2.411	ECOS2WP330BL
47	22 x 20	0.25	0.35	3.527	1.235	ECOS2GP470BL	56	22 x 25	0.70	0.98	2.960	1.184	ECOS2WP560BA
82	22 x 25	0.83	1.16	2.022	0.708	ECOS2GP820BA	82	22 x 30	0.83	1.16	2.022	0.809	ECOS2WP820BA
100	22 x 30	0.92	1.29	1.658	0.580	ECOS2GP101BA	100	22 x 35	0.93	1.30	1.658	0.663	ECOS2WP101BA
120	22 x 35	1.02	1.43	1.382	0.484	ECOS2GP121BA	120	22 x 40	1.04	1.46	1.382	0.553	ECOS2WP121BA
150	22 x 40	1.16	1.62	1.105	0.387	ECOS2GP151BA	150	22 x 50	1.19	1.67	1.105	0.442	ECOS2WP151BA
180	22 x 45	1.44	2.02	0.921	0.322	ECOS2GP181BA	47	25 x 20	0.29	0.41	4.233	1.693	ECOS2WP470CL
220	22 x 50	1.49	2.09	0.754	0.264	ECOS2GP221BA	82	25 x 25	0.83	1.16	2.022	0.809	ECOS2WP820CA
68	25 x 20	0.35	0.49	2.926	1.024	ECOS2GP680CL	120	25 x 30	1.04	1.46	1.382	0.553	ECOS2WP121CA
100	25 x 25	0.92	1.29	1.658	0.580	ECOS2GP101CA	150	25 x 40	1.19	1.67	1.105	0.442	ECOS2WP151CA
120	25 x 25	1.02	1.43	1.382	0.484	ECOS2GP121CX	180	25 x 40	1.35	1.89	0.921	0.368	ECOS2WP181CX
150	25 x 30	1.16	1.62	1.105	0.387	ECOS2GP151CA	180	25 x 45	1.35	1.89	0.921	0.368	ECOS2WP181CA
180	25 x 30	1.44	2.02	0.921	0.322	ECOS2GP181CX	220	25 x 45	1.55	2.17	0.754	0.301	ECOS2WP221CX
180	25 x 35	1.44	2.02	0.921	0.322	ECOS2GP181CA	220	25 x 50	1.55	2.17	0.754	0.301	ECOS2WP221CA
220	25 x 40	1.49	2.09	0.754	0.264	ECOS2GP221CA	68	30 x 20	0.38	0.53	2.926	1.170	ECOS2WP680DL
270	25 x 45	1.67	2.34	0.675	0.236	ECOS2GP271CA	120	30 x 25	1.04	1.46	1.382	0.553	ECOS2WP121DA
100	30 x 20	0.47	0.66	1.989	0.696	ECOS2GP101DL	150	30 x 30	1.19	1.67	1.105	0.442	ECOS2WP151DA
150	30 x 25	1.16	1.62	1.105	0.387	ECOS2GP151DA	180	30 x 30	1.35	1.89	0.921	0.368	ECOS2WP181DX
220	30 x 30	1.49	2.09	0.754	0.264	ECOS2GP221DA	180	30 x 35	1.35	1.89	0.921	0.368	ECOS2WP181DA
270	30 x 35	1.67	2.34	0.675	0.236	ECOS2GP271DA	220	30 x 35	1.55	2.17	0.754	0.301	ECOS2WP221DX
330	30 x 40	1.90	2.66	0.553	0.193	ECOS2GP331DA	220	30 x 40	1.55	2.17	0.754	0.301	ECOS2WP221DA
390	30 x 45	2.13	2.98	0.468	0.164	ECOS2GP391DA	270	30 x 45	1.78	2.49	0.675	0.270	ECOS2WP271DA
150	35 x 20	0.60	0.84	1.326	0.464	ECOS2GP151EL	330	30 x 50	2.01	2.81	0.553	0.249	ECOS2WP331DA
270	35 x 30	1.67	2.34	0.675	0.236	ECOS2GP271EA	100	35 x 20	0.52	0.73	1.989	0.796	ECOS2WP101EL
330	35 x 30	1.90	2.66	0.553	0.193	ECOS2GP331EX	180	35 x 25	1.35	1.89	0.921	0.368	ECOS2WP181EA
330	35 x 35	1.90	2.66	0.553	0.193	ECOS2GP331EA	220	35 x 30	1.55	2.17	0.754	0.301	ECOS2WP221EA
390	35 x 35	2.13	2.98	0.468	0.164	ECOS2GP391EX	270	35 x 30	1.78	2.49	0.675	0.270	ECOS2WP271EX
390	35 x 40	2.13	2.98	0.468	0.164	ECOS2GP391EA	270	35 x 35	1.78	2.49	0.675	0.270	ECOS2WP271EA
470	35 x 40	2.39	3.35	0.388	0.136	ECOS2GP471EX	330	35 x 35	2.01	2.81	0.553	0.249	ECOS2WP331EX
470	35 x 45	2.39	3.35	0.388	0.136	ECOS2GP471EA	330	35 x 40	2.01	2.81	0.553	0.249	ECOS2WP331EA
560	35 x 45	2.69	3.77	0.326	0.114	ECOS2GP561EX	390	35 x 45	2.24	3.14	0.510	0.255	ECOS2WP391EA
560	35 x 50	2.69	3.77	0.326	0.114	ECOS2GP561EA	470	35 x 45	2.53	3.54	0.423	0.233	ECOS2WP471EX
680	35 x 50	3.00	4.20	0.268	0.094	ECOS2GP681EX	470	35 x 50	2.53	3.54	0.423	0.233	ECOS2WP471EA
560	40 x 40	2.69	3.77	0.326	0.114	ECOS2GP561FA	470	40 x 40	2.53	3.54	0.423	0.233	ECOS2WP471FA
820	40 x 50	3.38	4.73	0.222	0.078	ECOS2GP821FA	680	40 x 50	3.15	4.41	0.293	0.161	ECOS2WP681FA
500 VDC Working, 550 VDC Surge													
47	22 x 25	0.63	0.88	3.527	1.411	ECOS2HP470BA							
56	22 x 30	0.70	0.98	2.960	1.184	ECOS2HP560BA							
68	22 x 35	0.78	1.09	2.438	0.975	ECOS2HP680BA							
82	22 x 40	0.88	1.23	2.022	0.809	ECOS2HP820BA							
100	22 x 45	0.99	1.39	1.658	0.663	ECOS2HP101BA							
120	22 x 50	1.13	1.58	1.382	0.553	ECOS2HP121BA							
68	25 x 25	0.78	1.09	2.438	0.975	ECOS2HP680CA							
82	25 x 30	0.88	1.23	2.022	0.809	ECOS2HP820CA							
100	25 x 35	0.99	1.39	1.658	0.663	ECOS2HP101CA							
120	25 x 40	1.13	1.58	1.382	0.553	ECOS2HP121CA							
150	25 x 45	1.29	1.80	1.105	0.442	ECOS2HP151CA							
180	25 x 50	1.38	1.93	0.921	0.368	ECOS2HP181CA							
120	30 x 30	1.13	1.58	1.382	0.553	ECOS2HP121DA							
150	30 x 35	1.29	1.80	1.105	0.442	ECOS2HP151DA							
180	30 x 40	1.38	1.93	0.921	0.368	ECOS2HP181DA							
220	30 x 45	1.50	2.10	0.754	0.339	ECOS2HP221DA							
150	35 x 25	1.20	1.68	1.105	0.442	ECOS2HP151EA							
180	35 x 30	1.36	1.90	0.921	0.368	ECOS2HP181EA							
220	35 x 35	1.54	2.16	0.754	0.301	ECOS2HP221EA							
270	35 x 40	1.76	2.46	0.614	0.276	ECOS2HP271EA							
330	35 x 45	1.99	2.79	0.502	0.251	ECOS2HP331EA							
390	35 x 50	2.22	3.11	0.425	0.234	ECOS2HP391EA							
330	40 x 40	2.16	3.02	0.502	0.276	ECOS2HP331FA							
470	40 x 50	2.70	3.78	0.353	0.194	ECOS2HP471FA							

TS-HA Series two terminal snap-in

- 3000 hour* life at 105°C with high ripple current capability
- Wide range of case sizes including 20mm, low profile lengths
- **NEW:** 40mm diameter sizes through 100WV.
- Can vent construction



Rated Working Voltage:	10 ~ 250 VDC	385 ~ 450 VDC
Operating Temperature:	-40 ~ +105°C	-25 ~ +105°C
Nominal Capacitance:	68 ~ 68000µF (±20% tolerance)	33 ~ 470µF (±20% tolerance)
Dissipation Factor: (120 Hz, +20°C)	Working Voltage [V]:	10 16 25 35 50 63 80 100 - 450
	Max. D.F. (%):	55 45 35 30 25 20 17 15
For capacitance values > 33000µF, add the value of: $\frac{\text{(rated cap. } [\mu\text{F}] - 33000)}{1000}$		
Endurance:	3000 hours* at +105°C with maximum specified ripple current (see page 4) *2000 hours for 20mm diameter or 20mm length sizes	

Part Number System

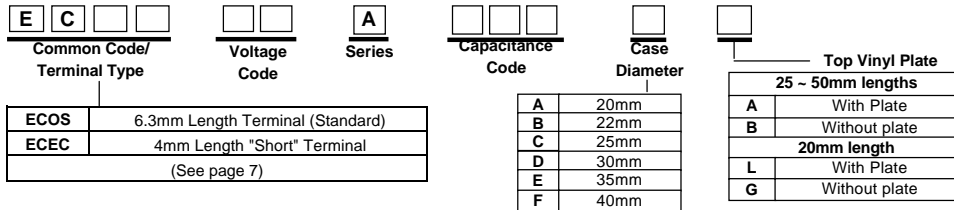

TS-HA Standard Ratings

Cap. (µF)	Size (mm) D x L	Max 105°C R.C. (A _{rms})		20°C ESR (Ω, max.)		Panasonic Part Number
		120Hz	10k-50kHz	120Hz	20kHz	
10 VDC Working, 13 VDC Surge						
6800	20 x 25	1.30	1.50	0.110	0.093	ECOS1AA682AA
8200	20 x 30	1.60	1.84	0.091	0.077	ECOS1AA822AA
10000	20 x 30	1.80	2.07	0.075	0.063	ECOS1AA103AA
12000	20 x 35	2.20	2.53	0.062	0.053	ECOS1AA123AA
15000	20 x 40	2.30	2.65	0.053	0.045	ECOS1AA153AA
10000	22 x 25	1.80	2.07	0.075	0.063	ECOS1AA103BA
12000	22 x 30	2.20	2.53	0.062	0.053	ECOS1AA123BA
15000	22 x 35	2.30	2.65	0.053	0.045	ECOS1AA153BA
18000	22 x 40	2.40	2.76	0.044	0.038	ECOS1AA183BA
22000	22 x 45	2.60	2.99	0.038	0.032	ECOS1AA223BA
27000	22 x 50	3.10	3.57	0.033	0.028	ECOS1AA273BA
15000	25 x 25	2.30	2.65	0.053	0.045	ECOS1AA153CA
18000	25 x 30	2.40	2.76	0.044	0.038	ECOS1AA183CA
22000	25 x 35	2.60	2.99	0.038	0.032	ECOS1AA223CA
27000	25 x 40	3.10	3.57	0.033	0.028	ECOS1AA273CA
33000	25 x 45	3.40	3.91	0.027	0.023	ECOS1AA333CA
39000	25 x 50	3.70	4.26	0.025	0.021	ECOS1AA393CA
22000	30 x 25	2.60	2.99	0.038	0.032	ECOS1AA223DA
27000	30 x 30	3.10	3.57	0.033	0.028	ECOS1AA273DA
33000	30 x 35	3.40	3.91	0.027	0.023	ECOS1AA333DA
39000	30 x 40	3.70	4.26	0.025	0.021	ECOS1AA393DA
47000	30 x 45	4.20	4.83	0.023	0.020	ECOS1AA473DA
56000	30 x 50	5.00	5.75	0.022	0.019	ECOS1AA563DA
27000	35 x 25	3.10	3.57	0.033	0.028	ECOS1AA273EA
33000	35 x 30	3.40	3.91	0.027	0.023	ECOS1AA333EA
39000	35 x 30	3.70	4.26	0.025	0.021	ECOS1AA393EA
47000	35 x 35	4.20	4.83	0.023	0.020	ECOS1AA473EA
56000	35 x 40	5.00	5.75	0.022	0.021	ECOS1AA563EA
68000	35 x 50	5.50	6.33	0.021	0.020	ECOS1AA683EA
62000	40 x 40	5.42	6.23	0.023	0.022	ECOS1AA623FA
82000	40 x 50	7.36	8.46	0.018	0.017	ECOS1AA823FA

Cap. (µF)	Size (mm) D x L	Max 105°C R.C. (A _{rms})		20°C ESR (Ω, max.)		Panasonic Part Number
		120Hz	10k-50kHz	120Hz	20kHz	
16 VDC Working, 20 VDC Surge						
6800	20 x 30	2.20	2.53	0.085	0.068	ECOS1CA682AA
8200	20 x 35	2.40	2.76	0.071	0.057	ECOS1CA822AA
10000	20 x 40	2.60	2.99	0.066	0.053	ECOS1CA103AA
3300	22 x 20	1.30	1.50	0.216	0.173	ECOS1CA332BL
6800	22 x 25	2.20	2.53	0.085	0.068	ECOS1CA682BA
8200	22 x 30	2.40	2.76	0.071	0.057	ECOS1CA822BA
10000	22 x 30	2.60	2.99	0.066	0.053	ECOS1CA103BA
12000	22 x 35	2.90	3.34	0.055	0.044	ECOS1CA123BA
15000	22 x 40	3.20	3.68	0.046	0.037	ECOS1CA153BA
18000	22 x 45	3.50	4.03	0.040	0.034	ECOS1CA183BA
4700	25 x 20	1.60	1.84	0.152	0.121	ECOS1CA472CL
10000	25 x 25	2.60	2.99	0.066	0.053	ECOS1CA103CA
12000	25 x 30	2.90	3.34	0.055	0.044	ECOS1CA123CA
15000	25 x 35	3.20	3.68	0.046	0.037	ECOS1CA153CA
18000	25 x 40	3.50	4.03	0.040	0.034	ECOS1CA183CA
22000	25 x 45	3.80	4.37	0.033	0.028	ECOS1CA223CA
27000	25 x 50	4.20	4.83	0.028	0.025	ECOS1CA273CA
6800	30 x 20	1.80	2.07	0.105	0.084	ECOS1CA682DL
12000	30 x 25	2.90	3.34	0.055	0.044	ECOS1CA123DA
15000	30 x 30	3.20	3.68	0.046	0.037	ECOS1CA153DA
18000	30 x 30	3.50	4.03	0.040	0.034	ECOS1CA183DA
22000	30 x 35	3.80	4.37	0.033	0.028	ECOS1CA223DA
27000	30 x 40	4.20	4.83	0.028	0.025	ECOS1CA273DA
33000	30 x 45	4.70	5.41	0.023	0.020	ECOS1CA333DA
39000	30 x 50	5.10	5.87	0.022	0.020	ECOS1CA393DA
10000	35 x 20	2.40	2.76	0.071	0.057	ECOS1CA103EL
18000	35 x 25	3.50	4.03	0.040	0.034	ECOS1CA183EA
22000	35 x 30	3.80	4.37	0.033	0.028	ECOS1CA223EA
27000	35 x 30	4.20	4.83	0.028	0.025	ECOS1CA273EA
33000	35 x 35	4.70	5.41	0.023	0.020	ECOS1CA333EA
39000	35 x 40	5.10	5.87	0.022	0.020	ECOS1CA393EA
47000	35 x 45	5.50	6.33	0.020	0.018	ECOS1CA473EA
56000	35 x 50	6.00	6.90	0.019	0.017	ECOS1CA563EA
47000	40 x 40	5.50	6.33	0.020	0.018	ECOS1CA473FA
68000	40 x 50	7.29	8.38	0.015	0.014	ECOS1CA683FA

TS-HB Series two terminal snap-in



- Very compact size (20 ~ 25% smaller than TS-HA series)
- Long 3000 hour life at 105°C with high ripple current capability
- **NEW:** 40mm diameter case sizes
- Can vent construction

Rated Working Voltage:	160 ~ 250 VDC	385 ~ 450 VDC
Operating Temperature:	-40 ~ +105°C	-25 ~ +105°C
Nominal Capacitance:	330 ~ 2700µF (±20%)	82 ~ 560µF (±20%)
Dissipation Factor: (120 Hz, +20°C)	Working Voltage [V]:	160 ~ 450
	Max. D.F. (%):	15
Endurance:	3000 hours at +105°C with maximum specified ripple current (see page 4)	

Part Number System

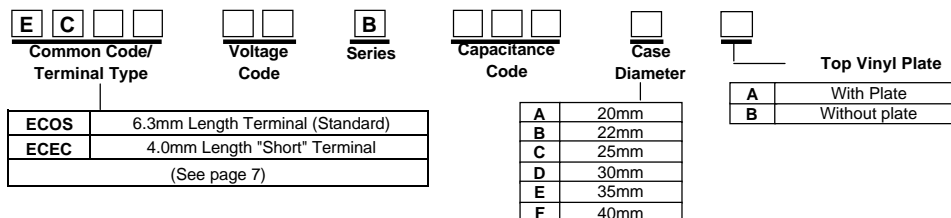

TS-HB Standard Ratings

Cap. (µF)	Size (mm) D x L	Max 105°C R.C. (A _{rms})		20°C ESR (Ω, max.)		Panasonic Part Number	Cap.	Size (mm) D x L	Max 105°C R.C. (A _{rms})		20°C ESR (Ω, max.)		Panasonic Part Number
		120Hz	10k-50kHz	120Hz	20kHz				120Hz	10k-50kHz	120Hz	20kHz	
160 VDC Working, 200 VDC Surge							200 VDC Working, 250 VDC Surge						
470	22 x 30	1.40	1.96	0.423	0.190	ECOS2CB471BA	390	22 x 30	1.30	1.82	0.510	0.230	ECOS2DB391BA
560	22 x 35	1.50	2.10	0.355	0.160	ECOS2CB561BA	470	22 x 35	1.40	1.96	0.423	0.190	ECOS2DB471BA
680	22 x 40	1.70	2.38	0.293	0.132	ECOS2CB681BA	560	22 x 40	1.50	2.10	0.355	0.160	ECOS2DB561BA
820	22 x 45	2.00	2.80	0.243	0.109	ECOS2CB821BA	680	22 x 45	1.70	2.38	0.293	0.132	ECOS2DB681BA
1000	22 x 50	2.20	3.08	0.199	0.090	ECOS2CB102BA	390	25 x 25	1.30	1.82	0.510	0.230	ECOS2DB391CA
680	25 x 30	1.70	2.38	0.293	0.132	ECOS2CB681CA	470	25 x 30	1.40	1.96	0.423	0.190	ECOS2DB471CA
820	25 x 35	2.00	2.80	0.243	0.109	ECOS2CB821CA	560	25 x 30	1.50	2.10	0.355	0.160	ECOS2DB561CA
1000	25 x 40	2.20	3.08	0.199	0.090	ECOS2CB102CA	680	25 x 35	1.70	2.38	0.293	0.132	ECOS2DB681CA
1200	25 x 45	2.30	3.22	0.180	0.090	ECOS2CB122CA	820	25 x 45	2.00	2.80	0.263	0.118	ECOS2DB821CA
1000	30 x 30	2.20	3.08	0.199	0.090	ECOS2CB102DA	1000	25 x 50	2.20	3.08	0.216	0.108	ECOS2DB102CA
1200	30 x 35	2.30	3.22	0.180	0.090	ECOS2CB122DA	560	30 x 25	1.50	2.10	0.355	0.160	ECOS2DB561DA
1500	30 x 40	2.50	3.50	0.144	0.072	ECOS2CB152DA	820	30 x 30	2.00	2.80	0.263	0.118	ECOS2DB821DA
1800	30 x 45	2.70	3.78	0.129	0.064	ECOS2CB182DA	1000	30 x 35	2.20	3.08	0.216	0.108	ECOS2DB102DA
1000	35 x 25	2.20	3.08	0.199	0.090	ECOS2CB102EA	1200	30 x 40	2.30	3.22	0.193	0.097	ECOS2DB122DA
1200	35 x 30	2.30	3.22	0.180	0.090	ECOS2CB122EA	1500	30 x 50	2.50	3.50	0.155	0.077	ECOS2DB152DA
1500	35 x 30	2.50	3.50	0.144	0.072	ECOS2CB152EA	820	35 x 25	2.00	2.80	0.263	0.118	ECOS2DB821EA
1800	35 x 35	2.70	3.78	0.129	0.064	ECOS2CB182EA	1000	35 x 30	2.20	3.08	0.216	0.108	ECOS2DB102EA
2200	35 x 45	2.90	4.06	0.105	0.063	ECOS2CB222EA	1200	35 x 35	2.30	3.22	0.193	0.097	ECOS2DB122EA
2700	35 x 50	3.10	4.34	0.086	0.052	ECOS2CB272EA	1500	35 x 40	2.50	3.50	0.155	0.077	ECOS2DB152EA
2200	40 x 40	2.90	4.06	0.105	0.063	ECOS2CB222FA	1800	35 x 45	2.70	3.78	0.129	0.077	ECOS2DB182EA
3300	40 x 50	3.36	4.70	0.070	0.042	ECOS2CB332FA	2200	35 x 50	2.90	4.06	0.105	0.063	ECOS2DB222EA
							1800	40 x 40	2.70	3.78	0.129	0.077	ECOS2DB182FA
							2700	40 x 50	3.55	4.97	0.086	0.052	ECOS2DB272FA

TS-HB Standard Ratings (continued)

Cap. (μ F)	Size (mm) D x L	Max 105°C R.C. (A_{rms})		20°C ESR (Ω , max.)		Panasonic Part Number	Cap. (μ F)	Size (mm) D x L	Max 105°C R.C. (A_{rms})		20°C ESR (Ω , max.)		Panasonic Part Number
		120Hz	10k-50kHz	120Hz	20kHz				120Hz	10k-50kHz	120Hz	20kHz	
250 VDC Working, 300 VDC Surge							385 VDC Working, 435 VDC Surge						
180	22 x 25	0.90	1.26	0.921	0.461	ECOS2EB181BA	82	22 x 30	0.64	0.90	2.022	0.809	ECOS2TB820BA
220	22 x 30	1.00	1.40	0.754	0.377	ECOS2EB221BA	100	22 x 30	0.69	0.97	1.658	0.663	ECOS2TB101BA
270	22 x 35	1.10	1.54	0.614	0.307	ECOS2EB271BA	120	22 x 35	0.75	1.05	1.382	0.553	ECOS2TB121BA
330	22 x 40	1.20	1.68	0.502	0.251	ECOS2EB331BA	150	22 x 40	0.82	1.15	1.105	0.442	ECOS2TB151BA
390	22 x 45	1.30	1.82	0.425	0.213	ECOS2EB391BA	180	22 x 45	0.95	1.33	0.921	0.368	ECOS2TB181BA
470	22 x 50	1.40	1.96	0.353	0.176	ECOS2EB471BA	100	25 x 25	0.69	0.97	1.658	0.663	ECOS2TB101CA
330	25 x 30	1.20	1.68	0.502	0.251	ECOS2EB331CA	120	25 x 30	0.75	1.05	1.382	0.553	ECOS2TB121CA
470	25 x 40	1.40	1.96	0.353	0.176	ECOS2EB471CA	150	25 x 30	0.82	1.15	1.105	0.442	ECOS2TB151CA
560	25 x 45	1.50	2.10	0.296	0.148	ECOS2EB561CA	180	25 x 35	0.95	1.33	0.921	0.368	ECOS2TB181CA
680	25 x 50	1.70	2.38	0.244	0.134	ECOS2EB681CA	220	25 x 45	1.10	1.54	0.754	0.301	ECOS2TB221CA
390	30 x 25	1.30	1.82	0.425	0.213	ECOS2EB391DA	270	25 x 50	1.20	1.68	0.675	0.270	ECOS2TB271CA
470	30 x 30	1.40	1.96	0.353	0.176	ECOS2EB471DA	150	30 x 25	0.82	1.15	1.105	0.442	ECOS2TB151DA
680	30 x 40	1.70	2.38	0.244	0.134	ECOS2EB681DA	180	30 x 30	0.95	1.33	0.921	0.368	ECOS2TB181DA
820	30 x 45	2.00	2.80	0.202	0.111	ECOS2EB821DA	220	30 x 30	1.10	1.54	0.829	0.332	ECOS2TB221DA
1000	30 x 50	2.20	3.08	0.199	0.109	ECOS2EB102DA	330	30 x 45	1.35	1.89	0.553	0.221	ECOS2TB331DA
560	35 x 25	1.50	2.10	0.296	0.148	ECOS2EB561EA	390	30 x 50	1.55	2.17	0.510	0.204	ECOS2TB391DA
680	35 x 30	1.70	2.38	0.244	0.134	ECOS2EB681EA	220	35 x 25	1.10	1.54	0.829	0.332	ECOS2TB221EA
820	35 x 35	2.00	2.80	0.202	0.111	ECOS2EB821EA	270	35 x 30	1.20	1.68	0.675	0.270	ECOS2TB271EA
1000	35 x 40	2.20	3.08	0.199	0.109	ECOS2EB102EA	330	35 x 35	1.35	1.89	0.553	0.221	ECOS2TB331EA
1200	35 x 45	2.30	3.22	0.166	0.099	ECOS2EB122EA	470	35 x 45	1.75	2.45	0.423	0.212	ECOS2TB471EA
1500	35 x 50	2.50	3.50	0.144	0.093	ECOS2EB152EA	560	35 x 50	1.80	2.52	0.355	0.178	ECOS2TB561EA
1200	40 x 40	2.66	3.72	0.180	0.117	ECOS2EB122FA	470	40 x 40	1.75	2.45	0.423	0.212	ECOS2TB471FA
1800	40 x 50	3.25	4.55	0.120	0.078	ECOS2EB182FA	680	40 x 50	2.10	2.94	0.293	0.146	ECOS2TB681FA
400 VDC Working, 450 VDC Surge							450 VDC Working, 500 VDC Surge						
82	22 x 30	0.64	0.90	2.022	0.708	ECOS2GB820BA	82	22 x 30	0.56	0.78	2.022	0.708	ECOS2WB820BA
100	22 x 30	0.69	0.97	1.658	0.580	ECOS2GB101BA	100	22 x 35	0.64	0.90	1.658	0.580	ECOS2WB101BA
120	22 x 35	0.75	1.05	1.382	0.484	ECOS2GB121BA	120	22 x 40	0.72	1.01	1.382	0.484	ECOS2WB121BA
150	22 x 40	0.82	1.15	1.105	0.387	ECOS2GB151BA	150	22 x 50	0.79	1.11	1.105	0.387	ECOS2WB151BA
180	22 x 45	0.95	1.33	0.921	0.322	ECOS2GB181BA	82	25 x 25	0.56	0.78	2.022	0.708	ECOS2WB820CA
100	25 x 25	0.69	0.97	1.658	0.580	ECOS2GB101CA	100	25 x 30	0.64	0.90	1.658	0.580	ECOS2WB101CA
120	25 x 30	0.75	1.05	1.382	0.484	ECOS2GB121CA	120	25 x 35	0.72	1.01	1.382	0.484	ECOS2WB121CA
150	25 x 30	0.82	1.15	1.105	0.387	ECOS2GB151CA	150	25 x 40	0.79	1.11	1.105	0.387	ECOS2WB151CA
180	25 x 35	0.95	1.33	0.921	0.322	ECOS2GB181CA	180	25 x 45	0.87	1.22	0.921	0.322	ECOS2WB181CA
220	25 x 45	1.10	1.54	0.754	0.264	ECOS2GB221CA	220	25 x 50	1.00	1.40	0.754	0.264	ECOS2WB221CA
270	25 x 50	1.20	1.68	0.614	0.215	ECOS2GB271CA	120	30 x 25	0.72	1.01	1.382	0.484	ECOS2WB121DA
150	30 x 25	0.82	1.15	1.105	0.387	ECOS2GB151DA	150	30 x 30	0.79	1.11	1.105	0.387	ECOS2WB151DA
180	30 x 30	0.95	1.33	0.921	0.322	ECOS2GB181DA	180	30 x 35	0.87	1.22	0.921	0.322	ECOS2WB181DA
220	30 x 30	1.10	1.54	0.754	0.264	ECOS2GB221DA	220	30 x 40	1.00	1.40	0.754	0.264	ECOS2WB221DA
270	30 x 35	1.20	1.68	0.614	0.215	ECOS2GB271DA	270	30 x 45	1.19	1.67	0.614	0.215	ECOS2WB271DA
330	30 x 45	1.35	1.89	0.502	0.201	ECOS2GB331DA	330	30 x 50	1.38	1.93	0.502	0.176	ECOS2WB331DA
390	30 x 50	1.55	2.17	0.425	0.170	ECOS2GB391DA	150	35 x 25	0.79	1.11	1.105	0.387	ECOS2WB151EA
220	35 x 25	1.10	1.54	0.754	0.264	ECOS2GB221EA	220	35 x 30	1.00	1.40	0.754	0.264	ECOS2WB221EA
270	35 x 30	1.20	1.68	0.614	0.215	ECOS2GB271EA	270	35 x 35	1.19	1.67	0.614	0.215	ECOS2WB271EA
330	35 x 35	1.35	1.89	0.502	0.201	ECOS2GB331EA	330	35 x 40	1.38	1.93	0.502	0.176	ECOS2WB331EA
390	35 x 40	1.55	2.17	0.425	0.170	ECOS2GB391EA	390	35 x 45	1.55	2.17	0.425	0.149	ECOS2WB391EA
470	35 x 45	1.75	2.45	0.353	0.141	ECOS2GB471EA	470	35 x 50	1.74	2.44	0.353	0.123	ECOS2WB471EA
560	35 x 50	1.80	2.52	0.296	0.118	ECOS2GB561EA	390	40 x 40	1.68	2.35	0.425	0.170	ECOS2WB391FA
470	40 x 40	1.75	2.45	0.353	0.141	ECOS2GB471FA	560	40 x 50	2.17	3.04	0.296	0.118	ECOS2WB561FA
680	40 x 50	2.10	2.94	0.244	0.098	ECOS2GB681FA							

TS-XB Series two terminal snap-in

- 7000 hour life at 105°C
- Suitable for long life industrial applications
- Very compact size (40 ~ 60% smaller than TS - NXA series)
- Can vent construction



Rated Working Voltage:	160 ~ 250 VDC	315 ~ 450 VDC
Operating Temperature:	-40 ~ +105°C	-25 ~ +105°C
Nominal Capacitance:	180 ~ 2200µF	39 ~ 680µF
Capacitance Tolerance:	± 20%	
Dissipation Factor:	15% maximum (120Hz, +20°C)	
Endurance:	7000 hours at +105°C with maximum specified ripple current (see page 4)	

Part Number System

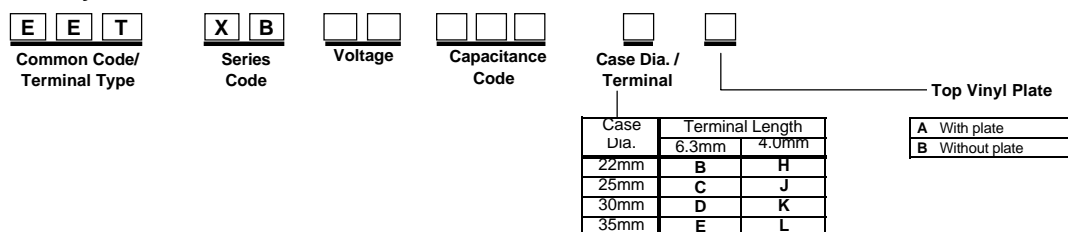

TS-XB Standard Ratings

Cap. (µF)	Size (mm) D x L	Max 105°C R.C. (A _{rms})		20°C ESR (Ω, max.)		Panasonic Part Number
		120Hz	10k-50kHz	120Hz	20kHz	
160 VDC Working, 200 VDC Surge						
270	22 x 25	1.10	1.54	0.655	0.295	EETXB2C271B□
330	22 x 30	1.20	1.68	0.536	0.241	EETXB2C331B□
390	22 x 30	1.30	1.82	0.453	0.204	EETXB2C391B□
470	22 x 35	1.40	1.96	0.376	0.169	EETXB2C471B□
560	22 x 40	1.50	2.10	0.316	0.142	EETXB2C561B□
680	22 x 45	1.70	2.38	0.260	0.117	EETXB2C681B□
390	25 x 25	1.30	1.82	0.453	0.204	EETXB2C391C□
470	25 x 30	1.40	1.96	0.376	0.169	EETXB2C471C□
560	25 x 30	1.50	2.10	0.316	0.142	EETXB2C561C□
680	25 x 35	1.70	2.38	0.260	0.117	EETXB2C681C□
820	25 x 40	2.00	2.80	0.216	0.097	EETXB2C821C□
1000	25 x 45	2.20	3.08	0.177	0.080	EETXB2C102C□
1200	25 x 50	2.30	3.22	0.160	0.080	EETXB2C122C□
560	30 x 25	1.50	2.10	0.316	0.142	EETXB2C561D□
680	30 x 30	1.70	2.38	0.260	0.117	EETXB2C681D□
820	30 x 30	2.00	2.80	0.216	0.097	EETXB2C821D□
1000	30 x 35	2.20	3.08	0.177	0.080	EETXB2C102D□
1200	30 x 40	2.30	3.22	0.160	0.080	EETXB2C122D□
1500	30 x 45	2.50	3.50	0.128	0.064	EETXB2C152D□
1800	30 x 50	2.70	3.78	0.115	0.057	EETXB2C182D□
1200	35 x 35	2.30	3.22	0.160	0.080	EETXB2C122E□
1500	35 x 35	2.50	3.50	0.128	0.064	EETXB2C152E□
1800	35 x 40	2.70	3.78	0.115	0.057	EETXB2C182E□
2200	35 x 50	2.90	4.06	0.094	0.056	EETXB2C222E□
180 VDC Working, 225 VDC Surge						
220	22 x 25	1.00	1.40	0.804	0.36	EETXB2P221B□
270	22 x 25	1.10	1.54	0.655	0.29	EETXB2P271B□
330	22 x 30	1.20	1.68	0.536	0.24	EETXB2P331B□
390	22 x 30	1.30	1.82	0.453	0.20	EETXB2P391B□
470	22 x 35	1.40	1.96	0.376	0.17	EETXB2P471B□
560	22 x 40	1.50	2.10	0.316	0.14	EETXB2P561B□
680	22 x 50	1.70	2.38	0.260	0.12	EETXB2P681B□
330	25 x 25	1.20	1.68	0.536	0.24	EETXB2P331C□
390	25 x 25	1.30	1.82	0.453	0.20	EETXB2P391C□
470	25 x 30	1.40	1.96	0.376	0.17	EETXB2P471C□
560	25 x 35	1.50	2.10	0.316	0.14	EETXB2P561C□
680	25 x 40	1.70	2.38	0.260	0.12	EETXB2P681C□
820	25 x 45	2.00	2.80	0.216	0.10	EETXB2P821C□
470	30 x 25	1.40	1.96	0.376	0.17	EETXB2P471D□
560	30 x 25	1.50	2.10	0.316	0.14	EETXB2P561D□
680	30 x 30	1.70	2.38	0.260	0.12	EETXB2P681D□
820	30 x 35	2.00	2.80	0.234	0.11	EETXB2P821D□
1000	30 x 40	2.20	3.08	0.192	0.10	EETXB2P102D□
1200	30 x 45	2.30	3.22	0.160	0.08	EETXB2P122D□
1500	30 x 50	2.50	3.50	0.138	0.07	EETXB2P152D□
820	35 x 30	2.00	2.80	0.234	0.11	EETXB2P821E□
1000	35 x 30	2.20	3.08	0.192	0.10	EETXB2P102E□
1200	35 x 35	2.30	3.22	0.172	0.09	EETXB2P122E□
1500	35 x 40	2.50	3.50	0.138	0.07	EETXB2P152E□
1800	35 x 45	2.70	3.78	0.115	0.07	EETXB2P182E□
2200	35 x 50	2.90	4.06	0.094	0.06	EETXB2P222E□

TS-XB Standard Ratings (continued)

Cap. (μ F)	Size (mm) D x L	Max 105°C R.C. (A_{rms})		20°C ESR (Ω , max.)		Panasonic Part Number	Cap. (μ F)	Size (mm) D x L	Max 105°C R.C. (A_{rms})		20°C ESR (Ω , max.)		Panasonic Part Number
		120Hz	10k-50kHz	120Hz	20kHz				120Hz	10k-50kHz	120Hz	20kHz	
200 VDC Working, 250 VDC Surge							250 VDC Working, 300 VDC Surge						
220	22 x 25	1.00	1.40	0.804	0.36	EETXB2D221B□	180	22 x 30	0.90	1.26	0.819	0.41	EETXB2E181B□
270	22 x 30	1.10	1.54	0.655	0.29	EETXB2D271B□	220	22 x 30	1.00	1.40	0.670	0.33	EETXB2E221B□
330	22 x 30	1.20	1.68	0.536	0.24	EETXB2D331B□	270	22 x 35	1.10	1.54	0.546	0.27	EETXB2E271B□
390	22 x 35	1.30	1.82	0.453	0.20	EETXB2D391B□	330	22 x 40	1.20	1.68	0.447	0.22	EETXB2E331B□
470	22 x 40	1.40	1.96	0.376	0.17	EETXB2D471B□	390	22 x 45	1.30	1.82	0.378	0.19	EETXB2E391B□
560	22 x 45	1.50	2.10	0.316	0.14	EETXB2D561B□	180	25 x 25	0.90	1.26	0.819	0.41	EETXB2E181C□
270	25 x 25	1.10	1.54	0.655	0.29	EETXB2D271C□	220	25 x 25	1.00	1.40	0.670	0.33	EETXB2E221C□
330	25 x 25	1.20	1.68	0.536	0.24	EETXB2D331C□	270	25 x 30	1.10	1.54	0.546	0.27	EETXB2E271C□
390	25 x 30	1.30	1.82	0.453	0.20	EETXB2D391C□	330	25 x 35	1.20	1.68	0.447	0.22	EETXB2E331C□
470	25 x 35	1.40	1.96	0.376	0.17	EETXB2D471C□	390	25 x 35	1.30	1.82	0.378	0.19	EETXB2E391C□
560	25 x 35	1.50	2.10	0.316	0.14	EETXB2D561C□	470	25 x 45	1.40	1.96	0.314	0.16	EETXB2E471C□
680	25 x 40	1.70	2.38	0.260	0.12	EETXB2D681C□	560	25 x 50	1.50	2.10	0.263	0.13	EETXB2E561C□
820	25 x 50	2.00	2.80	0.216	0.10	EETXB2D821C□	270	30 x 25	1.10	1.54	0.546	0.27	EETXB2E271D□
390	30 x 25	1.30	1.82	0.453	0.20	EETXB2D391D□	330	30 x 25	1.20	1.68	0.447	0.22	EETXB2E331D□
470	30 x 30	1.40	1.96	0.376	0.17	EETXB2D471D□	390	30 x 30	1.30	1.82	0.378	0.19	EETXB2E391D□
560	30 x 30	1.50	2.10	0.316	0.14	EETXB2D561D□	470	30 x 35	1.40	1.96	0.314	0.16	EETXB2E471D□
680	30 x 35	1.70	2.38	0.260	0.12	EETXB2D681D□	560	30 x 35	1.50	2.10	0.263	0.13	EETXB2E561D□
820	30 x 40	2.00	2.80	0.216	0.10	EETXB2D821D□	680	30 x 45	1.70	2.38	0.217	0.12	EETXB2E681D□
1000	30 x 45	2.20	3.08	0.177	0.09	EETXB2D102D□	820	30 x 50	2.00	2.80	0.180	0.10	EETXB2E821D□
1200	30 x 50	2.30	3.22	0.160	0.08	EETXB2D122D□	470	35 x 30	1.40	1.96	0.314	0.16	EETXB2E471E□
820	35 x 30	2.00	2.80	0.216	0.10	EETXB2D821E□	560	35 x 30	1.50	2.10	0.263	0.13	EETXB2E561E□
1000	35 x 35	2.20	3.08	0.177	0.09	EETXB2D102E□	680	35 x 35	1.70	2.38	0.217	0.12	EETXB2E681E□
1200	35 x 40	2.30	3.22	0.160	0.08	EETXB2D122E□	820	35 x 40	2.00	2.80	0.180	0.10	EETXB2E821E□
1500	35 x 50	2.50	3.50	0.128	0.06	EETXB2D152E□	1000	35 x 45	2.20	3.08	0.177	0.10	EETXB2E102E□
							1200	35 x 50	2.30	3.22	0.147	0.09	EETXB2E122E□
315 VDC Working, 365 VDC Surge							350 VDC Working, 400 VDC Surge						
82	22 x 25	0.64	0.90	1.797	0.90	EETXB2F820B□	82	22 x 25	0.64	0.90	1.797	0.90	EETXB2V820B□
100	22 x 30	0.69	0.97	1.474	0.74	EETXB2F101B□	100	22 x 30	0.69	0.97	1.474	0.74	EETXB2V101B□
120	22 x 30	0.75	1.05	1.228	0.61	EETXB2F121B□	120	22 x 35	0.75	1.05	1.228	0.61	EETXB2V121B□
150	22 x 35	0.82	1.15	0.982	0.49	EETXB2F151B□	150	22 x 40	0.82	1.15	0.982	0.49	EETXB2V151B□
180	22 x 40	0.90	1.26	0.819	0.41	EETXB2F181B□	180	22 x 45	0.90	1.26	0.819	0.41	EETXB2V181B□
220	22 x 45	1.00	1.40	0.737	0.37	EETXB2F221B□	220	22 x 50	1.00	1.40	0.737	0.37	EETXB2V221B□
120	25 x 25	0.75	1.05	1.228	0.61	EETXB2F121C□	100	25 x 25	0.69	0.97	1.474	0.74	EETXB2V101C□
150	25 x 30	0.82	1.15	0.982	0.49	EETXB2F151C□	120	25 x 30	0.75	1.05	1.228	0.61	EETXB2V121C□
180	25 x 35	0.90	1.26	0.819	0.41	EETXB2F181C□	150	25 x 30	0.82	1.15	0.982	0.49	EETXB2V151C□
220	25 x 40	1.00	1.40	0.737	0.37	EETXB2F221C□	180	25 x 35	0.90	1.26	0.819	0.41	EETXB2V181C□
270	25 x 45	1.10	1.54	0.600	0.30	EETXB2F271C□	220	25 x 40	1.00	1.40	0.737	0.37	EETXB2V221C□
330	25 x 50	1.20	1.68	0.491	0.25	EETXB2F331C□	270	25 x 50	1.10	1.54	0.600	0.30	EETXB2V271C□
150	30 x 25	0.82	1.15	0.982	0.49	EETXB2F151D□	150	30 x 25	0.82	1.15	0.982	0.49	EETXB2V151D□
180	30 x 25	0.90	1.26	0.819	0.41	EETXB2F181D□	180	30 x 30	0.90	1.26	0.819	0.41	EETXB2V181D□
220	30 x 30	1.00	1.40	0.737	0.37	EETXB2F221D□	220	30 x 30	1.00	1.40	0.737	0.37	EETXB2V221D□
270	30 x 35	1.10	1.54	0.600	0.30	EETXB2F271D□	270	30 x 35	1.10	1.54	0.600	0.30	EETXB2V271D□
330	30 x 40	1.20	1.68	0.491	0.25	EETXB2F331D□	330	30 x 45	1.20	1.68	0.491	0.25	EETXB2V331D□
390	30 x 45	1.30	1.82	0.453	0.23	EETXB2F391D□	390	30 x 50	1.30	1.82	0.453	0.23	EETXB2V391D□
470	30 x 50	1.40	1.96	0.376	0.19	EETXB2F471D□	270	35 x 30	1.10	1.54	0.600	0.30	EETXB2V271E□
270	35 x 30	1.10	1.54	0.600	0.30	EETXB2F271E□	330	35 x 35	1.20	1.68	0.491	0.25	EETXB2V331E□
330	35 x 30	1.20	1.68	0.491	0.25	EETXB2F331E□	390	35 x 40	1.30	1.82	0.453	0.23	EETXB2V391E□
390	35 x 35	1.30	1.82	0.453	0.23	EETXB2F391E□	470	35 x 40	1.40	1.96	0.376	0.19	EETXB2V471E□
470	35 x 40	1.40	1.96	0.376	0.19	EETXB2F471E□	560	35 x 50	1.50	2.10	0.316	0.16	EETXB2V561E□
560	35 x 45	1.50	2.10	0.316	0.16	EETXB2F561E□							
680	35 x 50	1.70	2.38	0.260	0.14	EETXB2F681E□							

TS-XB Standard Ratings (continued)

Cap. (μ F)	Size (mm) D x L	Max 105°C R.C. (A_{rms})		20°C ESR (Ω , max.)		Panasonic Part Number	Cap. (μ F)	Size (mm) D x L	Max 105°C R.C. (A_{rms})		20°C ESR (Ω , max.)		Panasonic Part Number
		120Hz	10k-50kHz	120Hz	20kHz				120Hz	10k-50kHz	120Hz	20kHz	
400 VDC Working, 450 VDC Surge							450 VDC Working, 500 VDC Surge						
56	22 x 25	0.51	0.71	2.631	0.92	EETXB2G560B□	39	22 x 25	0.37	0.52	3.779	1.32	EETXB2W390B□
68	22 x 30	0.56	0.78	2.167	0.76	EETXB2G680B□	47	22 x 30	0.40	0.56	3.135	1.10	EETXB2W470B□
82	22 x 35	0.64	0.90	1.797	0.63	EETXB2G820B□	56	22 x 35	0.47	0.66	2.631	0.92	EETXB2W560B□
100	22 x 35	0.69	0.97	1.474	0.52	EETXB2G101B□	68	22 x 40	0.53	0.74	2.167	0.76	EETXB2W680B□
120	22 x 40	0.75	1.05	1.228	0.43	EETXB2G121B□	82	22 x 45	0.56	0.78	1.797	0.63	EETXB2W820B□
150	22 x 50	0.82	1.15	0.982	0.34	EETXB2G151B□	100	22 x 50	0.64	0.90	1.474	0.52	EETXB2W101B□
68	25 x 25	0.56	0.78	2.167	0.76	EETXB2G680C□	56	25 x 25	0.47	0.66	2.631	0.92	EETXB2W560C□
82	25 x 25	0.64	0.90	1.797	0.63	EETXB2G820C□	68	25 x 30	0.53	0.74	2.167	0.76	EETXB2W680C□
100	25 x 30	0.69	0.97	1.474	0.52	EETXB2G101C□	82	25 x 35	0.56	0.78	1.797	0.63	EETXB2W820C□
120	25 x 35	0.75	1.05	1.228	0.43	EETXB2G121C□	100	25 x 40	0.64	0.90	1.474	0.52	EETXB2W101C□
150	25 x 40	0.82	1.15	0.982	0.34	EETXB2G151C□	120	25 x 45	0.72	1.01	1.228	0.43	EETXB2W121C□
180	25 x 45	0.90	1.26	0.819	0.29	EETXB2G181C□	150	25 x 50	0.79	1.11	0.982	0.34	EETXB2W151C□
220	25 x 50	1.00	1.40	0.670	0.23	EETXB2G221C□	82	30 x 25	0.56	0.78	1.797	0.63	EETXB2W820D□
120	30 x 25	0.75	1.05	1.228	0.43	EETXB2G121D□	100	30 x 30	0.64	0.90	1.474	0.52	EETXB2W101D□
150	30 x 30	0.82	1.15	0.982	0.34	EETXB2G151D□	120	30 x 30	0.72	1.01	1.228	0.43	EETXB2W121D□
180	30 x 35	0.90	1.26	0.819	0.29	EETXB2G181D□	150	30 x 40	0.79	1.11	0.982	0.34	EETXB2W151D□
220	30 x 40	1.00	1.40	0.670	0.23	EETXB2G221D□	180	30 x 45	0.87	1.22	0.819	0.29	EETXB2W181D□
270	30 x 45	1.10	1.54	0.546	0.19	EETXB2G271D□	220	30 x 50	1.00	1.40	0.670	0.23	EETXB2W221D□
330	30 x 50	1.20	1.68	0.447	0.18	EETXB2G331D□	150	35 x 30	0.79	1.11	0.982	0.34	EETXB2W151E□
180	35 x 25	0.90	1.26	0.819	0.29	EETXB2G181E□	180	35 x 35	0.87	1.22	0.819	0.29	EETXB2W181E□
220	35 x 30	1.00	1.40	0.670	0.23	EETXB2G221E□	220	35 x 40	1.00	1.40	0.670	0.23	EETXB2W221E□
270	35 x 35	1.10	1.54	0.546	0.19	EETXB2G271E□	270	35 x 45	1.19	1.67	0.546	0.19	EETXB2W271E□
330	35 x 40	1.20	1.68	0.447	0.18	EETXB2G331E□	330	35 x 50	1.38	1.93	0.447	0.16	EETXB2W331E□
390	35 x 45	1.30	1.82	0.378	0.15	EETXB2G391E□							
470	35 x 50	1.40	1.96	0.314	0.13	EETXB2G471E□							

TS-EX Series two terminal snap-in

- High reliability design for abnormal overvoltage conditions
- 2000 hour, 105°C endurance with high ripple current capability
- VDE-0806 Specification

Specifications

Rated Working Voltage:	250 VDC
Operating Temperature:	-40 ~ +105°C
Nominal Capacitance:	100 ~ 1200μF
Dissipation Factor:	20% max. (120 Hz, +20°C)
Endurance:	2000 hours at +105°C with maximum specified ripple current (see page 4)
Overvoltage Characteristics:	Capacitor shall not vent or short-circuit when 360 VDC is applied for a time period of 7 hours; Condition A: 70°C ambient temperature Condition B: 35°C ambient temperature

Part Number System

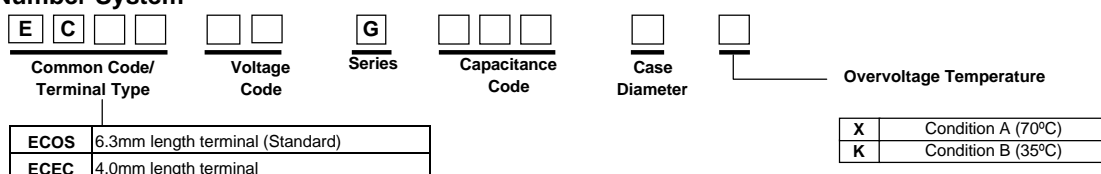

TS-EX Standard Ratings

Cap. (μF)	Size (mm) D x L	Max 105°C R.C. (A _{rms})		Max 20°C ESR (Ω)		Panasonic Part Number	Cap. (μF)	Size (mm) D x L	Max 105°C R.C. (A _{rms})		Max 20°C ESR (Ω)		Panasonic Part Number
		120Hz	10k-50kHz	120Hz	20kHz				120Hz	10k-50kHz	120Hz	20kHz	
250 VDC Working, Condition A (70°C)							250 VDC Working, Condition B (35°C)						
100	22 x 25	0.70	0.98	1.768	0.884	ECOS2EG101DX	120	22 x 25	0.75	1.05	1.474	0.737	ECOS2EG121DK
120	22 x 30	0.75	1.05	1.474	0.737	ECOS2EG121EX	150	22 x 30	0.80	1.12	1.179	0.589	ECOS2EG151EK
150	22 x 30	0.80	1.12	1.179	0.589	ECOS2EG151EX	180	22 x 30	0.90	1.26	0.982	0.491	ECOS2EG181EK
180	22 x 35	0.90	1.26	0.982	0.491	ECOS2EG181FX	220	22 x 35	1.00	1.40	0.804	0.402	ECOS2EG221FK
220	22 x 40	1.00	1.40	0.804	0.402	ECOS2EG221GX	270	22 x 40	1.10	1.54	0.655	0.327	ECOS2EG271GK
270	22 x 45	1.10	1.54	0.655	0.327	ECOS2EG271GX	330	22 x 45	1.20	1.68	0.536	0.268	ECOS2EG331GK
330	22 x 50	1.20	1.68	0.536	0.268	ECOS2EG331HX	390	22 x 50	1.30	1.82	0.453	0.227	ECOS2EG391HK
150	25 x 25	0.80	1.12	1.179	0.589	ECOS2EG151JX	180	25 x 25	0.90	1.26	0.982	0.491	ECOS2EG181JK
180	25 x 30	0.90	1.26	0.982	0.491	ECOS2EG181KX	220	25 x 30	1.00	1.40	0.804	0.402	ECOS2EG221KK
220	25 x 30	1.00	1.40	0.804	0.402	ECOS2EG221KX	270	25 x 30	1.10	1.54	0.655	0.327	ECOS2EG271KK
270	25 x 35	1.10	1.54	0.655	0.327	ECOS2EG271LX	330	25 x 35	1.20	1.68	0.536	0.268	ECOS2EG331LK
330	25 x 40	1.20	1.68	0.536	0.268	ECOS2EG331MX	390	25 x 40	1.30	1.82	0.453	0.227	ECOS2EG391MK
390	25 x 45	1.30	1.82	0.453	0.227	ECOS2EG391MX	470	25 x 45	1.40	1.96	0.376	0.188	ECOS2EG471NK
470	25 x 50	1.40	1.96	0.376	0.188	ECOS2EG471NX	560	25 x 50	1.50	2.10	0.316	0.158	ECOS2EG561NK
220	30 x 25	1.00	1.40	0.804	0.402	ECOS2EG221QX	270	30 x 25	1.10	1.54	0.655	0.327	ECOS2EG271QK
270	30 x 30	1.10	1.54	0.655	0.327	ECOS2EG271RX	330	30 x 30	1.20	1.68	0.536	0.268	ECOS2EG331RK
330	30 x 30	1.20	1.68	0.536	0.268	ECOS2EG331RX	390	30 x 30	1.30	1.82	0.453	0.227	ECOS2EG391RK
390	30 x 35	1.30	1.82	0.453	0.227	ECOS2EG391SX	470	30 x 35	1.40	1.96	0.376	0.188	ECOS2EG471RK
470	30 x 40	1.40	1.96	0.376	0.188	ECOS2EG471TX	560	30 x 40	1.50	2.10	0.316	0.158	ECOS2EG561TK
560	30 x 45	1.50	2.10	0.316	0.158	ECOS2EG561TX	680	30 x 45	1.70	2.38	0.260	0.130	ECOS2EG681TK
680	30 x 50	1.70	2.38	0.260	0.130	ECOS2EG681UX	820	30 x 50	2.00	2.80	0.216	0.108	ECOS2EG821UK
330	35 x 25	1.20	1.68	0.536	0.268	ECOS2EG331WX	390	35 x 25	1.30	1.82	0.453	0.227	ECOS2EG391WK
390	35 x 30	1.30	1.82	0.453	0.227	ECOS2EG391XX	470	35 x 30	1.40	1.96	0.376	0.188	ECOS2EG471XK
470	35 x 30	1.40	1.96	0.376	0.188	ECOS2EG471YX	560	35 x 30	1.50	2.10	0.316	0.158	ECOS2EG561XK
560	35 x 35	1.50	2.10	0.316	0.158	ECOS2EG561VX	680	35 x 35	1.70	2.38	0.260	0.130	ECOS2EG681VK
680	35 x 40	1.70	2.38	0.260	0.130	ECOS2EG681YX	820	35 x 40	2.00	2.80	0.216	0.108	ECOS2EG821YK
820	35 x 45	2.00	2.80	0.252	0.126	ECOS2EG821YX	1000	35 x 45	2.20	3.08	0.206	0.103	ECOS2EG102YK
1000	35 x 50	2.20	3.08	0.206	0.103	ECOS2EG102ZX	1200	35 x 50	2.30	3.22	0.172	0.086	ECOS2EG122ZK

T Type General Information

Dimensions

T Type $\phi 35$ & 40mm Diameters

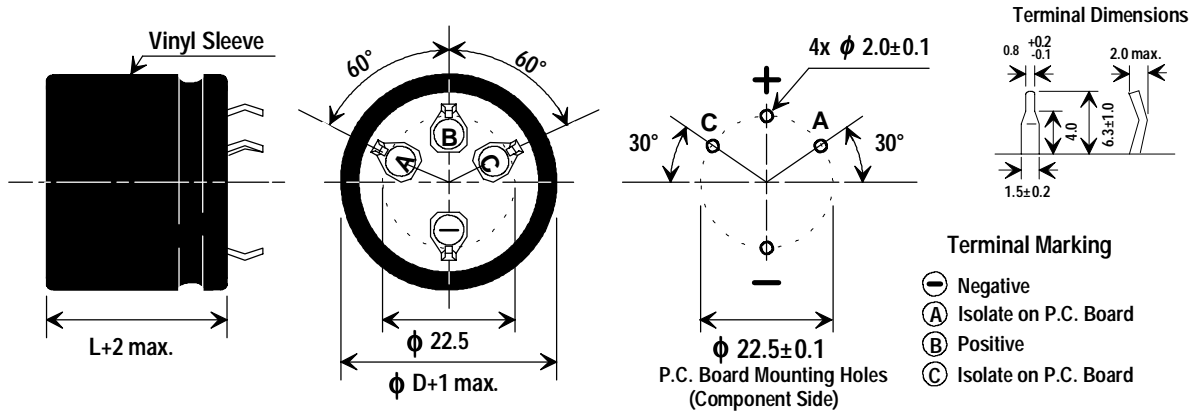

T Type $\phi 50$ mm Diameter

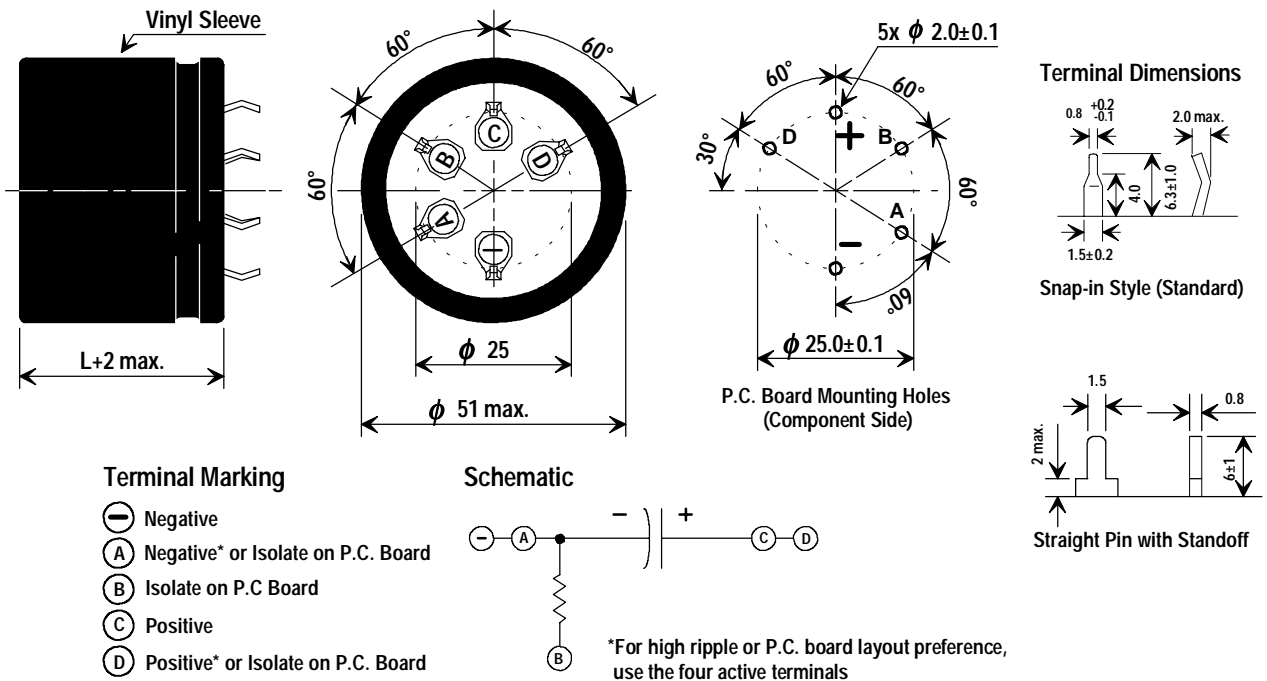

Ripple Current Multipliers

Ripple Current Frequency Correction Factors						
Frequency (Hz):	50	60	100~120	500	1k	10k~50k
16~100WV:	0.93	0.95	1.0	1.05	1.08	1.15
160~450WV:	0.75	0.8	1.0	1.2	1.25	1.4

Ripple Current Temperature Correction Factors					
Max. Temperature	105°C	85°C	70°C	60°C	≤45°C
T-UP	---	1.0	1.3	1.4	1.5
T-HA	1.0	1.7	2.0	2.2	2.35

Note: Use of temperature correction factors can limit load life to the hours specified for the maximum operating temperature of the series.

T-UP Series multi terminal snap-in

- **NEW** 50mm diameter sizes with five P. C. mount terminals
- **NEW** lengths up to 105mm
- Endurance rating of 3000 hours at 85°C
- 4 or 5 terminal mounting provides stability and keyed polarity
- Can vent construction



Rated Working Voltage:	16 ~ 250 VDC	350 ~ 500 VDC
Operating Temperature:	-40 ~ +85°C	-25 ~ +85°C
Nominal Capacitance:	1200 ~ 270000μF (±20% tolerance)	220 ~ 2700μF (±20% tolerance)
Endurance:	3000 hours at +85°C with maximum specified ripple current (see page 4)	

Part Number System

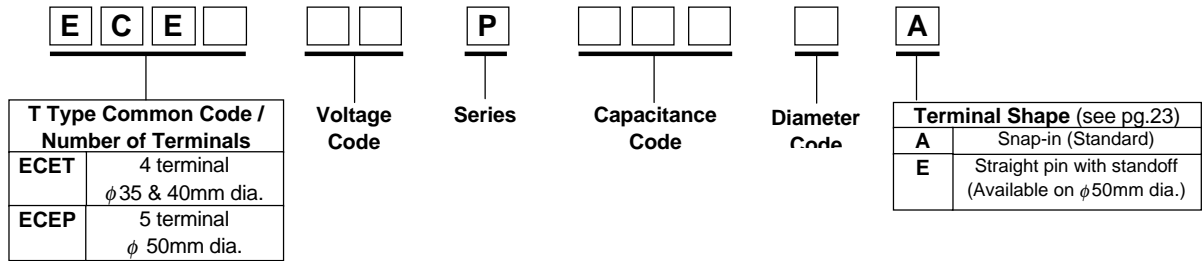

T-UP Standard Ratings

Cap. (μF)	Size (mm) D x L	Max 85°C R.C. (A _{rms})		Max 20°C E.S.R. (Ω)		Panasonic Part Number	Cap. (μF)	Size (mm) D x L	Max 85°C R.C. (A _{rms})		Max 20°C E.S.R. (Ω)		Panasonic Part Number
		120Hz	10k-50kHz	120Hz	20kHz				120Hz	10k-50kHz	120Hz	20kHz	
16 VDC Working, 20 VDC Surge							25 VDC Working, 32 VDC Surge						
47000	35 x 40	7.47	8.59	0.021	0.019	ECET1CP473EA	33000	35 x 40	6.84	7.87	0.019	0.015	ECET1EP333EA
68000	35 x 50	9.05	10.41	0.018	0.017	ECET1CP683EA	47000	35 x 50	8.00	9.20	0.014	0.012	ECET1EP473EA
82000	35 x 63	10.02	11.52	0.016	0.015	ECET1CP823EA	56000	35 x 63	8.85	10.18	0.015	0.013	ECET1EP563EA
100000	35 x 80	11.00	12.65	0.015	0.014	ECET1CP104EA	68000	35 x 80	10.43	11.99	0.013	0.011	ECET1EP683EA
120000	35 x 105	12.81	14.73	0.014	0.013	ECET1CP124EA	100000	35 x 105	11.97	13.77	0.010	0.008	ECET1EP104EA
56000	40 x 40	9.05	10.41	0.022	0.021	ECET1CP563FA	39000	40 x 40	8.00	9.20	0.020	0.018	ECET1EP393FA
82000	40 x 50	10.29	11.83	0.016	0.015	ECET1CP823FA	56000	40 x 50	8.96	10.30	0.016	0.015	ECET1EP563FA
100000	40 x 63	11.36	13.06	0.018	0.017	ECET1CP104FA	68000	40 x 63	10.25	11.79	0.017	0.015	ECET1EP683FA
120000	40 x 80	12.42	14.28	0.017	0.016	ECET1CP124FA	100000	40 x 80	12.08	13.89	0.012	0.011	ECET1EP104FA
180000	40 x 105	14.85	17.08	0.013	0.012	ECET1CP184FA	150000	40 x 105	14.07	16.18	0.011	0.010	ECET1EP154FA
120000	50 x 50	13.17	15.15	0.014	0.013	ECEP1CP124HA	82000	50 x 50	12.29	14.13	0.016	0.015	ECEP1EP823HA
150000	50 x 63	14.40	16.56	0.012	0.011	ECEP1CP154HA	100000	50 x 63	13.45	15.47	0.014	0.013	ECEP1EP104HA
180000	50 x 80	15.69	18.04	0.011	0.010	ECEP1CP184HA	120000	50 x 80	15.29	17.58	0.012	0.011	ECEP1EP124HA
220000	50 x 92	16.73	19.24	0.010	0.009	ECEP1CP224HA	150000	50 x 92	16.01	18.41	0.011	0.010	ECEP1EP154HA
270000	50 x 105	17.79	20.46	0.009	0.008	ECEP1CP274HA	180000	50 x 105	16.89	19.42	0.010	0.009	ECEP1EP184HA
35 VDC Working, 44 VDC Surge							50 VDC Working, 63 VDC Surge						
22000	35 x 40	6.10	7.02	0.026	0.020	ECET1VP223EA	15000	35 x 40	6.44	7.41	0.028	0.021	ECET1HP153EA
33000	35 x 50	7.15	8.22	0.018	0.014	ECET1VP333EA	22000	35 x 50	7.57	8.71	0.021	0.017	ECET1HP223EA
39000	35 x 63	7.94	9.13	0.015	0.012	ECET1VP393EA	27000	35 x 63	8.31	9.56	0.018	0.015	ECET1HP273EA
47000	35 x 80	9.53	10.96	0.014	0.011	ECET1VP473EA	33000	35 x 80	9.23	10.61	0.015	0.012	ECET1HP333EA
68000	35 x 105	10.62	12.21	0.010	0.008	ECET1VP683EA	47000	35 x 105	10.27	11.81	0.014	0.011	ECET1HP473EA
27000	40 x 40	6.84	7.87	0.021	0.017	ECET1VP273FA	18000	40 x 40	6.94	7.98	0.023	0.017	ECET1HP183FA
39000	40 x 50	7.98	9.18	0.017	0.014	ECET1VP393FA	27000	40 x 50	8.12	9.34	0.018	0.015	ECET1HP273FA
47000	40 x 63	9.58	11.02	0.016	0.013	ECET1VP473FA	33000	40 x 63	9.10	10.47	0.018	0.014	ECET1HP333FA
56000	40 x 80	10.30	11.85	0.015	0.012	ECET1VP563FA	39000	40 x 80	10.12	11.64	0.015	0.012	ECET1HP393FA
82000	40 x 105	12.02	13.82	0.012	0.009	ECET1VP823FA	56000	40 x 105	11.47	13.19	0.012	0.009	ECET1HP563FA
56000	50 x 50	10.94	12.58	0.015	0.012	ECEP1VP563HA	33000	50 x 50	10.48	12.05	0.018	0.014	ECEP1HP333HA
68000	50 x 63	11.93	13.72	0.013	0.011	ECEP1VP683HA	47000	50 x 63	11.54	13.27	0.013	0.010	ECEP1HP473HA
82000	50 x 80	13.06	15.02	0.012	0.010	ECEP1VP823HA	56000	50 x 80	12.46	14.33	0.012	0.009	ECEP1HP563HA
100000	50 x 92	13.97	16.07	0.011	0.009	ECEP1VP104HA	68000	50 x 92	13.17	15.15	0.011	0.009	ECEP1HP683HA
120000	50 x 105	14.86	17.09	0.010	0.008	ECEP1VP124HA	82000	50 x 105	13.87	15.95	0.011	0.008	ECEP1HP823HA

T-UP Standard Ratings (continued)

Cap. (μ F)	Size (mm) D x L	Max. 85°C R.C. (A_{rms})		Max. 20°C E.S.R. (Ω)		Panasonic Part Number
		120 Hz	10k-50kHz	120Hz	20kHz	
500 VDC Working, 550 VDC Surge						
270	35 x 40	1.76	2.46	0.614	0.276	ECET2HP271EA
390	35 x 50	2.22	3.11	0.425	0.234	ECET2HP391EA
470	35 x 63	2.58	3.61	0.353	0.194	ECET2HP471EA
680	35 x 80	3.21	4.49	0.244	0.134	ECET2HP681EA
820	35 x 105	3.97	5.56	0.202	0.111	ECET2HP821EA
330	40 x 40	2.16	3.02	0.502	0.276	ECET2HP331FA
470	40 x 50	2.70	3.78	0.353	0.194	ECET2HP471FA
560	40 x 63	3.11	4.35	0.326	0.179	ECET2HP561FA
820	40 x 80	3.88	5.43	0.222	0.122	ECET2HP821FA
1200	40 x 105	5.90	8.26	0.152	0.084	ECET2HP122FA
560	50 x 50	3.52	4.05	0.355	0.195	ECEP2HP561HA
680	50 x 63	4.07	5.70	0.293	0.161	ECEP2HP681HA
1000	50 x 80	5.05	7.07	0.199	0.109	ECEP2HP102HA
1200	50 x 92	5.74	8.04	0.166	0.091	ECEP2HP122HA
1500	50 x 105	6.65	9.31	0.144	0.079	ECEP2HP152HA

T-HA Series multi terminal snap-in

- **NEW** 50mm Diameter Sizes with Five P. C. Mount Terminals
- **NEW** lengths up to 105mm
- Endurance rating of 3000 hours at 105°C
- 4 or 5 terminal mounting provides stability and keyed polarity
- Can vent construction



Rated Working Voltage:	16 ~ 250 VDC	350 ~ 450 VDC
Operating Temperature:	-40 ~ +105°C	-25 ~ +105°C
Nominal Capacitance:	1000~ 250000µF (±20% tolerance)	330 ~ 2200µF (±20% tolerance)
Endurance:	3000 hours at +105°C with maximum specified ripple current (see page 4)	

Part Number System

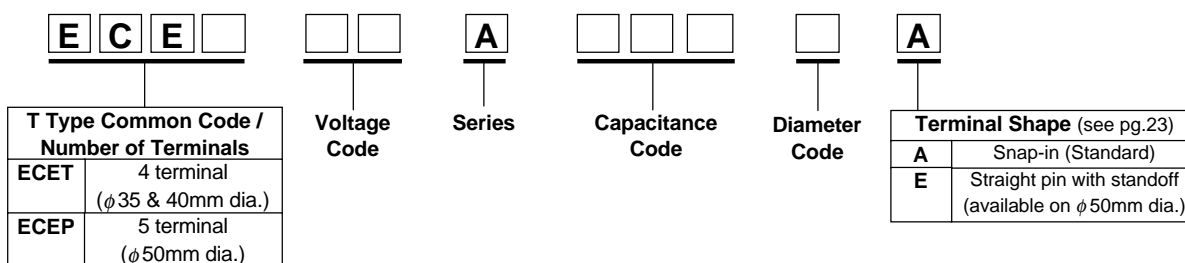

T-HA Standard Ratings

Cap. (µF)	Size (mm) D x L	Max 105°C R.C. (A _{rms})		Max 20°C ESR (Ω)		Panasonic Part Number	Cap. (µF)	Size (mm) D x L	Max 105°C R.C. (A _{rms})		Max 20°C ESR (Ω)		Panasonic Part Number
		120 Hz	10k-50kHz	120Hz	20kHz				120Hz	20kHz			
16 VDC Working, 20 VDC Surge							25 VDC Working, 32 VDC Surge						
39000	35 x 40	5.10	5.87	0.022	0.020	ECET1CA393EA	27000	35 x 40	4.80	5.52	0.018	0.017	ECET1EA273EA
56000	35 x 50	6.00	6.90	0.019	0.017	ECET1CA563EA	33000	35 x 50	5.50	6.33	0.018	0.016	ECET1EA333EA
68000	35 x 63	6.62	7.61	0.017	0.015	ECET1CA683EA	47000	35 x 63	6.56	7.54	0.017	0.015	ECET1EA473EA
100000	35 x 80	8.03	9.23	0.015	0.013	ECET1CA104EA	56000	35 x 80	7.25	8.34	0.015	0.013	ECET1EA563EA
120000	35 x 105	8.71	10.02	0.014	0.012	ECET1CA124EA	82000	35 x 105	8.58	9.87	0.013	0.012	ECET1EA823EA
47000	40 x 40	5.50	6.33	0.020	0.018	ECET1CA473FA	33000	40 x 40	5.50	6.33	0.018	0.016	ECET1EA333FA
68000	40 x 50	7.29	8.38	0.015	0.014	ECET1CA683FA	47000	40 x 50	6.47	7.44	0.015	0.014	ECET1EA473FA
82000	40 x 63	7.66	8.81	0.017	0.015	ECET1CA823FA	56000	40 x 63	7.17	8.25	0.014	0.013	ECET1EA563FA
120000	40 x 80	8.79	10.11	0.014	0.012	ECET1CA124FA	82000	40 x 80	8.68	9.98	0.013	0.012	ECET1EA823FA
150000	40 x 105	9.88	11.36	0.013	0.012	ECET1CA154FA	100000	40 x 105	9.76	11.22	0.012	0.010	ECET1EA104FA
120000	50 x 50	9.02	10.37	0.015	0.014	ECEP1CA124HA	82000	50 x 50	9.20	10.58	0.016	0.015	ECEP1EA823HA
150000	50 x 63	10.15	11.67	0.014	0.013	ECEP1CA154HA	100000	50 x 63	10.02	11.52	0.015	0.013	ECEP1EA104HA
180000	50 x 80	11.02	12.67	0.013	0.012	ECEP1CA184HA	120000	50 x 80	10.93	12.57	0.013	0.012	ECEP1EA124HA
220000	50 x 92	11.71	13.47	0.012	0.011	ECEP1CA224HA	150000	50 x 92	11.70	13.46	0.012	0.011	ECEP1EA154HA
250000	50 x 105	12.31	14.16	0.011	0.010	ECEP1CA254HA	180000	50 x 105	12.42	14.28	0.010	0.009	ECEP1EA184HA
35 VDC Working, 44 VDC Surge							50 VDC Working, 63 VDC Surge						
18000	35 x 40	4.30	4.95	0.028	0.021	ECET1VA183EA	10000	35 x 40	4.00	4.60	0.033	0.025	ECET1HA103EA
22000	35 x 50	5.00	5.75	0.023	0.017	ECET1VA223EA	15000	35 x 50	4.80	5.52	0.022	0.018	ECET1HA153EA
27000	35 x 63	5.53	6.36	0.025	0.018	ECET1VA273EA	18000	35 x 63	5.27	6.06	0.020	0.016	ECET1HA183EA
39000	35 x 80	6.52	7.50	0.019	0.014	ECET1VA393EA	27000	35 x 80	6.16	7.08	0.015	0.012	ECET1HA273EA
47000	35 x 105	8.07	9.28	0.017	0.013	ECET1VA473EA	33000	35 x 105	7.23	8.31	0.013	0.010	ECET1HA333EA
22000	40 x 40	5.00	5.75	0.023	0.017	ECET1VA223FA	15000	40 x 40	4.80	5.52	0.022	0.018	ECET1HA153FA
27000	40 x 50	5.44	6.26	0.020	0.015	ECET1VA273FA	22000	40 x 50	5.15	5.92	0.016	0.013	ECET1HA223FA
33000	40 x 63	6.61	7.60	0.019	0.014	ECET1VA333FA	27000	40 x 63	6.05	6.96	0.015	0.012	ECET1HA273FA
47000	40 x 80	7.79	8.96	0.018	0.013	ECET1VA473FA	39000	40 x 80	7.55	8.68	0.014	0.011	ECET1HA393FA
68000	40 x 105	9.27	10.66	0.016	0.012	ECET1VA683FA	47000	40 x 105	8.18	9.41	0.012	0.010	ECET1HA473FA
47000	50 x 50	8.25	9.49	0.021	0.016	ECEP1VA473HA	33000	50 x 50	7.75	8.91	0.018	0.014	ECEP1HA333HA
56000	50 x 63	9.07	10.43	0.019	0.014	ECEP1VA563HA	39000	50 x 63	8.40	9.66	0.016	0.013	ECEP1HA393HA
68000	50 x 80	10.07	11.58	0.017	0.013	ECEP1VA683HA	47000	50 x 80	9.19	10.57	0.014	0.011	ECEP1HA473HA
82000	50 x 92	10.89	12.52	0.015	0.011	ECEP1VA823HA	56000	50 x 92	9.79	11.26	0.012	0.009	ECEP1HA563HA
100000	50 x 105	11.75	13.51	0.013	0.010	ECEP1VA104HA	68000	50 x 105	10.42	11.98	0.011	0.009	ECEP1HA683HA

G Type General Information

Dimensions (mm)

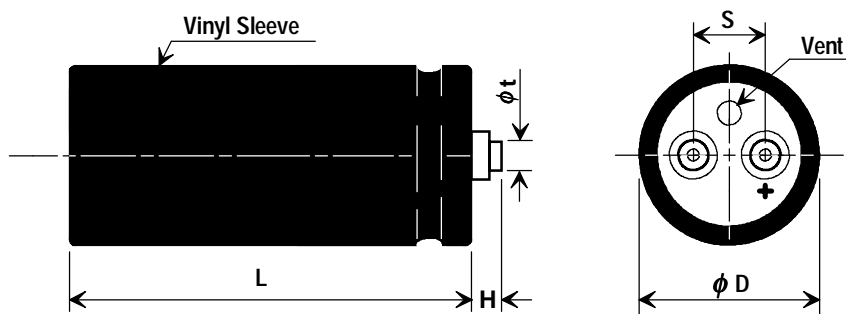

Case Code	Nominal Size D x L	Sleeved Case Dimensions		
		$\phi D \pm 0.79$	$L \pm 1.58$	$S \pm 0.41$
CA	35 x 41	35.4	42.1	12.7
CC	35 x 54		54.8	
CE	35 x 67		67.5	
CG	35 x 79		80.2	
CH	35 x 92		92.9	
CK	35 x 105		105.6	
CL	35 x 117		118.3	
CN	35 x 130		131.0	
CP	35 x 143		143.7	
FB	51 x 48		51.3	
FC	51 x 54	54.8		
FE	51 x 67	67.5		
FG	51 x 79	80.2		
FH	51 x 92	92.9		
FK	51 x 105	105.6		
FL	51 x 117	118.3		
FN	51 x 130	131.0		
FP	51 x 143	143.7		
GG	64 x 79	64.0		80.2
GH	64 x 92		92.9	
GK	64 x 105		105.6	
GL	64 x 130		118.3	
GN	64 x 130		131.0	
GP	64 x 143		143.7	
HW	76 x 219		76.7	80.2
HH	76 x 92	92.9		
HK	76 x 105	105.6		
HL	76 x 117	118.3		
HN	76 x 130	131.0		
HP	76 x 143	143.7		
HW	76 x 219	219.9		

Terminal Specifications				
Terminal Code	Thread	Thread Depth	$H \pm 0.79$	$\phi t \pm 0.25$
E	10-32 NF-2B	9.5	6.4	8.0
L	10-32 NF-2B	5.5	1.6	8.0
M	M5	9.5	6.4	8.0
H	1/4-28 NF-2B	11.9	6.4	17.4
J	1/4-28 NF-2B	8.7	2.8	17.4
X	M6	11.9	6.4	17.4
Y	M6	8.7	2.8	17.4

Terminal Availability by Diameter					
Terminal Code	Nominal Diameter				Max. ripple current (A)
	35mm	51mm	64mm	76mm	
E	S	S	S	S	30
L	O	O	O	O	
M	O	O	O	O	
H	N.A.	N.A.	O	O	50
J	N.A.	N.A.	O	O	
X	N.A.	N.A.	O	O	
Y	N.A.	N.A.	O	O	

S: standard O: optional N.A.: not available

Ripple Current Multipliers

Ripple Current Frequency Correction Factors						
Frequency (Hz):	50	60	100~120	300~360	1k	10k~50k
16~100 WV:	0.9	0.95	1.0	1.05	1.08	1.15
160~500 WV:	0.75	0.8	1.0	1.2	1.25	1.4

Ripple Current Temperature Correction Factors					
Max. Temperature	105°C	85°C	70°C	60°C	≤45°C
G-AA	---	1.0	1.6	2.0	2.2
G-BA	1.0	1.75	2.0	2.2	2.35

Note: Use of temperature correction factors can limit load life to the hours specified for the maximum operating temperature of the series.

G-AA Series screw terminal style

- General purpose for industrial applications
- High ripple current with 3000 hour life
- High CV designs
- Customized designs available



Rated Working Voltage:	16 ~ 500 VDC
Operating Temperature:	-40 ~ +85°C
Nominal Capacitance:	150 ~ 1200000μF
Capacitance Tolerance:	± 20%
Endurance:	3000 hours at +85°C with maximum specified ripple current (see page 4)

Part Number System

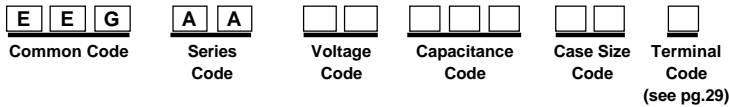

G-AA Typical Ratings

Cap. (μF)	Nominal Size D x L (mm)	Max 85°C R.C. (A _{rms})		20°C ESR (Ω, max.)		Panasonic Part Number	Cap. (μF)	Nominal Size D x L (mm)	Max 85°C R.C. (A _{rms})		20°C ESR (Ω, max.)		Panasonic Part Number
		120Hz	10k-50kHz	120Hz	20kHz				120Hz	10k-50kHz	120Hz	20kHz	
16 VDC Working, 20 VDC Surge							20 VDC Working, 24 VDC Surge						
33000	35 x 41	5.16	5.93	0.0313	0.0281	EEGAA1C333CA□	27000	35 x 41	4.95	5.69	0.0327	0.0295	EEGAA1D273CA□
39000	35 x 54	5.86	6.74	0.0269	0.0242	EEGAA1C393CC□	33000	35 x 54	5.72	6.58	0.0274	0.0246	EEGAA1D333CC□
56000	35 x 67	7.30	8.40	0.0196	0.0177	EEGAA1C563CE□	47000	35 x 67	7.12	8.19	0.0202	0.0181	EEGAA1D473CE□
68000	35 x 79	8.31	9.56	0.0167	0.0150	EEGAA1C683CG□	56000	35 x 79	8.05	9.26	0.0174	0.0157	EEGAA1D563CG□
82000	35 x 92	9.37	10.78	0.0143	0.0129	EEGAA1C823CH□	68000	35 x 92	9.12	10.49	0.0149	0.0134	EEGAA1D683CH□
100000	35 x 105	10.51	12.09	0.0123	0.0110	EEGAA1C104CK□	82000	35 x 105	10.21	11.74	0.0129	0.0116	EEGAA1D823CK□
120000	35 x 117	11.67	13.42	0.0107	0.0096	EEGAA1C124CL□	100000	35 x 117	11.45	13.17	0.0112	0.0100	EEGAA1D104CL□
130000	35 x 130	12.41	14.27	0.0101	0.0091	EEGAA1C134CN□	110000	35 x 130	12.25	14.09	0.0104	0.0094	EEGAA1D114CN□
150000	35 x 143	13.44	15.46	0.0091	0.0082	EEGAA1C154CP□	120000	35 x 143	13.04	15.00	0.0098	0.0088	EEGAA1D124CP□
82000	51 x 48	10.01	11.51	0.0143	0.0129	EEGAA1C823FB□	68000	51 x 48	9.75	11.21	0.0149	0.0134	EEGAA1D683FB□
100000	51 x 54	11.01	12.66	0.0123	0.0110	EEGAA1C104FC□	82000	51 x 54	10.70	12.31	0.0129	0.0116	EEGAA1D823FC□
120000	51 x 67	12.41	14.27	0.0107	0.0096	EEGAA1C124FE□	100000	51 x 67	12.17	14.00	0.0112	0.0100	EEGAA1D104FE□
150000	51 x 79	13.98	16.08	0.0091	0.0082	EEGAA1C154FG□	120000	51 x 79	13.57	15.61	0.0098	0.0088	EEGAA1D124FG□
180000	51 x 92	15.42	17.73	0.0081	0.0073	EEGAA1C184FH□	150000	51 x 92	15.22	17.50	0.0085	0.0077	EEGAA1D154FH□
220000	51 x 105	16.93	19.47	0.0072	0.0064	EEGAA1C224FK□	180000	51 x 105	16.68	19.18	0.0076	0.0069	EEGAA1D184FK□
270000	51 x 130	19.08	21.94	0.0052	0.0047	EEGAA1C274FN□	220000	51 x 130	18.86	21.69	0.0068	0.0061	EEGAA1D224FN□
330000	51 x 143	20.63	23.72	0.0070	0.0063	EEGAA1C334FP□	270000	51 x 143	20.50	23.58	0.0061	0.0055	EEGAA1D274FP□
270000	64 x 79	19.31	22.21	0.0064	0.0057	EEGAA1C274GG□	220000	64 x 79	19.08	21.94	0.0068	0.0061	EEGAA1D224GG□
330000	64 x 92	21.02	24.17	0.0057	0.0052	EEGAA1C334GH□	270000	64 x 92	20.89	24.02	0.0061	0.0055	EEGAA1D274GH□
390000	64 x 105	22.50	25.88	0.0053	0.0048	EEGAA1C394GK□	330000	64 x 105	22.62	26.01	0.0056	0.0050	EEGAA1D334GK□
470000	64 x 117	24.11	27.73	0.0049	0.0044	EEGAA1C474GL□	390000	64 x 117	24.21	27.84	0.0052	0.0047	EEGAA1D394GL□
500000	64 x 130	25.05	28.81	0.0048	0.0043	EEGAA1C504GN□	430000	64 x 130	25.38	29.19	0.0050	0.0045	EEGAA1D434GN□
560000	64 x 143	26.23	30.16	0.0046	0.0041	EEGAA1C564GP□	470000	64 x 143	26.49	30.46	0.0049	0.0044	EEGAA1D474GP□
390000	76 x 79	23.79	27.36	0.0053	0.0048	EEGAA1C394HG□	330000	76 x 79	23.92	27.51	0.0056	0.0050	EEGAA1D334HG□
470000	76 x 92	25.51	29.34	0.0049	0.0044	EEGAA1C474HH□	390000	76 x 92	25.62	29.46	0.0052	0.0047	EEGAA1D394HH□
560000	76 x 105	27.08	31.14	0.0046	0.0041	EEGAA1C564HK□	470000	76 x 105	27.34	31.44	0.0049	0.0044	EEGAA1D474HK□
680000	76 x 117	28.74	33.05	0.0043	0.0039	EEGAA1C684HL□	560000	76 x 117	29.03	33.38	0.0046	0.0041	EEGAA1D564HL□
750000	76 x 130	29.88	34.36	0.0042	0.0037	EEGAA1C754HN□	620000	76 x 130	30.25	34.79	0.0045	0.0040	EEGAA1D624HN□
820000	76 x 143	30.97	35.62	0.0040	0.0036	EEGAA1C824HP□	680000	76 x 143	31.41	36.12	0.0044	0.0039	EEGAA1D684HP□
1200000	76 x 219	36.78	42.30	0.0037	0.0033	EEGAA1C125HW□	1000000	76 x 219	37.54	43.17	0.0040	0.0036	EEGAA1D105HW□

G-BA Series screw terminal style

- Long life for industrial applications
- 2000 hour life @ 105°C with ripple current applied
- High CV design
- Customized designs available



Rated Working Voltage:	10 ~ 450 VDC
Operating Temperature:	-40 ~ +105°C
Nominal Capacitance:	220 ~ 1200000μF
Capacitance Tolerance:	± 20%
Endurance:	2000 hours at +105°C with maximum specified ripple current (see page 4)

Part Number System

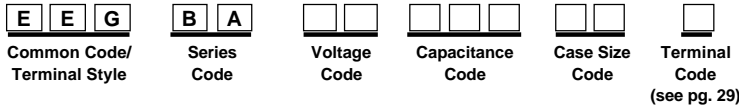

G-BA Typical Ratings

Cap. (μF)	Nominal Size D x L (mm)	Max 105°C R.C. (A _{rms})		20°C ESR (Ω, max.)		Panasonic Part Number	Cap. (μF)	Nominal Size D x L (mm)	Max 105°C R.C. (A _{rms})		20°C ESR (Ω, max.)		Panasonic Part Number
		120Hz	10k-50kHz	120Hz	20kHz				120Hz	10k-50kHz	120Hz	20kHz	
10 VDC Working, 13 VDC Surge							16 VDC Working, 20 VDC Surge						
33000	35 x 41	4.67	5.37	0.0402	0.0362	EEGBA1A333CA□	22000	35 x 41	4.47	5.14	0.0435	0.0392	EEGBA1C223CA□
39000	35 x 54	5.31	6.11	0.0345	0.0310	EEGBA1A393CC□	33000	35 x 54	5.65	6.50	0.0301	0.0271	EEGBA1C333CC□
56000	35 x 67	6.62	7.61	0.0249	0.0224	EEGBA1A563CE□	47000	35 x 67	6.99	8.04	0.0221	0.0199	EEGBA1C473CE□
75000	35 x 79	7.86	9.04	0.0194	0.0174	EEGBA1A753CG□	56000	35 x 79	7.89	9.07	0.0191	0.0172	EEGBA1C563CG□
82000	35 x 92	8.52	9.80	0.0180	0.0162	EEGBA1A823CH□	68000	35 x 92	8.91	10.25	0.0163	0.0146	EEGBA1C683CH□
100000	35 x 105	9.56	10.99	0.0153	0.0138	EEGBA1A104CK□	82000	35 x 105	9.93	11.42	0.0141	0.0126	EEGBA1C823CK□
120000	35 x 117	10.64	12.24	0.0132	0.0119	EEGBA1A124CL□	91000	35 x 117	10.71	12.32	0.0130	0.0117	EEGBA1C913CL□
130000	35 x 130	11.32	13.02	0.0125	0.0112	EEGBA1A134CN□	100000	35 x 130	11.44	13.16	0.0121	0.0109	EEGBA1C104CN□
150000	35 x 143	12.28	14.12	0.0112	0.0101	EEGBA1A154CP□	120000	35 x 143	12.55	14.43	0.0106	0.0096	EEGBA1C124CP□
82000	51 x 48	9.10	10.47	0.0180	0.0162	EEGBA1A823FB□	56000	51 x 48	8.81	10.13	0.0191	0.0172	EEGBA1C563FB□
100000	51 x 54	10.03	11.53	0.0153	0.0138	EEGBA1A104FC□	75000	51 x 54	10.07	11.58	0.0151	0.0136	EEGBA1C753FC□
120000	51 x 67	11.32	13.02	0.0132	0.0119	EEGBA1A124FE□	100000	51 x 67	11.78	13.55	0.0121	0.0109	EEGBA1C104FE□
150000	51 x 79	12.77	14.69	0.0112	0.0101	EEGBA1A154FG□	120000	51 x 79	13.06	15.02	0.0106	0.0096	EEGBA1C124FG□
180000	51 x 92	14.11	16.23	0.0098	0.0089	EEGBA1A184FH□	150000	51 x 92	14.56	16.74	0.0092	0.0082	EEGBA1C154FH□
220000	51 x 105	15.53	17.86	0.0086	0.0077	EEGBA1A224FK□	180000	51 x 105	15.87	18.25	0.0082	0.0073	EEGBA1C184FK□
270000	51 x 130	17.54	20.17	0.0076	0.0068	EEGBA1A274FN□	220000	51 x 130	17.83	20.50	0.0073	0.0065	EEGBA1C224FN□
330000	51 x 143	19.00	21.85	0.0067	0.0061	EEGBA1A334FP□	270000	51 x 143	19.26	22.15	0.0065	0.0059	EEGBA1C274FP□
270000	64 x 79	17.74	20.40	0.0076	0.0068	EEGBA1A274GG□	180000	64 x 79	17.09	19.65	0.0082	0.0073	EEGBA1C184GG□
330000	64 x 92	19.36	22.26	0.0067	0.0061	EEGBA1A334GH□	220000	64 x 92	18.67	21.47	0.0073	0.0065	EEGBA1C224GH□
390000	64 x 105	20.76	23.87	0.0062	0.0056	EEGBA1A394GK□	270000	64 x 105	20.21	23.24	0.0065	0.0059	EEGBA1C274GK□
470000	64 x 117	22.29	25.63	0.0056	0.0051	EEGBA1A474GL□	330000	64 x 117	21.76	25.02	0.0059	0.0053	EEGBA1C334GL□
510000	64 x 130	23.27	26.76	0.0054	0.0049	EEGBA1A514GN□	390000	64 x 130	23.08	26.54	0.0055	0.0050	EEGBA1C394GN□
560000	64 x 143	24.29	27.93	0.0052	0.0047	EEGBA1A564GP□	470000	64 x 143	24.46	28.13	0.0051	0.0046	EEGBA1C474GP□
390000	76 x 79	21.95	25.24	0.0062	0.0056	EEGBA1A394HG□	330000	76 x 79	22.32	25.67	0.0059	0.0053	EEGBA1C334HG□
470000	76 x 92	23.58	27.12	0.0056	0.0051	EEGBA1A474HH□	390000	76 x 92	23.79	27.36	0.0055	0.0050	EEGBA1C394HH□
560000	76 x 105	25.08	28.84	0.0052	0.0047	EEGBA1A564HK□	470000	76 x 105	25.25	29.04	0.0051	0.0046	EEGBA1C474HK□
680000	76 x 117	26.68	30.68	0.0048	0.0044	EEGBA1A684HL□	510000	76 x 117	26.29	30.23	0.0050	0.0045	EEGBA1C514HL□
750000	76 x 130	27.76	31.92	0.0047	0.0042	EEGBA1A754HN□	560000	76 x 130	27.32	31.42	0.0048	0.0043	EEGBA1C564HN□
820000	76 x 143	28.79	33.11	0.0045	0.0041	EEGBA1A824HP□	620000	76 x 143	28.36	32.61	0.0047	0.0042	EEGBA1C624HP□
1200000	76 x 219	34.30	39.45	0.0041	0.0036	EEGBA1A125HW□	1000000	76 x 219	34.01	39.11	0.0041	0.0037	EEGBA1C105HW□

