



SC70 Inverting Charge Pumps with Shutdown

MAX1852/MAX1853

General Description

The MAX1852/MAX1853 monolithic, CMOS charge-pump voltage inverters in the ultra-small SC70 package feature a low 15Ω output resistance, permitting loads up to 30mA with maximum efficiency. The MAX1852/MAX1853 are available with operating frequencies of 50kHz and 200kHz, respectively, allowing optimization of supply current or external component size. Small external components and micropower shutdown mode make these devices ideal for both battery-powered and board-level voltage conversion applications.

Oscillator control circuitry and four power-MOSFET switches are included on-chip. Applications include generating a negative supply from a +5V or +3.3V logic supply to power analog circuitry. Both versions come in a 6-pin SC70 package that is 40% smaller than a SOT23.

Applications

- Negative Supply from +5V or +3.3V Logic Supplies
- Small LCD Panels
- GaAsFET Bias Supplies
- Handy-Terminals, PDAs
- Battery-Operated Equipment

Features

- ◆ 30mA Output Current
- ◆ Low 15Ω Output Resistance
- ◆ 68μA Supply Current (MAX1852)
- ◆ Requires Only Two 0.68μF Capacitors (MAX1853)
- ◆ +2.5V to +5.5V Input Voltage Range
- ◆ 0.1μA Logic-Controlled Shutdown
- ◆ Two Switching Frequencies
50kHz (MAX1852)
200kHz (MAX1853)
- ◆ Slew-Rate Limited to Reduce EMI
- ◆ Ultra-Small 6-Pin SC70 Package

Ordering Information

PART	TEMP. RANGE	PIN-PACKAGE	TOP MARK
MAX1852EXT	-40°C to +85°C	6 SC70	AAL
MAX1853EXT	-40°C to +85°C	6 SC70	AAM

Typical Operating Circuit

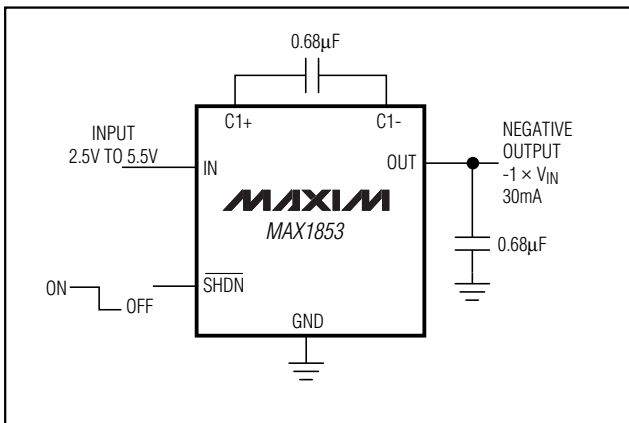

Pin Configuration

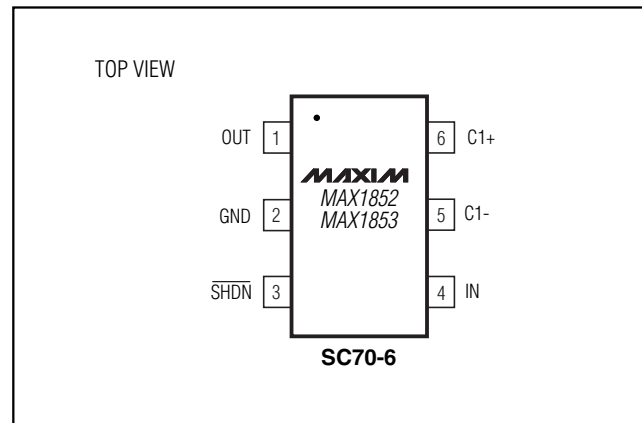

SC70 Inverting Charge Pumps with Shutdown

ABSOLUTE MAXIMUM RATINGS

IN to GND	-0.3V to +6V	Continuous Power Dissipation ($T_A = +70^\circ\text{C}$)	
C1+, $\overline{\text{SHDN}}$ to GND	-0.3V to ($V_{\text{IN}} + 0.3\text{V}$)	6-Pin SC70 (derate 3.1mW/ $^\circ\text{C}$ above $+70^\circ\text{C}$)	245mW
C1- to GND	($V_{\text{OUT}} - 0.3\text{V}$) to +0.3V	Operating Temperature Range	-40 $^\circ\text{C}$ to +85 $^\circ\text{C}$
OUT to GND	+0.3V to -6V	Junction Temperature	+150 $^\circ\text{C}$
OUT Short-Circuit to GND	1 minute	Storage Temperature Range	-65 $^\circ\text{C}$ to +150 $^\circ\text{C}$

Stresses beyond those listed under "Absolute Maximum Ratings" may cause permanent damage to the device. These are stress ratings only, and functional operation of the device at these or any other conditions beyond those indicated in the operational sections of the specifications is not implied. Exposure to absolute maximum rating conditions for extended periods may affect device reliability.

ELECTRICAL CHARACTERISTICS

(Circuit of Figure 1, capacitors from Table 2, $V_{\text{IN}} = +5\text{V}$, $\overline{\text{SHDN}} = \text{IN}$, $T_A = -40^\circ\text{C}$ to $+85^\circ\text{C}$, unless otherwise noted. Typical values are at $T_A = +25^\circ\text{C}$.) (Note 1)

PARAMETER	CONDITIONS		MIN	TYP	MAX	UNITS
Supply Voltage Range			2.5		5.5	V
Quiescent Supply Current	MAX1852	$T_A = +25^\circ\text{C}$		75	130	μA
		$T_A = -40^\circ\text{C}$ to $+85^\circ\text{C}$			150	
	MAX1853	$T_A = +25^\circ\text{C}$		165	320	
		$T_A = -40^\circ\text{C}$ to $+85^\circ\text{C}$			350	
Shutdown Supply Current	$\overline{\text{SHDN}} = \text{GND}$	$T_A = +25^\circ\text{C}$		0.002	0.5	μA
		$T_A = +85^\circ\text{C}$		0.01		
Oscillator Frequency	MAX1852	$T_A = +25^\circ\text{C}$	32	50	68	kHz
		$T_A = -40^\circ\text{C}$ to $+85^\circ\text{C}$	25		78	
	MAX1853	$T_A = +25^\circ\text{C}$	130	200	270	
		$T_A = -40^\circ\text{C}$ to $+85^\circ\text{C}$	110		310	
Voltage Conversion Efficiency	$I_{\text{OUT}} = 0$		99	99.9		%
Output Resistance (Note 2)	$I_{\text{OUT}} = 10\text{mA}$	$T_A = +25^\circ\text{C}$		15	30	Ω
		$T_A = -40^\circ\text{C}$ to $+85^\circ\text{C}$			40	
Output Current	Continuous, long-term				30	mARMS
$\overline{\text{SHDN}}$ Input Logic High	$+2.5\text{V} \leq V_{\text{IN}} \leq +5.5\text{V}$		$0.7 \times V_{\text{IN}}$			V
$\overline{\text{SHDN}}$ Input Logic Low	$+2.5\text{V} \leq V_{\text{IN}} \leq +5.5\text{V}$				$0.3 \times V_{\text{IN}}$	V
$\overline{\text{SHDN}}$ Bias Current	$\overline{\text{SHDN}} = \text{GND}$ or IN	$T_A = +25^\circ\text{C}$	-100	1	100	nA
		$T_A = +85^\circ\text{C}$		10		
Wake-Up Time From Shutdown	$I_{\text{OUT}} = 5\text{mA}$	MAX1852		260		μs
		MAX1853		112		

Note 1: All devices are 100% production tested at $T_A = +25^\circ\text{C}$. All temperature limits are guaranteed by design.

Note 2: Output resistance is guaranteed with capacitor ESR of 0.3Ω or less.

SC70 Inverting Charge Pumps with Shutdown

Typical Operating Characteristics

(Circuit of Figure 1, capacitors from Table 2, $V_{IN} = +5V$, $\overline{SHDN} = IN$, $T_A = +25^\circ C$, unless otherwise noted.)

MAX1852/MAX1853

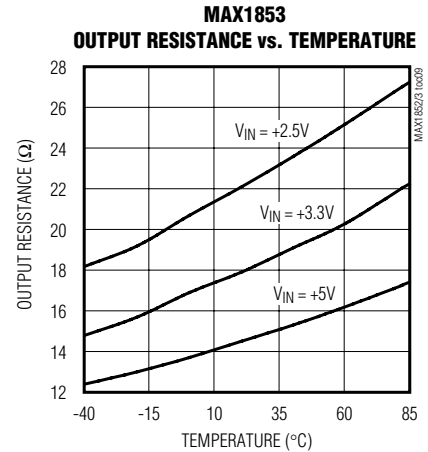
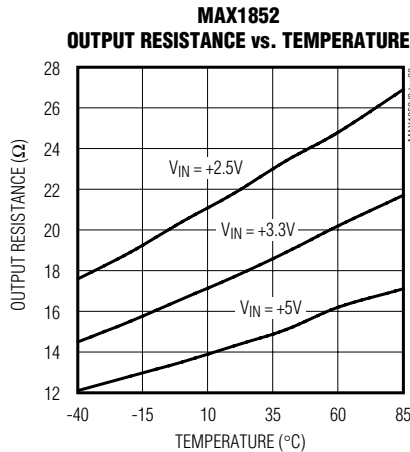
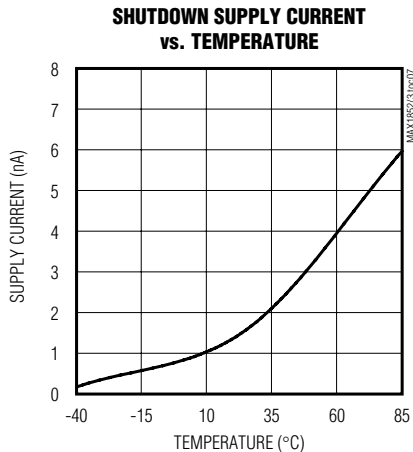
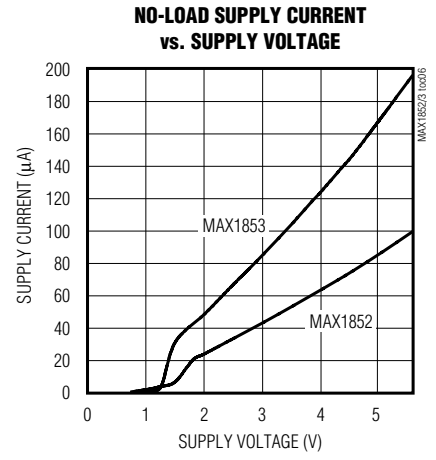
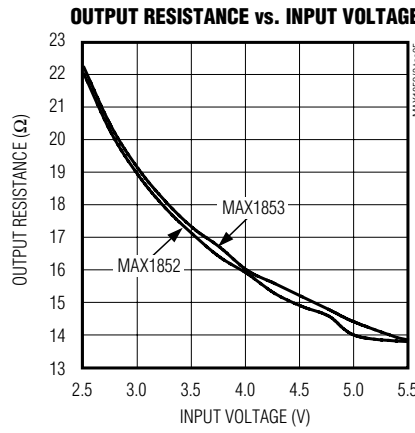
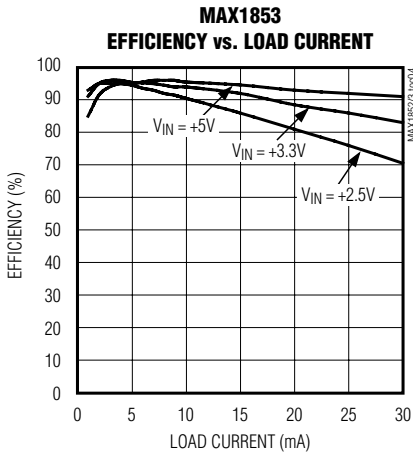
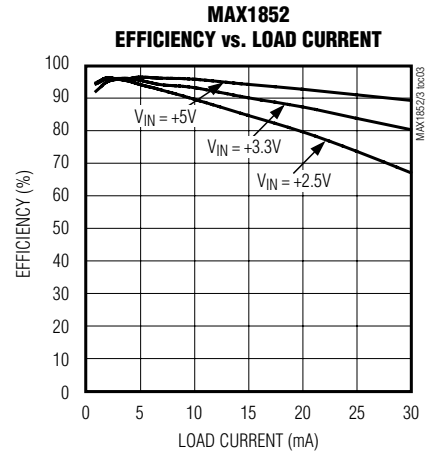
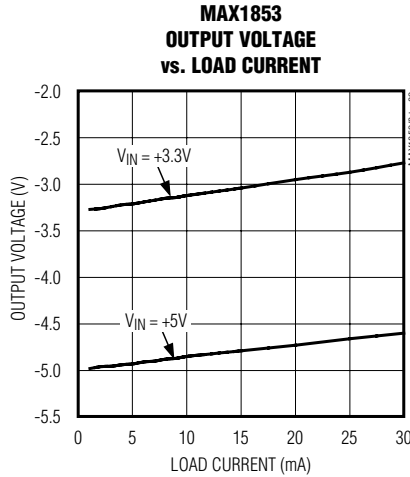
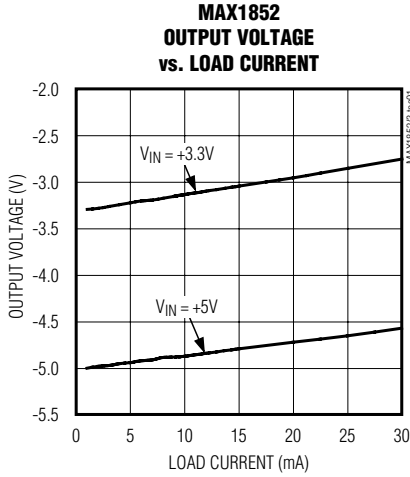

SC70 Inverting Charge Pumps with Shutdown

Typical Operating Characteristics (continued)

(Circuit of Figure 1, capacitors from Table 2, $V_{IN} = +5V$, $\overline{SHDN} = IN$, $T_A = +25^\circ C$, unless otherwise noted.)

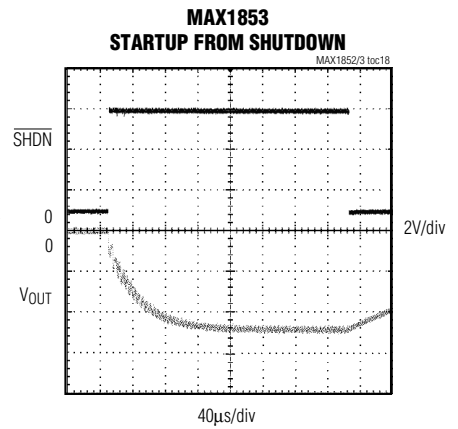
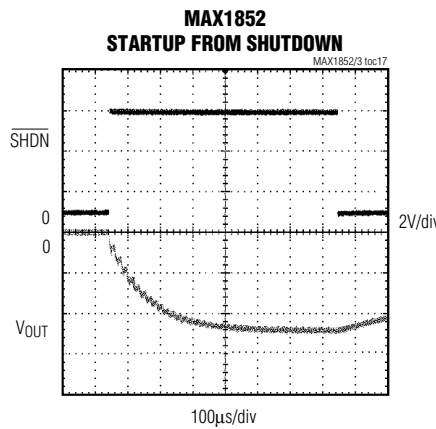
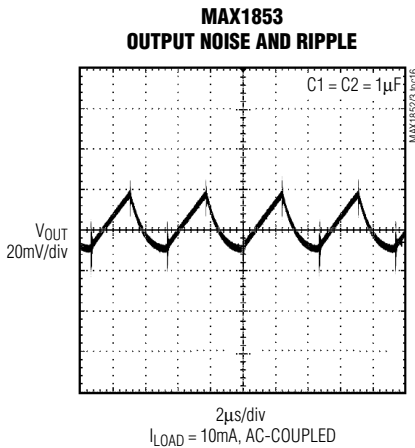
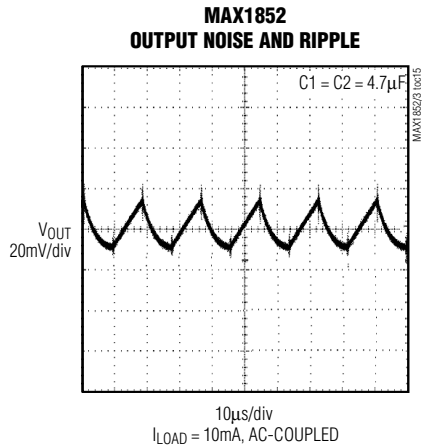
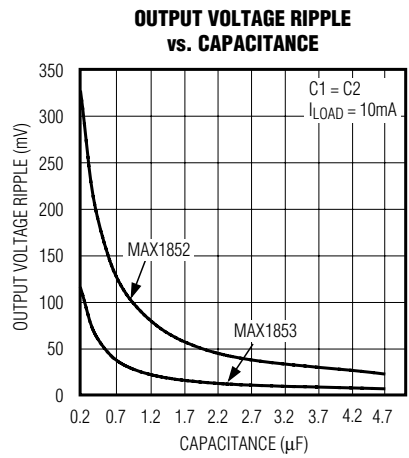
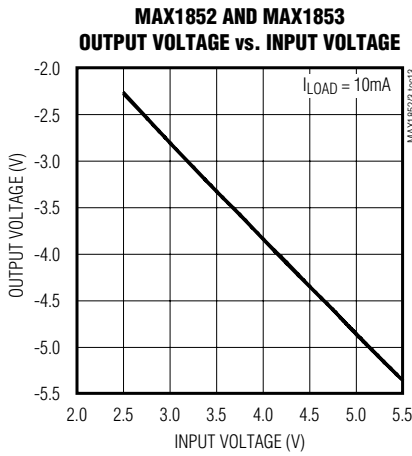
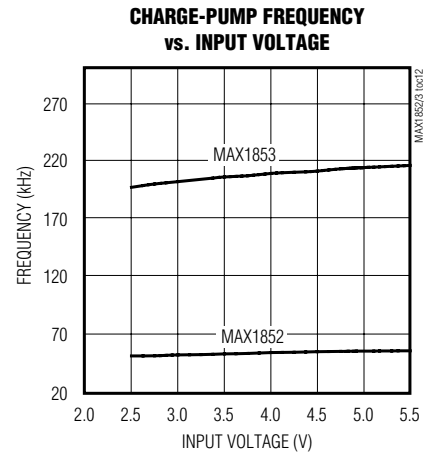
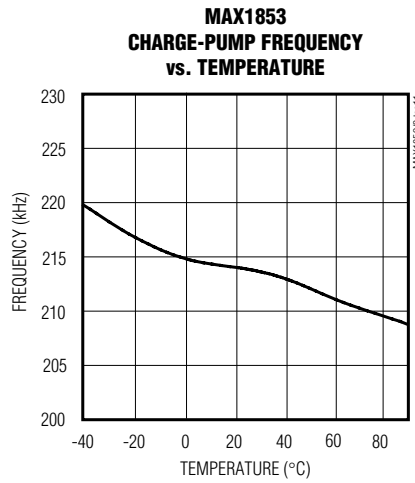
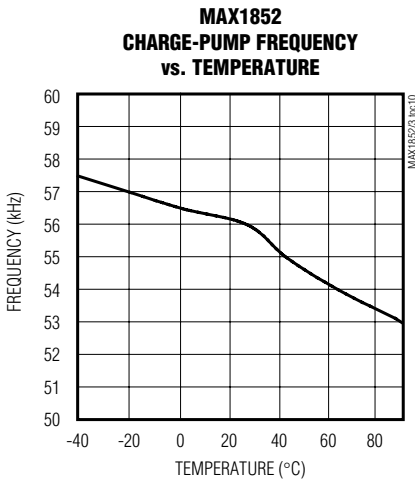

SC70 Inverting Charge Pumps with Shutdown

Pin Description

PIN	NAME	FUNCTION
1	OUT	Inverting Charge-Pump Output
2	GND	Ground
3	$\overline{\text{SHDN}}$	Shutdown Input. Drive this pin high for normal operation; drive it low for shutdown mode.
4	IN	Power-Supply Voltage Input. Input range is +2.5V to +5.5V.
5	C1-	Negative Terminal of the Flying Capacitor
6	C1+	Positive Terminal of the Flying Capacitor

Detailed Description

The MAX1852/MAX1853 charge pumps invert the voltage applied to their input. For highest performance use low equivalent series resistance (ESR) capacitors (e.g., ceramic).

During the first half-cycle, switches S2 and S4 open, switches S1 and S3 close, and capacitor C1 charges to the voltage at IN (Figure 2). During the second half-cycle, S1 and S3 open, S2 and S4 close, and C1 is level shifted downward by V_{IN} volts. This connects C1 in parallel with the reservoir capacitor C2. If the voltage across C2 is smaller than the voltage across C1, charge flows from C1 to C2 until the voltage across C2 reaches $-V_{IN}$. The actual voltage at the output is more positive than $-V_{IN}$ since switches S1–S4 have resistance and the load drains charge from C2.

Efficiency Considerations

The efficiency of the MAX1852/MAX1853 is dominated by their quiescent supply current (I_Q) at low output current and by their output impedance (R_{OUT}) at higher output current; it is given by:

$$\eta \cong \frac{I_{OUT}}{I_{OUT} + I_Q} \left(1 - \frac{I_{OUT} \times R_{OUT}}{V_{IN}} \right)$$

where the output impedance is roughly approximated by:

$$R_{OUT} \cong \frac{1}{(f_{OSC}) \times C1} + 2R_{SW} + 4ESR_{C1} + ESR_{C2}$$

The first term is the effective resistance of an ideal switched-capacitor circuit (Figures 3a and 3b), and R_{SW} is the sum of the charge pump's internal switch

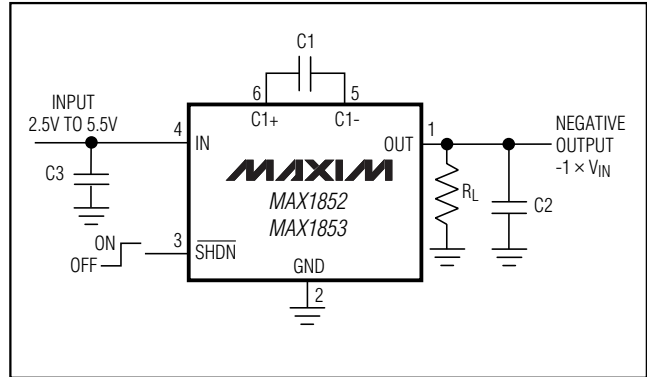

Figure 1. Typical Application Circuit

resistances (typically 6Ω at $V_{IN} = +5V$). The typical output impedance is more accurately determined from the *Typical Operating Characteristics*.

Shutdown

The MAX1852/MAX1853 have a logic-controlled shutdown input. Driving $\overline{\text{SHDN}}$ low places the devices in a low-power shutdown mode. The charge-pump switching halts, supply current is reduced to 2nA.

Driving $\overline{\text{SHDN}}$ high will restart the charge pump. The switching frequency and capacitor values determine how soon the device will reach 90% of the input voltage.

Applications Information

Capacitor Selection

The charge-pump output resistance is a function of the ESR of C1 and C2. To maintain the lowest output resistance, use capacitors with low ESR. (See Table 1 for a list of recommended manufacturers.) Tables 2 and 3 suggest capacitor values for minimizing output resistance or capacitor size.

Flying Capacitor (C1)

Increasing the flying capacitor's value reduces the output resistance. Above a certain point, increasing C1's capacitance has negligible effect because the output resistance is then dominated by internal switch resistance and capacitor ESR.

Output Capacitor (C2)

Increasing the output capacitor's value reduces the output ripple voltage. Decreasing its ESR reduces both output resistance and ripple. Lower capacitance values can be used with light loads if higher output ripple can be tolerated. Use the following equation to calculate the peak-to-peak ripple:

SC70 Inverting Charge Pumps with Shutdown

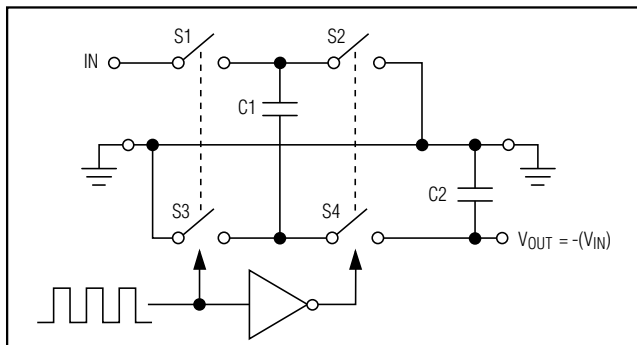

Figure 2. Ideal Voltage Inverter

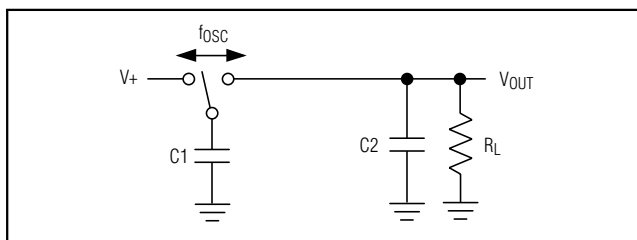

Figure 3a. Switched-Capacitor Model

$$V_{\text{RIPPLE}} = \frac{I_{\text{OUT}}}{2(f_{\text{OSC}})C_2} + 2 \times I_{\text{OUT}} \times \text{ESR}_{C_2}$$

Input Bypass Capacitor (C3)

If necessary, bypass the incoming supply to reduce its AC impedance and the impact of the MAX1852/MAX1853s' switching noise. A bypass capacitor with a value equal to that of C1 is recommended.

Voltage Inverter

The most common application for these devices is a charge-pump voltage inverter (Figure 1). This application requires only two external components—capacitors C1 and C2—plus a bypass capacitor, if necessary. Refer to the *Capacitor Selection* section for suggested capacitor types.

Cascading Devices

Two devices can be cascaded to produce an even larger negative voltage (Figure 4). The unloaded output voltage is normally $-2 \times V_{\text{IN}}$, but this is reduced slightly by the output resistance of the first device multiplied by the quiescent current of the second. When cascading more than two devices, the output resistance rises significantly. For applications requiring larger negative voltages, see the MAX865 and MAX868 data sheets.

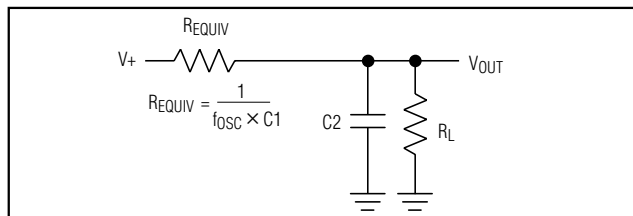

Figure 3b. Equivalent Circuit

Paralleling Devices

Paralleling multiple MAX1852/MAX1853s reduces the output resistance. Each device requires its own pump capacitor (C1), but the reservoir capacitor (C2) serves all devices (Figure 5). Increase C2's value by a factor of n , where n is the number of parallel devices. Figure 5 shows the equation for calculating output resistance.

Combined Doubler/Inverter

In the circuit of Figure 6, capacitors C1 and C2 form the inverter, while C3 and C4 form the doubler. C1 and C3 are the pump capacitors; C2 and C4 are the reservoir capacitors. Because both the inverter and doubler use part of the charge-pump circuit, loading either output causes both outputs to decline toward GND. Make sure the sum of the currents drawn from the two outputs does not exceed 30mA.

Heavy Load Connected to a Positive Supply

Under heavy loads, where a higher supply is sourcing current into OUT, the OUT supply must not be pulled above ground. Applications that sink heavy current into OUT require a Schottky diode (1N5817) between GND and OUT, with the anode connected to OUT (Figure 7).

Layout and Grounding

Good layout is important, primarily for good noise performance. To ensure good layout, mount all components as close together as possible, keep traces short to minimize parasitic inductance and capacitance, and use a ground plane.

SC70 Inverting Charge Pumps with Shutdown

MAX1852/MAX1853

Table 1. Low-ESR Capacitor Manufacturers

PRODUCTION METHOD	MANUFACTURER	SERIES	PHONE	FAX
Surface-Mount Tantalum	AVX	TPS series	803-946-0690	803-626-3123
	Matsuo	267 series	714-969-2491	714-960-6492
	Sprague	593D, 595D series	603-224-1961	603-224-1430
Surface-Mount Ceramic	AVX	X7R	803-946-0690	803-626-3123
	Matsuo	X7R	714-969-2491	714-960-6492

Table 2. Capacitor Selection to Minimize Output Resistance

PART	FREQUENCY (kHz)	CAPACITOR (μF)	TYPICAL R_{OUT} (Ω)
MAX1852	50	4.7	15
MAX1853	200	1	15

Table 3. Capacitor Selection to Minimize Capacitor Size

PART	FREQUENCY (kHz)	CAPACITOR (μF)	TYPICAL R_{OUT} (Ω)
MAX1852	50	3.3	20
MAX1853	200	0.68	20

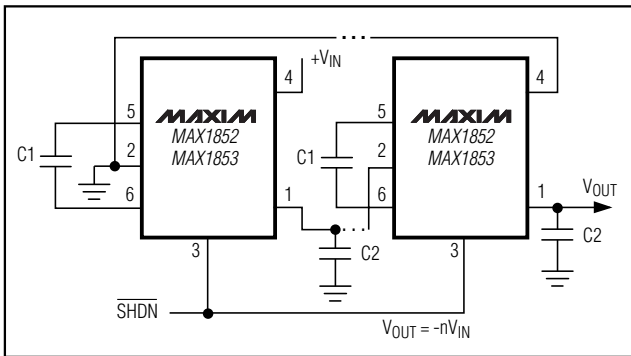

Figure 4. Cascading MAX1852/MAX1853s to Increase Output Voltage

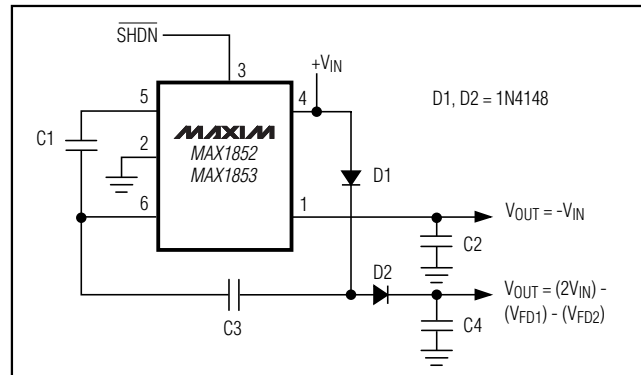

Figure 6. Combined Doubler and Inverter

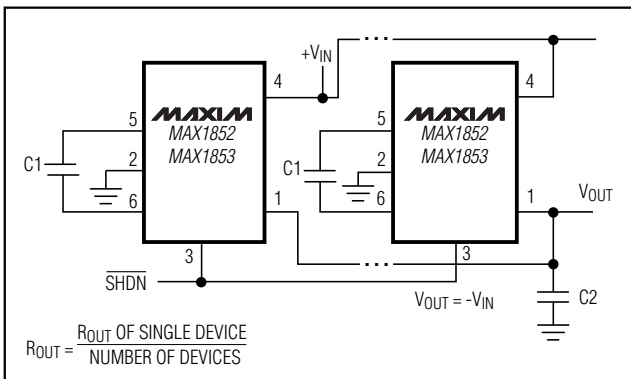

Figure 5. Paralleling MAX1852/MAX1853s to Reduce Output Resistance

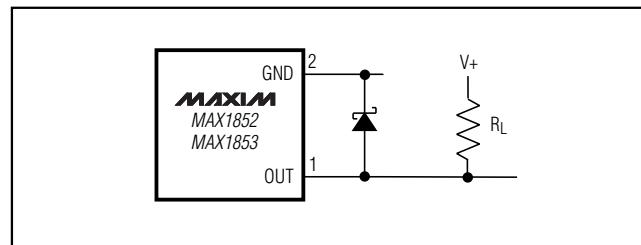

Figure 7. Heavy Load Connected to a Positive Supply

Chip Information

TRANSISTOR COUNT: 252

SC70 Inverting Charge Pumps with Shutdown

Package Information

SC70, 6L, EPS

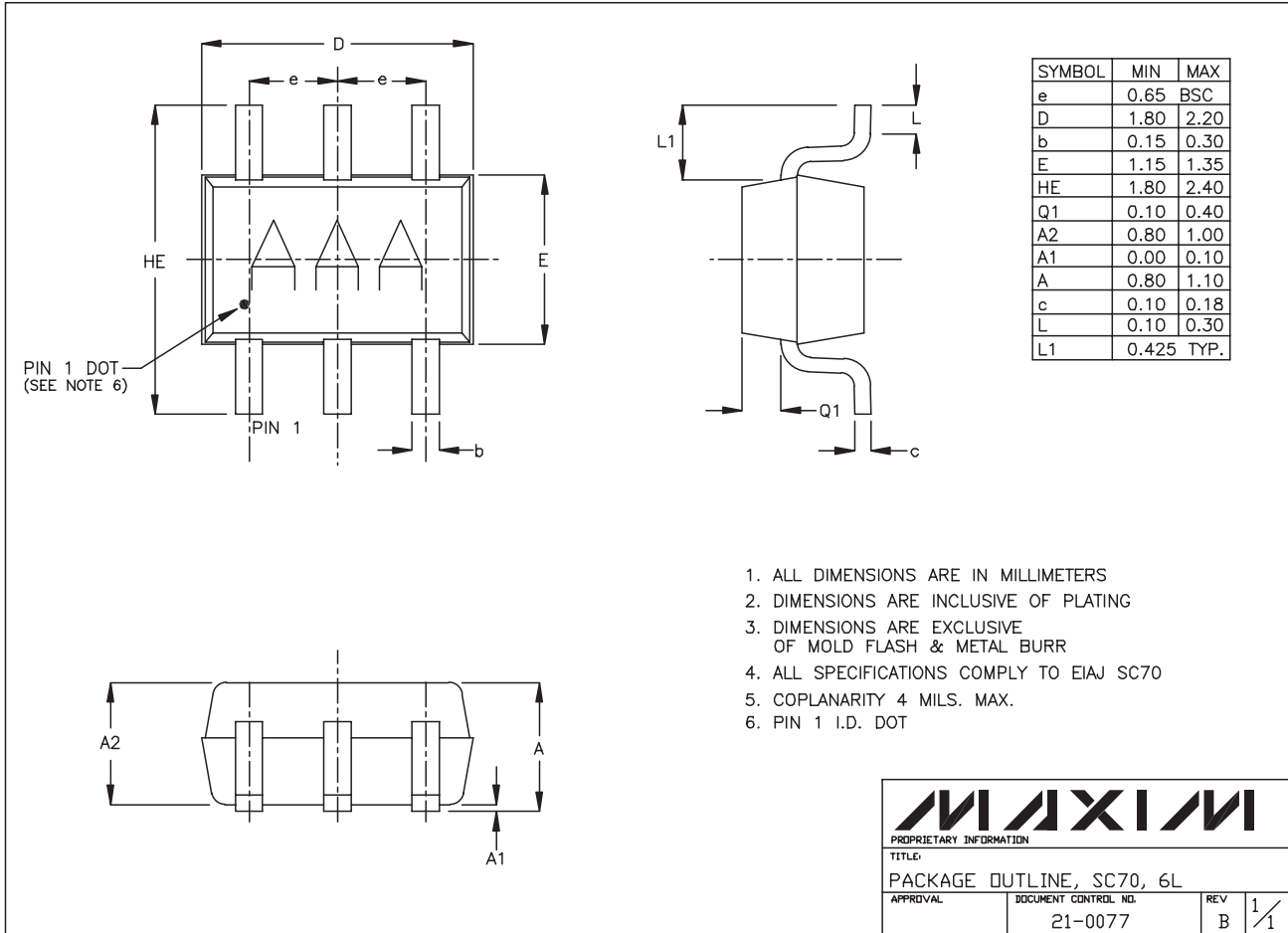

1. ALL DIMENSIONS ARE IN MILLIMETERS
2. DIMENSIONS ARE INCLUSIVE OF PLATING
3. DIMENSIONS ARE EXCLUSIVE OF MOLD FLASH & METAL BURR
4. ALL SPECIFICATIONS COMPLY TO EIAJ SC70
5. COPLANARITY 4 MILS. MAX.
6. PIN 1 I.D. DOT

MAXIM
PROPRIETARY INFORMATION
 TITLE:
 PACKAGE OUTLINE, SC70, 6L
 APPROVAL: _____ DOCUMENT CONTROL NO. 21-0077 REV B 1/1

Maxim cannot assume responsibility for use of any circuitry other than circuitry entirely embodied in a Maxim product. No circuit patent licenses are implied. Maxim reserves the right to change the circuitry and specifications without notice at any time.

8 Maxim Integrated Products, 120 San Gabriel Drive, Sunnyvale, CA 94086 (408) 737-7600