

## 3–7 W DC/DC Power Modules 48 V Input Series

- SMD and through-hole versions with ultra low component height 8.0 mm (0.315 in)
- 83% efficiency (typ at 5V)
- 1,500 Vdc isolation voltage
- MTBF > 4.9 million hours at +50°C pin temperature (+40°C ambient)
- Low EMI in conformance with class A in CISPR 22 and FCC part 15J



Patents

US: D357901 DE: M94022763

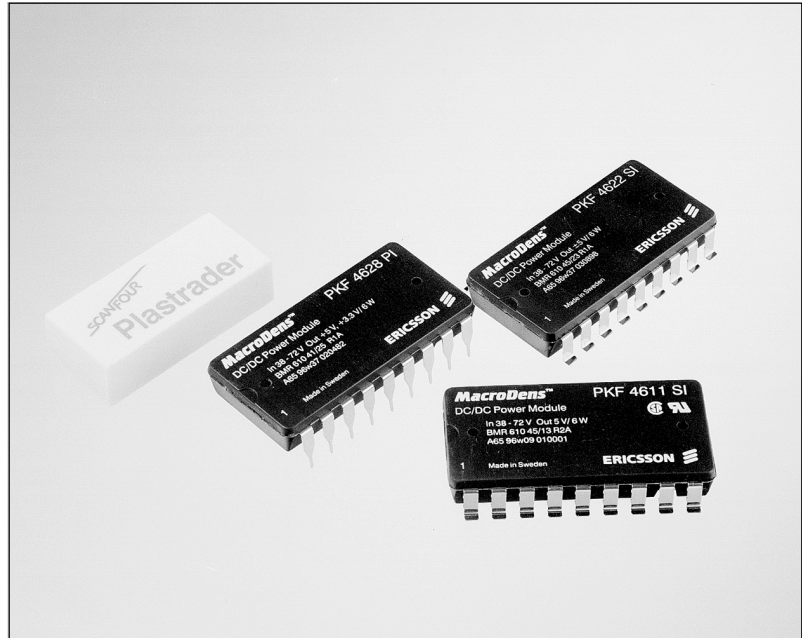

The MacroDens™ 3–7 W PKF 4000 I series true component level on-board DC/DC power modules are intended as distributed power sources in decentralized –48 V and –60 V DC power systems. Utilization of thick film technology and a high degree of silicon integration has made it possible to achieve a MTBF of more than 4.9 million hours.

The high reliability and the very low height of these DC/DC power modules makes them particularly suited for Information Technology and Telecom (IT&T) applications, with board spacing down to 15 mm or 0.6 in. The over-moulded rugged design makes them also suitable for other demanding industrial applications. They are optimized for free

convection cooling and have an operational ambient temperature range in compliance with present and future application needs, including non temperature controlled environments. The mechanical design offers the choice of surface mount or through-hole versions, delivered in ready-to-use tubes, trays or tape & reel package and compatibility with semi and fully aqueous cleaning processes.

The PKF series is manufactured using highly automated manufacturing lines with a world-class quality commitment and a five-year warranty.

Ericsson Microelectronics AB has been an ISO 9001 certified supplier since 1991. *For a complete product program please reference the back cover.*

# General

## Absolute Maximum Ratings

Characteristics		min	max	Unit
T <sub>P</sub>	Pin temperature at full output power <sup>1)</sup>	-45	+95	°C
T <sub>S</sub>	Storage temperature	-55	+125	°C
V <sub>I</sub>	Continuous input voltage <sup>2)</sup>	-0.5	+75	Vdc
V <sub>ISO</sub>	Isolation voltage (input to output test voltage)	1,500		Vdc
W <sub>tr</sub>	Transient input energy <sup>3)</sup>		0.1	Ws
V <sub>RC</sub>	Remote control voltage pin 10, 11	-5	+40	Vdc
V <sub>adj</sub>	Output adjust voltage pin 8, 9	-5	+40	Vdc

Stress in excess of Absolute Maximum Ratings may cause permanent damage. Absolute Maximum Ratings, sometimes referred to as no destruction limits, are normally tested with one parameter at a time exceeding the limits of Output data or Electrical Characteristics. If exposed to stress above these limits, function and performance may degrade in an unspecified manner.

## Input T<sub>P</sub> < T<sub>Pmax</sub> unless otherwise specified

Characteristics		Conditions	min	typ	max	Unit
V <sub>I</sub>	Input voltage range <sup>2) 4)</sup>		38	72		V
V <sub>off</sub>	Turn-off input voltage	(See typical characteristics)	30	34.5	36	V
V <sub>on</sub>	Turn-on input voltage	(See typical characteristics)		36.5	38	V
C <sub>I</sub>	Input capacitance			1.4		µF
P <sub>ii</sub>	Input idling power	I <sub>O</sub> =0, T <sub>P</sub> =-30...+85°C	(V <sub>I</sub> =53V) (V <sub>I</sub> =67V)		130 170	mW
P <sub>RC</sub>	Input stand-by power	T <sub>P</sub> =-30...+85°C, RC connected to pin 17	(V <sub>I</sub> =53V) (V <sub>I</sub> =67V)	25 30		mW

### NOTES:

- T<sub>P</sub> is defined as the maximum temperature on the connection pins at the PB (Printed Board) solder joint, mounted on a 5–8 dm<sup>2</sup> (1 dm<sup>2</sup>=15.5 in<sup>2</sup>) multi-layer PB (>4 layers), with 20 mm (0.8 in) board-pitch and free convection cooling. Corresponding ambient temperature range (T<sub>A</sub>) at full output power is -45...+85°C.
- The input voltage range 38...72 Vdc meets the European Telecom Standard prETS 300 132-2 Nominal input voltage range in 48V and 60 Vdc power systems, -40.5...-57.0V and -50.0...-72.0V respectively. At input voltages exceeding 72V (abnormal voltage) the power loss will be higher than at normal input voltage and T<sub>P</sub> must be limited to max +85°C. Absolute max continuous input voltage is 75 Vdc. Output characteristics will be marginally affected at input voltages exceeding 72 V.
- For more information see page 5.
- The power modules will operate down to V<sub>I</sub>≤36 V, when V<sub>I</sub> decreases, but will turn on at V<sub>I</sub>≤38 V, when V<sub>I</sub> increases (see also Operating information).
- The test is applicable for through-hole versions.

## Environmental Characteristics

Characteristics	Test procedure & conditions		
Vibration (Sinusoidal)	JESD 22-B103 (IEC 68-2-6 F <sub>d</sub> )	Frequency Amplitude Acceleration Number of cycles	10...500 Hz 0.75 mm 10 g 10 in each axis
Random vibration	MIL-STD-883 Method 2026 (IEC 68-2-34 E <sub>d</sub> )	Frequency Acceleration density spectrum Duration Reproducibility	10...500 Hz 0.5 g <sup>2</sup> /Hz 10 min in 3 directions medium (IEC 62-2-36)
Shock (Half sinus)	JESD 22-B104 (IEC 68-2-27 E <sub>d</sub> )	Peak acceleration Shock duration	200 g 3 ms
Temperature change	JESD 22-A104 (IEC 68-2-14 N <sub>a</sub> )	Temperature Number of cycles	-40°C...+125°C 500
Accelerated damp heat	JESD 22-A101 (IEC 68-2-3 C <sub>a</sub> with bias)	Temperature Humidity Duration	85°C 85% RH 1000 hours
Solder resistability <sup>5)</sup>	JESD 22-B106 (IEC 68-2-20 T <sub>b</sub> 1A)	Temperature, solder Duration	260°C 10...13 s
Aggressive environment	IEC 68-2-11 K <sub>a</sub>	Duration Temperature Concentration	96 h 35°C 5 %

## Mechanical Data

### Through-hole version

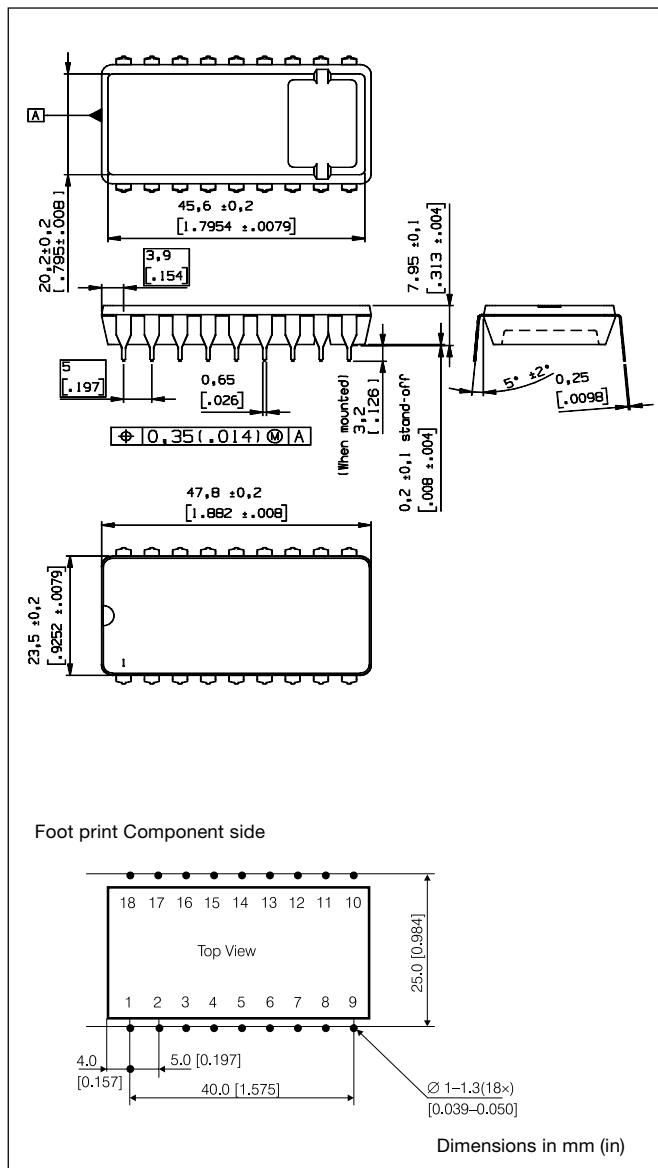

### Surface-mount version

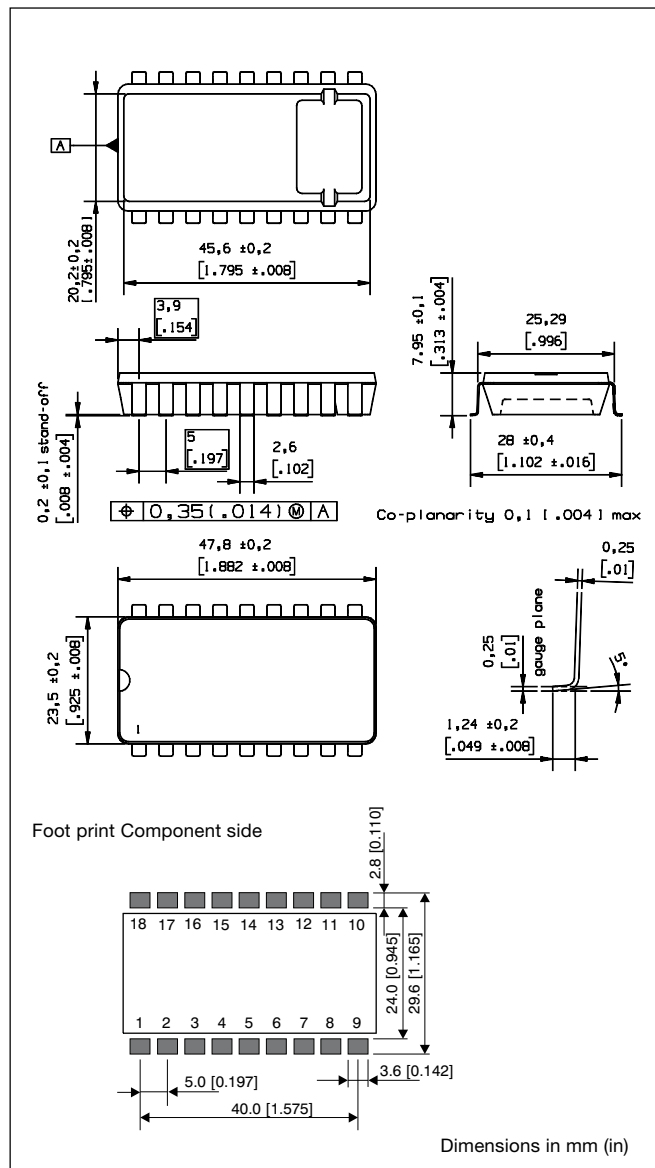

## Connections

Pin	Designation	Function
1	Out 1	Output 1. Positive voltage ref. to Rtn.
2	Rtn	Output return.
3	Out 2	Output 2 (+ or -). Not connected in single output models. Galvanically isolated from input pins.
4-6	NC	Not connected.
7	Aux	Not connected.
8	V <sub>adj</sub>	Output voltage adjust. To set typical output voltage (V <sub>O</sub> ) connect pin 8 to pin 9.
9	NOR	Connection of Nominal Output voltage Resistor. (See Operating Information, Output Voltage Adjust).
10	TOA	Turn-on/off input voltage adjust (V <sub>ION</sub> /V <sub>OFF</sub> ). Used to decrease the turn-on/off input voltage threshold. (See Operating Information).
11	RC	Remote control and turn-on/off input voltage adjust. Used to turn-on and turn-off output and to set the turn-on/off input voltage threshold.
12-16	NC	Not connected.
17	-In	Negative input.
18	+In	Positive input.

## Weight

Maximum 20 g (0.71 oz).

## Case

The case consists of semiconductor grade epoxy with embedded pins.

Coefficient of thermal expansion (CTE) is typ. 15 ppm/°C.

## Connection Pins

Base material is copper (Cu), first plating is nickel (Ni) and second (outer) plating is palladium (Pd).

# Thermal Data

## Two-parameter model

This model provides a more precise description of the thermal characteristics to be used for thermal calculations.

Thermally the power module can be considered as a component and the case temperature can be used to characterize the properties. The thermal data for a power module with the substrate in contact with the case can be described with two thermal resistances. One from case to ambient air and one from case to PB (Printed circuit Board).

The thermal characteristics temperature can be calculated from the following formula:

$$T_{PB} = (T_C - T_A) \times (R_{th\ C-PB} + R_{th\ C-A}) / R_{th\ C-A} - P_{diss} \times R_{th\ C-PB} + T_A$$

Where:

- $P_{diss}$ : dissipated power, calculated as  $P_O \times (1/\eta - 1)$
- $T_C$ : max average case temperature
- $T_A$ : ambient air temperature at the lower side of the power module
- $T_{PB}$ : temperature in the PB between the PKF connection pins
- $R_{th\ C-PB}$ : thermal resistance from case to PB under the power module
- $R_{th\ C-A}$ : thermal resistance from case to ambient air
- $v$ : velocity of ambient air
- $R_{th\ C-PB}$  is constant and  $R_{th\ C-A}$  is dependent on the air velocity.

Free convection is equal to an air velocity of approx. 0.2 – 0.3 m/s. See figure below.

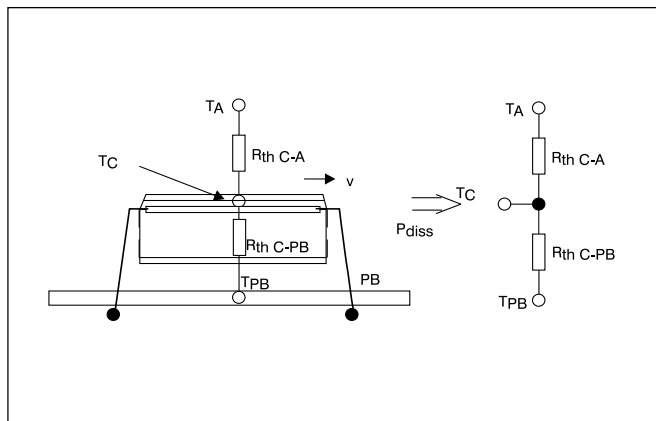
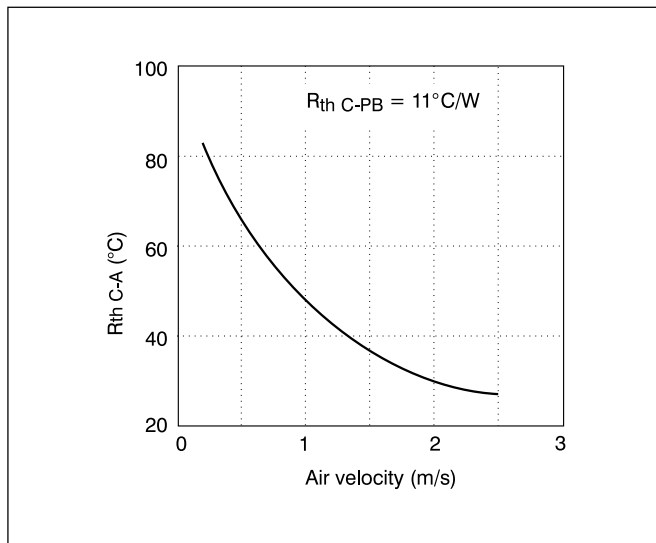

# Reflow Soldering Information

The PKF series of DC/DC power modules are manufactured in surface mount technology. Extra precautions must therefore be taken when reflow soldering the surface mount version. Neglecting the soldering information given below may result in permanent damage or significant degradation of power module performance.

The PKF series can be reflow soldered using IR, Natural Convection, Forced Convection or Combined IR/Convection Technologies. The high thermal mass of the component and its effect on  $\Delta T$  (°C) requires that particular attention be paid to other temperature sensitive components.

IR Reflow technology may require the overall profile time to be extended to approximately 8–10 minutes to ensure an acceptable  $\Delta T$ . Higher activity flux may be more suitable to overcome the increase in oxidation and to avoid flux burn-up.

The general profile parameters detailed in the diagram, with this extended time to reach peak temperatures, would then be suitable.

**Note!** These are maximum parameters. Depending on process variations, an appropriate margin must be added.

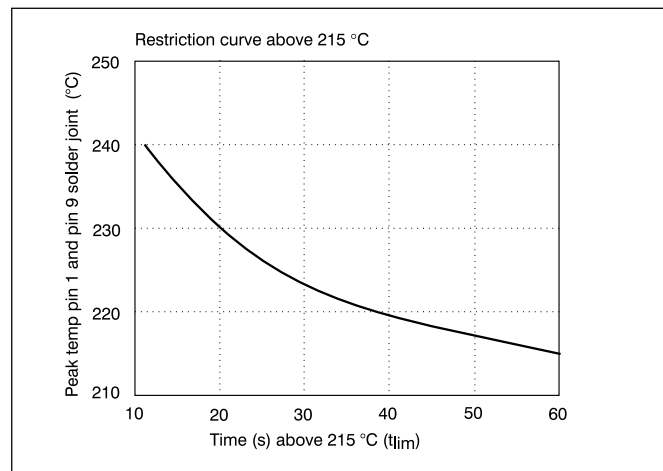
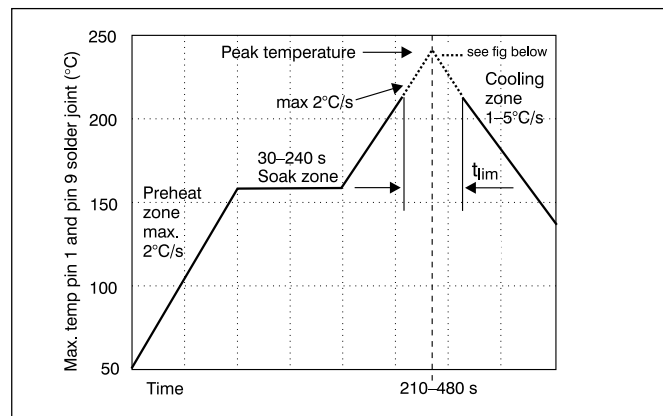

Palladium plating is used on the terminal pins. A pin temperature ( $T_p$ ) in excess of the solder fusing temperature (+183°C for Sn/Pb 63/37) for more than 25 seconds and a peak temperature above 195°C, is required to guarantee a reliable solder joint.

Both pin 1 and pin 9 must be monitored.

**No responsibility is assumed if these recommendations are not strictly followed.**

# Safety

The PKF Series DC/DC power modules are designed in accordance with EN 60 950, *Safety of information technology equipment including electrical business equipment*. SEMKO certificate no. 9709166.

The PKF power modules are recognized by UL and meet the applicable requirements in UL 1950 *Safety of information technology equipment*, the applicable Canadian safety requirements and UL 1012 *Standard for power supplies*.

The DC/DC power module shall be installed in an end-use equipment and considerations should be given to measuring the pin temperature to comply with  $T_{pmax}$  when in operation. Abnormal component tests are conducted with the input protected by an external 3 A fuse. The need for repeating these tests in the end-use appliance shall be considered if installed in a circuit having higher rated devices.

When the supply to the DC/DC power module meets all the requirements for SELV (<60 V dc), the output is considered to remain within SELV limits (level 3). The isolation is an operational insulation in accordance with EN 60 950.

The DC/DC power module is intended to be supplied by isolated secondary circuitry and shall be installed in compliance with the requirements of the ultimate application. If they are connected to a 60 V DC system reinforced insulation must be provided in the power supply that isolates the input from the mains. Single fault testing in the power supply must be performed in combination with the DC/DC power module to demonstrate that the output meets the requirement for SELV. One pole of the input and one pole of the output is to be grounded or both are to be kept floating.

The terminal pins are only intended for connection to mating connectors of internal wiring inside the end-use equipment.

These DC/DC power modules may be used in telephone equipment in accordance with paragraph 34 A.1 of UL 1459 (Standard for Telephone Equipment, second edition).

The galvanic isolation is verified in an electric strength test. Test voltage ( $V_{ISO}$ ) between input and output is 1,500 V dc for 60 s. In production the test duration may be decreased to 1 s.

The capacitor between input and output has a value of 1 nF and the leakage current is less than 1µA @ 53 V dc.

The case is designed in non-conductive epoxy. Its flammability rating meets UL 94V-0. The oxygen index is 34%.

# Electrical Data

## Fundamental circuit diagrams

### Single output

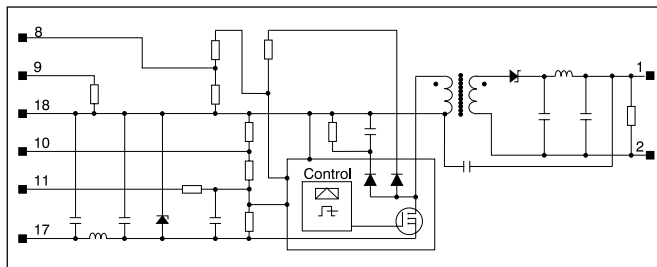

### Dual output (negative output 2)

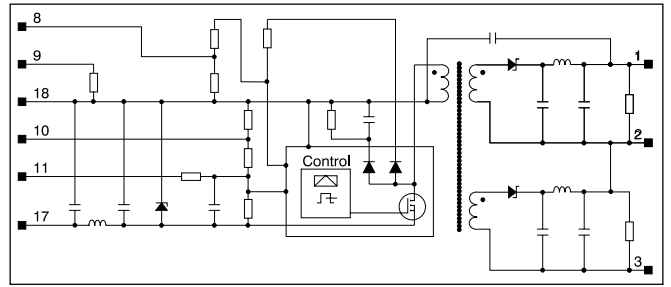

### Dual output (positive output 2)

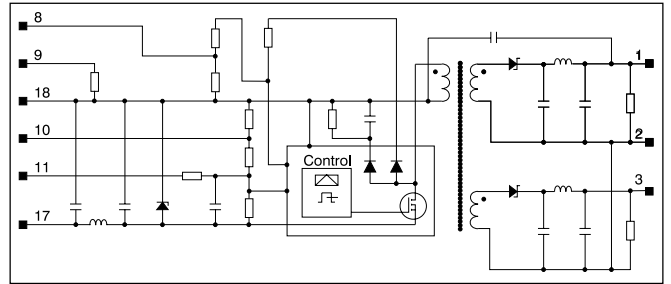

## Typical input characteristics

### HF Attenuation (input to output)

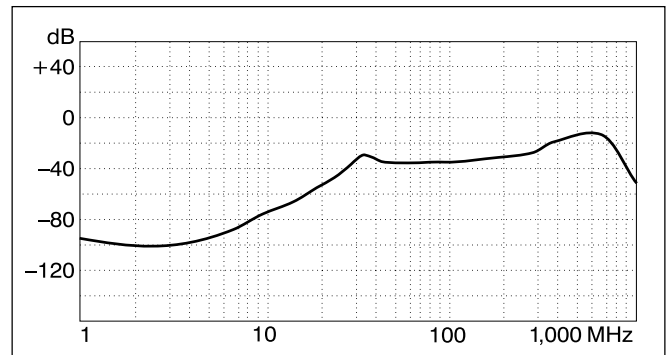

## Transient input voltage

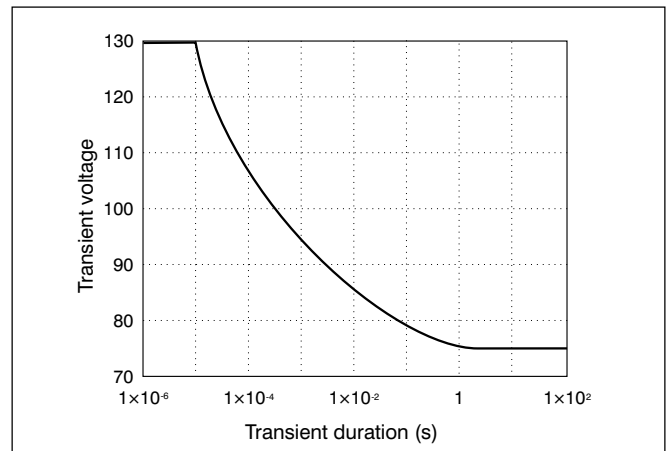

Single voltage pulse at +25°C ambient temperature.

# PKF 4310

$T_P = -30 \dots +85^\circ\text{C}$ ,  $V_I = 38 \dots 72\text{ V}$  and pin 8 connected to pin 9 unless otherwise specified.

## Output

Characteristics		Conditions		Output 1			Unit
				min	typ	max	
$V_{O_i}$	Output voltage initial setting and accuracy	$T_P = +25^\circ\text{C}$ , $I_O = 1.15\text{ A}$ , $V_I = 53\text{ V}$		2.07	2.12	2.17	V
	Output adjust range <sup>1)</sup>			1.76		2.47	V
$V_O$	Output voltage tolerance band	Long term drift included	$I_O = 0.1 \dots 1.0 \times I_{O\text{max}}$	2.01		2.28	V
			$I_O = 0.3 \dots 1.0 \times I_{O\text{max}}$	2.01		2.21	
	Idling voltage	$I_O = 0\text{ A}$			2.7	3.0	V
	Line regulation	$I_O = I_{O\text{max}}$	$V_I = 38 \dots 60\text{ V}$		20		mV
			$V_I = 50 \dots 72\text{ V}$		10		
	Load regulation	$I_O = 0.1 \dots 1.0 \times I_{O\text{max}}$ , $V_I = 53\text{ V}$		70		220	mV
$t_{tr}$	Load transient recovery time	$I_O = 0.1 \dots 1.0 \times I_{O\text{max}}$ , $V_I = 53\text{ V}$ load step = $0.5 \times I_{O\text{max}}$			100		$\mu\text{s}$
$V_{tr}$	Load transient voltage				+80		mV
					-135		mV
$T_{\text{coeff}}$	Temperature coefficient <sup>2)</sup>	$I_O = I_{O\text{max}}$ , $T_P = +40 \dots +90^\circ\text{C}$			-0.5		mV/ $^\circ\text{C}$
$t_r$	Ramp-up time	$I_O = I_{O\text{max}}$ , $0.1 \dots 0.9 \times V_O$ , $V_I = 53\text{ V}$			0.3		ms
$t_s$	Start-up time	$I_O = 0.1 \dots 1.0 \times I_{O\text{max}}$ , $V_I = 53\text{ V}$ From $V_I$ connection to $V_O = 0.9 \times V_{O_i}$			2.2		ms
$I_O$	Output current			0		1.5	A
$P_{O\text{max}}$	Max output power <sup>2)</sup>	Calculated value		3.2			W
$I_{\text{lim}}$	Current limiting threshold	$T_P < T_{P\text{max}}$ , $V_O = 1.9\text{ V}$		2.0		3.3	A
$I_{\text{sc}}$	Short circuit current	$V_O = 0.2 \dots 0.5\text{ V}$ , $T_A = +25^\circ\text{C}$			2.8		A
$V_{O\text{ac}}$	Output ripple & noise	$I_O = I_{O\text{max}}$	20 Hz ... 5 MHz		30	70	mV <sub>p-p</sub>
			0.6 ... 50 MHz			80	dB $\mu\text{V}$
SVR	Supply voltage rejection (ac)	$f = 100\text{ Hz}$ sine wave, $1\text{ V}_{p-p}$ , $V_I = 53\text{ V}$ ( $\text{SVR} = 20 \log(1\text{ V}_{p-p}/V_{O\text{p-p}})$ )			60		dB

<sup>1)</sup> See also Operating Information.

<sup>2)</sup> See Typical Characteristics.

## Miscellaneous

Characteristics		Conditions		min	typ	max	Unit
$\eta$	Efficiency	$I_O = I_{O\text{max}}$	$V_I = 53\text{ V}$	70	73		%
			$V_I = 67\text{ V}$	70	72		
$P_d$	Power dissipation		$V_I = 53\text{ V}$		1.2	1.4	W
			$V_I = 67\text{ V}$		1.2	1.4	

# PKF 4510

$T_P = -30 \dots +85^\circ\text{C}$ ,  $V_I = 38 \dots 72\text{ V}$  and pin 8 connected to pin 9 unless otherwise specified.

## Output

Characteristics		Conditions		Output 1			Unit
				min	typ	max	
$V_{O_i}$	Output voltage initial setting and accuracy	$T_P = +25^\circ\text{C}$ , $I_O = 1.5\text{ A}$ , $V_I = 53\text{ V}$		3.28	3.30	3.32	V
	Output adjust range <sup>1)</sup>			2.80		3.80	V
$V_O$	Output voltage tolerance band	Long term drift included	$I_O = 0.1 \dots 1.0 \times I_{O_{\text{max}}}$	3.17		3.50	V
			$I_O = 0.3 \dots 1.0 \times I_{O_{\text{max}}}$	3.17		3.42	
	Idling voltage	$I_O = 0\text{ A}$			3.65	4.0	V
	Line regulation	$I_O = I_{O_{\text{max}}}$	$V_I = 38 \dots 60\text{ V}$	25			mV
			$V_I = 50 \dots 72\text{ V}$	10			
	Load regulation	$I_O = 0.1 \dots 1.0 \times I_{O_{\text{max}}}$ , $V_I = 53\text{ V}$		70		220	mV
$t_{\text{tr}}$	Load transient recovery time	$I_O = 0.1 \dots 1.0 \times I_{O_{\text{max}}}$ , $V_I = 53\text{ V}$ load step = $0.5 \times I_{O_{\text{max}}}$		120			$\mu\text{s}$
$V_{\text{tr}}$	Load transient voltage			+150			mV
				-250			mV
$T_{\text{coeff}}$	Temperature coefficient <sup>2)</sup>	$I_O = I_{O_{\text{max}}}$ , $T_P = +40 \dots +90^\circ\text{C}$		-1.1			mV/ $^\circ\text{C}$
$t_r$	Ramp-up time	$I_O = I_{O_{\text{max}}}$ , $0.1 \dots 0.9 \times V_O$ , $V_I = 53\text{ V}$		0.3			ms
$t_s$	Start-up time	$I_O = 0.1 \dots 1.0 \times I_{O_{\text{max}}}$ , $V_I = 53\text{ V}$ From $V_I$ connection to $V_O = 0.9 \times V_{O_i}$		3			ms
$I_O$	Output current			0		1.5	A
$P_{O_{\text{max}}}$	Max output power <sup>2)</sup>	Calculated value		5			W
$I_{\text{lim}}$	Current limiting threshold	$T_P < T_{P_{\text{max}}}$ , $V_O = 2.5\text{ V}$		1.65		3.30	A
$I_{\text{sc}}$	Short circuit current	$V_O = 0.2 \dots 0.5\text{ V}$ , $T_A = +25^\circ\text{C}$		2.4			A
$V_{O_{\text{ac}}}$	Output ripple & noise	$I_O = I_{O_{\text{max}}}$	20 Hz ... 5 MHz	30	70		mV <sub>p-p</sub>
			0.6 ... 50 MHz		80		dB $\mu\text{V}$
SVR	Supply voltage rejection (ac)	f = 100 Hz sine wave, 1 V <sub>p-p</sub> , $V_I = 53\text{ V}$ (SVR = $20 \log(1 \text{ V}_{p-p}/V_{O_{p-p}})$ )		60			dB

<sup>1)</sup> See also Operating Information.

<sup>2)</sup> See Typical Characteristics.

## Miscellaneous

Characteristics		Conditions		min	typ	max	Unit
$\eta$	Efficiency	$I_O = I_{O_{\text{max}}}$	$V_I = 53\text{ V}$	75	79		%
			$V_I = 67\text{ V}$	75	79		
$P_d$	Power dissipation		$V_I = 53\text{ V}$		1.3	1.7	W
			$V_I = 67\text{ V}$		1.3	1.7	

# PKF 4611

$T_P = -30 \dots +85^\circ\text{C}$ ,  $V_I = 38 \dots 72\text{ V}$  and pin 8 connected to pin 9 unless otherwise specified.

## Output

Characteristics		Conditions		Output 1			Unit
				min	typ	max	
$V_{O_i}$	Output voltage initial setting and accuracy	$T_P = +25^\circ\text{C}$ , $I_O = 0.8\text{ A}$ , $V_I = 53\text{ V}$		5.02	5.05	5.08	V
	Output adjust range <sup>1)</sup>			4.30		5.80	V
$V_O$	Output voltage tolerance band	Long term drift included	$I_O = 0.1 \dots 1.0 \times I_{O_{\text{max}}}$	4.85		5.25	V
	Idling voltage	$I_O = 0\text{ A}$			5.6	6.0	V
	Line regulation	$I_O = I_{O_{\text{max}}}$	$V_I = 38 \dots 60\text{ V}$	25		mV	
			$V_I = 50 \dots 72\text{ V}$	10			
	Load regulation	$I_O = 0.1 \dots 1.0 \times I_{O_{\text{max}}}$ , $V_I = 53\text{ V}$		70		270	mV
$t_{\text{tr}}$	Load transient recovery time	$I_O = 0.1 \dots 1.0 \times I_{O_{\text{max}}}$ , $V_I = 53\text{ V}$ load step = $0.5 \times I_{O_{\text{max}}}$		150		$\mu\text{s}$	
$V_{\text{tr}}$	Load transient voltage			+150		mV	
				-250		mV	
$T_{\text{coeff}}$	Temperature coefficient <sup>2)</sup>	$I_O = I_{O_{\text{max}}}$ , $T_P = +40 \dots +90^\circ\text{C}$		-2		$\text{mV}/^\circ\text{C}$	
$t_r$	Ramp-up time	$I_O = I_{O_{\text{max}}}$ , $0.1 \dots 0.9 \times V_O$ , $V_I = 53\text{ V}$		1		ms	
$t_s$	Start-up time	$I_O = 0.1 \dots 1.0 \times I_{O_{\text{max}}}$ , $V_I = 53\text{ V}$ From $V_I$ connection to $V_O = 0.9 \times V_{O_i}$		3		ms	
$I_O$	Output current			0		1.2	A
$P_{O_{\text{max}}}$	Max output power <sup>2)</sup>	Calculated value		6		W	
$I_{\text{lim}}$	Current limiting threshold	$T_P < T_{P_{\text{max}}}$ , $V_O = 4.0\text{ V}$		1.4		2.4	A
$I_{\text{sc}}$	Short circuit current	$V_O = 0.2 \dots 0.5\text{ V}$ , $T_A = +25^\circ\text{C}$		1.9		A	
$V_{O_{\text{ac}}}$	Output ripple & noise	$I_O = I_{O_{\text{max}}}$	20 Hz...5 MHz	30	70	$\text{mV}_{\text{p-p}}$	
			0.6...50 MHz		80	$\text{dB}_{\mu\text{V}}$	
SVR	Supply voltage rejection (ac)	$f = 100\text{ Hz}$ sine wave, $1 V_{\text{p-p}}$ , $V_I = 53\text{ V}$ ( $\text{SVR} = 20 \log(1 V_{\text{p-p}}/V_{O_{\text{p-p}}})$ )		45		dB	

<sup>1)</sup> See also Operating Information.

<sup>2)</sup> See Typical Characteristics.

## Miscellaneous

Characteristics		Conditions		min	typ	max	Unit
$\eta$	Efficiency	$I_O = I_{O_{\text{max}}}$	$V_I = 53\text{ V}$	79	83		%
			$V_I = 67\text{ V}$	79	82		
$P_d$	Power dissipation		$V_I = 53\text{ V}$		1.2	1.6	W
			$V_I = 67\text{ V}$		1.3	1.6	



# PKF 4713

$T_P = -30 \dots +85^\circ\text{C}$ ,  $V_I = 38 \dots 72\text{ V}$  and pin 8 connected to pin 9 unless otherwise specified.

## Output

Characteristics		Conditions		Output 1			Unit	
				min	typ	max		
$V_{O_i}$	Output voltage initial setting and accuracy	$T_P = +25^\circ\text{C}$ , $I_O = 0.3\text{ A}$ , $V_I = 53\text{ V}$		11.83	12.00	12.18	V	
	Output adjust range <sup>1)</sup>			10.2 <sup>1)</sup>		13.8 <sup>1)</sup>	V	
$V_O$	Output voltage tolerance band	Long term drift included	$I_O = 0.1 \dots 1.0 \times I_{O_{\text{max}}}$	11.5		12.5	V	
	Idling voltage	$I_O = 0\text{ A}$ see page 15			14.3	22.0	V	
	Line regulation	$I_O = I_{O_{\text{max}}}$	$V_I = 38 \dots 60\text{ V}$	-30			mV	
			$V_I = 50 \dots 72\text{ V}$	-20				
	Load regulation	$I_O = 0.1 \dots 1.0 \times I_{O_{\text{max}}}$ , $V_I = 53\text{ V}$		230	340	650	mV	
$t_{\text{tr}}$	Load transient recovery time	$I_O = 0.1 \dots 1.0 \times I_{O_{\text{max}}}$ , $V_I = 53\text{ V}$ load step = $0.5 \times I_{O_{\text{max}}}$		300			$\mu\text{s}$	
$V_{\text{tr}}$	Load transient voltage			+200			mV	
		-490			mV			
$T_{\text{coeff}}$	Temperature coefficient <sup>2)</sup>	$I_O = I_{O_{\text{max}}}$ , $T_P = +40 \dots +90^\circ\text{C}$		-3.7			mV/ $^\circ\text{C}$	
$t_r$	Ramp-up time	$I_O = I_{O_{\text{max}}}$ , $0.1 \dots 0.9 \times V_O$ , $V_I = 53\text{ V}$		1			ms	
$t_s$	Start-up time	$I_O = 0.1 \dots 1.0 \times I_{O_{\text{max}}}$ , $V_I = 53\text{ V}$ From $V_I$ connection to $V_O = 0.9 \times V_{O_i}$		1	3	8	ms	
$I_O$	Output current			0		0.6	A	
$P_{O_{\text{max}}}$	Max output power <sup>2)</sup>	Calculated value		7			W	
$I_{\text{lim}}$	Current limiting threshold	$T_P < T_{P_{\text{max}}}$ , $V_O = 10\text{ V}$		0.65			1.2	A
$I_{\text{sc}}$	Short circuit current			1.2			A	
$V_{O_{\text{ac}}}$	Output ripple & noise	$I_O = I_{O_{\text{max}}}$	20 Hz ... 5 MHz	30	70		mV <sub>p-p</sub>	
			0.6 ... 50 MHz	80			dB $\mu\text{V}$	
SVR	Supply voltage rejection (ac)	f = 100 Hz sine wave, 1 $V_{p-p}$ , $V_I = 53\text{ V}$ (SVR = $20 \log(1 \frac{V_{p-p}}{V_{O_{p-p}}})$ )		45	60		dB	

<sup>1)</sup> Can be adjusted to 15 V, see Operating Information.

<sup>2)</sup> See Typical Characteristics.

## Miscellaneous

Characteristics		Conditions		min	typ	max	Unit	
$\eta$	Efficiency	$I_O = I_{O_{\text{max}}}$	$V_I = 53\text{ V}$	80	83		%	
			$V_I = 67\text{ V}$	80	83			
$P_d$	Power dissipation		$V_I = 53\text{ V}$	1.4		1.8		W
			$V_I = 67\text{ V}$	1.4		1.8		

# PKF 4621

$T_P = -30 \dots +85^\circ\text{C}$ ,  $V_I = 38 \dots 72\text{ V}$  and pin 8 connected to pin 9 unless otherwise specified.  
 $I_{O1\text{ nom}} = 0.25\text{ A}$ ,  $I_{O2\text{ nom}} = 0.25\text{ A}$ .

## Output

Characteristics		Conditions		Output 1			Output 2 <sup>4)</sup>			Unit	
				min	typ	max	min	typ	max		
$V_{O_i}$	Output voltage initial setting and accuracy	$T_P = +25^\circ\text{C}$ , $I_{O1} = I_{O2} = 0.15\text{ A}$ , $V_I = 53\text{ V}$		11.83	12.00	12.18	12.00 <sup>4)</sup>			V	
	Output adjust range <sup>1)</sup>			10.20		13.80 <sup>1)</sup>		10.20	13.80 <sup>1)</sup>		
$V_O$	Output voltage tolerance band <sup>2)</sup>	Long term drift included	$I_O = 0.1 \dots 1.0 \times I_{O\text{ max}}$	11.50		12.50		11.40	12.60		V
	Idling voltage	$I_O = 0\text{ A}$		14.3		22.0		14.3	22.0		V
	Line regulation	$I_O = I_{O\text{ nom}}$	$V_I = 38 \dots 60\text{ V}$	-30		-30		mV			
			$V_I = 50 \dots 72\text{ V}$	-20		-20					
	Load regulation	$I_{O1} = 0.1 \dots 1.0 \times I_{O1\text{ nom}}$ , $I_{O2} = I_{O2\text{ nom}}$ , $V_I = 53\text{ V}$		200	320	650	200	330	650	mV	
$t_{tr}$	Load transient recovery time	$I_{O1} = 0.1 \dots 1.0 \times I_{O1\text{ nom}}$ , load step = $0.1\text{ A}$ , $I_{O2} = I_{O2\text{ nom}}$ , $V_I = 53\text{ V}$		300			300			$\mu\text{s}$	
$V_{tr}$	Load transient voltage			+200			+200			mV	
				-490			-490			mV	
$T_{\text{coeff}}$	Temperature coefficient <sup>2)</sup>	$I_O = I_{O\text{ nom}}$ , $T_P = +40 \dots +90^\circ\text{C}$		-3.7			-3.7			mV/ $^\circ\text{C}$	
$t_r$	Ramp-up time	$I_O = I_{O\text{ nom}}$ , $0.1 \dots 0.9 \times V_O$ , $V_I = 53\text{ V}$		1			1			ms	
$t_s$	Start-up time	$I_O = 0.1 \dots 1.0 \times I_{O\text{ nom}}$ , $V_I = 53\text{ V}$ From $V_I$ connection to $V_O = 0.9 \times V_{O_i}$		3			3			ms	
$I_O$	Output current			0	0.5		0	0.5		A	
$P_{O\text{ max}}$	Max total output power <sup>2)</sup>	Calculated value		6						W	
$I_{\text{lim}}$	Current limiting threshold <sup>3)</sup>	$T_P < T_{P\text{ max}}$ , $V_O = 10\text{ V}$		1.0			1.0			A	
$I_{\text{sc}}$	Short circuit current	$V_O = 0.2 \dots 0.5\text{ V}$ , $T_A = +25^\circ\text{C}$		1.2			1.2			A	
$V_{O\text{ ac}}$	Output ripple & noise	$I_O = I_{O\text{ nom}}$	20 Hz...5 MHz	50	100		50	100		mV <sub>p-p</sub>	
			0.6...50 MHz	80			80			dB $\mu\text{V}$	
SVR	Supply voltage rejection (ac)	$f = 100\text{ Hz}$ sine wave, $1\text{ V}_{p-p}$ , $V_I = 53\text{ V}$ ( $\text{SVR} = 20 \log(1\text{ V}_{p-p}/V_{O\text{ p-p}})$ )		45			45			dB	

<sup>1)</sup> Can be adjusted to 15 V, see Operating Information.

<sup>2)</sup> See Typical Characteristics.

<sup>3)</sup>  $I_{\text{lim}}$  on each output is set by the total load.

<sup>4)</sup> Output voltage on Output 2 is negative (-12V).

## Miscellaneous

Characteristics		Conditions		min	typ	max	Unit	
$\eta$	Efficiency	$I_O = I_{O\text{ nom}}$	$V_I = 53\text{ V}$	79	83		%	
			$V_I = 67\text{ V}$	79	82			
$P_d$	Power dissipation		$V_I = 53\text{ V}$	1.2		1.6		W
			$V_I = 67\text{ V}$	1.3		1.6		

# PKF 4622

$T_P = -30 \dots +85^\circ\text{C}$ ,  $V_I = 38 \dots 72\text{ V}$  and pin 8 connected to pin 9 unless otherwise specified.  
 $I_{O1\text{nom}} = 0.6\text{ A}$ ,  $I_{O2\text{nom}} = 0.6\text{ A}$ .

## Output

Characteristics		Conditions		Output 1			Output 2 <sup>4)</sup>			Unit
				min	typ	max	min	typ	max	
$V_{O_i}$	Output voltage initial setting and accuracy	$T_P = +25^\circ\text{C}$ , $I_{O1}=I_{O2}=0.3\text{ A}$ , $V_I = 53\text{ V}$		5.02	5.05	5.08	5.05 <sup>4)</sup>			V
	Output adjust range <sup>1)</sup>			4.30		5.80	4.30		5.80	V
$V_O$	Output voltage tolerance band <sup>2)</sup>	Long term drift included	$I_O = 0.1 \dots 1.0 \times I_{O\text{max}}$	4.85		5.25	4.80		5.30	V
	Idling voltage	$I_O = 0\text{ A}$			5.4	6.0		5.4	6.0	V
	Line regulation	$I_O = I_{O\text{nom}}$	$V_I = 38 \dots 60\text{ V}$	10			10			mV
			$V_I = 50 \dots 72\text{ V}$	10			10			
	Load regulation	$I_{O1} = 0.1 \dots 1.0 \times I_{O1\text{nom}}$ , $I_{O2} = I_{O2\text{nom}}$ , $V_I = 53\text{ V}$		70		270	70		270	mV
$t_{\text{tr}}$	Load transient recovery time	$I_{O1} = 0.1 \dots 1.0 \times I_{O1\text{nom}}$ , load step = 0.15A, $I_{O2} = I_{O2\text{nom}}$ , $V_I = 53\text{ V}$		190			190			$\mu\text{s}$
$V_{\text{tr}}$	Load transient voltage			+100			+100			mV
				-100			-100			mV
$T_{\text{coeff}}$	Temperature coefficient <sup>2)</sup>	$I_O = I_{O\text{nom}}$ , $T_P = +40 \dots +90^\circ\text{C}$		-2			-2			mV/ $^\circ\text{C}$
$t_r$	Ramp-up time	$I_O = I_{O\text{nom}}$ , $0.1 \dots 0.9 \times V_O$ , $V_I = 53\text{ V}$		1			1			ms
$t_s$	Start-up time	$I_O = 0.1 \dots 1.0 \times I_{O\text{nom}}$ , $V_I = 53\text{ V}$ From $V_I$ connection to $V_O = 0.9 \times V_{O_i}$		3			3			ms
$I_O$	Output current			0	0.6	1.0	0	0.6	1.0	A
$P_{O\text{max}}$	Max total output power <sup>2)</sup>	Calculated value		6						W
$I_{\text{lim}}$	Current limiting threshold <sup>3)</sup>	$T_P < T_{P\text{max}}$ , $V_O = 4\text{ V}$		2.4			2.4			A
$I_{\text{sc}}$	Short circuit current	$V_O = 0.2 \dots 0.5\text{ V}$ , $T_A = +25^\circ\text{C}$		1.9			1.9			A
$V_{O\text{ac}}$	Output ripple & noise	$I_O = I_{O\text{nom}}$	20 Hz...5 MHz	50	100		50	100	mV <sub>p-p</sub>	
			0.6...50 MHz	80			80			dB $\mu\text{V}$
SVR	Supply voltage rejection (ac)	f = 100 Hz sine wave, 1 V <sub>p-p</sub> , $V_I = 53\text{ V}$ (SVR = 20 log (1 V <sub>p-p</sub> /V <sub>O-p-p</sub> ))		45			45			dB

<sup>1)</sup> See Operating Information.

<sup>2)</sup> See Typical Characteristics.

<sup>3)</sup>  $I_{\text{lim}}$  on each output is set by the total load.

<sup>4)</sup> Output voltage on Output 2 is negative (-5V).

## Miscellaneous

Characteristics		Conditions		min	typ	max	Unit
$\eta$	Efficiency	$I_O = I_{O\text{nom}}$	$V_I = 53\text{ V}$	79	83		%
			$V_I = 67\text{ V}$	79	83		
$P_d$	Power dissipation		$V_I = 53\text{ V}$		1.2	1.6	W
			$V_I = 67\text{ V}$		1.2	1.6	

# PKF 4628

$T_P = -30 \dots +85^\circ\text{C}$ ,  $V_I = 38 \dots 72\text{ V}$  and pin 8 connected to pin 9 unless otherwise specified.

$I_{O1\text{nom}} = 0.6\text{ A}$ ,  $I_{O2\text{nom}} = 0.9\text{ A}$ .

## Output

Characteristics		Conditions		Output 1			Output 2			Unit			
				min	typ	max	min	typ	max				
$V_{O1}$	Output voltage initial setting and accuracy	$T_P = +25^\circ\text{C}$ , $I_{O1} = 0.6\text{ A}$ , $I_{O2} = 0.9\text{ A}$ , $V_I = 53\text{ V}$		5.20			3.25	3.27	3.29	V			
	Output adjust range <sup>1)</sup>			4.43			5.97			2.80	3.80	V	
$V_O$	Output voltage tolerance band <sup>2)</sup>	Long term drift included	$I_O = 0.1 \dots 1.0 \times I_{O\text{max}}$		4.94			5.46			3.17	3.42	V
	Idling voltage	$I_{O1} = I_{O2} = 0\text{ A}$		5.80			6.54			3.70	4.29	V	
	Line regulation	$I_O = I_{O\text{nom}}$	$V_I = 38 \dots 60\text{ V}$		25			25			mV		
			$V_I = 50 \dots 72\text{ V}$		25			10					
	Load regulation	$I_{O1} = 0.1 \dots 1.0 \times I_{O1\text{nom}}$ , $I_{O2} = I_{O2\text{nom}}$ , $V_I = 53\text{ V}$		50			270			70	270	mV	
$t_{\text{tr}}$	Load transient recovery time	$I_{O1} = 0.1 \dots 1.0 \times I_{O1\text{nom}}$ , load step = $0.15\text{ A}$ , $I_{O2} = I_{O2\text{nom}}$ , $V_I = 53\text{ V}$		150			150			$\mu\text{s}$			
$V_{\text{tr}}$	Load transient voltage			+150			+150			mV			
				-250			-250			mV			
$T_{\text{coeff}}$	Temperature coefficient <sup>2)</sup>	$I_O = I_{O\text{nom}}$ , $T_P = +40 \dots +90^\circ\text{C}$		-1.8			-1			$\text{mV}/^\circ\text{C}$			
$t_r$	Ramp-up time	$I_O = I_{O\text{nom}}$ , $0.1 \dots 0.9 \times V_O$ , $V_I = 53\text{ V}$		1			1			ms			
$t_s$	Start-up time	$I_O = 0.1 \dots 1.0 \times I_{O\text{nom}}$ , $V_I = 53\text{ V}$ From $V_I$ connection to $V_O = 0.9 \times V_{O1}$		3			3			ms			
$I_O$	Output current			0	0.6	1.0	0	0.9	1.0	A			
$P_{O\text{max}}$	Max total output power <sup>2)</sup>	Calculated value		6						W			
$I_{\text{lim}}$	Current limiting threshold <sup>3)</sup>	$T_P < T_{P\text{max}}$ , $V_{O1} = 4\text{ V}$ , $V_{O2} = 2.5\text{ V}$		2.0			2.8			A			
$I_{\text{sc}}$	Short circuit current	$V_O = 0.2 \dots 0.5\text{ V}$ , $T_A = +25^\circ\text{C}$		1.9			2.4			A			
$V_{O\text{ac}}$	Output ripple & noise	$I_O = I_{O\text{nom}}$	20 Hz...5 MHz		50			100			$\text{mV}_{\text{p-p}}$		
			0.6...50 MHz		80			80			$\text{dB}\mu\text{V}$		
SVR	Supply voltage rejection (ac)	$f = 100\text{ Hz}$ sine wave, $1\text{ V}_{\text{p-p}}$ , $V_I = 53\text{ V}$ ( $\text{SVR} = 20 \log(1\text{ V}_{\text{p-p}}/\text{V}_{\text{O p-p}})$ )		45			45			dB			

<sup>1)</sup> See Operating Information.

<sup>2)</sup> See Typical Characteristics.

<sup>3)</sup>  $I_{\text{lim}}$  on each output is set by the total load.

## Miscellaneous

Characteristics		Conditions		min	typ	max	Unit
$\eta$	Efficiency	$I_O = I_{O\text{nom}}$	$V_I = 53\text{ V}$	76	80		%
			$V_I = 67\text{ V}$	76	80		
$P_d$	Power dissipation	$I_O = I_{O\text{nom}}$	$V_I = 53\text{ V}$		1.5	1.9	W
			$V_I = 67\text{ V}$		1.5	1.9	

# PKF 4629

$T_P = -30 \dots +85^\circ\text{C}$ ,  $V_I = 38 \dots 72\text{ V}$  and pin 8 connected to pin 9 unless otherwise specified.

$I_{O1\text{nom}} = 0.8\text{ A}$ ,  $I_{O2\text{nom}} = 0.12\text{ A}$ .

## Output

Characteristics		Conditions		Output 1			Output 2 <sup>4)</sup>			Unit	
				min	typ	max	min	typ	max		
$V_{O_i}$	Output voltage initial setting and accuracy	$T_P = +25^\circ\text{C}$ , $I_{O1} = I_{O1\text{nom}}$ , $I_{O2} = I_{O2\text{nom}}$ , $V_I = 53\text{ V}$		5.02	5.05	5.08	12.40 <sup>4)</sup>			V	
	Output adjust range <sup>1)</sup>			4.30		5.80		10.20	13.80		V
$V_O$	Output voltage tolerance band <sup>2)</sup>	Long term drift included	$I_O = 0.1 \dots 1.0 \times I_{O\text{max}}$	4.90		5.30		11.90	12.90		V
	Idling voltage	$I_{O1} = I_{O2} = 0\text{ A}$		5.4		6.0		14.3	22.0		V
	Line regulation	$I_O = I_{O\text{nom}}$	$V_I = 38 \dots 60\text{ V}$	10		-50				mV	
			$V_I = 50 \dots 72\text{ V}$	10		-20					
	Load regulation	$I_{O1} = 0.1 \dots 1.0 \times I_{O1\text{nom}}$ , $I_{O2} = I_{O2\text{nom}}$ , $V_I = 53\text{ V}$		70		270		50	100	300	mV
$t_{tr}$	Load transient recovery time	$I_{O1} = 0.1 \dots 1.0 \times I_{O1\text{nom}}$ , load step = 0.15A, $I_{O2} = I_{O2\text{nom}}$ , $V_I = 53\text{ V}$		190		190				$\mu\text{s}$	
$V_{tr}$	Load transient voltage			+150		+200				mV	
		-250		-490				mV			
$T_{\text{coeff}}$	Temperature coefficient <sup>2)</sup>	$I_O = I_{O\text{nom}}$ , $T_P = +40 \dots +90^\circ\text{C}$		-2.0		-3.7				$\text{mV}/^\circ\text{C}$	
$t_r$	Ramp-up time	$I_O = I_{O\text{nom}}$ , $0.1 \dots 0.9 \times V_O$ , $V_I = 53\text{ V}$		1		1				ms	
$t_s$	Start-up time	$I_O = 0.1 \dots 1.0 \times I_{O\text{nom}}$ , $V_I = 53\text{ V}$ From $V_I$ connection to $V_O = 0.9 \times V_{O_i}$		3		3				ms	
$I_O$	Output current			0	0.80	1.20	0	0.12	0.50	A	
$P_{O\text{max}}$	Max total output power <sup>2)</sup>	Calculated value		7						W	
$I_{\text{lim}}$	Current limiting threshold <sup>3)</sup>	$T_P < T_{P\text{max}}$ , $V_{O1} = 4\text{ V}$ , $V_{O2} = 10\text{ V}$		2.4		1.0				A	
$I_{\text{sc}}$	Short circuit current	$V_O = 0.2 \dots 0.5\text{ V}$ , $T_A = +25^\circ\text{C}$		1.9		1.0				A	
$V_{O\text{ac}}$	Output ripple & noise	$I_O = I_{O\text{nom}}$	20 Hz...5 MHz	50	100	50	100			$\text{mV}_{p-p}$	
			0.6...50 MHz	80		80				$\text{dB}\mu\text{V}$	
SVR	Supply voltage rejection (ac)	$f = 100\text{ Hz}$ sine wave, $1\text{ V}_{p-p}$ , $V_I = 53\text{ V}$ ( $\text{SVR} = 20 \log(1\text{ V}_{p-p}/V_{O\text{p-p}})$ )		45		45				dB	

<sup>1)</sup> See Operating Information.

<sup>2)</sup> See Typical Characteristics.

<sup>3)</sup>  $I_{\text{lim}}$  on each output is set by the total load.

<sup>4)</sup> Output voltage on Output 2 is negative (-12V).

## Miscellaneous

Characteristics		Conditions		min	typ	max	Unit	
$\eta$	Efficiency	$I_O = I_{O\text{nom}}$	$V_I = 53\text{ V}$	80	84			%
			$V_I = 67\text{ V}$	80	83			
$P_d$	Power dissipation		$V_I = 53\text{ V}$	1.1		1.6		W
			$V_I = 67\text{ V}$	1.2		1.6		

# Typical Characteristics

## PKF 4310

Output characteristic (typ)

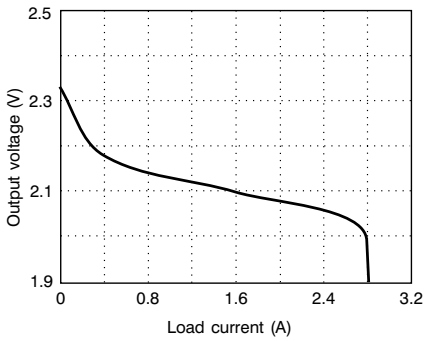

Power derating

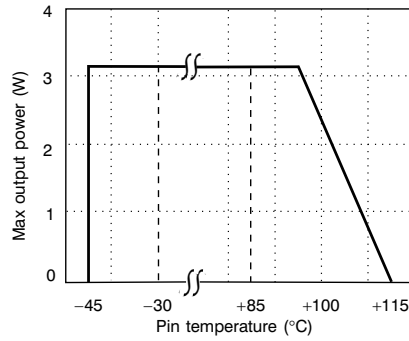

Efficiency (typ) @ T<sub>A</sub> = +25°C

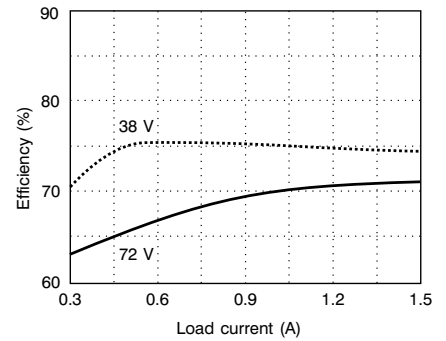

Temperature coefficient

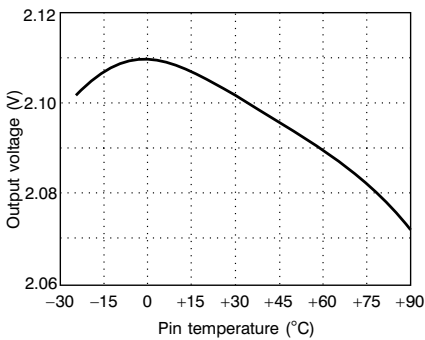

Turn-on/turn-off input voltage

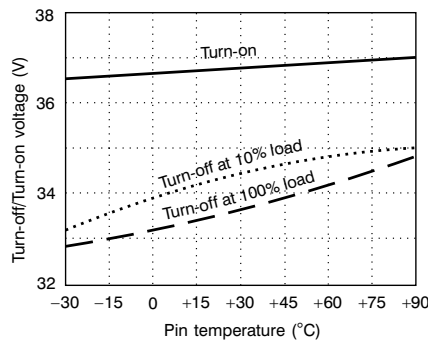

## PKF 4510

Output characteristic (typ)

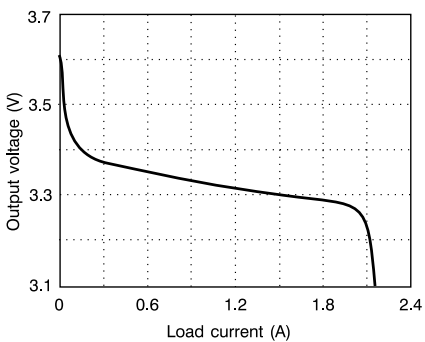

Power derating

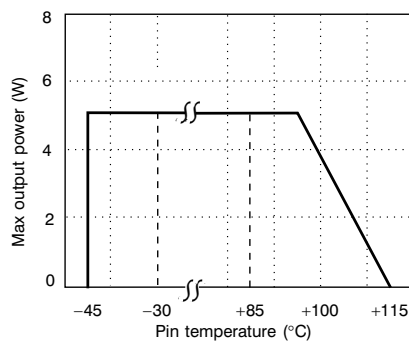

Efficiency (typ) @ T<sub>A</sub> = +25°C

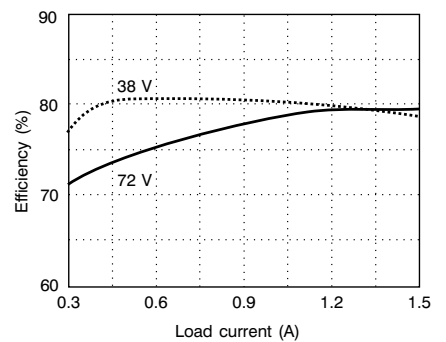

Temperature coefficient

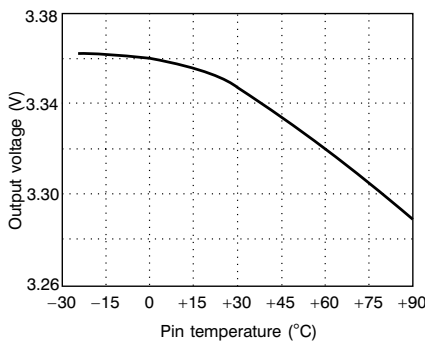

Turn-on/turn-off input voltage

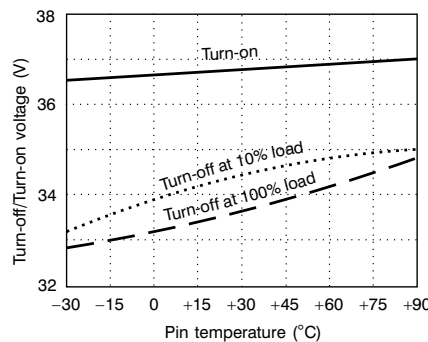

## PKF 4611

**Output characteristic (typ)**

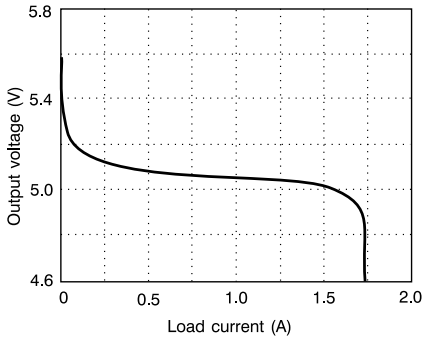

**Power derating**

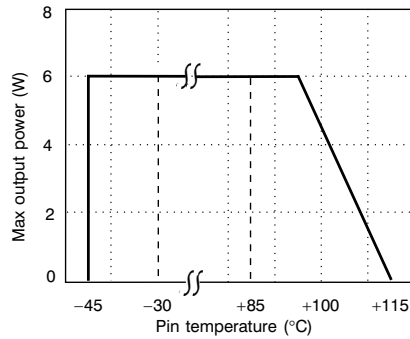

**Efficiency (typ) @  $T_A = +25^\circ\text{C}$**

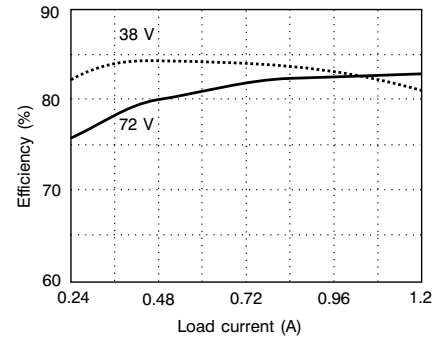

**Temperature coefficient**

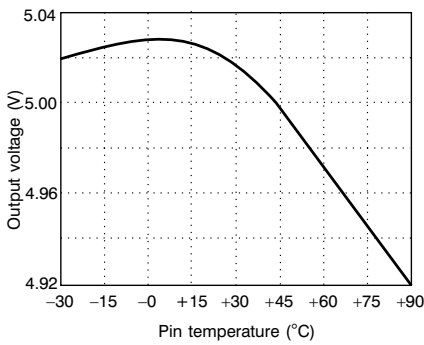

**Turn-on/turn-off input voltage**

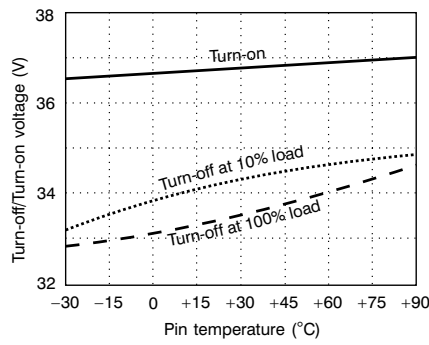

## PKF 4713

**Output characteristic (typ)**

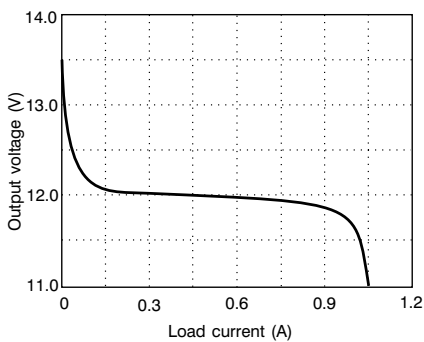

**Power derating**

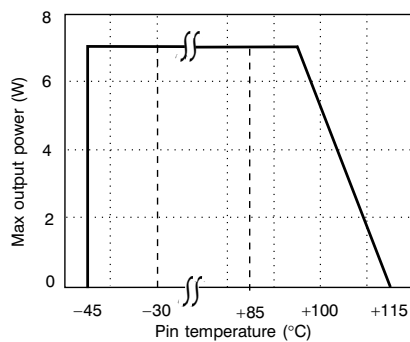

**Efficiency (typ) @  $T_A = +25^\circ\text{C}$**

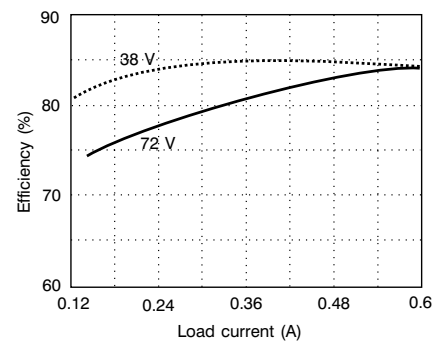

**Temperature coefficient**

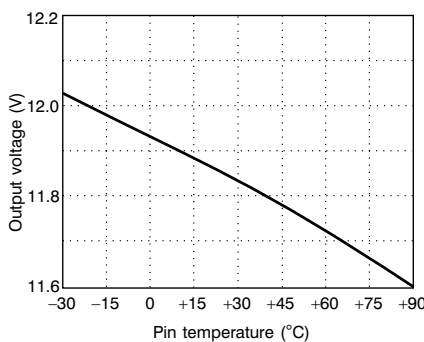

**Turn-on/turn-off input voltage**

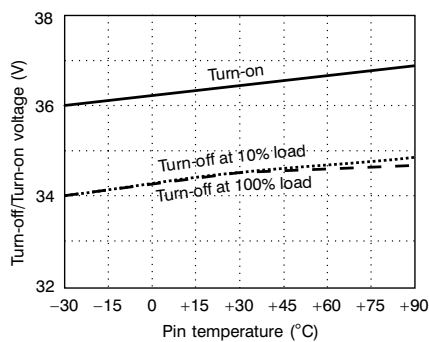

**Idling voltage (typ)**

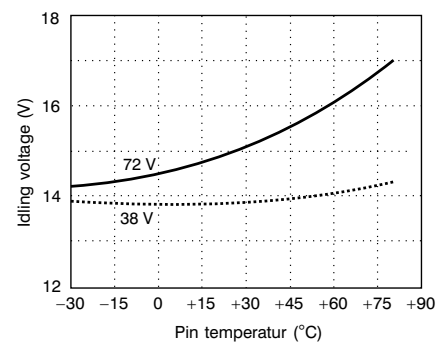

# Typical Characteristics

## PKF 4621

Cross regulation output 1 (+12V)

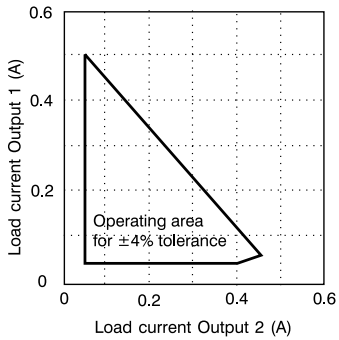

Cross regulation output 2 (-12V)

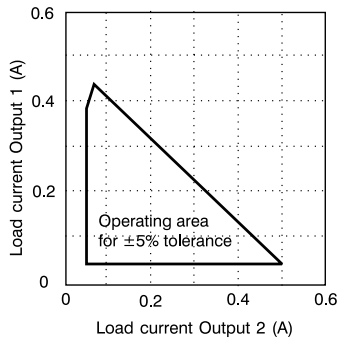

Power derating

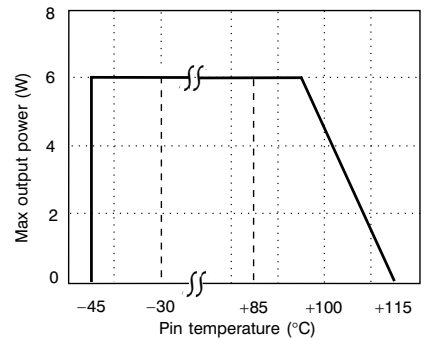

Efficiency (typ) @  $T_A = +25^\circ\text{C}$

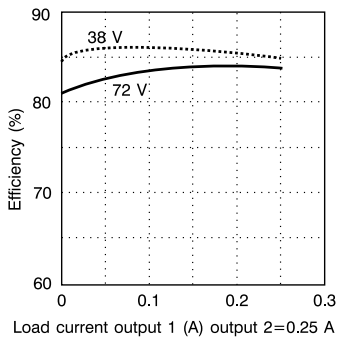

Temperature coefficient

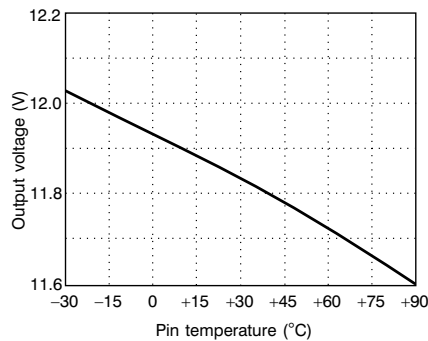

Turn-on/turn-off input voltage

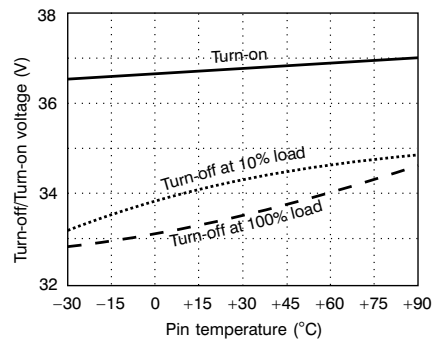

## PKF 4622

Cross regulation output 1 (+5V)

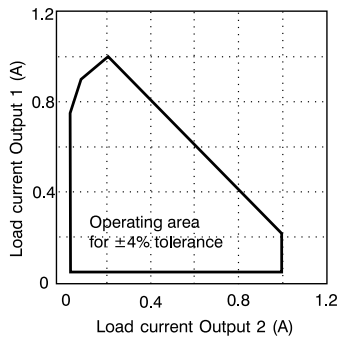

Cross regulation output 2(-5V)

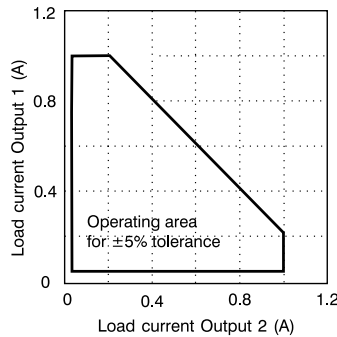

Power derating

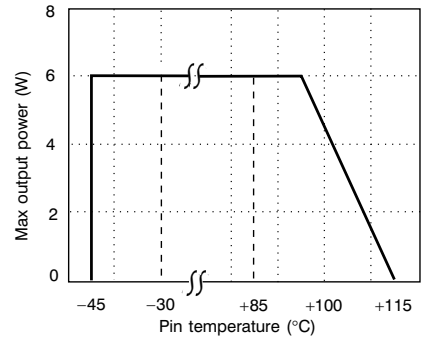

Efficiency (typ) @  $T_A = +25^\circ\text{C}$

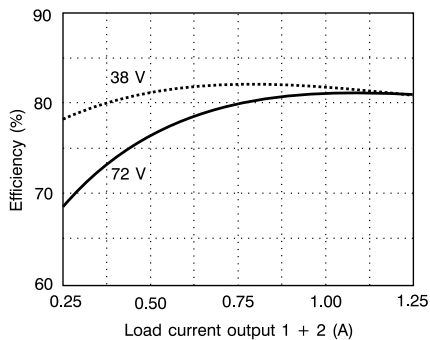

Temperature coefficient

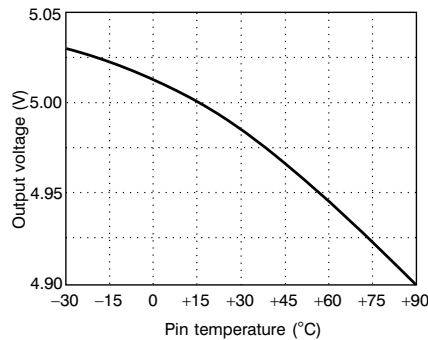

Turn-on/turn-off input voltage

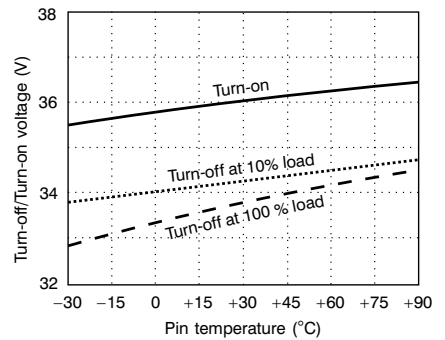



## PKF 4628

**Cross regulation output 1 (+5V)**

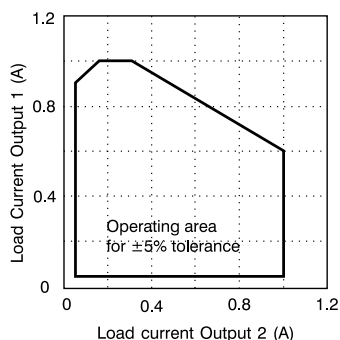

**Cross regulation output 2 (+3.3V)**

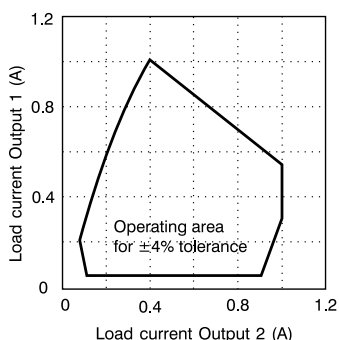

**Power derating**

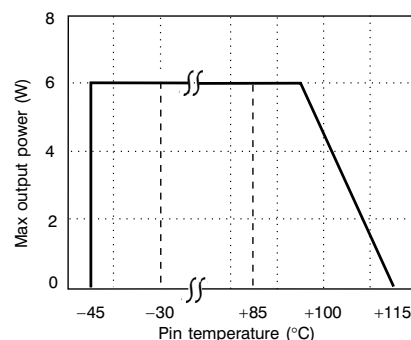

**Efficiency (typ) @ T<sub>A</sub> = +25°C**

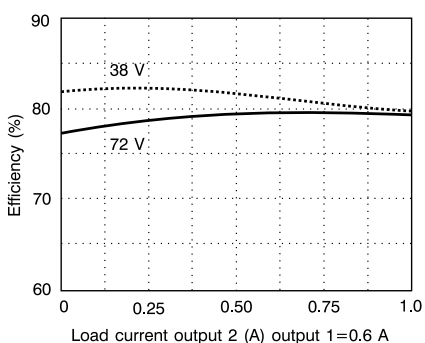

**Temperature coefficient**

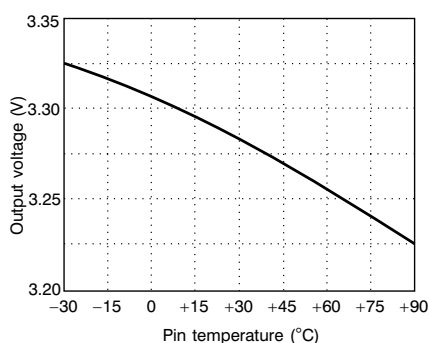

**Turn-on/turn-off input voltage**

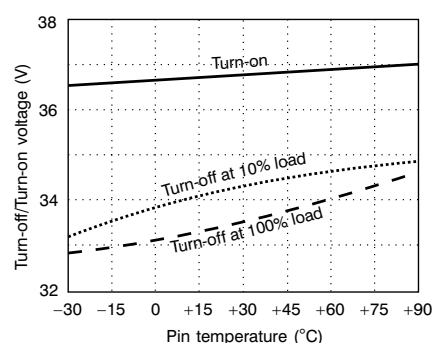

## PKF 4629

**Cross regulation output 1 (+5V)**

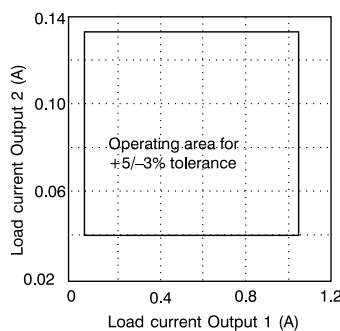

**Cross regulation output 2 (-12V)**

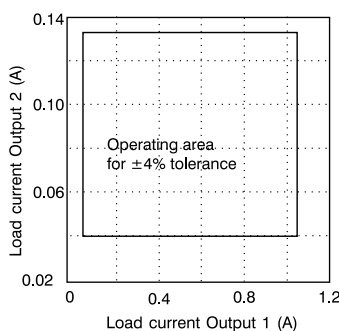

**Power derating**

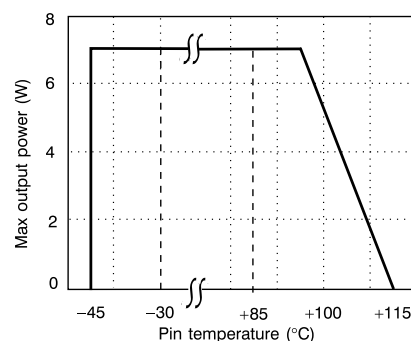

**Efficiency (typ) @ T<sub>A</sub> = +25°C**

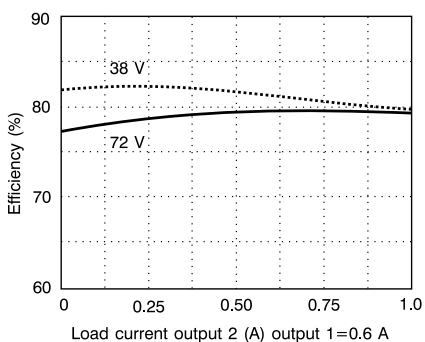

**Temperature coefficient**

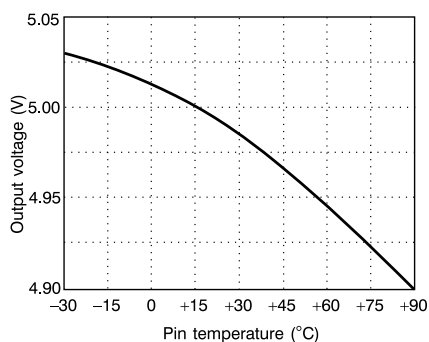

**Turn-on/turn-off input voltage**

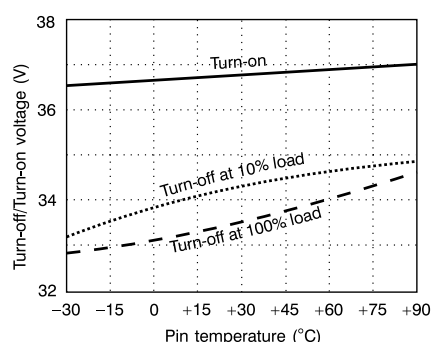

# EMC Specifications

The PKF power module is mounted on a double sided printed circuit board (PB) with groundplane during EMC measurements. The fundamental switching frequency is  $485 \text{ kHz} \pm 15\%$  @  $I_O = (0.5 \dots 1.0) \times I_{Omax}$ .

## Conducted EMI (input terminals)

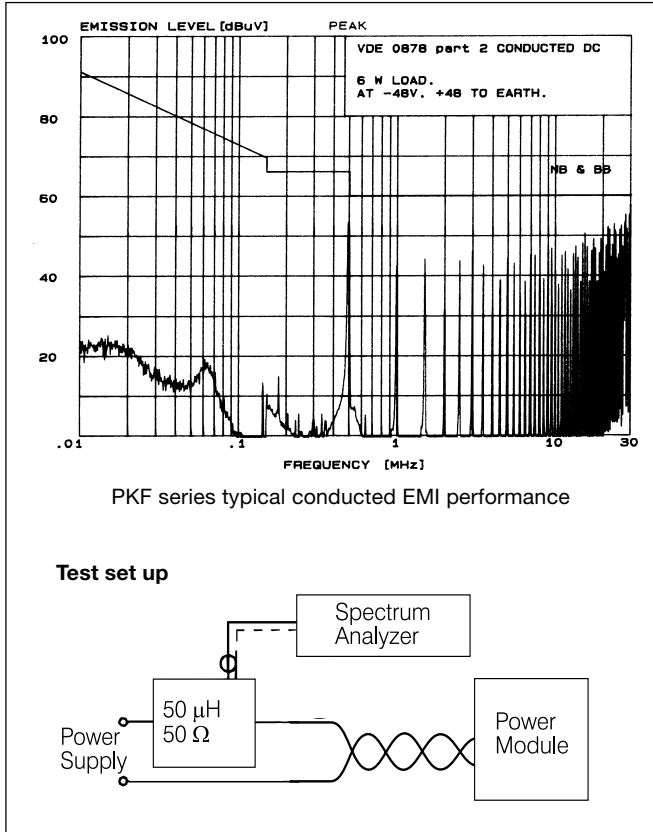

The PKF meets class A in VDE 0871/0878, FCC Part 15J, and CISPR 22 (EN 55022).

## Radiated EMI

Radiated emission of electromagnetic fields is measured at 10 m distance.

30...100 MHz	60 dB μV/m
100...200 MHz	40 dB μV/m
200...230 MHz	30 dB μV/m
230...1,000 MHz	35 dB μV/m
1...10 GHz	46 dB μV/m

## Conducted EMS

Electro Magnetic Susceptibility is measured by injection of electrical disturbances on the input terminals. No deviation outside the  $V_O$  tolerance band will occur under the following conditions:

Frequency range	Voltage level
0.15...300 MHz	1.0 V <sub>rms</sub>

The signal is amplitude modulated with 1 kHz/80% and applied both differential and common mode.

## Operating Frequency (typ)

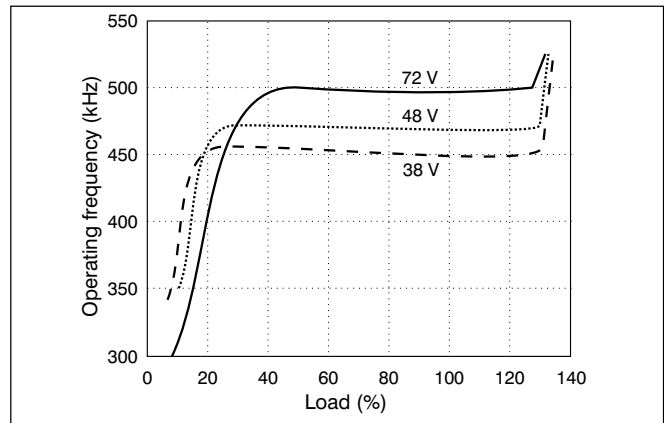
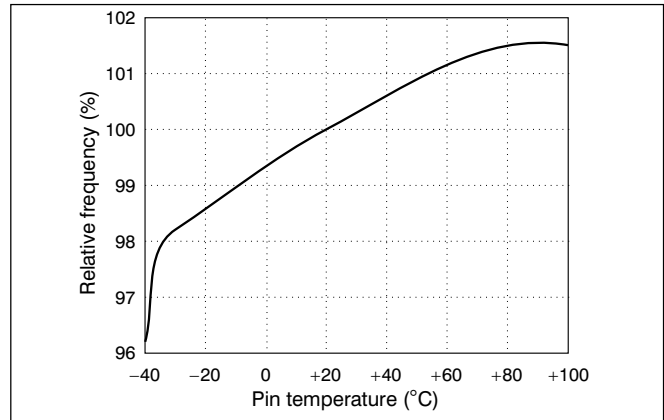

The operating frequency vs. load and input voltage (72 V, 48 V and 38 V).  $T_p = +25^\circ\text{C}$ .

## Radiated EMS (Electro-Magnetic Fields)

Radiated EMS is measured according to test methods in IEC Standard publ. 801-3. No deviation outside the  $V_O$  tolerance band will occur under the following conditions:

Frequency range	Voltage level
0.01...200 MHz	3 V <sub>rms</sub> /m
200...1,000 MHz	3 V <sub>rms</sub> /m
1...12 GHz	10 V <sub>rms</sub> /m

## ESD

Electro Static Discharge is tested according to IEC publ. 801-2. No destruction will occur if the following voltage levels are applied to any of the terminal pins:

Test	Voltage level
Air discharge	±4 kV
Contact discharge	±2 kV

## EFT

Electrical Fast Transients on the input terminals could affect the output voltage regulation causing functional errors on the Printed Board Assembly (PBA). The PKF power module withstand EFT levels of 0.5 kV keeping  $V_O$  within the tolerance band and 2.0 kV without destruction. Tested according to IEC publ. 801-4.

## Output Ripple & Noise ( $V_{Oac}$ )

Output ripple is measured as the peak to peak voltage of the fundamental switching frequency.

# Operating Information

## Fuse Considerations

To prevent excessive current from flowing through the input supply line, in the case of a short-circuit across the converter input, an external fuse should be installed in the non-earthed input supply line. We recommend using a fuse rated at approximately 2 to 4 times the value calculated in the formula below:

$$I_{in,max} = \frac{P_{O,max}}{(\eta_{min} \times V_{Imin})}$$

Refer to the fuse manufacturer for further information.

## Remote Control (RC)

Turn-on or turn-off can be realized by using the RC-pin. Normal operation is achieved if pin 11 is open (NC). If pin 11 is connected to pin 17 the power module turns off. To ensure safe turn-off the voltage difference between pin 11 and 17 shall be less than 1.0 V. RC is TTL open collector compatible output with a sink capacity >100 μA (see fig. 1).

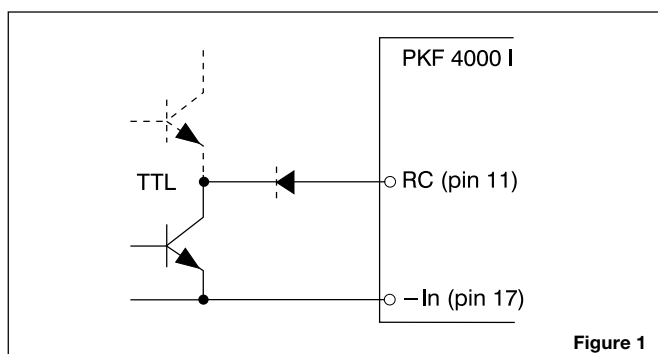

Figure 1

## Over Voltage Protection (OVP)

The remote control can be utilized also for OVP by using the external circuitry in figure 2. Resistor values are for 5 V output applications, but can easily be adjusted for other output voltages and the desired OVP level.

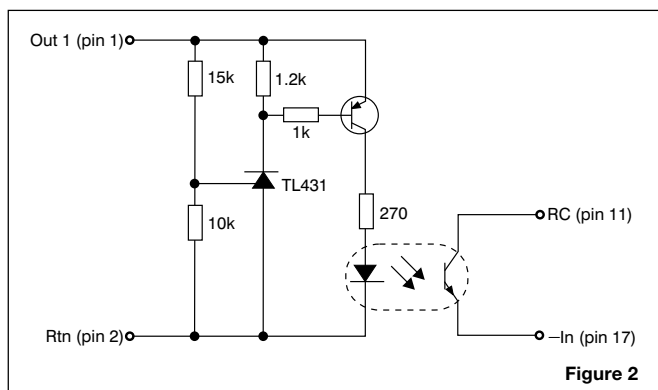

Figure 2

## Turn-on/off Input Voltage

The power module monitors the input voltage and will turn on and turn off at predetermined levels set by means of external resistors.

To increase  $V_{Ion}$  a resistor should be connected between pin 11 and 17 (see fig. 3).

The resistance is given by the following equation (For  $V_{Ion} > 37$  V):

$$R_{Ion} = 100 \times (100.2 - V_{Ion}) / (V_{Ion} - 36.5) \text{ k}\Omega$$

where 36.5 is the typical unadjusted turn-on input voltage (V).  $V_{Ioff}$  is the adjusted turn-off input voltage and is determined by  $V_{Ion} - V_{Ioff} = 2$  V (typical value).

To decrease  $V_{Ion}$  a resistor should be connected between pin 10 and 11 (see fig. 3). The resistance is given by the following equation (for  $30 \text{ V} < V_{Ion} < 36 \text{ V}$ ):

$$R_{Ion} = 364 \times (V_{Ion} - 29.9) / (36.5 - V_{Ion}) \text{ k}\Omega$$

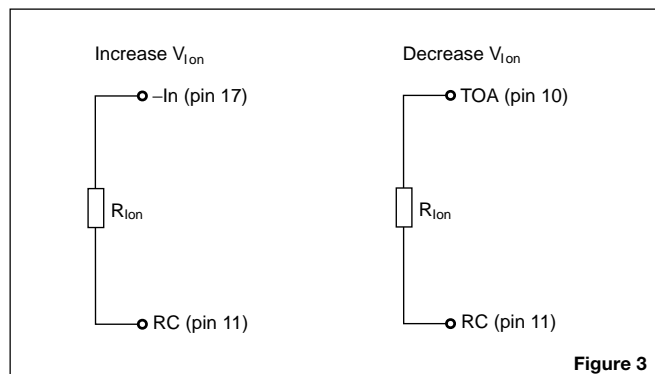

Figure 3

## Output Voltage Adjust ( $V_{adj}$ )

Output voltage,  $V_O$ , can be adjusted by using an external resistor. Typical adjust range is  $\pm 15\%$ . If pins 8 and 9 are not connected together the output will decrease to a low value. To increase  $V_O$  a resistor should be connected between pin 8/9 and 18, and to decrease  $V_O$  a resistor should be connected between pin 8 and 9 (see fig. 4).

Typical required resistor value to increase  $V_O$  is given by:

$$R_{adj} = k_1 \times (k_2 - V_O) / (V_O - V_{O_i}) \text{ k}\Omega$$

where  $V_O$  is the desired output voltage,  
 $V_{O_i}$  is the typical output voltage initial setting

and	$k_1=0.684$	$k_2= 2.46 \text{ V}$	PKF 4310
	$k_1=0.495$	$k_2= 3.93 \text{ V}$	PKF 4510
	$k_1=0.495$	$k_2= 5.87 \text{ V}$	PKF 4611
	$k_1=0.566$	$k_2=15.00 \text{ V}$	PKF 4621*)
	$k_1=0.495$	$k_2= 5.87 \text{ V}$	PKF 4622
	$k_1=0.495$	$k_2= 3.93 \text{ V}$	PKF 4628
	$k_1=0.495$	$k_2= 5.87 \text{ V}$	PKF 4629
	$k_1=0.566$	$k_2=15.00 \text{ V}$	PKF 4713*)

Typical required resistor value to decrease  $V_O$  is given by:

$$R_{adj} = k_1 \times (V_{O_i} - V_O) / (V_O - k_2) \text{ k}\Omega$$

where	$k_1=2.751$	$k_2=1.75 \text{ V}$	PKF 4310
	$k_1=1.986$	$k_2=2.59 \text{ V}$	PKF 4510
	$k_1=1.986$	$k_2=4.12 \text{ V}$	PKF 4611
	$k_1=2.284$	$k_2=9.52 \text{ V}$	PKF 4621
	$k_1=1.986$	$k_2=4.12 \text{ V}$	PKF 4622
	$k_1=1.986$	$k_2=2.59 \text{ V}$	PKF 4628
	$k_1=1.986$	$k_2=4.12 \text{ V}$	PKF 4629
	$k_1=2.284$	$k_2=9.52 \text{ V}$	PKF 4713

\*) Over 13.8 V output voltage, the input voltage range is limited to 38...65 V.

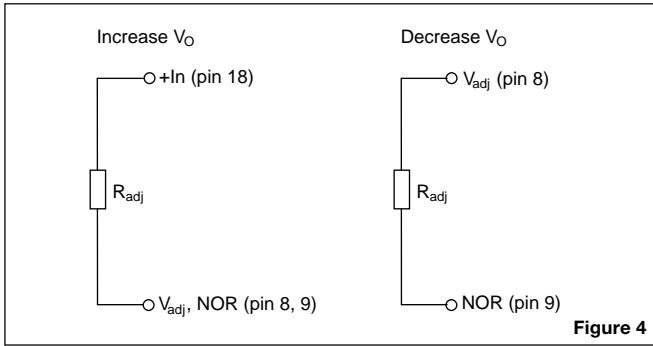

Figure 4

### Voltage Margin

For voltage controlled margining e.g. at final test, the following setup can be used. By increasing the control voltage V1 to +10 V the output voltage decreases 5% of  $V_{O1}$ , and by decreasing V1 to -10 V the output voltage increases 5%.

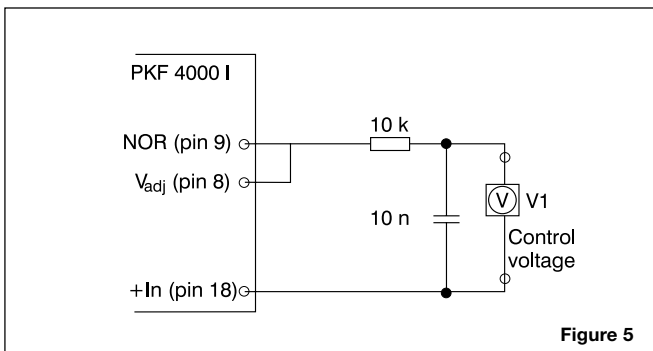

Figure 5

### Capacitive Load

The PKF series has no maximum limit for capacitive load on the output. The power module may operate in current limiting mode during start-up, affecting the ramp-up and the start-up time. For optimum start performance we recommend maximum 100  $\mu\text{F}/\text{A}$  of  $I_O$ . Connect capacitors at the point of load for best performance.

### Parallel Operation

Paralleling of several converters is easily accomplished by direct connection of the output voltage terminal pins. The load regulation characteristic is specifically designed for optimal paralleling performance. Load sharing between converters will be within  $\pm 10\%$ . It is recommended not to exceed  $P_O = n \times 0.9 \times P_{O\text{max}}$ , where  $P_{O\text{max}}$  is the maximum converter output power and  $n$  the number of paralleled converters, to prevent overloading any of the converters and thereby decreasing the reliability performance.

### Current Limiting Protection ( $I_{lim}$ )

The output power is limited at loads above the output current limiting threshold ( $I_{lim}$ ), specified as a minimum value.

### Input and Output Impedance

Both the source impedance of the power feeding and the load impedance will interact with the impedance of the DC/DC power module. It is most important to have the ratio between  $L$  and  $C$  as low as possible, i.e. a low characteristic impedance, both at the input and output, as the power modules have a low energy storage capability.

Use an electrolytic capacitor across the input or output if the source or load inductance is larger than 10  $\mu\text{H}$ . Their equivalent series resistance together with the capacitance acts as a lossless damping filter. Suitable capacitor values are in the range of 10–100  $\mu\text{F}$ . Tantalum capacitors are not recommended due to their low ESR-value.

## Delivery Package Information

### Tubes

The PKF-series is delivered in tubes (designated by /A) with a length of 500 mm (19.69 in), see fig. 6.

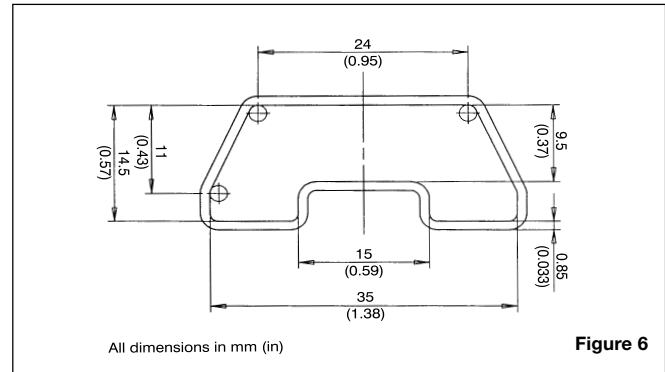

Figure 6

### Specification

Material:	Antistatic coated PVC
Max surface resistance:	$10^{11} \Omega/\square$
Color:	Transparent
Capacity:	10 power modules/tube
Weight:	Typ. 60 g
End stops:	Pins

### Trays

SMD versions, SI, can be delivered in standard JEDEC trays (designated by /B) on request, see fig. 7. For more information, please contact your local Ericsson sales office.

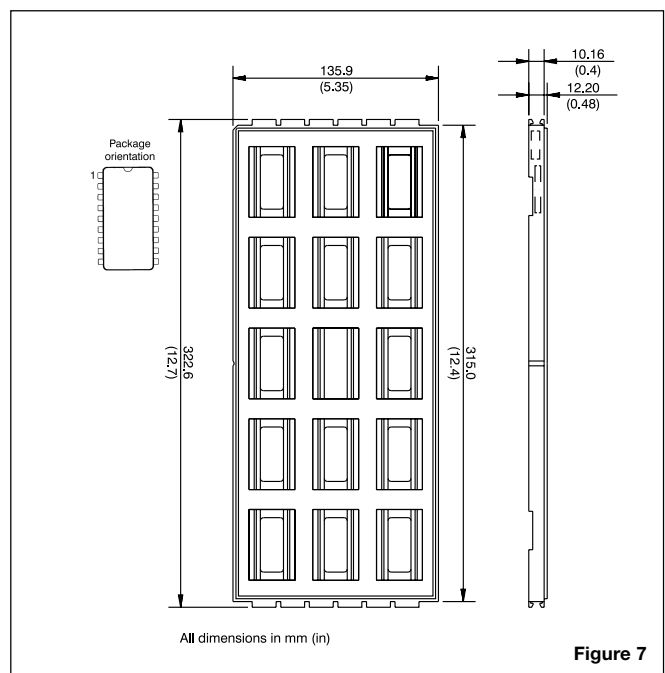

Figure 7

## Specification

Material:	Polypropylene (PP)
Max temperature:	125 °C
Max surface resistance:	10 <sup>5</sup> Ω/□
Color:	Black
Capacity:	15 power modules/tray
Stacking pitch:	10.16 mm
Weight:	Typ. 130 g
Min. order quantity:	150 pcs (one box contains 10 full trays)

## Tape & Reel

SMD versions, SI, can be delivered in standard tape & reel package (designated by /C) on request, see fig. 8. For more information, please contact your local Ericsson sales office.

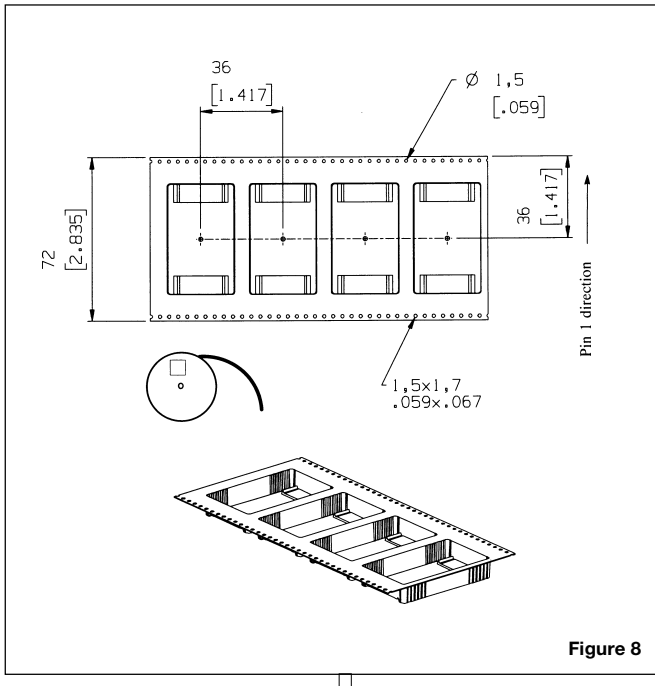

## Specification

Tape material:	Conductive polystyrene (PS)
Tape width:	72 mm
Tape pitch:	36 mm
Max surface resistance:	10 <sup>5</sup> Ω/□
Tape color:	Black
Cover tape color:	Transparent
Reel diameter:	13"
Reel hub diameter:	7"
Reel capacity:	150 power modules/reel
Full reel weight:	Typ. 3.7 kg
Min. order quantity:	300 pcs (one box contains two reels)

## Quality

### Reliability

Meantime between failure (MTBF) is calculated to >4.9 million hours at full output power and a pin temperature of +50 °C (T<sub>A</sub> = +40 °C), using the Ericsson failure rate data system. The Ericsson failure rate data system is based on field failure rates and is continuously updated. The data corresponds to actual failure rates of components used in Information Technology and Telecom equipment in temperature controlled environments (T<sub>A</sub> = -5...+65 °C). The data is considered to have a confidence level of 90%. For more information see Design Note 002.

### Quality Statement

The products are designed and manufactured in an industrial environment where quality systems and methods like ISO 9000, 6σ and SPC are intensively in use to boost the continuous improvements strategy. Infant mortality or early failures in the products are screened out by a burn-in procedure and an ATE-based final test. Conservative design rules, design reviews and product qualifications, as well as high competence of an engaged work force, contribute to the high quality of our products.

### Warranty

Ericsson Microelectronics warrants to the original purchaser or end user that the products conform to this Data Sheet and are free from material and workmanship defects for a period of five (5) years from the date of manufacture, if the product is used within specified conditions and not opened. In case the product is discontinued, claims will be accepted up to three (3) years from the date of the discontinuation.

For additional details on this limited warranty we refer to Ericsson Microelectronics AB's "General Terms and Conditions of Sales", or individual contract documents.

### Limitation of liability

Ericsson Microelectronics does not make any other warranties, expressed or implied including any warranty of merchantability or fitness for a particular purpose (including, but not limited to, use in life support applications, where malfunctions of product can cause injury to a person's health or life).

Information given in this data sheet is believed to be accurate and reliable. No responsibility is assumed for the consequences of its use nor for any infringement of patents or other rights of third parties which may result from its use. No license is granted by implication or otherwise under any patent or patent rights of Ericsson Microelectronics. These products are sold only according to Ericsson Microelectronics' general conditions of sale, unless otherwise confirmed in writing. Specifications subject to change without notice.





## Product Program

V <sub>I</sub>	V <sub>O</sub> /I <sub>O</sub> max		P <sub>O</sub> max	Ordering No. <sup>1)</sup>	
	Output 1	Output 2		Through-hole	SMD
48/60 V	2.1 V/1.5 A		3 W	PKF 4310 PI	PKF 4310 SI
	3.3 V/1.5 A		5 W	PKF 4510 PI	PKF 4510 SI
	5 V/1.2 A		6 W	PKF 4611 PI	PKF 4611 SI
	12 V/0.6 A <sup>1)</sup>		7 W	PKF 4713 PI	PKF 4713 SI
	+12 V/0.5 A <sup>1)</sup>	-12 V/0.5 A	6 W	PKF 4621 PI	PKF 4621 SI
	+5 V/1.0 A	-5 V/1.0 A	6 W	PKF 4622 PI	PKF 4622 SI
	+5 V/1.0 A	+3.3 V/1.0 A	6 W	PKF 4628 PI	PKF 4628 SI
	+5 V/1.2 A	-12 V/0.5 A	7 W	PKF 4629 PI <sup>2)</sup>	PKF 4629 SI

1) Adjustable to 15V, 2) On request.

<sup>1)</sup> See also Delivery Package Information

Ericsson Microelectronics AB  
 SE-164 81 KISTA, Sweden  
 Phone: +46 8 757 5000  
[www.ericsson.com/microelectronics](http://www.ericsson.com/microelectronics)

For local sales contacts, please refer to our website  
 or call: Int. +46 8 757 4700, Fax: +46 8 757 4776

The latest and most complete information can be found on our website!

Data Sheet

EN/LZT 146 33 R1A (Replaces EN/LZT 137 09 R7)  
 © Ericsson Microelectronics AB, June 2000