

FEATURES

- Software Programmable Features:
 - Unipolar/Bipolar Conversions
 - 4 Differential/8 Single Ended Inputs
 - MSB or LSB First Data Sequence
 - Variable Data Word Length
- Built-In Sample and Hold
- Single Supply 5V, 10V or $\pm 5V$ Operation
- Direct 4 Wire Interface to Most MPU Serial Ports and All MPU Parallel Ports
- 30kHz Maximum Throughput Rate

KEY SPECIFICATIONS

- Resolution: 10 Bits
- Total Unadjusted Error (LTC1090A): $\pm 1/2$ LSB Max
- Conversion Time: 22 μ s
- Supply Current: 2.5mA Max, 1.0mA Typ

 LTC and LT are registered trademarks of Linear Technology Corporation. LTCMOS is a trademark of Linear Technology Corp.

DESCRIPTION

The LTC[®]1090 is a data acquisition component which contains a serial I/O successive approximation A/D converter. It uses LTCMOS[™] switched capacitor technology to perform either 10-bit unipolar, or 9-bit plus sign bipolar A/D conversions. The 8-channel input multiplexer can be configured for either single ended or differential inputs (or combinations thereof). An on-chip sample and hold is included for all single ended input channels.

The serial I/O is designed to be compatible with industry standard full duplex serial interfaces. It allows either MSB or LSB first data and automatically provides 2's complement output coding in the bipolar mode. The output data word can be programmed for a length of 8, 10, 12 or 16 bits. This allows easy interface to shift registers and a variety of processors.

The LTC1090A is specified with total unadjusted error (including the effects of offset, linearity and gain errors) less than ± 0.5 LSB.

The LTC1090 is specified with offset and linearity less than ± 0.5 LSB but with a gain error limit of ± 2 LSB for applications where gain is adjustable or less critical.

TYPICAL APPLICATION

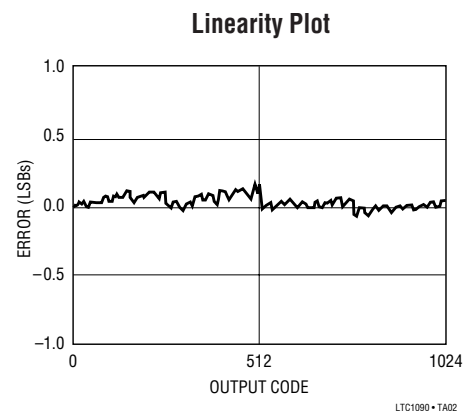
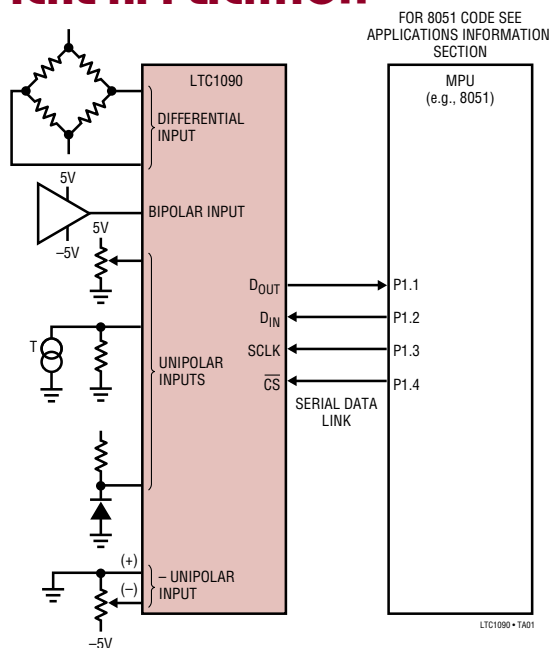

ABSOLUTE MAXIMUM RATINGS

(Notes 1 and 2)

Supply Voltage (V_{CC}) to GND or V^-	12V
Negative Supply Voltage (V^-)	-6V to GND
Voltage:	
Analog and Reference	
Inputs	(V^-) -0.3V to V_{CC} 0.3V
Digital Inputs	-0.3V to 12V
Digital Outputs	-0.3V to V_{CC} 0.3V
Power Dissipation	500mW
Operating Temperature Range	
LTC1090AC/LTC1090C	-40°C to 85°C
LTC1090AM/LTC1090M (OBSOLETE)	-55°C to 125°C
Storage Temperature Range	-65°C to 150°C
Lead Temperature (Soldering, 10 sec)	300°C

PACKAGE/ORDER INFORMATION

TOP VIEW		ORDER PART NUMBER
CH0	1	LTC1090ACN LTC1090CN LTC1090CSW
CH1	2	
CH2	3	
CH3	4	
CH4	5	
CH5	6	
CH6	7	
CH7	8	
COM	9	
DGND	10	
	20	V_{CC}
	19	ACLK
	18	SCLK
	17	D_{IN}
	16	D_{OUT}
	15	\overline{CS}
	14	REF+
	13	REF-
	12	V^-
	11	AGND
SW PACKAGE 20-LEAD PLASTIC SO WIDE		LTC1090AMJ LTC1090MJ LTC1090ACJ LTC1090CJ
N PACKAGE 20-LEAD PDIP		
$T_{JMAX} = 150^\circ\text{C}$, $\theta_{JA} = 70^\circ\text{C/W}$		
$T_{JMAX} = 110^\circ\text{C}$, $\theta_{JA} = 90^\circ\text{C/W}$		
J PACKAGE 20-LEAD CERDIP		
$T_{JMAX} = 150^\circ\text{C}$, $\theta_{JA} = 70^\circ\text{C/W}$		
OBSOLETE PACKAGE		
Consider the SW or N Package for Alternate Source		

Consult LTC Marketing for parts specified with wider operating temperature ranges.

RECOMMENDED OPERATING CONDITIONS

SYMBOL	PARAMETER	CONDITIONS	LTC1090/LTC1090A		UNITS
			MIN	MAX	
V_{CC}	Positive Supply Voltage	$V^- = 0\text{V}$	4.5	10	V
V^-	Negative Supply Voltage	$V_{CC} = 5\text{V}$	-5.5	0	V
f_{SCLK}	Shift Clock Frequency	$V_{CC} = 5\text{V}$	0	1.0	MHz
f_{ACLK}	A/D Clock Frequency	$V_{CC} = 5\text{V}$	0.01	2.0	MHz
		25°C	0.05	2.0	
		85°C	0.25	2.0	
		125°C			
t_{CYC}	Total Cycle Time	See Operating Sequence	10 SCLK + 48 ACLK		Cycles
$t_{h\overline{CS}}$	Hold Time, \overline{CS} Low After Last SCLK↓	$V_{CC} = 5\text{V}$	0		ns
t_{hDI}	Hold Time, D_{IN} After SCLK↑	$V_{CC} = 5\text{V}$	150		ns
$t_{su\overline{CS}}$	Setup Time \overline{CS} ↓ Before Clocking in First Address Bit (Note 9)	$V_{CC} = 5\text{V}$	2 ACLK Cycles 1μs		
t_{suDI}	Setup Time, D_{IN} Stable Before SCLK↑	$V_{CC} = 5\text{V}$	400		ns
t_{WHACKL}	ACLK High Time	$V_{CC} = 5\text{V}$	127		ns
t_{WLACKL}	ACLK Low Time	$V_{CC} = 5\text{V}$	200		ns
$t_{WH\overline{CS}}$	\overline{CS} High Time During Conversion	$V_{CC} = 5\text{V}$	44		ACLK Cycles

CONVERTER AND MULTIPLEXER CHARACTERISTICS

The ● denotes specifications which apply over the full operating temperature range, otherwise specifications are $T_A = 25^\circ\text{C}$. (Note 3)

PARAMETER	CONDITIONS		LTC1090A			LTC1090			UNITS
			MIN	TYP	MAX	MIN	TYP	MAX	
Offset Error	(Note 4)	●			±0.5			±0.5	LSB
Linearity Error	(Notes 4 and 5)	●			±0.5			±0.5	LSB
Gain Error	(Note 4)	●			±1.0			±2.0	LSB
Total Unadjusted Error	$V_{REF} = 5.000\text{V}$ (Notes 4 and 6)	●			±1.0				LSB
Reference Input Resistance				10			10		k Ω
Analog and REF Input Range	(Note 7)			$(V^-) - 0.05\text{V to } V_{CC} 0.05\text{V}$					V
On Channel Leakage Current (Note 8)	On Channel = 5V Off Channel = 0V	●			1			1	μA
	On Channel = 0V Off Channel = 5V	●			-1			-1	μA
Off Channel Leakage Current (Note 8)	On Channel = 5V Off Channel = 0V	●			-1			-1	μA
	On Channel = 0V Off Channel = 5V	●			1			1	μA

AC ELECTRICAL CHARACTERISTICS

The ● denotes specifications which apply over the full operating temperature range, otherwise specification are $T_A = 25^\circ\text{C}$. (Note 3)

SYMBOL	PARAMETER	CONDITIONS		LTC1090/LTC1090A			UNITS
				MIN	TYP	MAX	
t_{ACC}	Delay Time From CS \downarrow to D _{OUT} Data Valid	(Note 9)			2		ACLK Cycles
t_{SMPL}	Analog Input Sample Time	See Operating Sequence			5		SCLK Cycles
t_{CONV}	Conversion Time	See Operating Sequence			44		ACLK Cycles
t_{dDO}	Delay Time, SCLK \downarrow to D _{OUT} Data Valid	See Test Circuits	●		250	450	ns
t_{dis}	Delay Time, $\overline{\text{CS}}\uparrow$ to D _{OUT} Hi-Z	See Test Circuits	●	140	300	ns	ns
t_{en}	Delay Time, 2nd CLK \downarrow to D _{OUT} Enabled	See Test Circuits	●	150	400	ns	ns
t_{hDO}	Time Output Data Remains Valid After SCLK \downarrow				50		ns
t_f	D _{OUT} Fall Time	See Test Circuits	●	90	300	ns	ns
t_r	D _{OUT} Rise Time	See Test Circuits	●	60	300	ns	ns
C_{IN}	Input Capacitance	Analog Inputs	On Channel		65		pF
			Off Channel		5		pF
		Digital Inputs			5		pF

DIGITAL AND DC ELECTRICAL CHARACTERISTICS

The ● denotes specifications which apply over the full operating temperature range, otherwise specification are $T_A = 25^\circ\text{C}$. (Note 3)

SYMBOL	PARAMETER	CONDITIONS	LTC1090/LTC1090A			UNITS
			MIN	TYP	MAX	
V_{IH}	High Level Input Voltage	$V_{CC} = 5.25\text{V}$	●	2.0		V
V_{IL}	Low Level Input Voltage	$V_{CC} = 4.75\text{V}$	●		0.8	V
I_{IH}	High Level Input Current	$V_{IN} = V_{CC}$	●		2.5	μA
I_{IL}	Low Level Input Current	$V_{IN} = 0\text{V}$	●		-2.5	μA
V_{OH}	High Level Output Voltage	$V_{CC} = 4.75\text{V}, I_O = 10\mu\text{A}$ $V_{CC} = 4.75\text{V}, I_O = 360\mu\text{A}$	●	2.4	4.7 4.0	V V
V_{OL}	Low Level Output Voltage	$V_{CC} = 4.75\text{V}, I_O = 1.6\text{mA}$	●		0.4	V
I_{OZ}	Hi-Z Output Leakage	$V_{OUT} = V_{CC}, \overline{\text{CS}} \text{ High}$ $V_{OUT} = 0\text{V}, \overline{\text{CS}} \text{ High}$	● ●		3 -3	μA μA
I_{SOURCE}	Output Source Current	$V_{OUT} = 0\text{V}$			-10	mA
I_{SINK}	Output Sink Current	$V_{OUT} = V_{CC}$			10	mA
I_{CC}	Positive Supply Current	$\overline{\text{CS}} \text{ High}, \text{REF}^+ \text{ Open}$	●		1.0	2.5 mA
I_{REF}	Reference Current	$V_{REF} = 5\text{V}$	●		0.5	1.0 mA
I^-	Negative Supply Current	$\overline{\text{CS}} \text{ High}, V^- = -5\text{V}$	●		1	50 μA

Note 1: Absolute Maximum Ratings are those values beyond which the life of a device may be impaired.

Note 2: All voltage values are with respect to ground with DGND, AGND and REF^- wired together (unless otherwise noted).

Note 3: $V_{CC} = 5\text{V}$, $V_{REF+} = 5\text{V}$, $V_{REF-} = 0\text{V}$, $V^- = 0\text{V}$ for unipolar mode and -5V for bipolar mode, $\text{ACLK} = 2.0\text{MHz}$, $\text{SCLK} = 0.5\text{MHz}$ unless otherwise specified.

Note 4: These specs apply for both unipolar and bipolar modes. In bipolar mode, one LSB is equal to the bipolar input span ($2V_{REF}$) divided by 1024. For example, when $V_{REF} = 5\text{V}$, $1\text{LSB (bipolar)} = 2(5\text{V})/1024 = 9.77\text{mV}$.

Note 5: Linearity error is specified between the actual end points of the A/D transfer curve.

Note 6: Total unadjusted error includes offset, gain, linearity, multiplexer and hold step errors.

Note 7: Two on-chip diodes are tied to each reference and analog input which will conduct for reference or analog input voltages one diode drop

below V^- or one diode drop above V_{CC} . Be careful during testing at low V_{CC} levels (4.5V), as high level reference or analog inputs (5V) can cause this input diode to conduct, especially at elevated temperatures, and cause errors for inputs near full-scale. This spec allows 50mV forward bias of either diode. This means that as long as the reference or analog input does not exceed the supply voltage by more than 50mV, the output code will be correct. To achieve an absolute 0V to 5V input voltage range will therefore require a minimum supply voltage of 4.950V over initial tolerance, temperature variations and loading.

Note 8: Channel leakage current is measured after the channel selection.

Note 9: To minimize errors caused by noise at the chip select input, the internal circuitry waits for two ACLK falling edges after a chip select falling edge is detected before responding to control input signals. Therefore, no attempt should be made to clock an address in or data out until the minimum chip select setup time has elapsed.

TEST CIRCUITS

On and Off Channel Leakage Current

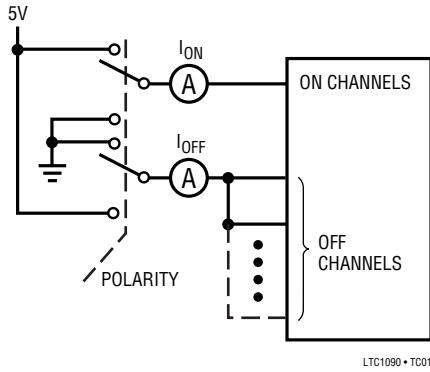

Voltage Waveforms for D_{OUT} Delay Time, t_{dDO}

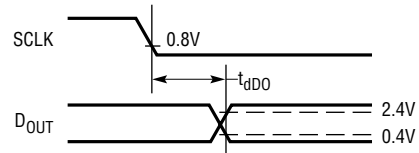

Voltage Waveforms for D_{OUT} Rise and Fall Times, t_r, t_f

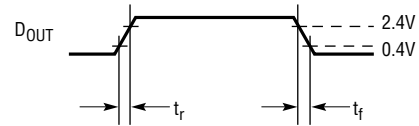

LTC1090 • TC02

Voltage Waveforms for t_{en} and t_{dis}

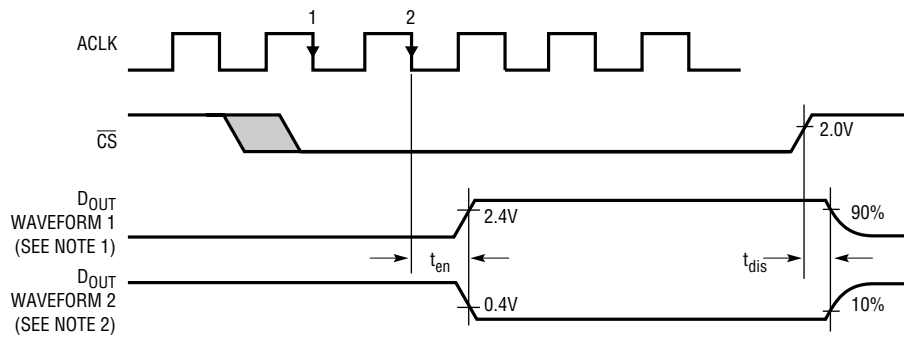

NOTE 1: WAVEFORM 1 IS FOR AN OUTPUT WITH INTERNAL CONDITIONS SUCH THAT THE OUTPUT IS HIGH UNLESS DISABLED BY THE OUTPUT CONTROL

NOTE 2: WAVEFORM 2 IS FOR AN OUTPUT WITH INTERNAL CONDITIONS SUCH THAT THE OUTPUT IS LOW UNLESS DISABLED BY THE OUTPUT CONTROL

LTC1090 • TC03

Load Circuit for t_{dis} and t_{en}

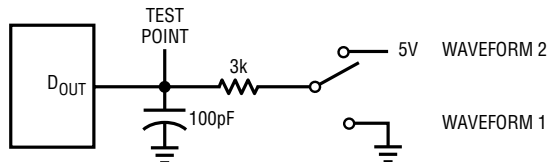

LTC1090 • TC04

Load Circuit for t_{dDO}, t_r, and t_f

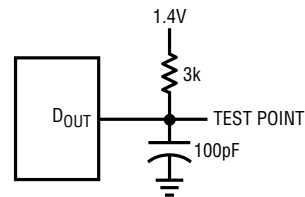

LTC1090 • TC05

PIN FUNCTIONS

#	PIN	FUNCTION	DESCRIPTION
1-8 9	CH0 to CH7 COM	Analog Inputs Common	The analog inputs must be free of noise with respect to AGND. The common pin defines the zero reference point for all single ended inputs. It must be free of noise and is usually tied to the analog ground plane.
10	DGND	Digital Ground	This is the ground for the internal logic. Tie to the ground plane.
11	AGND	Analog Ground	AGND should be tied directly to the analog ground plane.
12	V ⁻	Negative Supply	Tie V ⁻ to most negative potential in the circuit. (Ground in single supply applications.)
13,14	REF ⁻ , REF ⁺	Reference Inputs	The reference inputs must be kept free of noise with respect to AGND.
15	CS	Chip Select Input	A logic low on this input enables data transfer.
16	D _{OUT}	Digital Data Output	The A/D conversion result is shifted out of this output.
17	D _{IN}	Data Input	The A/D configuration word is shifted into this input.
18	SCLK	Shift Clock	This clock synchronizes the serial data transfer.
19	ACLK	A/D Conversion Clock	This clock controls the A/D conversion process.
20	V _{CC}	Positive Supply	This supply must be kept free of noise and ripple by bypassing directly to the analog ground plane.

BLOCK DIAGRAM

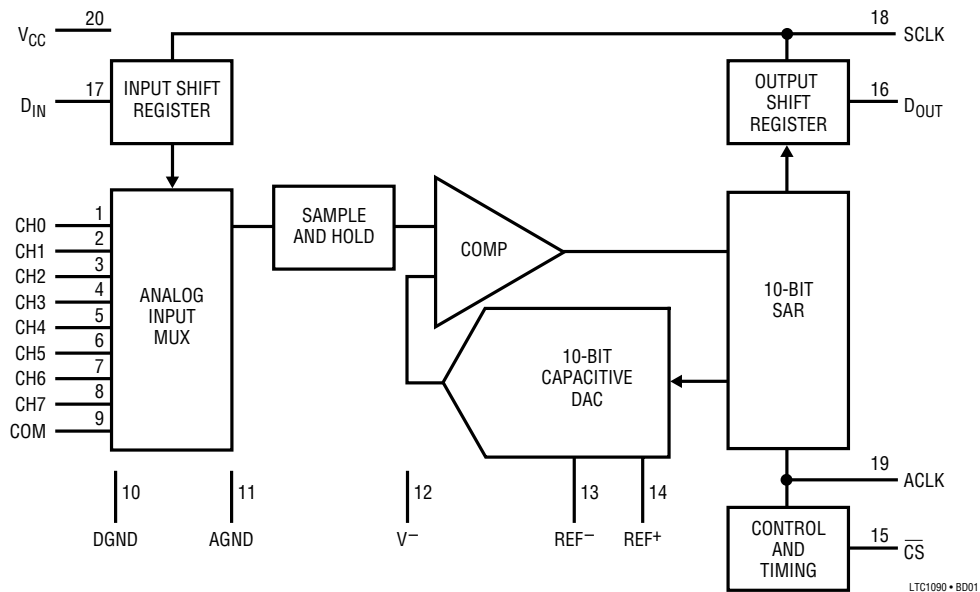

TYPICAL PERFORMANCE CHARACTERISTICS

Supply Current vs Supply Voltage

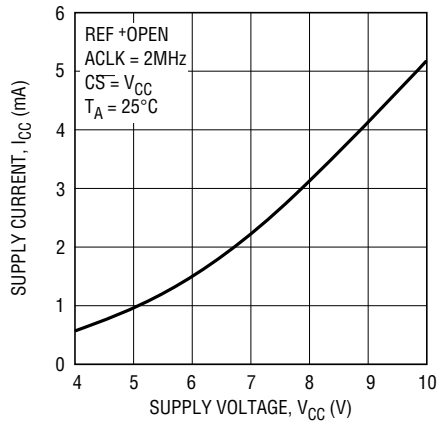

LTC1090 • TPC01

Supply Current vs Temperature

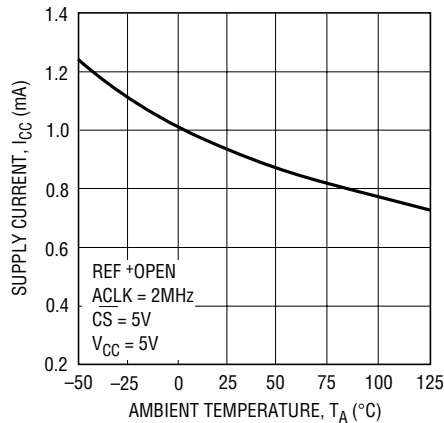

LTC1090 • TPC02

Reference Current vs Temperature

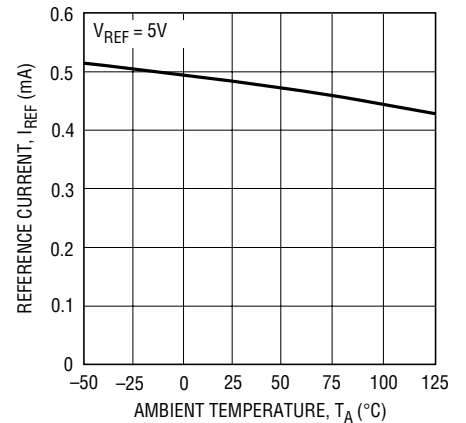

LTC1090 • TPC03

Unadjusted Offset Error vs Reference Voltage

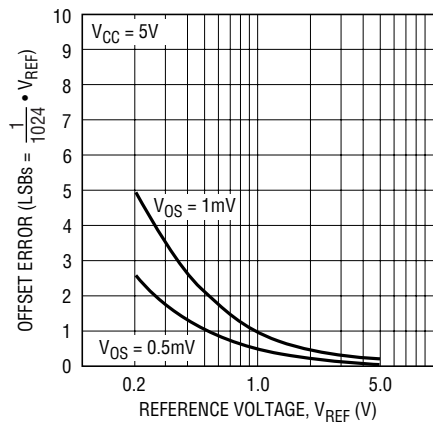

LTC1090 • TPC04

Linearity Error vs Reference Voltage

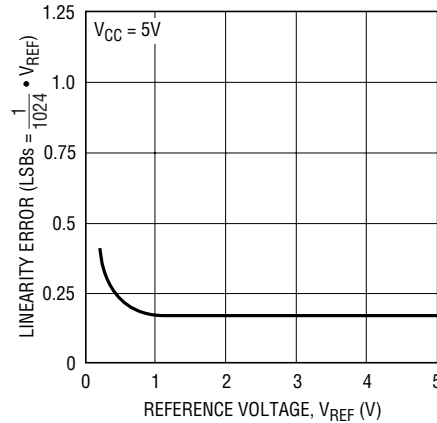

LTC1090 • TPC05

Change in Gain Error vs Reference Voltage

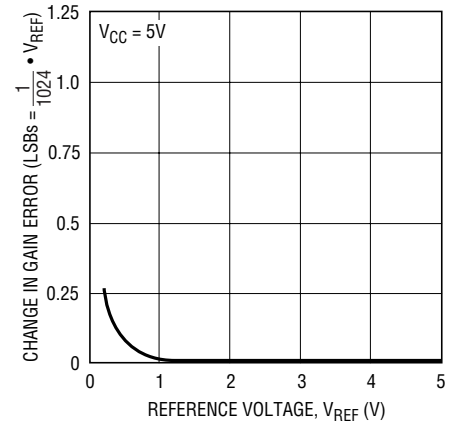

LTC1090 • TPC06

Offset Error vs Supply Voltage

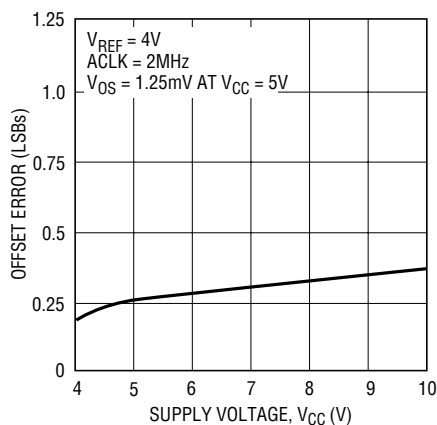

LTC1090 • TPC07

Linearity Error vs Supply Voltage

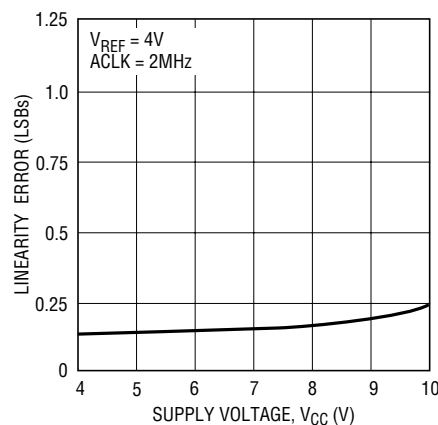

LTC1090 • TPC08

Change in Gain Error vs Supply Voltage

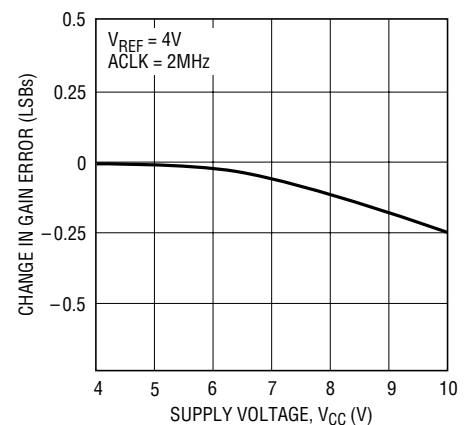

LTC1090 • TPC09

TYPICAL PERFORMANCE CHARACTERISTICS

Change in Offset Error vs Temperature

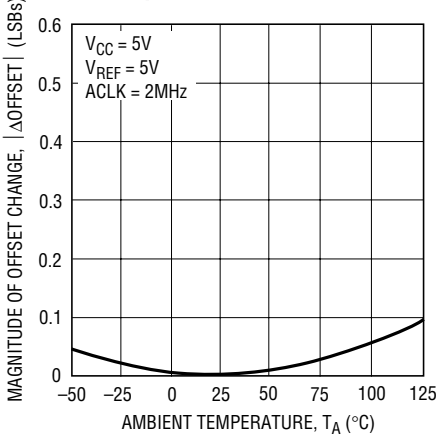

LTC1090 • TPC10

Change in Linearity Error vs Temperature

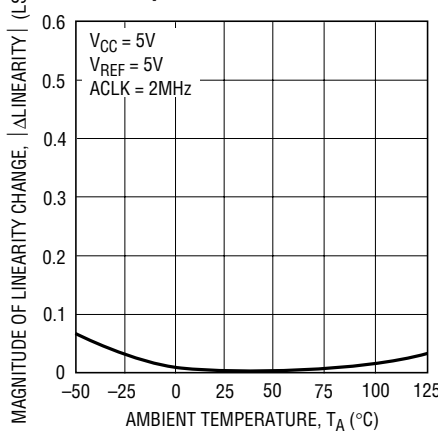

LTC1090 • TPC11

Change in Gain Error vs Temperature

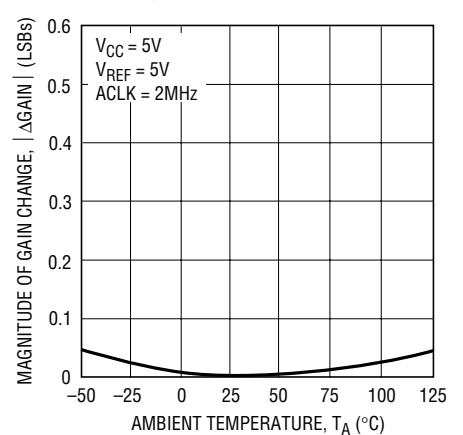

LTC1090 • TPC12

Maximum Conversion Clock Rate vs Temperature

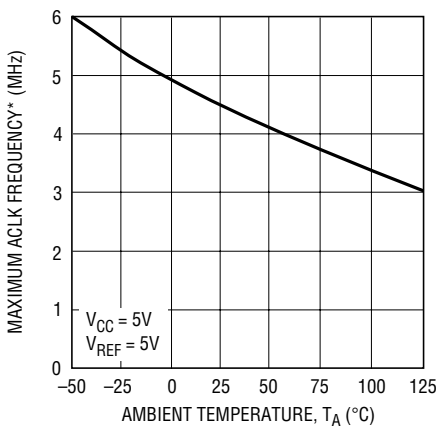

LTC1090 • TPC13

Maximum Conversion Clock Rate vs Reference Voltage

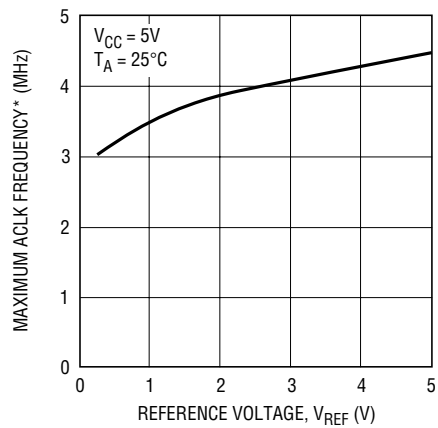

LTC1090 • TPC14

Maximum Conversion Clock Rate vs Supply Voltage

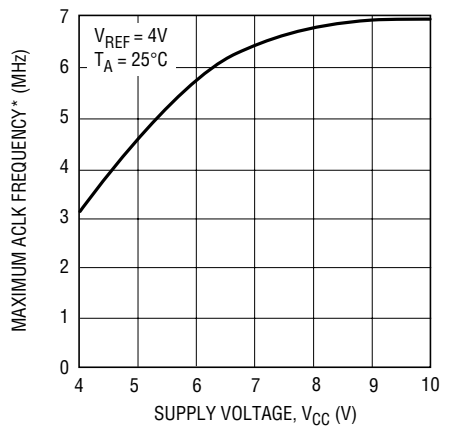

LTC1090 • TPC15

Maximum Conversion Clock Rate vs Source Resistance

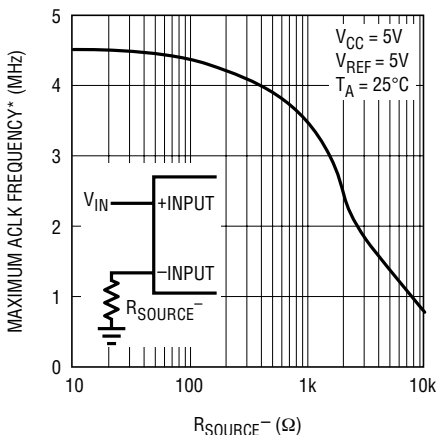

LTC1090 • TPC16

Maximum Filter Resistor vs Cycle Time

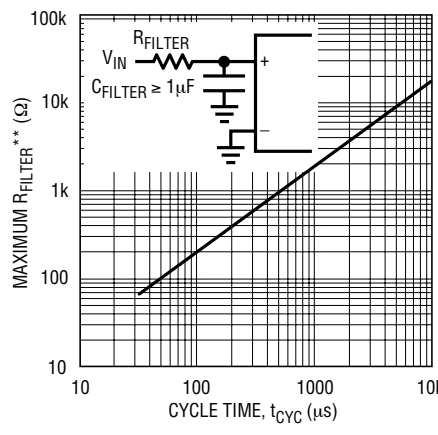

LTC1090 • TPC17

Sample-and-Hold Acquisition Time vs Source Resistance

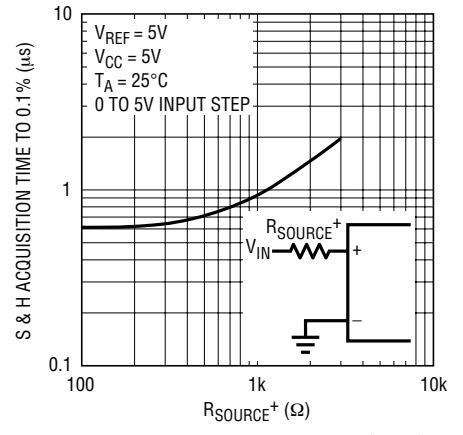

LTC1090 • TPC18

*MAXIMUM ACLK FREQUENCY REPRESENTS THE ACLK FREQUENCY AT WHICH A 0.1LSB SHIFT IN THE ERROR AT ANY CODE TRANSITION FROM ITS 2MHz VALUE IS FIRST DETECTED.

**MAXIMUM R_{FILTER} REPRESENTS THE FILTER RESISTOR VALUE AT WHICH A 0.1LSB SHIFT CHANGE IN FULL SCALE ERROR FROM ITS VALUE AT R_{FILTER} = 0 IS FIRST DETECTED.

TYPICAL PERFORMANCE CHARACTERISTICS

Digital Input Logic Threshold vs Supply Voltage

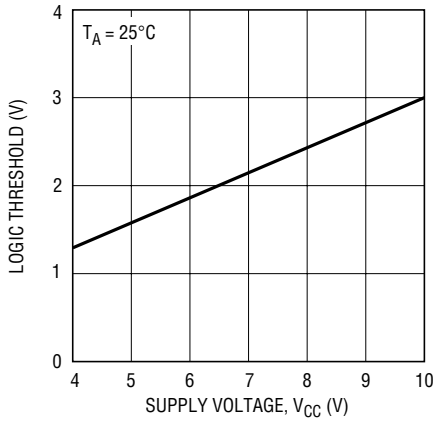

LTC1090 • TPC19

Input Channel Leakage Current vs Temperature

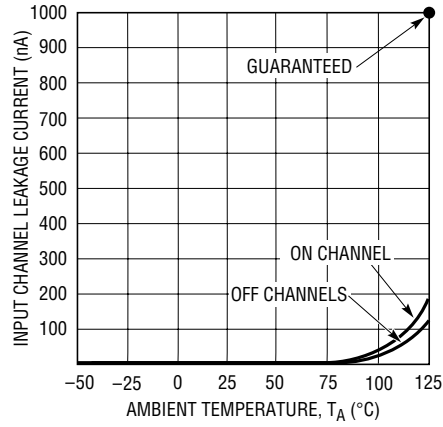

LTC1090 • TPC20

Noise Error vs Reference Voltage

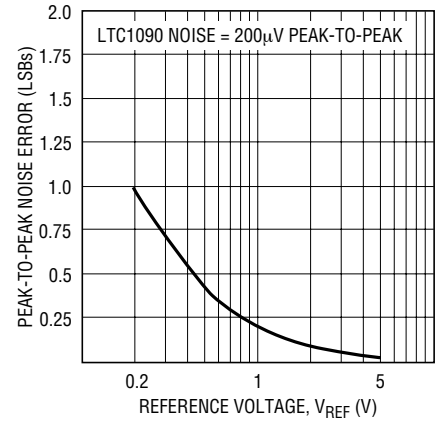

LTC1090 • TPC21

APPLICATIONS INFORMATION

The LTC1090 is a data acquisition component which contains the following functional blocks:

1. 10-bit successive approximation capacitive A/D converter
2. Analog multiplexer (MUX)
3. Sample and hold (S/H)
4. Synchronous, full duplex serial interface
5. Control and timing logic

DIGITAL CONSIDERATIONS

1. Serial Interface

The LTC1090 communicates with microprocessors and other external circuitry via a synchronous, full duplex, four wire serial interface (see Operating Sequence). The shift clock (SCLK) synchronizes the data transfer with each bit being transmitted on the falling SCLK edge and captured on the rising SCLK edge in both transmitting and receiving systems. The data is transmitted and received simultaneously (full duplex).

Operating Sequence
(Example: Differential Inputs (CH3 to CH2), Bipolar, MSB First and 10-Bit Word Length)

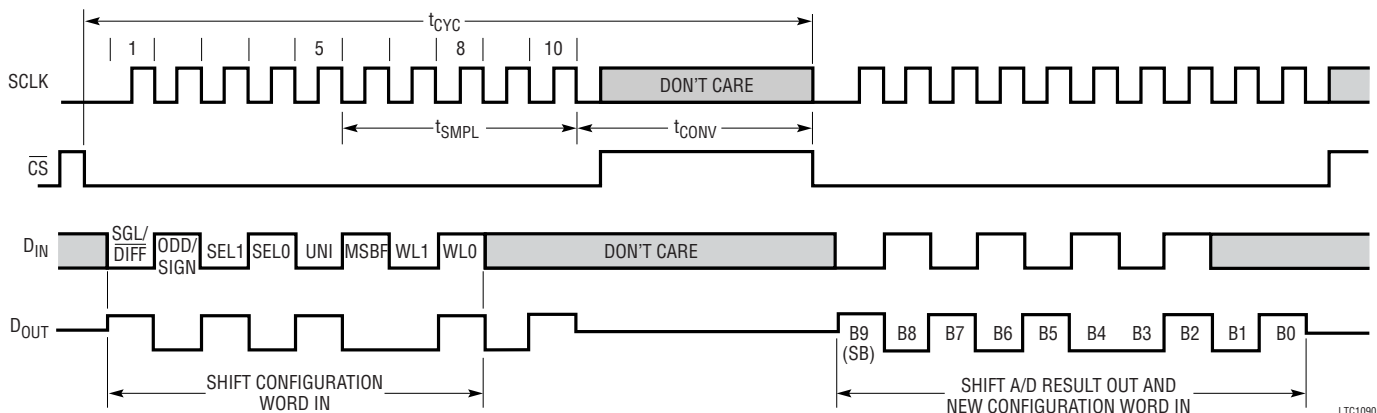

LTC1090 • A101

APPLICATIONS INFORMATION

Data transfer is initiated by a falling chip select (\overline{CS}) signal. After the falling \overline{CS} is recognized, an 8-bit input word is shifted into the D_{IN} input which configures the LTC1090 for the next conversion. Simultaneously, the result of the previous conversion is output on the D_{OUT} line. At the end of the data exchange the requested conversion begins and \overline{CS} should be brought high. After t_{CONV} , the conversion is complete and the results will be available on the next data transfer cycle. As shown below, the result of a conversion is delayed by one \overline{CS} cycle from the input word requesting it.

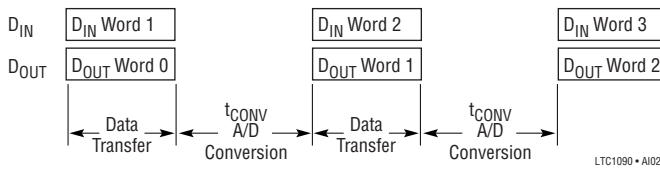

2. Input Data Word

The LTC1090 8-bit input data word is clocked into the D_{IN} input on the first eight rising SCLK edges after chip select is recognized. Further inputs on the D_{IN} pin are then ignored until the next \overline{CS} cycle. The eight bits of the input word are defined as follows:

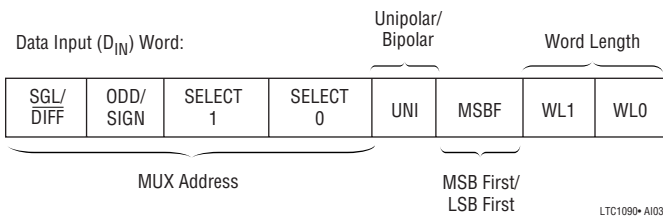

Multiplexer (MLIX) Address

The first four bits of the input word assign the MUX configuration for the requested conversion. For a given channel selection, the converter will measure the voltage between the two channels indicated by the + and – signs in the selected row of Table 1. Note that in differential mode ($SGL/DIFF = 0$) measurements are limited to four adjacent input pairs with either polarity. In single ended mode, all input channels are measured with respect to COM. Figure 1 shows some examples of multiplexer assignments.

Table 1. Multiplexer Channel Selection

MUX ADDRESS				DIFFERENTIAL CHANNEL SELECTION							
SGL/DIFF	ODD/SIGN	SELECT 1	SELECT 0	0	1	2	3	4	5	6	7
0	0	0	0	+	-						
0	0	0	1			+	-				
0	0	1	0					+	-		
0	0	1	1							+	-
0	1	0	0	-	+						
0	1	0	1			-	+				
0	1	1	0					-	+		
0	1	1	1							-	+

MUX ADDRESS				SINGLE ENDED CHANNEL SELECTION								
SGL/DIFF	ODD/SIGN	SELECT 1	SELECT 0	0	1	2	3	4	5	6	7	COM
1	0	0	0	+								-
1	0	0	1			+						-
1	0	1	0					+				-
1	0	1	1							+		-
1	1	0	0		+							-
1	1	0	1				+					-
1	1	1	0						+			-
1	1	1	1								+	-

APPLICATIONS INFORMATION

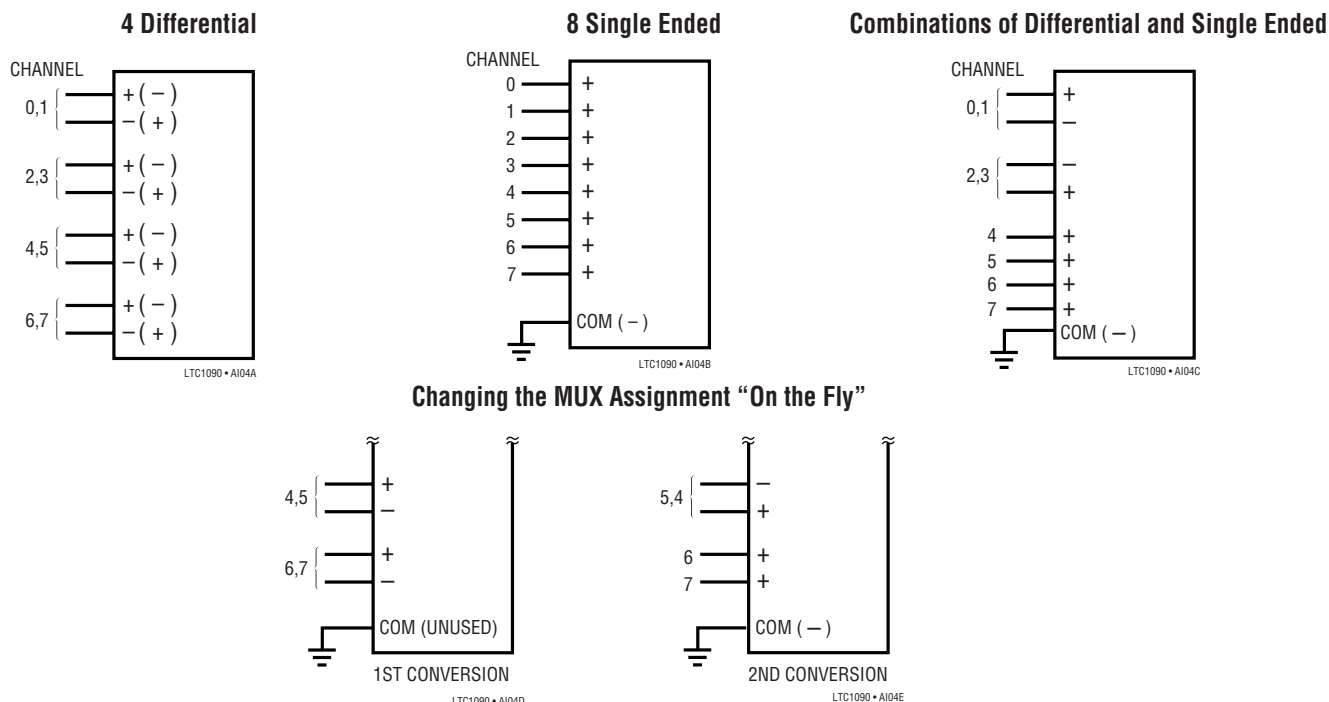
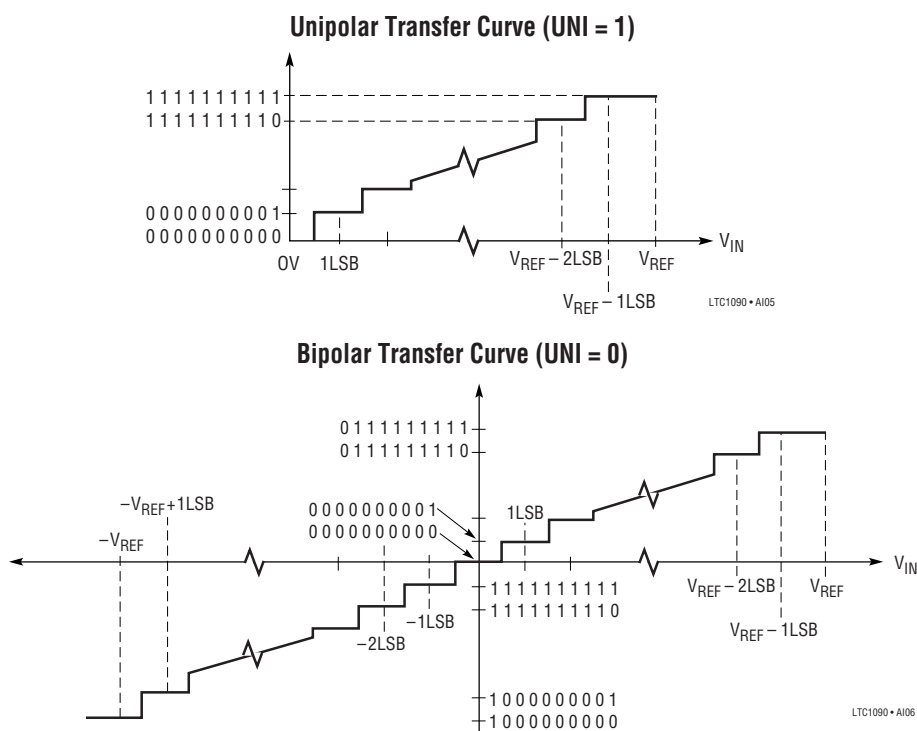

Figure 1. Examples of Multiplexer Options on the LTC1090

Unipolar/Bipolar (UNI)

The fifth input bit (UNI) determines whether the conversion will be unipolar or bipolar. When UNI is a logical one, a unipolar conversion will be performed on the selected

input voltage. When UNI is a logical zero, a bipolar conversion will result. The input span and code assignment for each conversion type are shown in the figures below.



APPLICATIONS INFORMATION

Unipolar Output Code (UNI = 1)

OUTPUT CODE	INPUT VOLTAGE	INPUT VOLTAGE (V _{REF} = 5V)
1111111111	V _{REF} - 1LSB	4.9951V
1111111110	V _{REF} - 2LSB	4.9902V
⋮	⋮	⋮
⋮	⋮	⋮
0000000001	1LSB	0.0049V
0000000000	0V	0V

Bipolar Output Code (UNI = 0)

OUTPUT CODE	INPUT VOLTAGE	INPUT VOLTAGE (V _{REF} = 5V)
0111111111	V _{REF} - 1LSB	4.9902V
0111111110	V _{REF} - 2LSB	4.9805V
⋮	⋮	⋮
⋮	⋮	⋮
0000000001	1LSB	0.0098V
0000000000	0V	0V
1111111111	-1LSB	-0.0098V
1111111110	-2LSB	-0.0195V
⋮	⋮	⋮
⋮	⋮	⋮
1000000001	-(V _{REF}) + 1LSB	-4.9902V
1000000000	-(V _{REF})	-5.000V

MSB First/LSB First Format (MSBF)

The output data of the LTC1090 is programmed for MSB first or LSB first sequence using the MSBF bit. For MSB first output data the input word clocked to the LTC1090 should always contain a logical one in the sixth bit location (MSBF bit). Likewise for LSB first output data, the input word clocked to the LTC1090 should always contain a zero in the MSBF bit location. The MSBF bit in a given D_{IN} word will control the order of the next D_{OUT} word. The MSBF bit affects only the order of the output data word. The order of the input word is unaffected by this bit.

MSBF	OUTPUT FORMAT
0	LSB First
1	MSB First

Word Length (WL1, WL0)

The last two bits of the input word (WL1 and WL0) program the output data word length of the LTC1090. Word lengths of 8, 10, 12 or 16 bits can be selected according to the following table. The WL1 and WL0 bits in a given D_{IN} word

control the length of the present, not the next, D_{OUT} word. **WL1 and WL0 are never “don’t cares”** and must be set for the correct D_{OUT} word length even when a “dummy” D_{IN} word is sent. On any transfer cycle, the word length should be made equal to the number of SCLK cycles sent by the MPU.

WL1	WL0	OUTPUT WORD LENGTH
0	0	8 Bits
0	1	10 Bits
1	0	12 Bits
1	1	16 Bits

Figure 2 shows how the data output (D_{OUT}) timing can be controlled with word length selection and MSB/LSB first format selection.

3. Deglitcher

A deglitching circuit has been added to the Chip Select input of the LTC1090 to minimize the effects of errors caused by noise on that input. This circuit ignores changes in state on the CS input that are shorter in duration than 1 ACLK cycle. After a change of state on the CS input, the LTC1090 waits for two falling edges of the ACLK before recognizing a valid chip select. One indication of CS low recognition is the D_{OUT} line becoming active (leaving the Hi-Z state). Note that the deglitching applies to both the rising and falling CS edges.

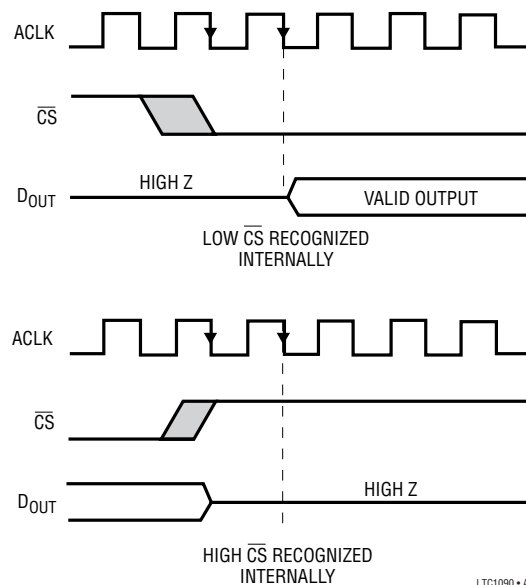

LTC1090 • A107

1090fc

APPLICATIONS INFORMATION

8-Bit Word Length

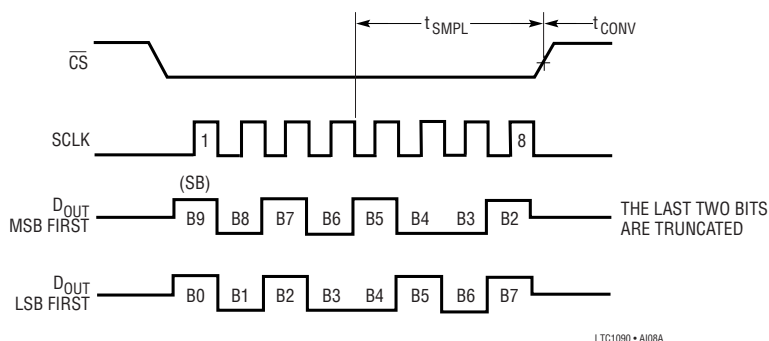

LTC1090 • AI08A

10-Bit Word Length

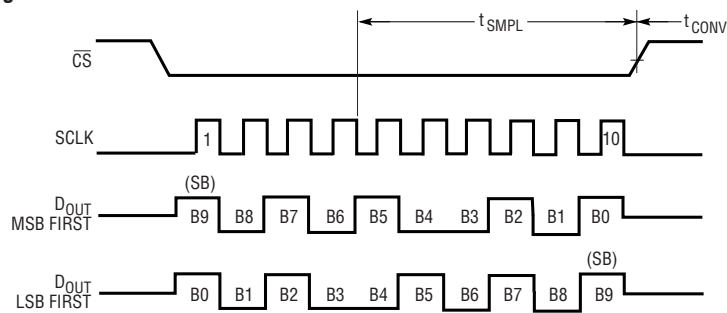

LTC1090 • AI08B

12-Bit Word Length

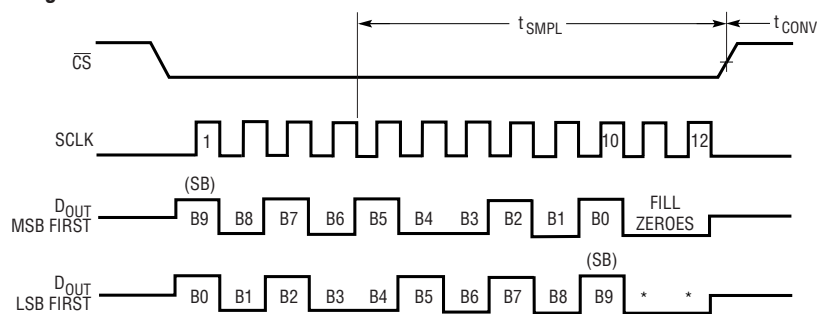

LTC1090 • AI08C

16-Bit Word Length

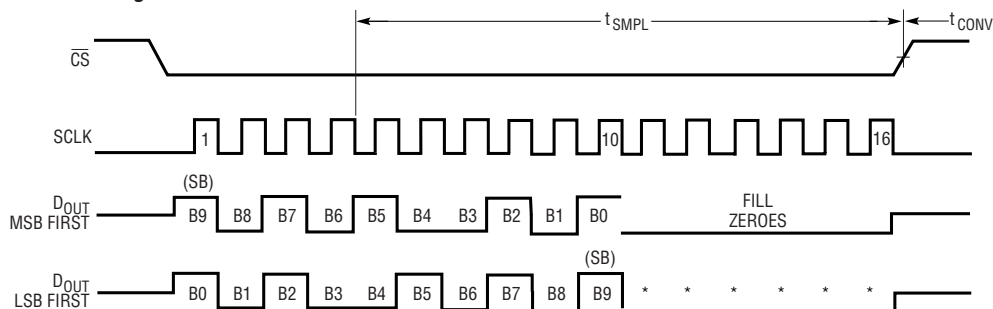

* IN UNIPOLAR MODE, THESE BITS ARE FILLED WITH ZEROES.
 IN BIPOLAR MODE, THE SIGN BIT IS EXTENDED INTO THESE LOCATIONS

LTC1090 • AI08D

Figure 2. Data Output (D_{OUT}) Timing with Different Word Lengths

APPLICATIONS INFORMATION

4. \overline{CS} Low During Conversion

In the normal mode of operation, \overline{CS} is brought high during the conversion time (see Figure 3). The serial port ignores any SCLK activity while \overline{CS} is high. The LTC1090 will also operate with \overline{CS} low during the conversion. In this mode, SCLK must remain low during the conversion as shown in Figure 4. After the conversion is complete, the

D_{OUT} line will become active with the first output bit. Then the data transfer can begin as normal.

5. Microprocessor Interfaces

The LTC1090 can interface directly (without external hardware) to most popular microprocessor (MPU) synchronous

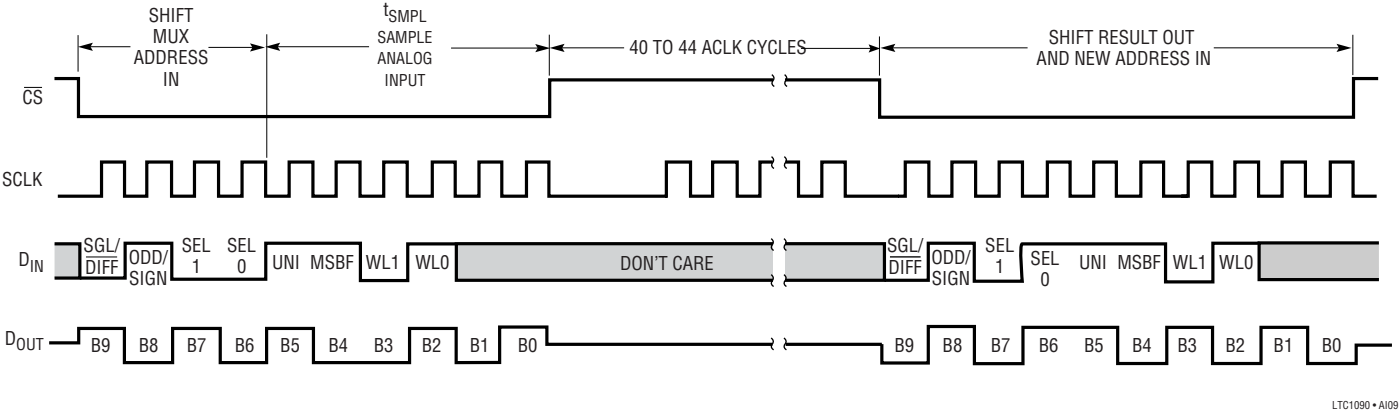

Figure 3. \overline{CS} High During Conversion

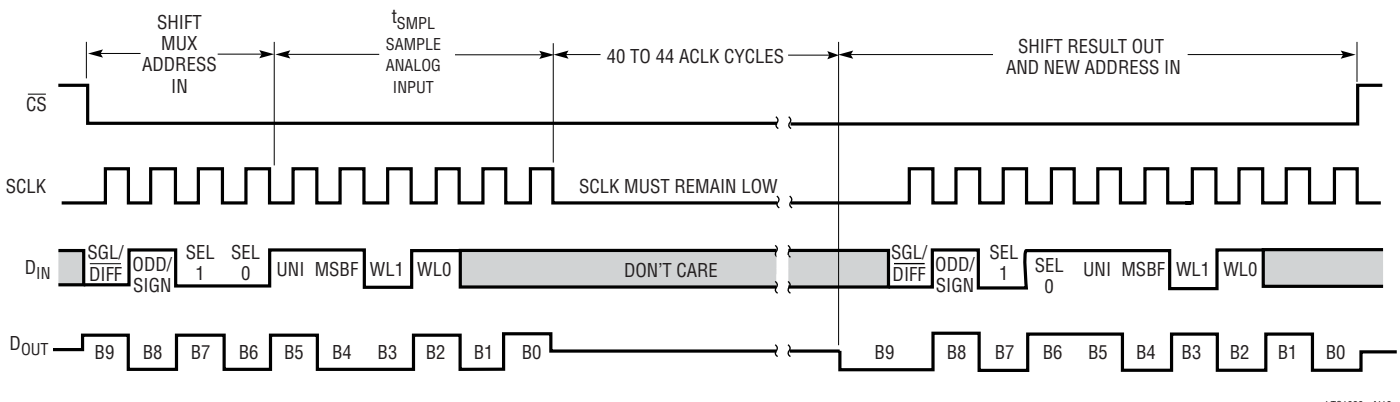

Figure 4. \overline{CS} Low During Conversion

APPLICATIONS INFORMATION

serial formats (see Table 2). If an MPU without a serial interface is used, then 4 of the MPU's parallel port lines can be programmed to form the serial link to the LTC1090. Included here are three serial interface examples and one example showing a parallel port programmed to form the serial interface.

Table 2. Microprocessors with Hardware Serial Interfaces Compatible with the LTC1090**

PART NUMBER	TYPE OF INTERFACE
Motorola	
MC6805S2, S3	SPI
MC68HC11	SPI
MC68HC05	SPI
RCA	
CDP68HC05	SPI
Hitachi	
HD6305	SCI Synchronous
HD63705	SCI Synchronous
HD6301	SCI Synchronous
HD63701	SCI Synchronous
HD6303	SCI Synchronous
National Semiconductor	
COP400 Family	MICROWIRE†
COP800 Family	MICROWIRE/PLUS†
NS8050U	MICROWIRE/PLUS
HPC16000 Family	MICROWIRE/PLUS
Texas Instruments	
TMS7002	Serial Port
TMS7042	Serial Port
TMS70C02	Serial Port
TMS70C42	Serial Port
TMS32011*	Serial Port
TMS32020*	Serial Port

*Requires external hardware

**Contact LTC Marketing for interface information for processors not on this list

†MICROWIRE and MICROWIRE/PLUS are trademarks of National Semiconductor Corp.

Serial Port Microprocessors

Most synchronous serial formats contain a shift clock (SCLK) and two data lines, one for transmitting and one for receiving. In most cases data bits are transmitted on the falling edge of the clock (SCLK) and captured on the rising edge. However, serial port formats vary among MPU manufacturers as to the smallest number of bits that can be sent in one group (e.g., 4-bit, 8-bit or 16-bit transfers). They also vary as to the order in which the bits are transmitted (LSB or MSB first). The following examples show how the LTC1090 accommodates these differences.

National MICROWIRE (COP420)

The COP420 transfers data MSB first and in 4-bit increments (nibbles). This is easily accommodated by setting the LTC1090 to MSB first format and 12-bit word length. The data output word is then received by the COP420 in three 4-bit blocks with the final two unused bits filled with zeroes by the LTC1090.

Hardware and Software Interface to National Semiconductor COP420 Processor

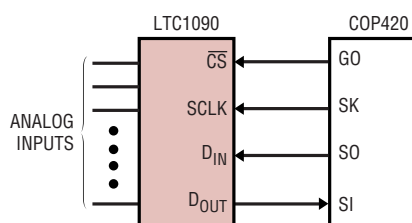

D_{OUT} from LTC1090 stored in COP420 RAM

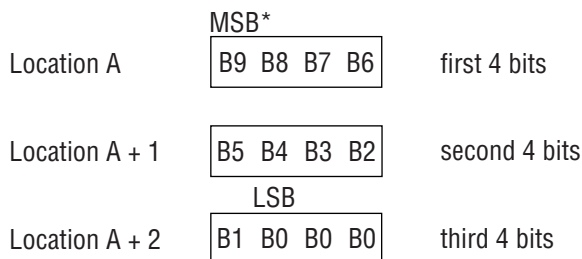

LTC1090 • A111

*B9 is MSB in unipolar or sign bit in bipolar

MNEMONIC	DESCRIPTION
LEI	Enable SIO
SC	Set Carry flag
OGI	GO is set to (CS goes low)
LDD	Load first 4 bits of D _{IN} to ACC
XAS	Swap ACC with SIO reg. Starts SK Clk
LDD	Load 2nd 4 bits of D _{IN} to ACC
NOP	Timing
XAS	Swap first 4 bits from A/D with ACC. SK continues.
XIS	Put first 4 bits in RAM (location A)
NOP	Timing
XAS	Swap 2nd 4 bits from A/D with ACC. SK continues.
XIS	Put 2nd 4 bits in RAM (location A + 1)
RC	Clear Carry
NOP	Timing
XAS	Swap 3rd 4 bits from A/D with ACC. SK off
XIS	Put 3rd 4 bits in RAM (location A + 2)
OGI	GO is set to 1 (CS goes high)
LEI	Disable SIO

1090fc

APPLICATIONS INFORMATION

Motorola SPI (MC68HC05C4)

The MC68HC05C4 transfers data MSB first and in 8-bit increments. Programming the LTC1090 for MSB first format and 16-bit word length allows the 10-bit data output to be received by the MPU as two 8-bit bytes with the final 6 unused bits filled with zeroes by the LTC1090.

Hardware and Software Interface to Motorola MC68HC05C4 Processor

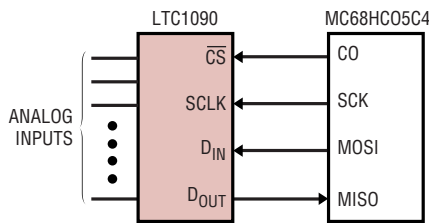

D_{OUT} from LTC1090 stored in MC68HC05C4 RAM

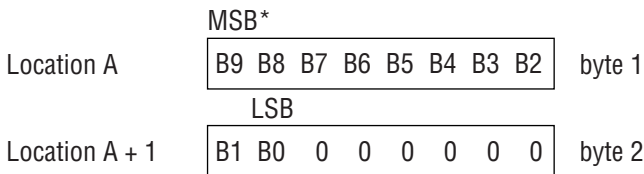

*B9 is MSB in unipolar or sign bit in bipolar

LTC1090 • A112

MNEMONIC	DESCRIPTION
BCLR n	C0 is cleared (\overline{CS} goes Low)
LDA	Load D _{IN} for LTC1090 into ACC
STA	Load D _{IN} from ACC to SPI data reg. Start SCK
↑	
NOP	8 NOPs for timing
↓	
LDA	Load contents of SPI status reg. into ACC
LDA	Load LTC1090 D _{OUT} from SPI data reg. into ACC (byte 1)
STA	Load LTC1090 D _{OUT} into RAM (location A)
STA	Start next SPI cycle
↑	
NOP	6 NOPs for timing
↓	
BSET n	C0 is set (\overline{CS} goes high)
LDA	Load contents of SPI status reg. into ACC
LDA	Load LTC1090 D _{OUT} from SPI data reg. into ACC (byte 2)
STA	Load LTC1090 D _{OUT} into RAM (location A + 1)

Hitachi Synchronous SCI (HD63705)

The HD63705 transfers serial data in 8-bit increments, LSB first. To accommodate this, the LTC1090 is programmed for 16-bit word length and LSB first format. The 10-bit output data is received by the processor as two 8-bit bytes, LSB first. The LTC1090 fills the final 6 unused bits (after the MSB) with zeroes in unipolar mode and with the sign bit in bipolar mode.

Hardware and Software Interface to Hitachi HD63705 Processor

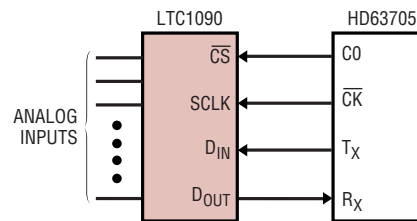

D_{OUT} from LTC1090 stored in HD63705 RAM

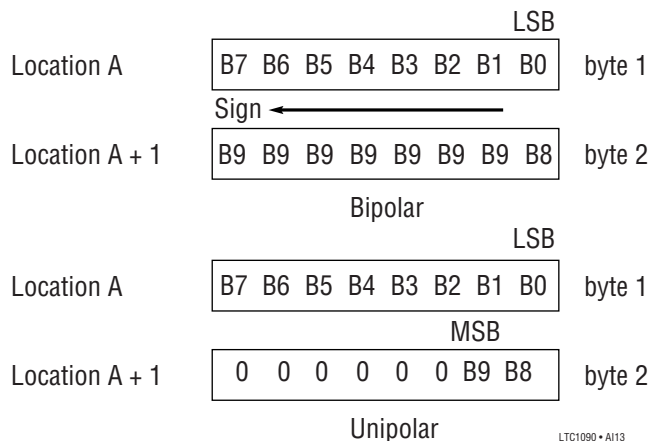

LTC1090 • A113

MNEMONIC	DESCRIPTION
LDA	Load D _{IN} word for LTC1090 into ACC from RAM
BCLR n	C0 cleared (\overline{CS} goes low)
STA	Load D _{IN} word for LTC1090 into SCI data reg. from ACC and start clocking data (LSB first)
↑	
NOP	6 NOPs for timing
↓	
LDA	Load contents of SCI data reg. into ACC (byte 1)
STA	Start next SCI cycle
STA	Load LTC1090 D _{OUT} word into RAM (Location A)
NOP	Timing
BSET n	C0 set (\overline{CS} goes high)
LDA	Load contents of SCI data reg. into ACC (byte 2)
STA	Load LTC1090 D _{OUT} word into RAM (Location A + 1)

1090fc

APPLICATIONS INFORMATION

Parallel Port Microprocessors

When interfacing the LTC1090 to an MPU which has a parallel port, the serial signals are created on the port with software. Three MPU port lines are programmed to create the \overline{CS} , SCLK and D_{IN} signals for the LTC1090. A fourth port line reads the D_{OUT} line. An example is made of the Intel 8051/8052/80C252 family.

Intel 8051

To interface to the 8051, the LTC1090 is programmed for MSB first format and 10-bit word length. The 8051 generates \overline{CS} , SCLK and D_{IN} on three port lines and reads D_{OUT} on the fourth.

Hardware and Software Interface to Intel 8051 Processor

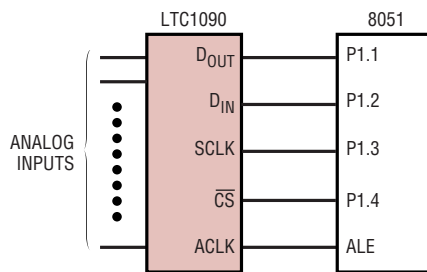

D_{OUT} from LTC1090 stored in 8051 RAM

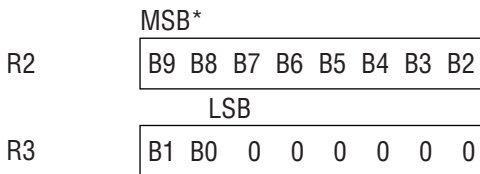

*B9 is MSB in unipolar or sign bit in bipolar

8051 Code

MNEMONIC	DESCRIPTION
MOV P1,#02H	Initialize port 1 (bit 1 is made an input)
CLR P1.3	SCLK goes low
SETB P1.4	\overline{CS} goes high
CONTINUE: MOV A,#0DH	D_{IN} word for the LTC1090 is placed in ACC.
	\overline{CS} goes low
	Load counter
	Delay for deglitcher
LOOP: MOV C, P1.1	Read data bit into carry
RLC A	Rotate data bit into ACC
MOV P1.2, C	Output D_{IN} bit to LTC1090
SETB P1.3	SCLK goes high
CLR P1.3	SCLK goes low
DJNZ R4, LOOP	Next bit
MOV R2, A	Store MSBs in R2
MOV C, P1.1	Read data bit into carry
CLR A	Clear ACC
RLC A	Rotate data bit into ACC
SETB P1.3	SCLK goes high
CLR P1.3	SCLK goes low
MOV C, P1.1	Read data bit into carry
RRC A	Rotate right into ACC
RRC A	Rotate right into ACC
MOV R3, A	Store LSBs in R3
SETB P1.3	SCLK goes high
CLR P1.3	SCLK goes low
SETB P1.4	\overline{CS} goes high
MOV R5,#07H	Load counter
DELAY: DJNZ R5, DELAY	Delay for LTC1090 to perform conversion
	Repeat program
AJMP CONTINUE	

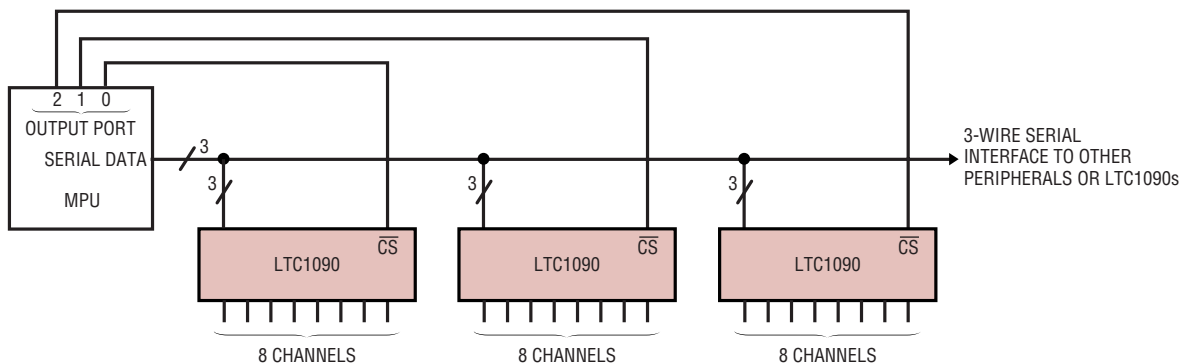

Figure 5. Several LTC1090's Sharing One 3-Wire Serial Interface

APPLICATIONS INFORMATION

6. Sharing the Serial Interface

The LTC1090 can share the same 3-wire serial interface with other peripheral components or other LTC1090s (see Figure 5). In this case, the CS signals decide which LTC1090 is being addressed by the MPU.

ANALOG CONSIDERATIONS

1. Grounding

The LTC1090 should be used with an analog ground plane and single point grounding techniques.

Pin 11 (AGND) should be tied directly to this ground plane.

Pin 10 (DGND) can also be tied directly to this ground plane because minimal digital noise is generated within the chip itself.

Pin 20 (V_{CC}) should be bypassed to the ground plane with a $4.7\mu\text{F}$ tantalum with leads as short as possible. Pin 12 (V^-) should be bypassed with a $0.1\mu\text{F}$ ceramic disk. For single supply applications, V^- can be tied to the ground plane.

It is also recommended that pin 13 (REF^-) and pin 9 (COM) be tied directly to the ground plane. All analog inputs should be referenced directly to the single point ground. Digital inputs and outputs should be shielded from and/or routed away from the reference and analog circuitry.

Figure 6 shows an example of an ideal ground plane design for a two sided board. Of course this much ground plane will not always be possible, but users should strive to get as close to this ideal as possible.

2. Bypassing

For good performance, V_{CC} must be free of noise and ripple. Any changes in the V_{CC} voltage with respect to analog ground during a conversion cycle can induce errors or noise in the output code. V_{CC} noise and ripple can be kept below 1mV by bypassing the V_{CC} pin directly to the analog ground plane with a $4.7\mu\text{F}$ tantalum with leads as short as possible. Figures 7 and 8 show the effects of good and poor V_{CC} bypassing.

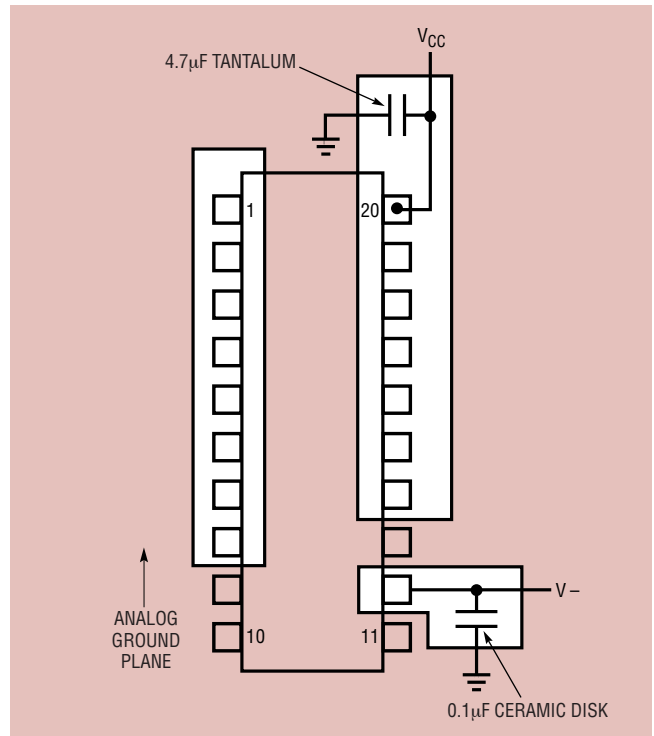

LTC1090 • AH15

Figure 6. Example Ground Plane for the LTC1090

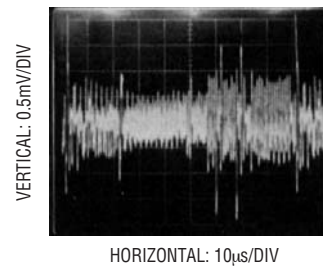

Figure 7. Poor V_{CC} Bypassing. Noise and Ripple can Cause A/D Errors

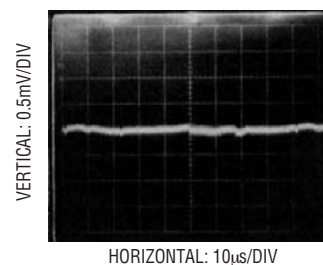

Figure 8. Good V_{CC} Bypassing Keeps Noise and Ripple on V_{CC} Below 1mV

APPLICATIONS INFORMATION

3. Analog Inputs

Because of the capacitive redistribution A/D conversion techniques used, the analog inputs of the LTC1090 have capacitive switching input current spikes. These current spikes settle quickly and do not cause a problem.

However, if large source resistances are used or if slow settling op amps drive the inputs, care must be taken to insure that the transients caused by the current spikes settle completely before the conversion begins.

Source Resistance

The analog inputs of the LTC1090 look like a 60pF capacitor (C_{IN}) in series with a 500Ω resistor (R_{ON}) as shown in Figure 9. C_{IN} gets switched between the selected “+” and “-” inputs once during each conversion cycle. Large external source resistors and capacitances will slow the settling of the inputs. It is important that the overall RC time constants be short enough to allow the analog inputs to completely settle within the allowed time.

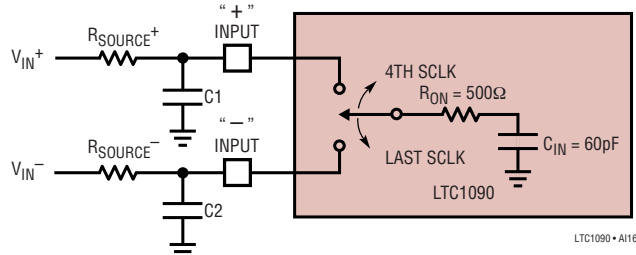

Figure 9. Analog Input Equivalent Circuit

“+” Input Settling

This input capacitor is switched onto the “+” input during the sample phase (t_{SMPL} , see Figure 10). The sample phase starts at the 4th SCLK cycle and lasts until the falling edge of the last SCLK (the 8th, 10th, 12th or 16th SCLK cycle depending on the selected word length). The voltage on the “+” input must settle completely within this sample time. Minimizing $R_{SOURCE+}$ and $C1$ will improve the input settling time. If large “+” input source resistance must be used, the sample time can be increased by using a slower SCLK frequency or selecting a longer word length. With the minimum possible sample time of 4μs, **$R_{SOURCE+} < 2k$ and $C1 < 20pF$ will provide adequate settling.**

“-” Input Settling

At the end of the sample phase the input capacitor switches to the “-” input and the conversion starts (see Figure 10). During the conversion, the “+” input voltage is effectively “held” by the sample and hold and will not affect the conversion result. However, it is critical that the “-” input voltage be free of noise and settle completely during the first four ACLK cycles of the conversion time. Minimizing $R_{SOURCE-}$ and $C2$ will improve settling time. If large “-” input source resistance must be used, the time allowed for settling can be extended by using a slower ACLK frequency. At the maximum ACLK rate of 2MHz, **$R_{SOURCE-} < 1k\Omega$ and $C2 < 20pF$ will provide adequate settling.**

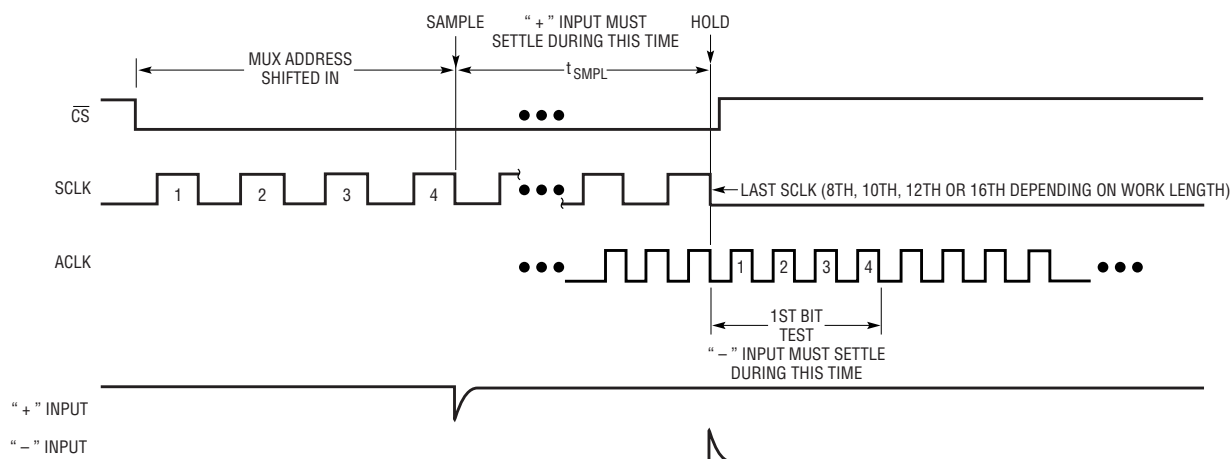

Figure 10. “+” and “-” Input Settling Windows

LTC1090 • A117

1090fc

APPLICATIONS INFORMATION

Input Op Amps

When driving the analog inputs with an op amp it is important that the op amp settle within the allowed time (see Figure 10). Again, the “+” and “-” input sampling times can be extended as described above to accommodate slower op amps. Most op amps including the LT1006 and LT1013 single supply op amps can be made to settle well even with the minimum settling windows of $4\mu\text{s}$ (“+” input) and $2\mu\text{s}$ (“-” input) which occur at the maximum clock rates (ACLK = 2MHz and SCLK = 1MHz). Figures 11 and 12 show examples of adequate and poor op amp settling.

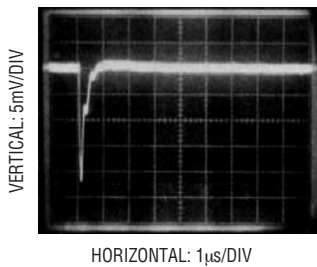

Figure 11. Adequate Settling of Op Amp Driving Analog Input

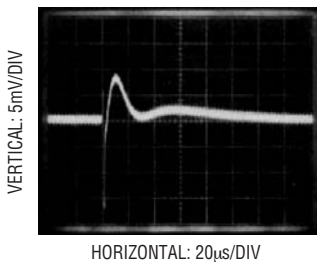

Figure 12. Poor Op Amp Settling can Cause A/D Errors

RC Input Filtering

It is possible to filter the inputs with an RC network as shown in Figure 13. For large values of C_F (e.g., $1\mu\text{F}$), the capacitive input switching currents are averaged into a net DC current. Therefore, a filter should be chosen with a small resistor and large capacitor to prevent DC drops across the resistor. The magnitude of the DC current is approximately $I_{DC} = 60\text{pF} \times V_{IN}/t_{CYC}$ and is roughly proportional to V_{IN} . When running at the minimum cycle time of $33\mu\text{s}$, the input current equals $9\mu\text{A}$ at $V_{IN} = 5\text{V}$. In this case, a filter resistor of 50Ω will cause 0.1LSB of full-scale error. If a larger filter resistor must be used, errors can be

eliminated by increasing the cycle time as shown in the typical curve of Maximum Filter Resistor vs Cycle Time.

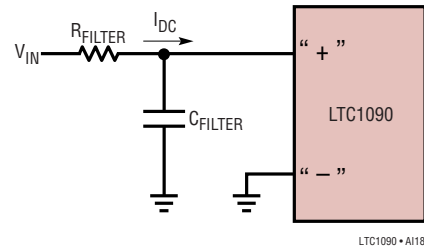

Figure 13. RC Input Filtering

Input Leakage Current

Input leakage currents can also create errors if the source resistance gets too large. For instance, the maximum input leakage specification of $1\mu\text{A}$ (at 125°C) flowing through a source resistance of $1\text{k}\Omega$ will cause a voltage drop of 1mV or 0.2LSB. This error will be much reduced at lower temperatures because leakage drops rapidly (see typical curve of Input Channel Leakage Current vs Temperature).

Noise Coupling into Inputs

High source resistance input signals ($>500\Omega$) are more sensitive to coupling from external sources. It is preferable to use channels near the center of the package (i.e., CH2 to CH7) for signals which have the highest output resistance because they are essentially shielded by the pins on the package ends (DGND and CH0). Grounding any unused inputs (especially the end pin, CH0) will also reduce outside coupling into high source resistances.

4. Sample-and-Hold

Single Ended Inputs

The LTC1090 provides a built-in sample and hold (S&H) function for all signals acquired in the single ended mode (COM pin grounded). This sample and hold allows the LTC1090 to convert rapidly varying signals (see typical curve of S&H Acquisition Time vs Source Resistance). The input voltage is sampled during the t_{SMPL} time as shown in Figure 10. The sampling interval begins after the fourth

APPLICATIONS INFORMATION

MUX address bit is shifted in and continues during the remainder of the data transfer. On the falling edge of the final SCLK, the S&H goes into hold mode and the conversion begins. The voltage will be held on either the 8th, 10th, 12th or 16th falling edge of the SCLK depending on the word length selected.

Differential Inputs

With differential inputs or when the COM pin is not tied to ground, the A/D no longer converts just a single voltage but rather the difference between two voltages. In these cases, the voltage on the selected “+” input is still sampled and held and therefore may be rapidly time varying just as in single ended mode. However, the voltage on the selected “-” input must remain constant and be free of noise and ripple throughout the conversion time. Otherwise, the differencing operation may not be performed accurately. The conversion time is 44 ACLK cycles. Therefore, a change in the “-” input voltage during this interval can “-” input this error would be:

$$V_{\text{ERROR (MAX)}} = V_{\text{PEAK}} \times 2 \times \pi \times f(\text{“-”}) \times 44/f_{\text{ACLK}}$$

Where $f(\text{“-”})$ is the frequency of the “-” input voltage, V_{PEAK} is its peak amplitude and f_{ACLK} is the frequency of the ACLK. In most cases V_{ERROR} will not be significant. For a 60Hz signal on the “-” input to generate a 1/4LSB error (1.25mV) with the converter running at $\text{ACLK} = 2\text{MHz}$, its peak value would have to be 150mV.

5. Reference Inputs

The voltage between the reference inputs of the LTC1090 defines the voltage span of the A/D converter. The reference inputs look primarily like a 10k Ω resistor but will have transient capacitive switching currents due to the switched capacitor conversion technique (see Figure 14). During each bit test of the conversion (every 4 ACLK cycles), a capacitive current spike will be generated on the reference pins by the A/D. These current spikes settle quickly and do not cause a problem. However, if slow settling circuitry is used to drive the reference inputs, care must be taken to insure that transients caused by these current spikes settle completely during each bit test of the conversion.

When driving the reference inputs, three things should be kept in mind:

1. The source resistance (R_{OUT}) driving the reference inputs should be low (less than 1 Ω) to prevent DC drops caused by the 1mA maximum reference current (I_{REF}).
2. Transients on the reference inputs caused by the capacitive switching currents must settle completely during each bit test (each 4 ACLK cycles). Figures 15 and 16 show examples of both adequate and poor settling. Using a slower ACLK will allow more time for the reference to settle. However, even at the maximum ACLK rate of 2MHz most references and op amps can be made to settle within the 2 μs bit time.
3. It is recommended that the REF^- input be tied directly to the analog ground plane. If REF^- is biased at a voltage other than ground, the voltage must not change during a conversion cycle. This voltage must also be free of noise and ripple with respect to analog ground.

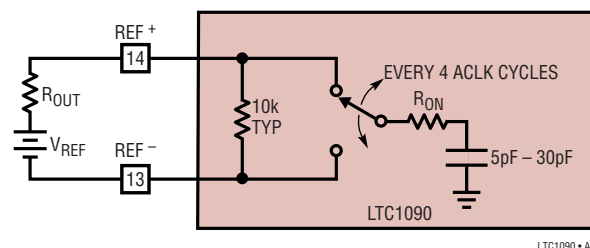

Figure 14. Reference Input Equivalent Circuit

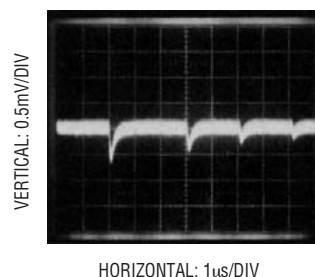

Figure 15. Adequate Reference Settling

APPLICATIONS INFORMATION

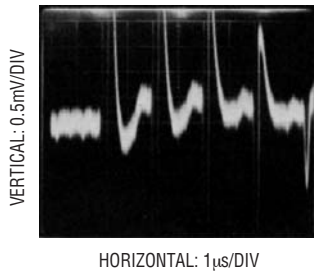

Figure 16. Poor Reference Settling Can Cause A/D Errors

6. Reduced Reference Operation

The effective resolution of the LTC1090 can be increased by reducing the input span of the converter. The LTC1090 exhibits good linearity and gain over a wide range of reference voltages (see typical curves of Linearity and Gain Error vs Reference Voltage). However, care must be taken when operating at low values of V_{REF} because of the reduced LSB step size and the resulting higher accuracy requirement placed on the converter. The following factors must be considered when operating at low V_{REF} values:

1. Conversion speed (ACLK frequency)
2. Offset
3. Noise

Conversion Speed with Reduced V_{REF}

With reduced reference voltages, the LSB step size is reduced and the LTC1090 internal comparator overdrive is reduced. With less overdrive, more time is required to perform a conversion. Therefore, the maximum ACLK frequency should be reduced when low values of V_{REF} are used. This is shown in the typical curve of Maximum Conversion Clock Rate vs Reference Voltage.

Offset with Reduced V_{REF}

The offset of the LTC1090 has a larger effect on the output code when the A/D is operated with reduced reference

voltage. The offset (which is typically a fixed voltage) becomes a larger fraction of an LSB as the size of the LSB is reduced. The typical curve of Unadjusted Offset Error vs Reference Voltage shows how offset in LSBs is related to reference voltage for a typical value of V_{OS} . For example, a V_{OS} of 0.5mV which is 0.1LSB with a 5V reference becomes 0.5LSB with a 1V reference and 2.5LSBs with a 0.2V reference. If this offset is unacceptable, it can be corrected digitally by the receiving system or by offsetting the “-” input to the LTC1090.

Noise with Reduced V_{REF}

The total input referred noise of the LTC1090 can be reduced to approximately 200 μ V peak-to-peak using a ground plane, good bypassing, good layout techniques and minimizing noise on the reference inputs. This noise is insignificant with a 5V reference but will become a larger fraction of an LSB as the size of the LSB is reduced. The typical curve of Noise Error vs Reference Voltage shows the LSB contribution of this 200 μ V of noise.

For operation with a 5V reference, the 200 μ V noise is only 0.04LSB peak-to-peak. In this case, the LTC1090 noise will contribute virtually no uncertainty to the output code. However, for reduced references, the noise may become a significant fraction of an LSB and cause undesirable jitter in the output code. For example, with a 1V reference, this same 200 μ V noise is 0.2LSB peak-to-peak. This will reduce the range of input voltages over which a stable output code can be achieved by 0.2LSB. If the reference is further reduced to 200mV, the 200 μ V noise becomes equal to one LSB and a stable code may be difficult to achieve. In this case averaging readings may be necessary.

This noise data was taken in a very clean setup. Any setup induced noise (noise or ripple on V_{CC} , V_{REF} , V_{IN} or V^-) will add to the internal noise. The lower the reference voltage to be used, the more critical it becomes to have a clean, noise-free setup.

TYPICAL APPLICATION

A “Quick Look” Circuit for the LTC1090

Users can get a quick look at the function and timing of the LTC1090 by using the following simple circuit. REF⁺ and D_{IN} are tied to V_{CC} selecting a 5V input span, CH7 as a single ended input, unipolar mode, MSB first format and 16-bit word length. ACLK and SCLK are tied together and driven by an external clock. CS is driven at 1/64 the clock rate by the CD4520 and D_{OUT} outputs the data. All other pins are tied to a ground plane. The output data from the D_{OUT} pin can be viewed on an oscilloscope which is set up to trigger on the falling edge of CS.

A “Quick Look” Circuit for the LTC1090

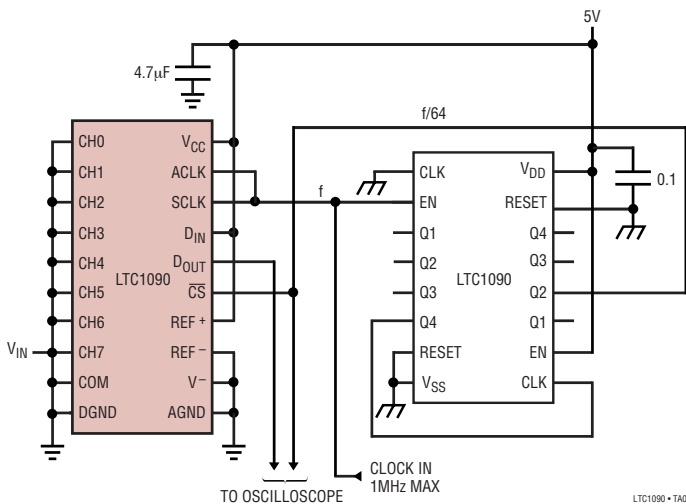

SNEAK-A-BIT™

The LTC1090’s unique ability to software select the polarity of the differential inputs and the output word length is used to achieve one more bit of resolution. Using the circuit below with two conversions and some software, a 2’s complement 10-bit + sign word is returned to memory inside the MPU. The MC68HC05C4 was chosen as an example; however, any processor could be used.

Two 10-bit unipolar conversions are performed: the first over a 0 to 5V span and the second over a 0 to –5V span (by reversing the polarity of the inputs). The sign of the input is determined by which of the two spans contained it. Then the resulting number (ranging from –1023 to 1023 decimal) is converted to 2’s complement notation and stored in RAM.

Scope Trace of LTC1090 “Quick Look” Circuit Showing A/D Output of 0101010101 (155_{HEX})

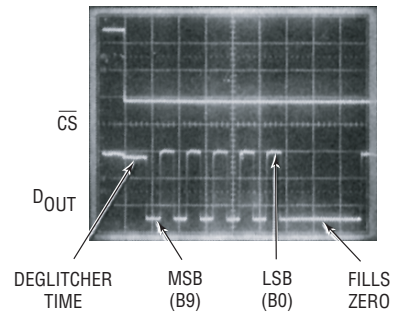

SNEAK-A-BIT Circuit

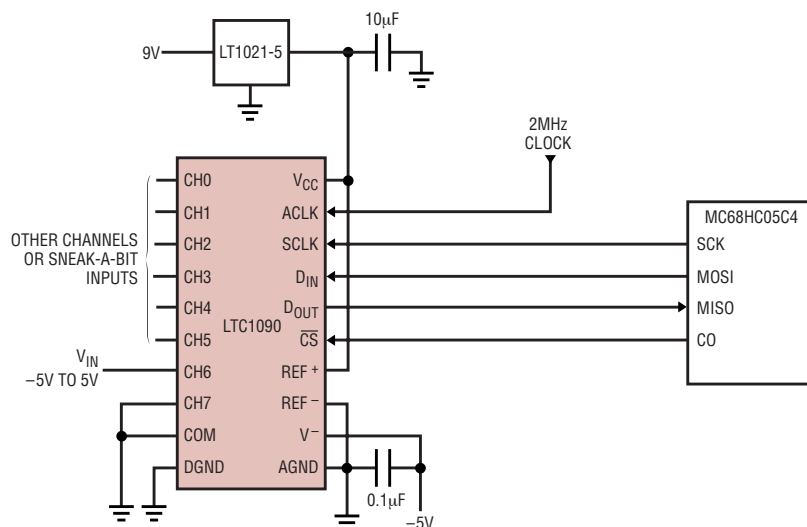

SNEAK-A-BIT is a trademark of Linear Technology Corp.

LTC1090 • TA04

1090fc

TYPICAL APPLICATION

SNEAK-A-BIT

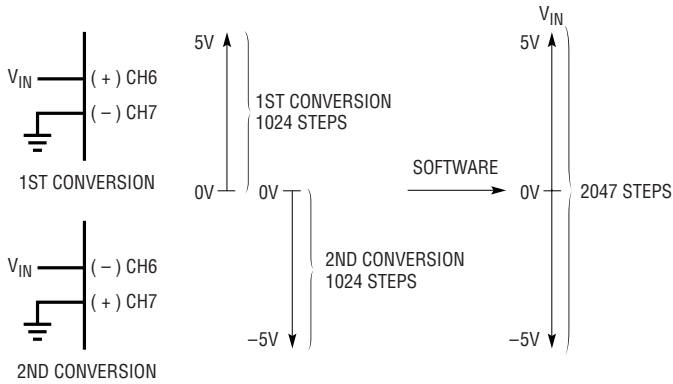

SNEAK-A-BIT Code

D_{OUT} from LTC1090 in MC68HC05C4 RAM

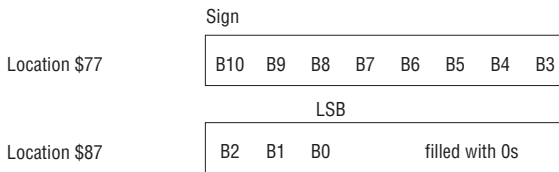

D_{IN} words for LTC1090

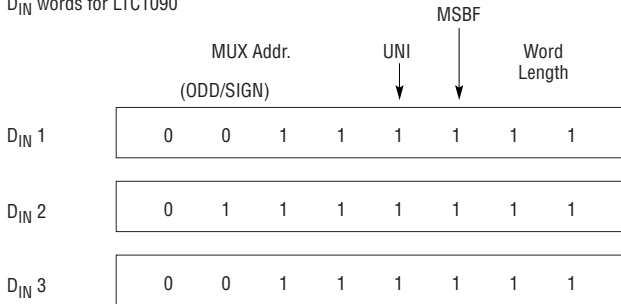

LTC1090 • TA05

Sneak-A-Bit Code for the LTC1090 Using the MC68HC05C4

MNEMONIC	DESCRIPTION
LDA #\$50	Configuration data for SPCR
STA \$0A	Load configuration data into \$0A
LDA #\$FF	Configuration data for port C DDR
STA \$06	Load configuration data into port C DDR
BSET 0, \$02	Make sure CS is high
JSR READ-/+	Dummy read configures LTC1090 for next read
JSR READ+/-	Read CH6 with respect to CH7
JSR READ-/+	Read CH7 with respect to CH6
JSR CHK SIGN	Determines which reading has valid data, converts to 2's complement and stores in RAM

Sneak-A-Bit Code for the LTC1090 Using the MC68HC05C4

MNEMONIC	DESCRIPTION	
READ-/+:	LDA #\$3F JSR TRANSFER LDA \$60 STA \$71 LDA \$61 STA \$72 RTS	Load D _{IN} word for LTC1090 into ACC Read LTC1090 routine Load MSBs from LTC1090 into ACC Store MSBs in \$71 Load LSBs from LTC1090 into ACC Store LSBs in \$72 Return
READ+/-:	LDA #\$7F JSR TRANSFER LDA \$60 STA \$73 LDA \$61 STA \$74 RTS	Load D _{IN} word for LTC1090 into ACC Read LTC1090 routine Load MSBs from LTC1090 into ACC Store MSBs in \$73 Load LSBs from LTC1090 into ACC Store LSBs in \$74 Return
TRANSFER:	BCLR 0, \$02 STA \$0C	CS goes low Load D _{IN} into SPI. Start transfer
LOOP 1:	TST \$0B BPL LOOP 1 LDA \$0C STA \$0C STA \$60	Test status of SPIF Loop to previous instruction if not done Load contents of SPI data reg into ACC Start next cycle Store MSBs in \$60
LOOP 2:	TST \$0B BPL LOOP 2 BSET 0, \$02 LDA \$0C STA \$61 RTS	Test status of SPIF Loop to previous instruction if not done CS goes high Load contents of SPI data reg into ACC Store LSBs in \$61 Return
CHK SIGN:	LDA \$73 ORA \$74 BEQ MINUS CLC ROR \$73 ROR \$74 LDA \$73 STA \$77 LDA \$74 STA \$87 BRA END	Load MSBs of +/- read into ACC Or ACC (MSBs) with LSBs of +/- read If result is 0 goto minus Clear carry Rotate right \$73 through carry Rotate right \$74 through carry Load MSBs of +/- read into ACC Store MSBs in RAM location \$77 Load LSBs of +/- read into ACC Store LSBs in RAM location \$87 Goto end of routine
MINUS:	CLC ROR \$71 ROR \$72 COM \$71 COM \$72 LDA \$72 ADD #\$01 STA \$72 CLRA ADC \$71 STA \$71 STA \$77 LDA \$72 STA \$87 RTS	Clear carry Shift MSBs of +/- read right Shift LSBs of +/- read right 1's complement of MSBs 1's complement of LSBs Load LSBs into ACC Add 1 to LSBs Store ACC in \$72 Clear ACC Add with carry to MSBs. Result in ACC Store ACC in \$71 Store MSBs in RAM location \$77 Load LSBs in ACC Store LSBs in RAM location \$87 Return
END:	RTS	Return

PACKAGE DESCRIPTION

J Package
20-Lead CERDIP (Narrow .300 Inch, Hermetic)
 (Reference LTC DWG # 05-08-1110)

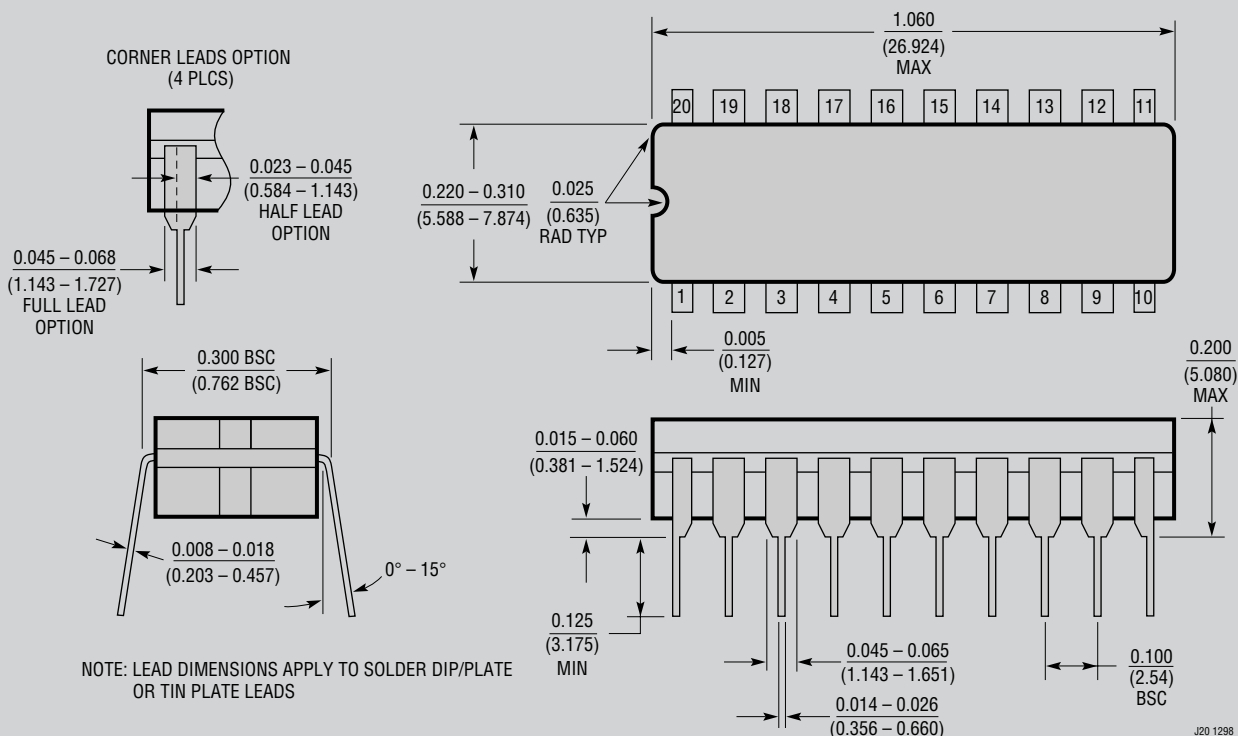

NOTE: LEAD DIMENSIONS APPLY TO SOLDER DIP/PLATE OR TIN PLATE LEADS

J20 1298

OBsolete PACKAGE

PACKAGE DESCRIPTION

N Package
20-Lead PDIP (Narrow .300 Inch)
 (Reference LTC DWG # 05-08-1510)

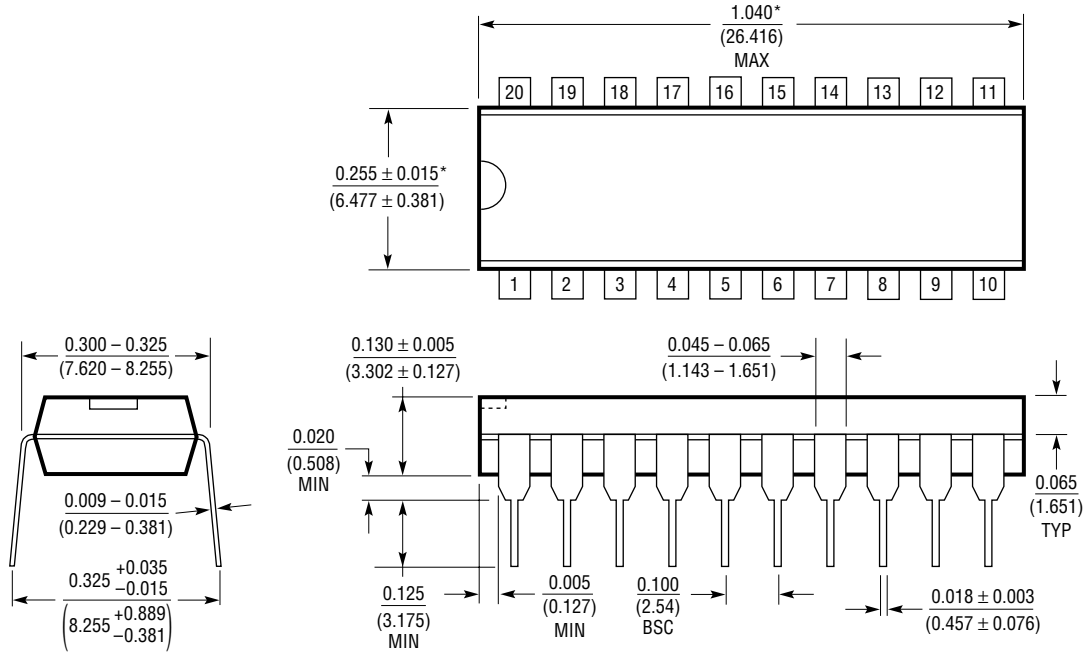

*THESE DIMENSIONS DO NOT INCLUDE MOLD FLASH OR PROTRUSIONS.
 MOLD FLASH OR PROTRUSIONS SHALL NOT EXCEED 0.010 INCH (0.254mm)

N20 1098

PACKAGE DESCRIPTION

SW Package 20-Lead Plastic Small Outline (Wide .300 Inch) (Reference LTC DWG # 05-08-1620)

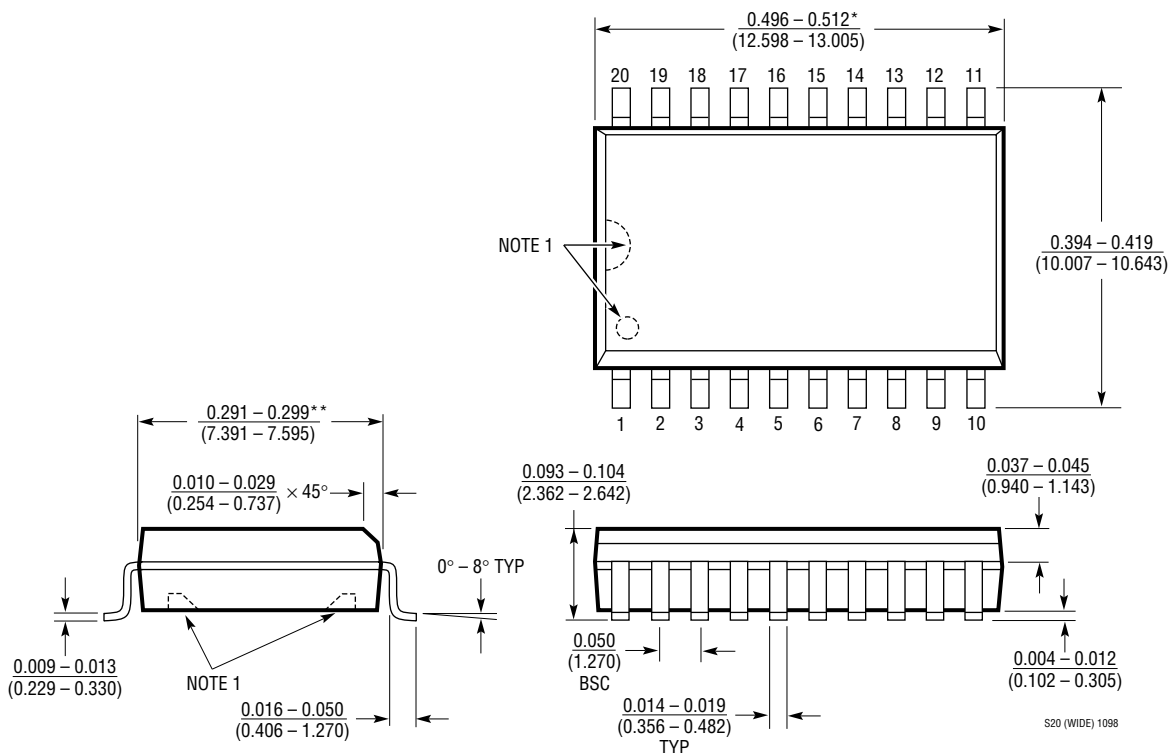

NOTE:

1. PIN 1 IDENT, NOTCH ON TOP AND CAVITIES ON THE BOTTOM OF PACKAGES ARE THE MANUFACTURING OPTIONS. THE PART MAY BE SUPPLIED WITH OR WITHOUT ANY OF THE OPTIONS

*DIMENSION DOES NOT INCLUDE MOLD FLASH. MOLD FLASH SHALL NOT EXCEED 0.006" (0.152mm) PER SIDE

**DIMENSION DOES NOT INCLUDE INTERLEAD FLASH. INTERLEAD FLASH SHALL NOT EXCEED 0.010" (0.254mm) PER SIDE

LTC1090

RELATED PARTS

PART NUMBER	DESCRIPTION	COMMENTS
LTC1290	8-Channel Configurable, 5V, 12-Bit ADC	Pin-Compatible with LTC1090
LTC1391	Serial-Controlled 8-to-1 Analog Multiplexer	Low R_{ON} , Low Power, 16-Pin SO and SSOP Package
LTC1594L/LTC1598L	4-/8-Channel, 3V Micropower 12-Bit ADC	Low Power, Small Size
LTC1850/LTC1851	10-Bit/12-Bit, 8-Channel, 1.25Msps ADCs	5V, Programmable MUX and Sequencer
LTC1852/LTC1853	10-Bit/12-Bit, 8-Channel, 400ksps ADCs	3V or 5V, Programmable MUX and Sequencer
LTC2404/LTC2408	24-Bit, 4-/8-Channel, No Latency $\Delta\Sigma^{\text{TM}}$ ADC	4ppm INL, 10ppm Total Unadjusted Error, 200 μ A
LTC2424/LTC2428	20-Bit, 4-/8-Channel, No Latency $\Delta\Sigma$ ADC	1.2ppm Noise, 8ppm INL, Pin Compatible with LTC2404/LTC2408

No Latency $\Delta\Sigma$ is a trademark of Linear Technology Corporation.