

IC DATA SHEET



LDO REGULATOR WITH ON/OFF SWITCH
TK717xx

TK717xx

Features

- **Built-in shunt circuit of output to GND. Charged energy of output capacitor is discharged quickly.**
- **Built-in PNP power transistor. Very small Dropout Voltage (Vdrop=163mV at Iout= 200mA)**
- **Very good stability (CL=0.22 μ F is stable for any type capacitor with 2.0V Vout)**
- **High accuracy out put voltage (± 50 mV or $\pm 1.5\%$)**
- **Good ripple rejection ratio (80dB at 1KHz Iout=10mA)**
- **Wide operating voltage range (1.8V ~ 14V)**
- **Built-in short circuit protection**
- **Built-in over temperature protection**
- **Suitable for low noise applications**
- **Available with on / off control (High / on). Off time input current becomes pA level**
- **Very small package**

Description

The TK717xx is an integrated circuit with a silicon monolithic bipolar structure. The regulator is of the low saturation voltage output type with very little quiescent current (72 μ A).

The PNP power transistor is built-in. The I/O voltage difference is 163 mV (typical) when a current of 200mA is supplied to the system. Because of the low voltage drop, the voltage source can be effectively used; this makes it very suitable for battery powered equipment.

The on/off function is built into the IC. The current during standby mode becomes very small (pA level). In addition, the output short-circuit function works at off times. It is a unique characteristic by which the residual charge of the output side capacitor is rapidly discharged.

The output voltage is available from 1.5 to 10.0V in 0.1V steps. The output voltage is trimmed with high accuracy. This allows the optimum voltage to be selected for the equipment.

The over current sensor circuit and the reverse-bias protection circuit are built-in.

It is a very rugged design because the ESD protection is high. Therefore, the TK717xx can be used with confidence. When mounted on the PCB, the power dissipation rating becomes about 500mW, even though the package is very small.

The TK717xx features very high stability in both DC and AC. The capacitor on the output side provides stable operation with 0.22 μ F with 2.0V Vout. A capacitor of any type can be used; however, the larger this capacitor is, the better the overall characteristics are.

ORDERING INFORMATION

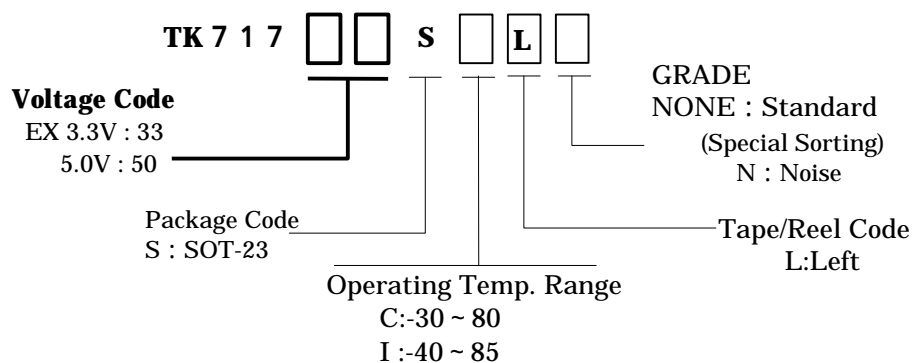

Boldface type applies **Standard Voltage**.

V OUT	V CODE	V OUT	V CODE	V OUT	V CODE	V OUT	V CODE
1.5 v	15	2.5 v	25	3.5 v	35	4.5 v	45
1.6	16	2.6	26	3.6	36	4.6	46
1.7	17	2.7	27	3.7	37	4.7	47
1.8	18	2.8	28	3.8	38	4.8	48
1.9	19	2.9	29	3.9	39	4.9	49
2.0	20	3.0	30	4.0	40	5.0	50
2.1	21	3.1	31	4.1	41		
2.2	22	3.2	32	4.2	42		
2.3	23	3.3	33	4.3	43		
2.4	24	3.4	34	4.4	44		

Please contact your authorized Toko representative for voltage availability

Absolute maximum ratings

Parameters	Symbol	Limiting Values	Unit
Supply voltage	V _{cc} Max	- 0.4 ~ 16	V
Reverse bias	V _r Max	- 0.4 ~ 6	V
Np pin voltage	V _{np} Max	- 0.4 ~ 5	V
Control pin voltage	V _{cont} Max	- 0.4 ~ 16	V
Storage temperature Range	T _{stg}	- 55 ~ 150	
Operating voltage range	V _{op}	1.8 ~ 14	V
Operating temperature range	T _{op}	-30 ~ 80	
Short circuit current	I _{short}	410	mA
Power dissipation	Internally limited (150mW free air)		500mW mounted (reference)

Electronic characteristics

V_{test}=V_{out}_{TYP}+1V V_{cont}=1.8V (Ta = 25)

Parameters	Symbol	Min	Typ	Max	Unit	Condition	
Output voltage	V _{out}	See table 1					
Line regulation	LinReg		0	5	mV	V _{test} =V _{out} _{TYP} +1V---- V _{out} _{TYP} +6V V=5V	
Load regulation	LoaReg		(8)	(23)	mV	5mA < I _{out} < 100mA Note1	
			(21)	(58)	mV	5mA < I _{out} < 200mA Note1	
Dropout voltage	V _{drop}		65	130	mV	I _{out} =50mA	
			103	200	mV	I _{out} =100mA	
			163	300	mV	I _{out} =200mA (2.4V Vout)	
			163	300	mV	I _{out} =180mA (2.1V Vout < 2.4V)	
			1.5V Vout 2.0V : No regulation				Because of V _{op} Min=1.8V
Maximum output current	I _{out} Max	280	370		mA	When (V _{out} _{TYP} × 0.9)	
			250			1.8V Vcc 2.1V Reference Value	
Quiescent current	I _q		72	110	μA	I _{out} =0mA Excluding I _{cont}	
Ground pin current	I _{gnd}		0.8	1.5	mA	I _{out} =50mA	
Standby current	I _{standby}		0.0	0.1	μA	V _{cc} = 8 V, V _{cont} 0.15V Off state	
Discharge current	I _{dis}	19	29		mA	V _{rev} =2V off state (71720)	
		25	38		mA	V _{rev} =3V off state (71730)	
		27	41		mA	V _{rev} =4V off state (71740)	
		29	44		mA	V _{rev} =5V off state (71750)	
Control terminal Specification (Pull down resistor =None (Note 2)							
Control current	I _{cont}		0.86	2.5	μA	V _{cont} = 1.8 v on state	
Control voltage	V _{cont}	1.6			V	on state	
				0.6	V	off state	
Np terminal Voltage	V _{Np}	1.26			V		
V _o	V _o /Ta	Typ=25 ppm/				Reference Value	
Out put noise	V _{no}	0.14 ~ 0.25 μV/ Hz at 1KHz				Reference Value	

Note 1: This value depends on the output voltage (this is a value for a V_{out}=3V device.)

This value improves in a low voltage device.

Note 2: The input current decreases to the pA level by connecting the control terminal to GND. (Off state)

General Note: Limits are guaranteed by production testing or correction techniques using Statistical Quality Control (SQC) methods. Unless otherwise noted. V_{test}=V_{out}_{TYP}+1v; I_L=1mA(T_j=25)The operation of -30 -80 is guaranteed in the design by a usual inspection.

General Note: Exceeding the “Absolute Maximum Rating “ may damage the device

General Note: Connecting a capacitor to the noise bypass pin can decrease the output noise voltage

General Note: Output noise is 0.14-0.25 μV/ Hz at 1KHz : 25 ~ 65 μV_{rms} at BW400-80kHz

General Note: The ripple rejection is 84dB at 400Hz and 80dB at 1kHz.

[CL=1.0 μF,C_{np}=0.01 μF,V_{nois}=200mV_{RMS},Vin=V_{out}_{TYP}+1.5v,I_{out}=10mA]

Table 1

C Rank Output Voltage

Ta=25 Iout=5mA

Output Voltage	Voltage Code	Vout Min	Vout Max	Test Voltage	Output Voltage	Voltage Code	Vout Min	Vout Max	Test Voltage
1.5v	15	1.450v	1.550v	2.5v	3.4 v	34	3.349v	3.451v	4.4v
1.6	16	1.550	1.650	2.6	3.5	35	3.447	3.553	4.5
1.7	17	1.650	1.750	2.7	3.6	36	3.546	3.654	4.6
1.8	18	1.750	1.850	2.8	3.7	37	3.644	3.756	4.7
1.9	19	1.850	1.950	2.9	3.8	38	3.743	3.857	4.8
2.0	20	1.950	2.050	3.0	3.9	39	3.841	3.959	4.9
2.1	21	2.050	2.150	3.1	4.0	40	3.940	4.060	5.0
2.2	22	2.150	2.250	3.2	4.1	41	4.038	4.162	5.1
2.3	23	2.250	2.350	3.3	4.2	42	4.137	4.263	5.2
2.4	24	2.350	2.450	3.4	4.3	43	4.235	4.365	5.3
2.5	25	2.450	2.550	3.5	4.4	44	4.334	4.466	5.4
2.6	26	2.550	2.650	3.6	4.5	45	4.432	4.568	5.5
2.7	27	2.650	2.750	3.7	4.6	46	4.531	4.669	5.6
2.8	28	2.750	2.850	3.8	4.7	47	4.629	4.771	5.7
2.9	29	2.850	2.950	3.9	4.8	48	4.728	4.872	5.8
3.0	30	2.950	3.050	4.0	4.9	49	4.826	4.974	5.9
3.1	31	3.050	3.150	4.1	5.0	50	4.925	5.075	6.0
3.2	32	3.150	3.250	4.2					
3.3	33	3.250	3.350	4.3					

The output voltage table indicates the standard value when manufactured.

I Rank**Absolute Maximum Ratings are same as C Rank****Operating Temperature Range Top=-40 ~ 85****Operating Voltage Range Vop = 2.1V ~ 14V**

Other items are same as C rank.

Boldface type applies over the full operating temperature range. (-40 ~ 85)Vtest=Vout_{Typ}+1V Vcont=1.8V

Parameters	Symbol	Min	T _{yp}	Max	Unit	Condition	
Output voltage	Vout	See table 2					
Line regulation	LinReg		0	5 8	mV	V=5V	
Load regulation	LoaReg		(8)	(23) 31	mV	5mA < IL < 100mA Note1	
			(21)	(58) 72	mV	5mA < IL < 200mA Note1	
Dropout voltage	Vdrop		65	130 180	mV	I out=50mA	
			103	200 270	mV	I out=100mA	
			163	300 350	mV	I out=200mA(2.4V Vout)	
			163	300 350	mV	I out=180mA (2.2V Vout < 2.4V)	
1.5V Vout 2.1V : No regulation Because of Vop _{Min} =2.1V							
Maximum output current	IoutMax	280 250	370		mA	When (Vout _{Typ} × 0.9)	
Quiescent current	Iq		72	110 120	μA	I out=0mA Excluding Icont	
Ground pin current	Ignd		0.8	1.5 1.8	mA	Iout=50mA	
Standby current	Istandby		0.0	0.1 0.5	μA	Vcont 0.15V 出力 Off	
Discharge current	Idis	13	29		mA	V rev=2V off state (71720)	
		17	38		mA	V rev=3V off state (71730)	
		19	41		mA	V rev=4V off state (71740)	
		20	44		mA	V rev=5V off state (71750)	
Control terminal Specification (Pull down resistor =none (Note2)							
Control current	Icont		0.86	2.5 3.0	μA	Vcont = 1.8v 出力 on	
Control Voltage	Vcont	1.6 1.8			V	on state	
				0.6 0.35	V	off state	
Np Terminal Voltage	VNp		1.26		V		
V _o	V _o /T _a	Typ=25 ppm/				Reference value	
Output noise	V _{no}	0.14 ~ 0.25 μV/ Hz at 1KHz				Reference value	

Note 1: This value depends on the output voltage (this is a value for Vout=3V device.)

Note 2: The input current decreases to the pA level by connecting the control terminal to GND. (Off state)

General Note: Limits are guaranteed by production testing or correction techniques using Statistical Quality Control (SQC) methods. Unless otherwise noted. Vtest=Vout_{Typ}+1v ; IL=1mA (Tj=25)

General Note: Exceeding the “Absolute Maximum Rating “ may damage the device

General Note: Connecting a capacitor to the noise bypass pin can decrease the output noise voltage

General Note: Output noise is 0.14-0.25 μV/ Hz at 1KHz : 25 ~ 65 μVrms at BW400-80kHz

General Note: The ripple rejection is 84dB at 400Hz and 80dB at 1kHz.

[CL=1.0 μF, Cnp=0.01 μF, Vnois=200mV_{RMS}, Vin=Vout_{Typ}+1.5v, Iout=10mA]

Table 2

I Rank Output Voltage

Boldface type applies over the full operating temperature range. (Ta=-40 ~ 85) Iout=5mA

Output Voltage	Voltage Code	Vout Min	Vout Max	Test Voltage	Output Voltage	Voltage Code	Vout Min	Vout Max	Test Voltage
1.5V	15	1.450V 1.420	1.550V 1.580	2.5V	3.4 V	34	3.349 V 3.315	3.451 V 3.485	4.4 V
1.6	16	1.550 1.520	1.650 1.680	2.6	3.5	35	3.447 3.412	3.553 3.588	4.5
1.7	17	1.650 1.620	1.750 1.780	2.7	3.6	36	3.546 3.510	3.654 3.690	4.6
1.8	18	1.750 1.720	1.850 1.880	2.8	3.7	37	3.644 3.607	3.756 3.793	4.7
1.9	19	1.850 1.820	1.950 1.980	2.9	3.8	38	3.743 3.705	3.857 3.895	4.8
2.0	20	1.950 1.920	2.050 2.080	3.0	3.9	39	3.841 3.802	3.959 3.998	4.9
2.1	21	2.050 2.020	2.150 2.180	3.1	4.0	40	3.940 3.900	4.060 4.100	5.0
2.2	22	2.150 2.120	2.250 2.280	3.2	4.1	41	4.038 3.997	4.162 4.203	5.1
2.3	23	2.250 2.220	2.350 2.380	3.3	4.2	42	4.137 4.095	4.263 4.305	5.2
2.4	24	2.350 2.320	2.450 2.480	3.4	4.3	43	4.235 4.192	4.365 4.408	5.3
2.5	25	2.450 2.420	2.550 2.580	3.5	4.4	44	4.334 4.290	4.466 4.510	5.4
2.6	26	2.550 2.520	2.650 2.680	3.6	4.5	45	4.432 4.387	4.568 4.613	5.5
2.7	27	2.650 2.620	2.750 2.780	3.7	4.6	46	4.531 4.485	4.669 4.715	5.6
2.8	28	2.750 2.720	2.850 2.880	3.8	4.7	47	4.629 4.582	4.771 4.818	5.7
2.9	29	2.850 2.820	2.950 2.980	3.9	4.8	48	4.728 4.680	4.872 4.920	5.8
3.0	30	2.950 2.920	3.050 3.080	4.0	4.9	49	4.826 4.777	4.974 5.023	5.9
3.1	31	3.050 3.020	3.150 3.180	4.1	5.0	50	4.925 4.875	5.075 5.125	6.0
3.2	32	3.150 3.120	3.250 3.280	4.2					
3.3	33	3.250 3.217	3.350 3.383	4.3					

The output voltage table indicates the standard value when manufactured.

Pin layout

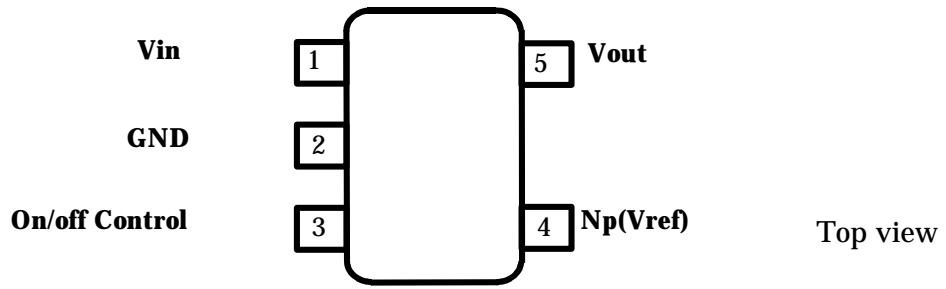

Application

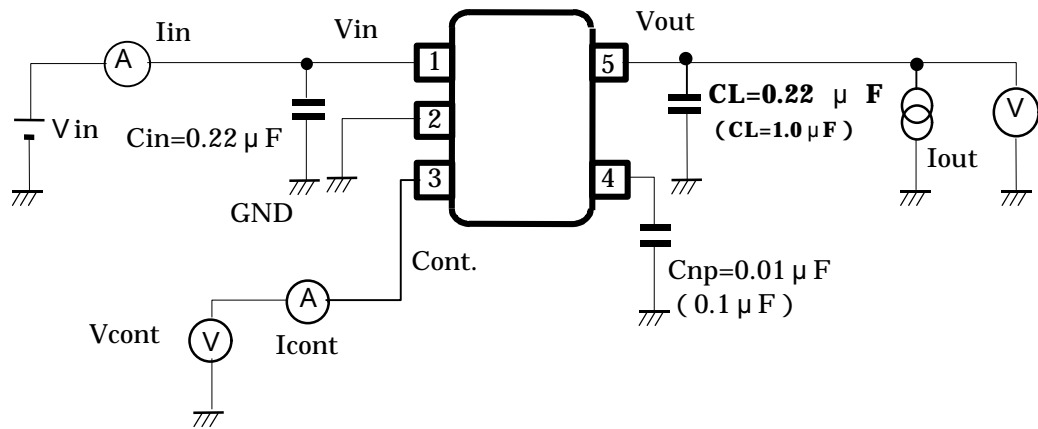

Block diagram

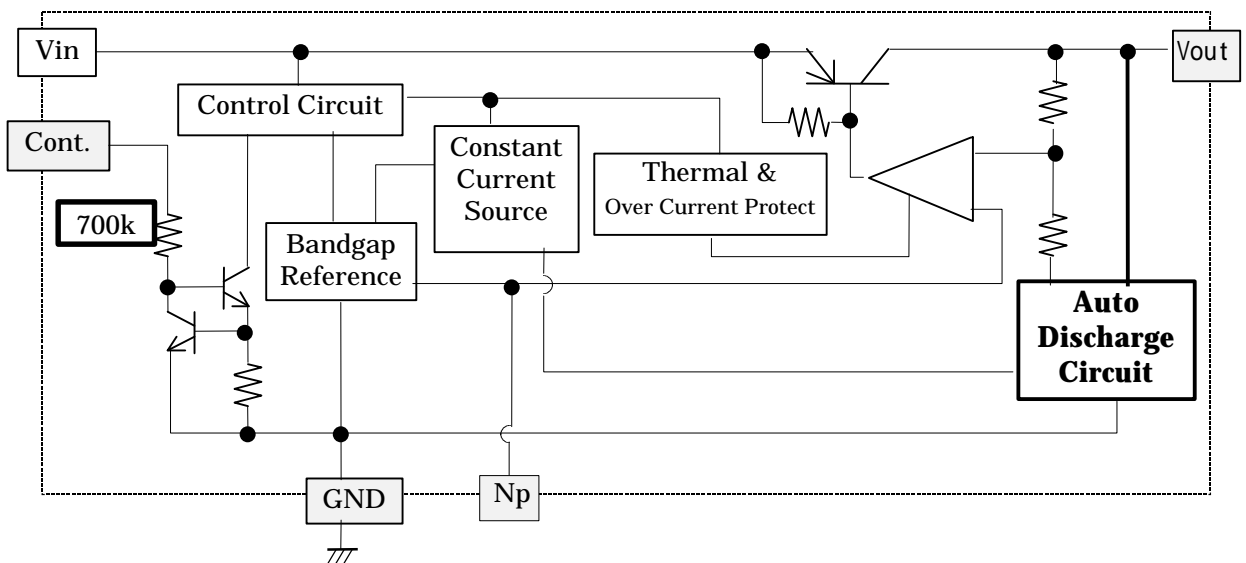

Input /Output Capacitors

Linear regulators require input and output capacitors in order to maintain the regulator's loop stability. The equivalent series resistance (ESR) of the output capacitor must be in the stable operation area. However, it is recommended to use as large a value of capacitance as is practical. The output noise and the ripple noise decrease as the capacitance value increases.

ESR values vary widely between ceramic and tantalum capacitors. However, tantalum capacitors are assumed to provide more ESR damping resistance, which provides greater circuit stability. This implies that a higher level of circuit stability can be obtained by using tantalum capacitors when compared to ceramic capacitors with similar values.

The recommended values: Vout 2.0V : CL 0.22 μ F. Iout 0.5mA
 Vout 1.5V : CL 0.47 μ F. Iout 0.5mA
 The exception to this is at low output current.

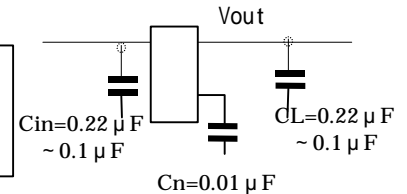

The input capacitor is necessary when the battery is discharged, the power supply impedance increases, or the line distance to the power supply is long. This capacitor might be necessary on each individual IC even if two or more regulator ICs are used. It is not possible to determine this indiscriminately. Please confirm the stability while mounted. The IC provides stable operation with an output side capacitor of 0.22 μ F (Vout 2.0V). If it is 0.1 μ F or more over the full range of temperature, either a ceramic capacitor or tantalum capacitor can be used without considering ESR.

Stable operation area vs. voltage, current, and ESR (at 100kHz)

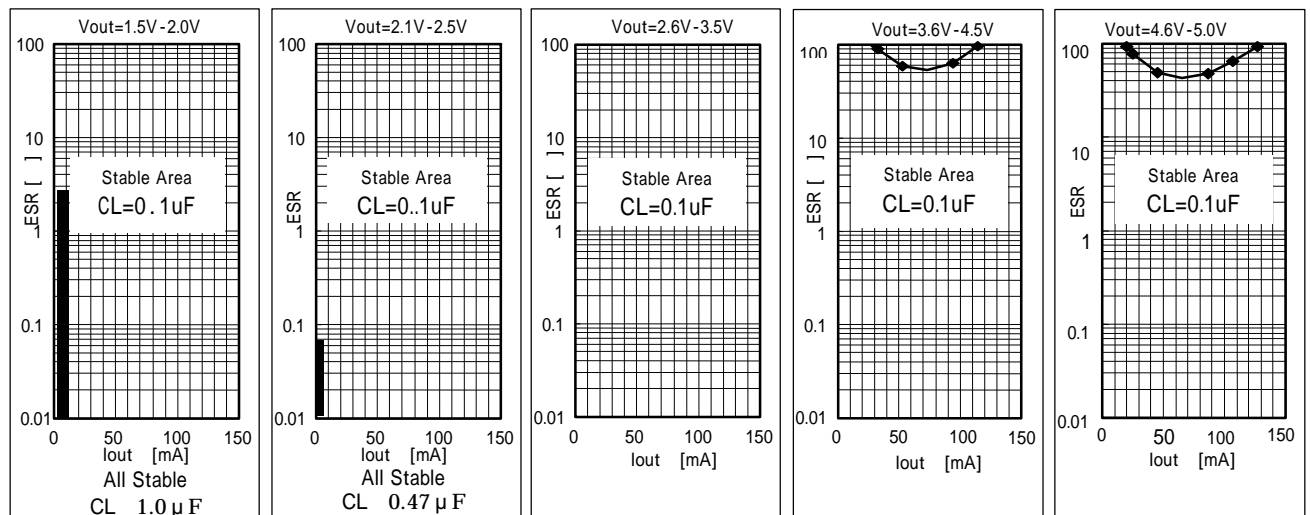

Please increase the output capacitor value when the load current is 0.5 mA or less. The stability of the regulator improves if a big output side capacitor is used (the stable operation area extends.)

Low Voltage device: Please increase the output capacitor like 1.0 μ F when the load current is used by 0.5mA or less.

For evaluation KYOCERA CM05B104K10AB, CM05B224K10AB, CM105B104K16A, CM105B224K16A, CM21B225K10A
 MURATA GRM36B104K10, GRM42B104K10 GRM39B104K25, GRM39B224K10, GRM39B105K6.3

Please increase the output capacitor to 1.0 μ F when the load current is 0.5mA or less.

Bias Voltage and Temperature Characteristics of Ceramic Capacitor

Generally, a ceramic capacitor has both a temperature characteristic and a voltage characteristic. Please consider both characteristics when selecting the part. The B curves are the recommended characteristics.

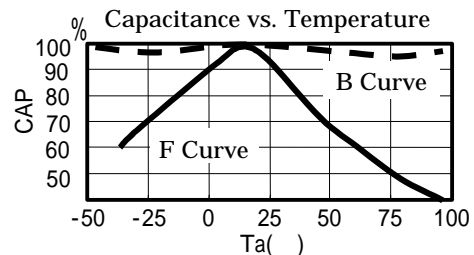
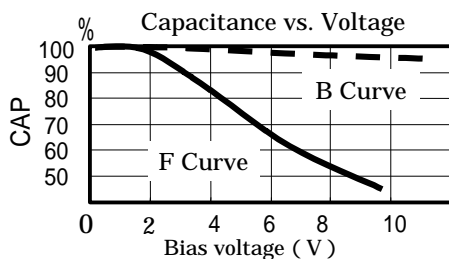

Output noise

TK71730S Cnp vs Noise Iout=30mA BPF=400Hz ~ 80kHz (MLCC stands for Multi Layer Ceramic Capacitor)

Noise(uVrms) Cnp vs Noise

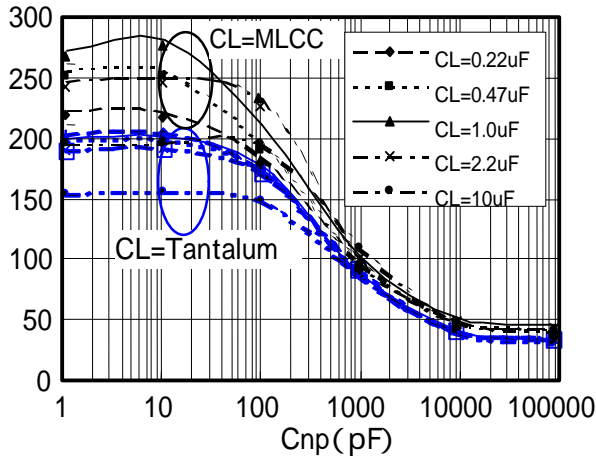

Vout vs Noise

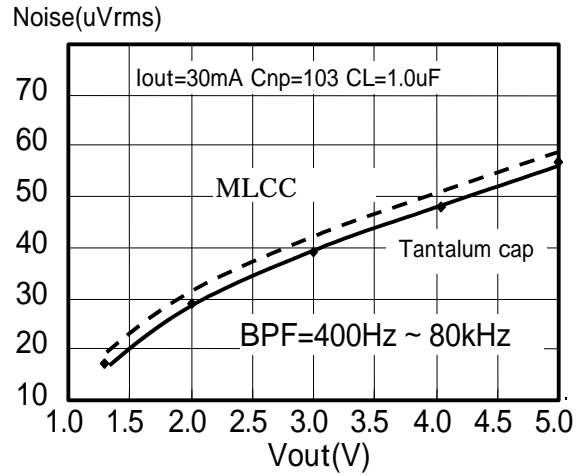

Noise(uVrms) CL=Tantalum Cnp=103

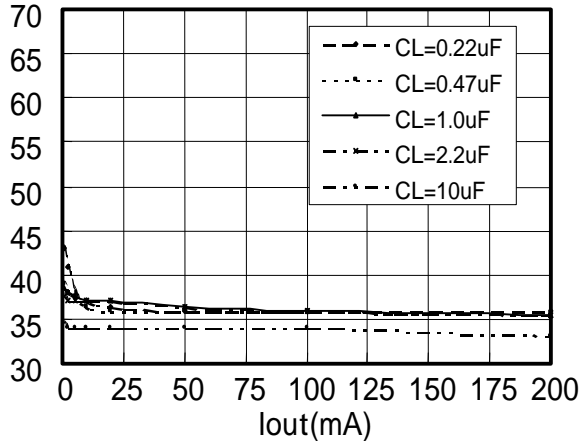

Noise(uVrms) CL=MLCC Cnp=103

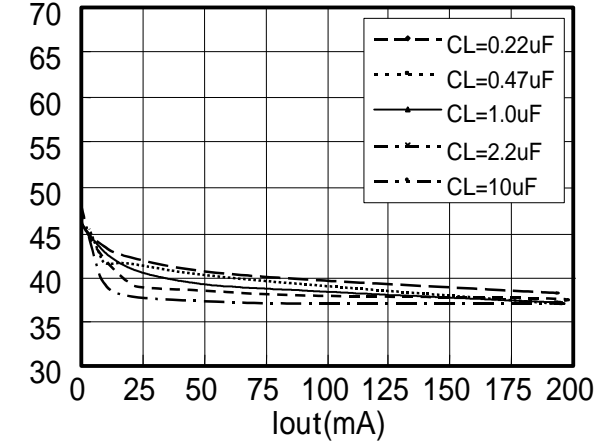

For better noise reduction, it is more effective to increase Cnp without increasing CL. The recommended Cnp capacitance is 6800pF (682) or 0.01 μ F (103). As the output voltage increases, the noise will also increase.

Please increase this capacitance when low noise is demanded. The IC does not operate abnormally about 0.1 and 0.22 μ F.

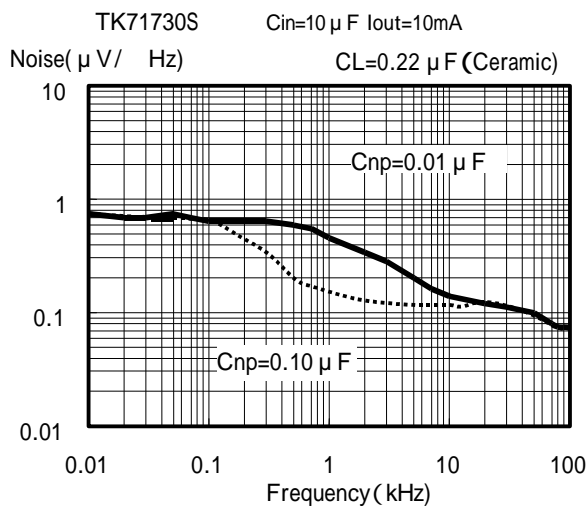

MLCC stands for Multi Layer Ceramic Capacitor.

TANTAL stands for Tantalum Capacitor.

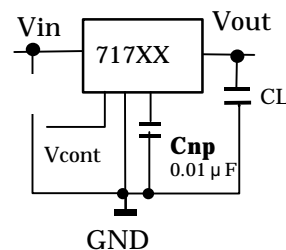

Ripple rejection

$V_{in}=5.0V$ $V_{out}=3.0V$ $I_{out}=10mA$ $VR=500mVp-p$ $f=100 \sim 1MHz$ $C_{in}=0 pF$ $C_{np}=0.01\mu F$

M.L.Ceramic Capacitor

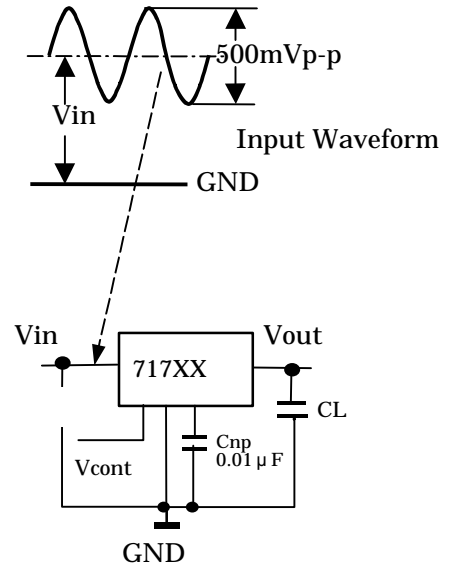
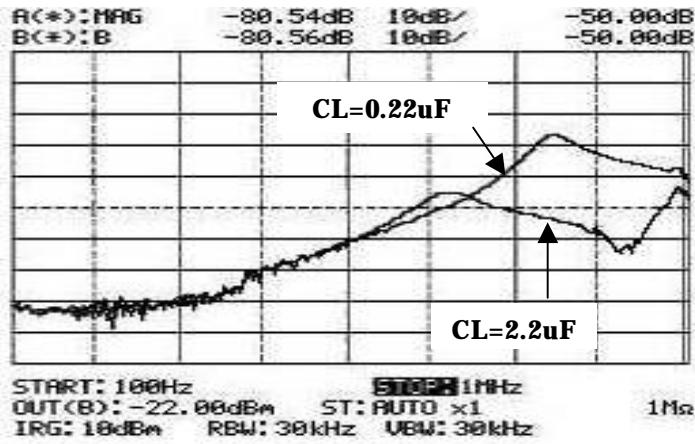

Tantalum Capacitor

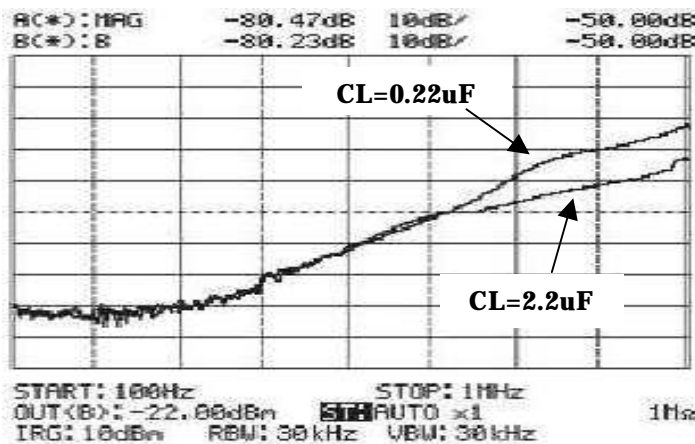

The ripple rejection characteristic depends on the characteristic and the capacitance value of the capacitor connected to the output side. The RR characteristic of 50KHz or more varies greatly with the capacitor on the output side and PCB pattern. If necessary, please confirm stability while operating.

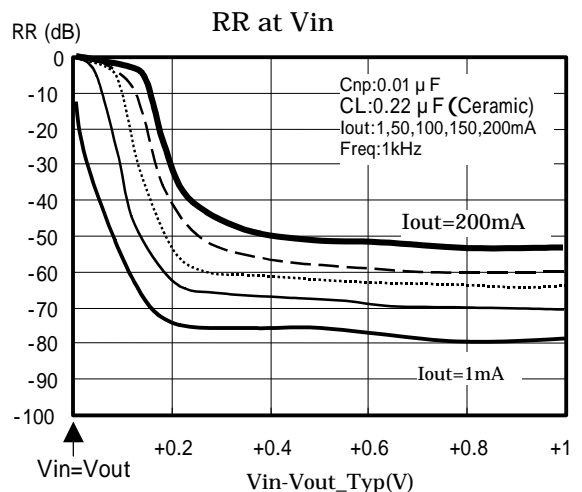
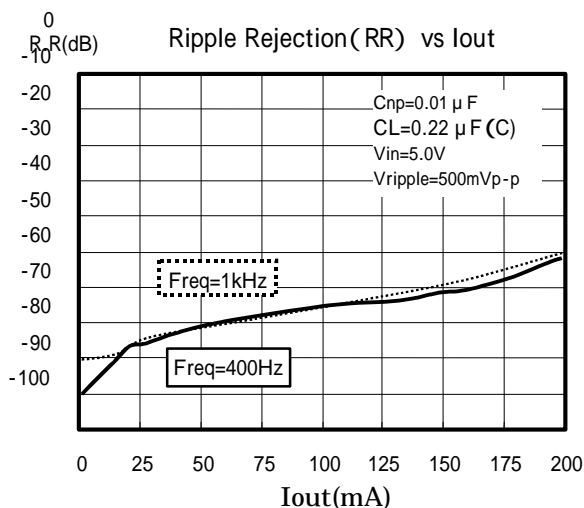

The stability level to a rapid power-supply voltage change and a load current change greatly depends on the value of the output side capacitor and the noise bypass capacitor.

Please refer to the figure below.

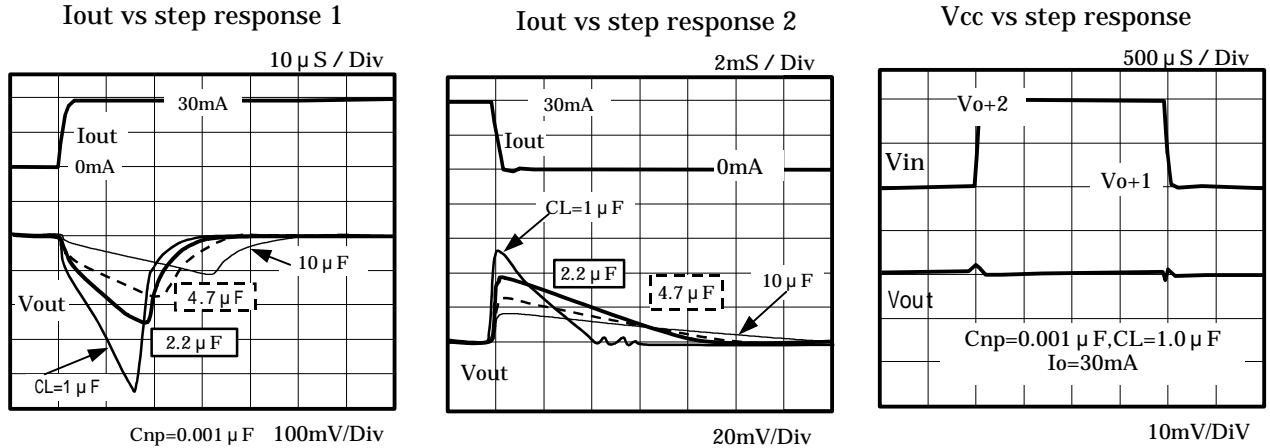

If the current is thrown into the load, the step response is settled fast.

On / off Speed

The on/off switching speed quickens when the Cnp and CL capacitance is reduced. However, the Load transient and Line transient response deteriorate when the capacitance is small. In addition, the noise increases. We will recommend CL=0.22 μ F and Cnp=1000pF to the demand of high-speed operation. Please increase each capacitance when low noise is desired. The on/off switch speed greatly depends on the value of the output side capacitor and the noise bypass capacitor. Please refer to the figures below.

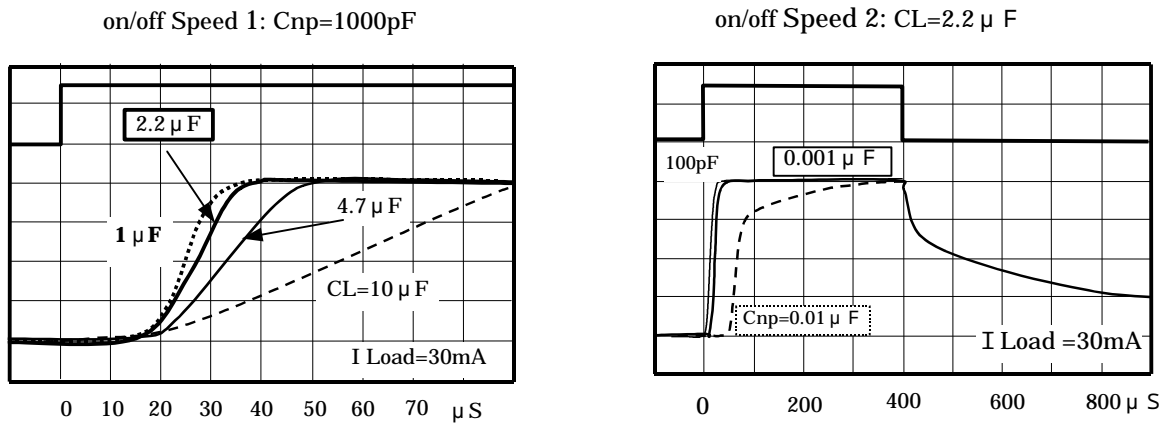

on \rightarrow off Speed: CL=2.2 μ F, Cnp=1000pF I Load=0mA

- TK717xx has a short circuit during off.
- TK716xxS and AS have a Disconnect circuit during off.
- TK111xxC is a normal regulator.

Please refer to the figure.

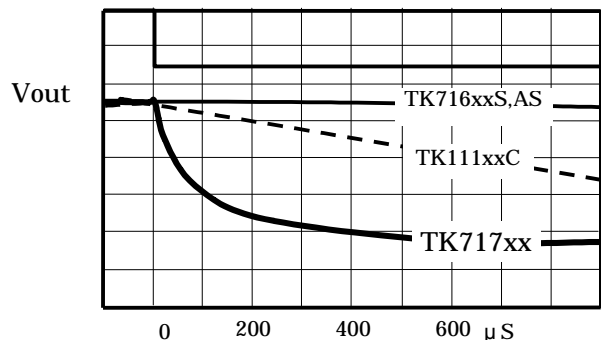

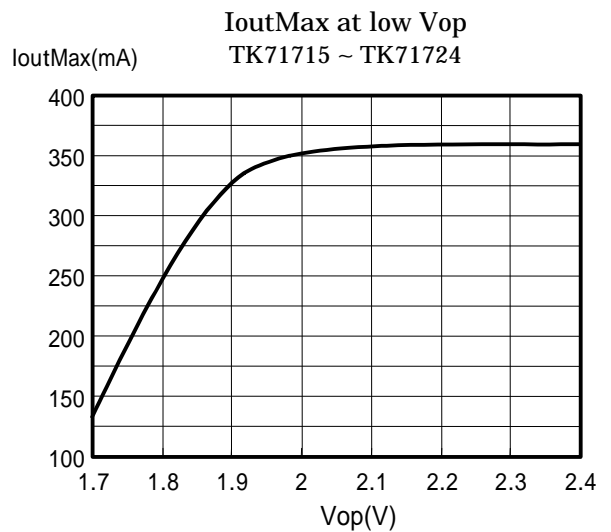
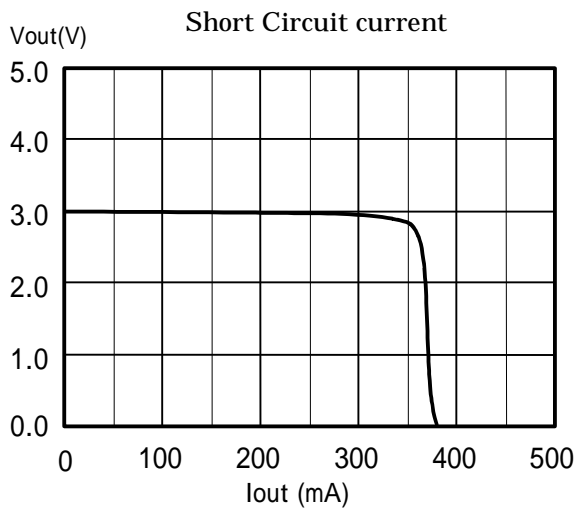
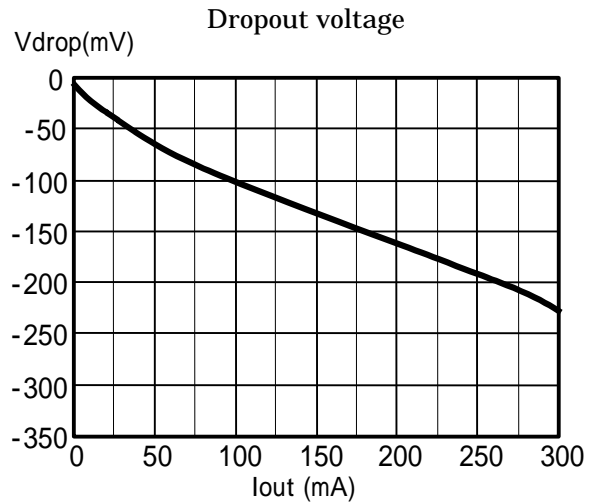
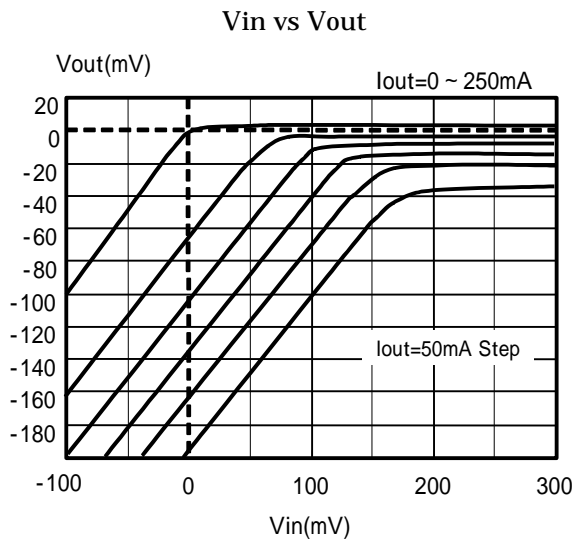
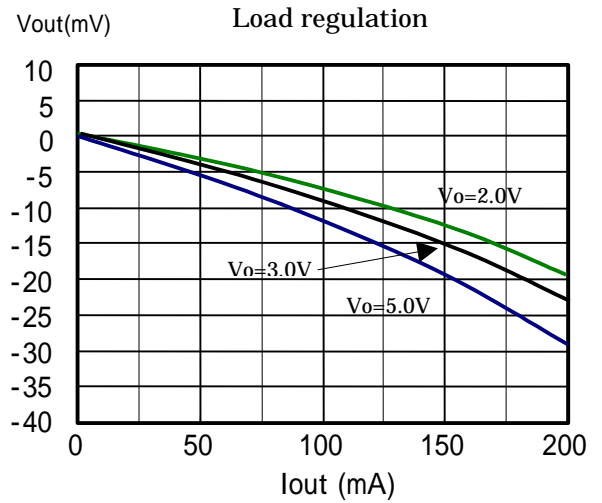
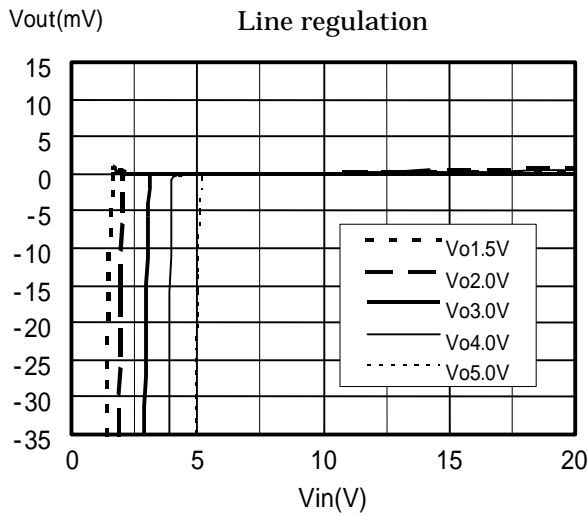

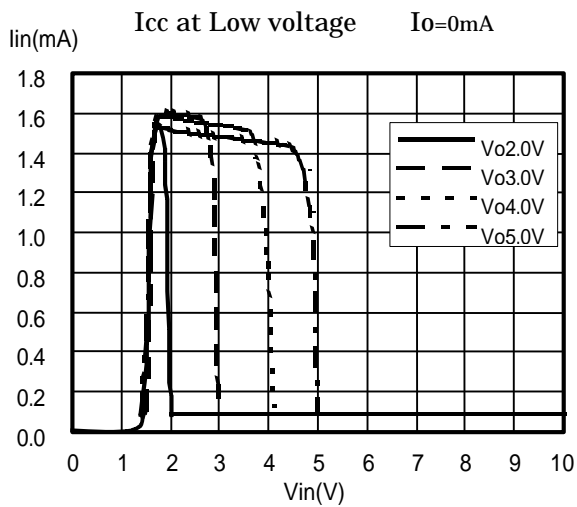
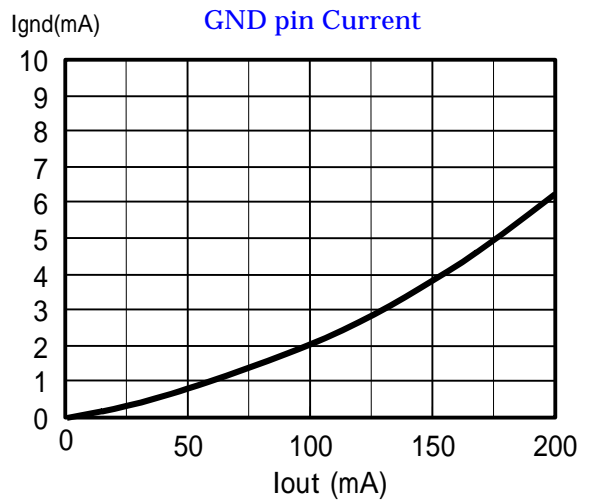
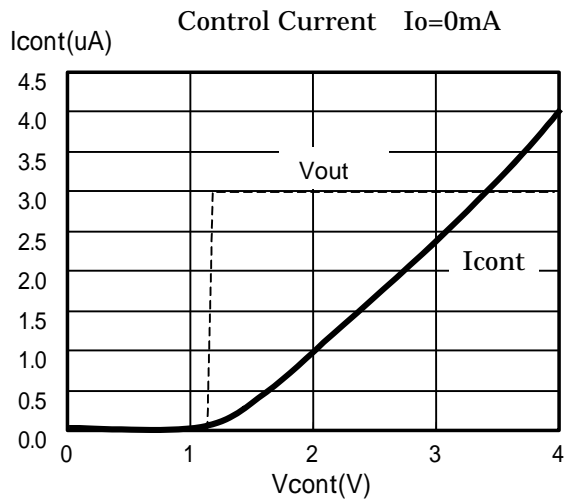
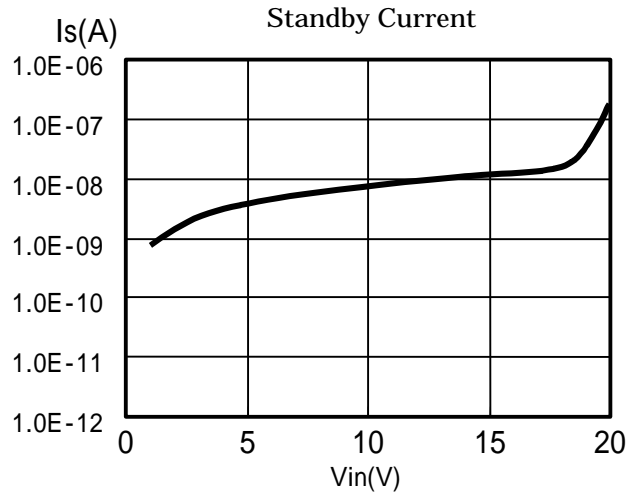
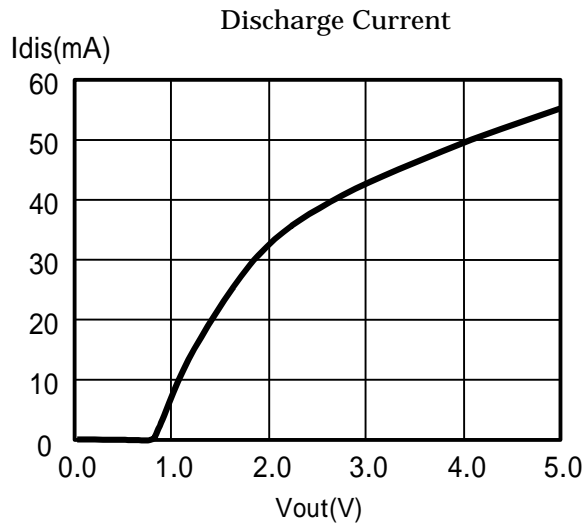

Temperature characteristics-1

(Ta: Ambient temperature)

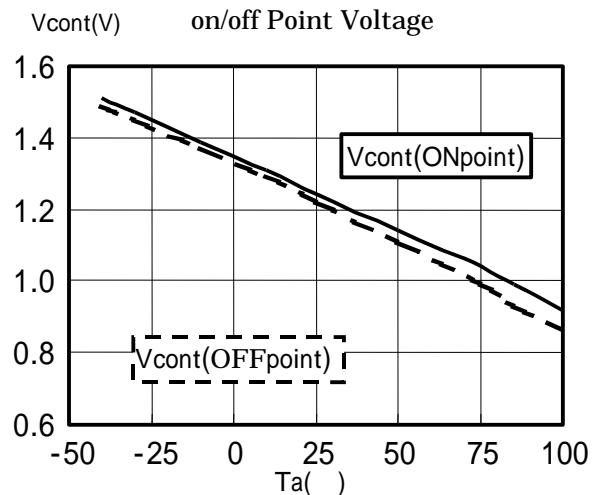
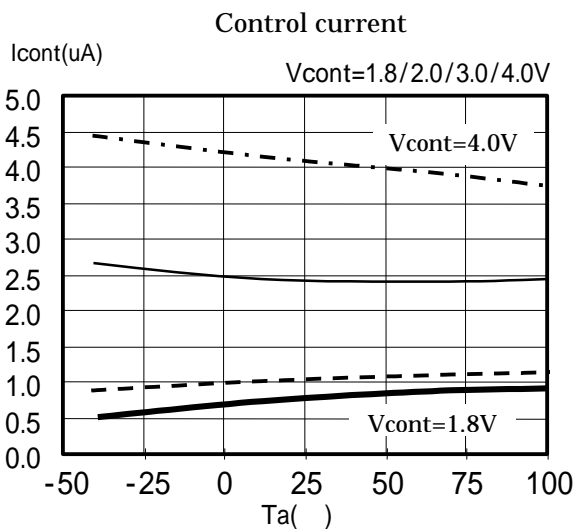
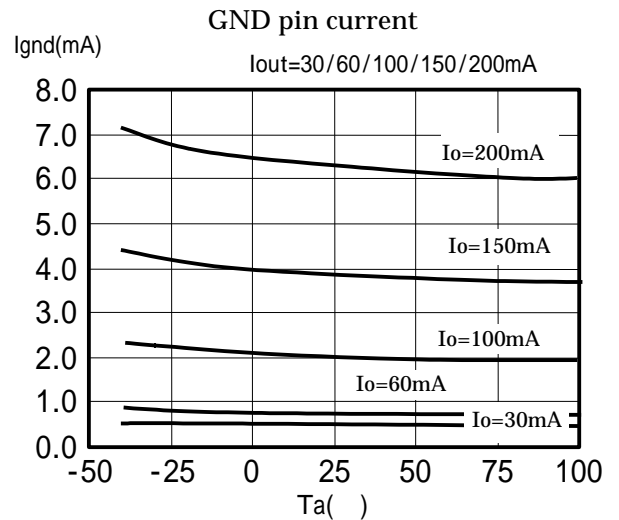
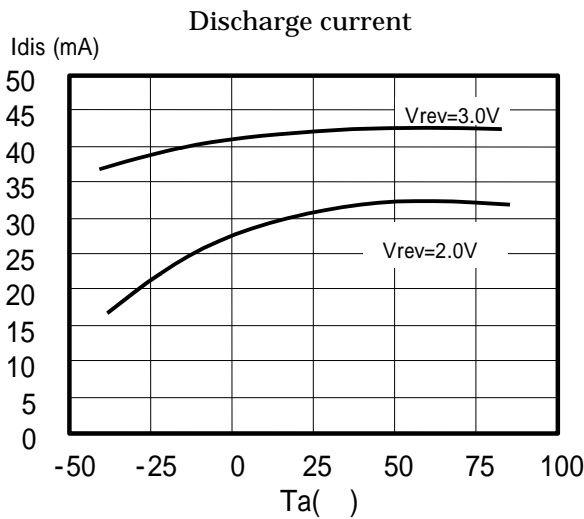
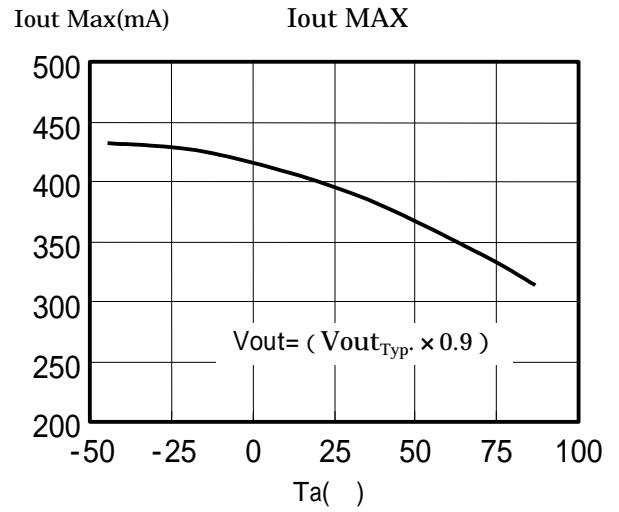
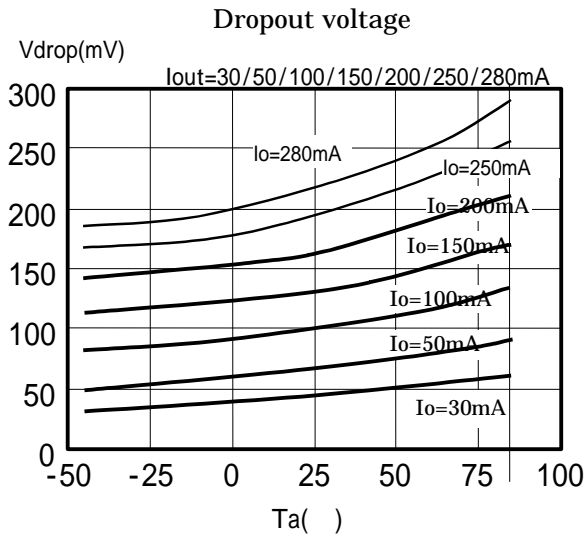

Temperature characteristics-2 Output voltage (Ta: Ambient temperature)

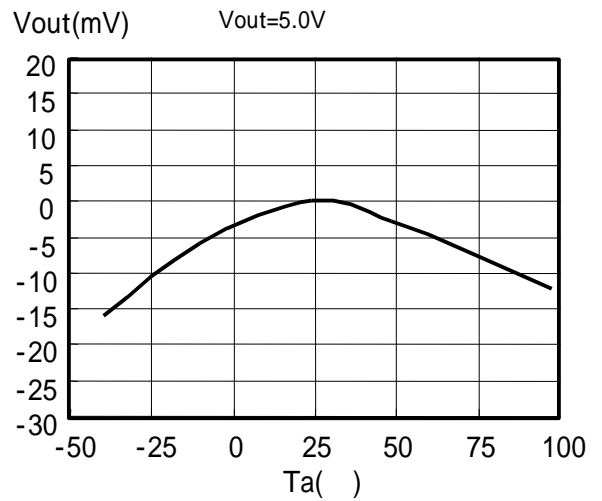
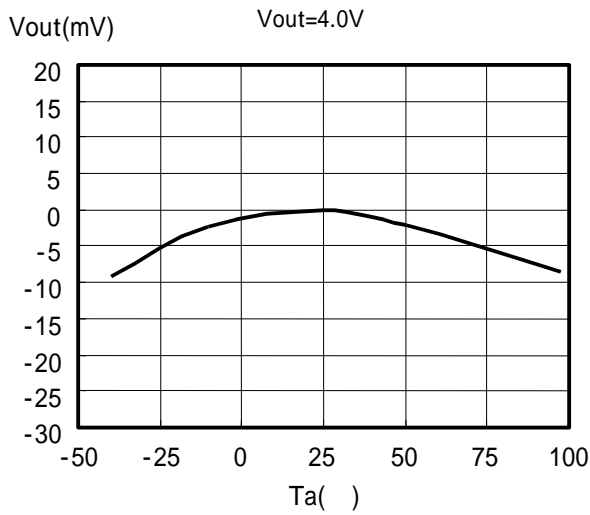
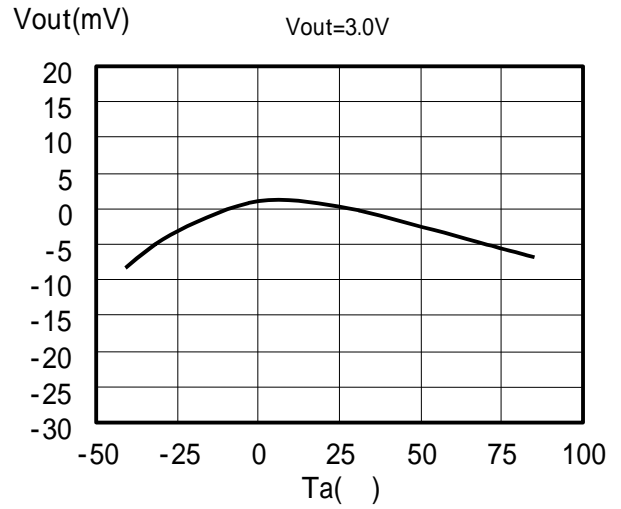
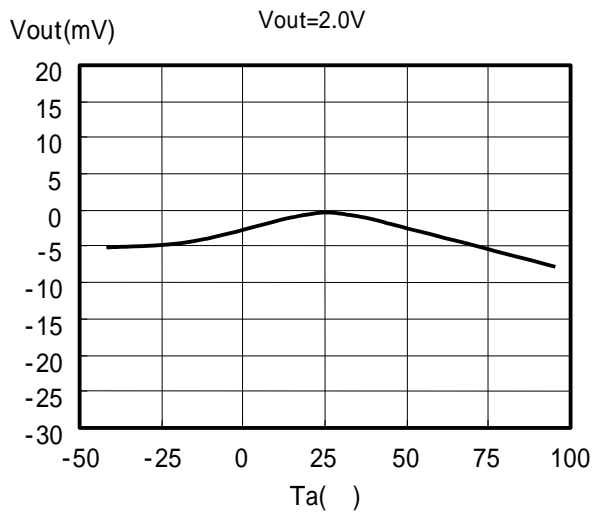

Low voltage device

The operating initial voltage at normal temperature is about 1.6V. The voltage dependency of the output current at the low input voltage is large. The operating initial voltage rises at low temperature.

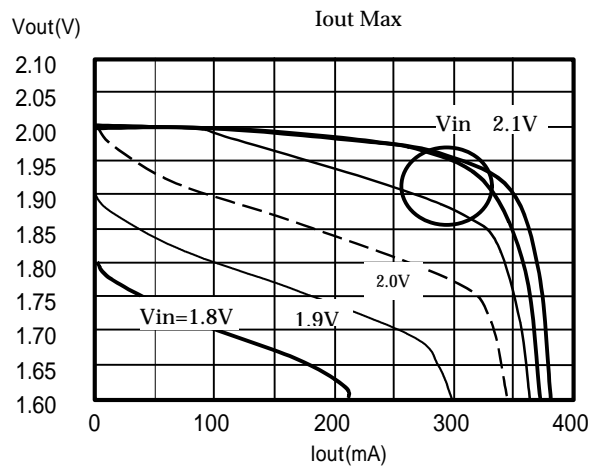
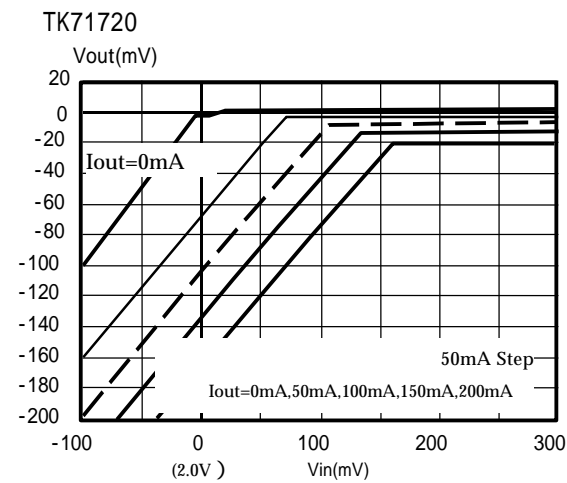
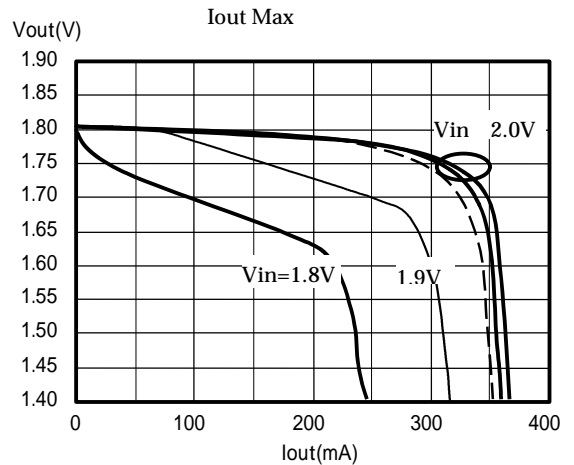
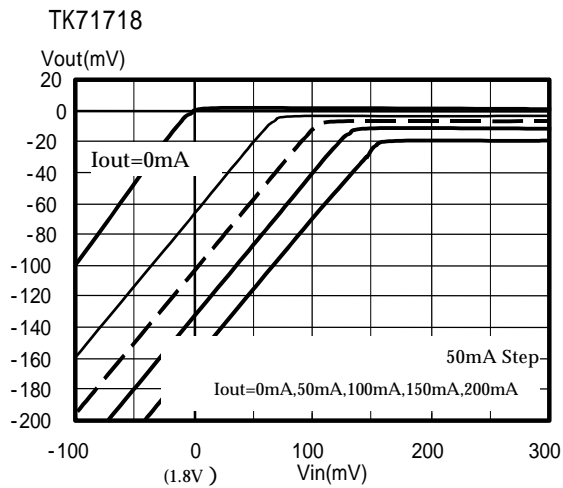
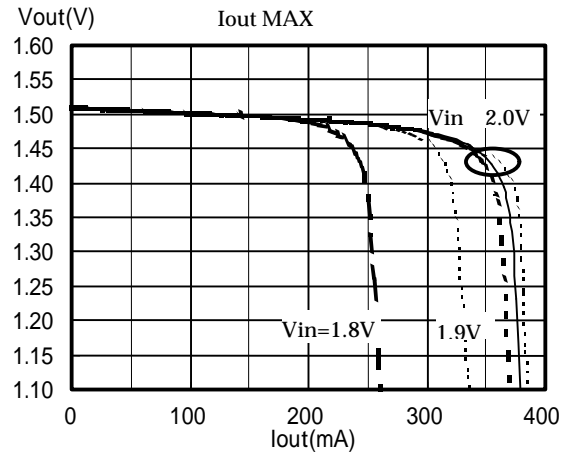
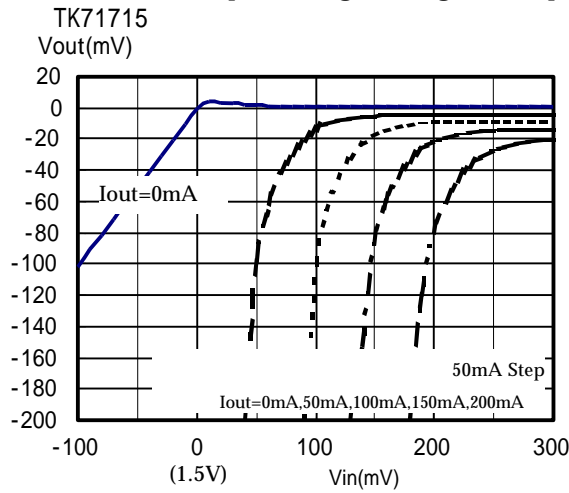

Layout Material : Grass epoxy 20 × 20mm t=0.8mm

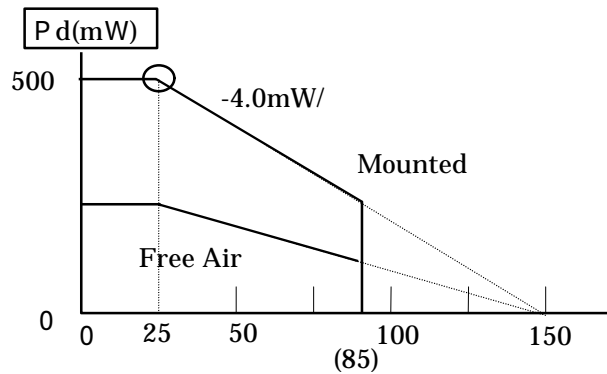
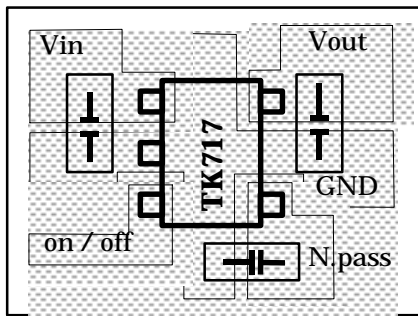

$P_d=500$ mW when mounted as recommended. Derate at 4.0 mW/°C for operation above 25°C . The thermal resistance is ($\theta_{ja}=250$ /W). The heat loss of A and B are done in total. The package loss is limited at the temperature that the internal temperature sensor works (about 150°C). Therefore, the package loss is assumed to be an internal limitation. There is no heat radiation characteristic of the package unit assumed because of the small size. Heat is carried away by the device being installed on the PCB. This value changes by the material and the copper pattern etc. of the PCB. Enduring losses of about 500mW becomes possible in a lot of applications operating at 25°C .

Determining the thermal resistance when mounted on a PCB.

The operating chip junction temperature is shown by $T_j = \theta_{ja} \times P_d + T_a$. T_j of IC is set to about 150°C . P_d is a value when the overtemperature sensor is made to work.

$$T_a (T_a=25^\circ\text{C})$$

$$150 = \theta_{ja} \times P_d + 25$$

$$\theta_{ja} \times P_d = 125$$

$$\theta_{ja} = (125 / P_d) (/ \text{mW})$$

P_d is easily obtained.

Mount the IC on the print circuit board. Short between the output pin and ground. after that, raise input voltage from 0V to evaluated voltage (see*1) gradually.

At shorted the output pin, the power dissipation P_D can be expressed as $P_d = V_{in} \times I_{in}$.

The input current decreases gradually as the temperature of the chip becomes high. After a while, it reaches the thermal equilibrium. Use this current value at the thermal equilibrium. In almost all the cases, it shows 500mW (SOT23-5) or more.

*1 In the case that the power, $V_{in} \times I_{short}$ (Short Circuit Current), becomes more than twice of the maximum rating of its power dissipation in a moment, there is a possibility that the IC is destroyed before internal thermal protection works.

P_d is obtained by the normal temperature degrees. The current that can be used at the highest operating temperature is obtained from the graph of the figure below.

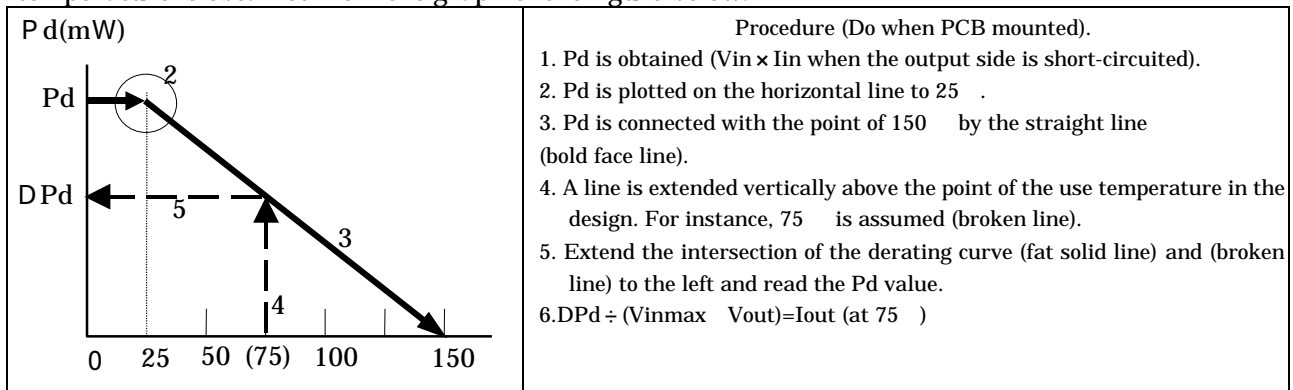

The maximum current that can be used at the highest operating temperature is:

$I_{out} = DP_d \div (V_{inmax} - V_{out})$.

When $(V_{inmax} - V_{out})$ is small, a lot of I_{out} is calculated. However, use that exceeds I_{outMax} cannot be done.

Application hint

On/off Control

It is recommended to turn the regulator Off when the circuit following the regulator is non-operating. A design with a little electric power loss can be implemented. We recommend the use of the on/off control of the regulator without using a high side switch to provide an output from the regulator. A highly accurate output voltage with low voltage drop is obtained.

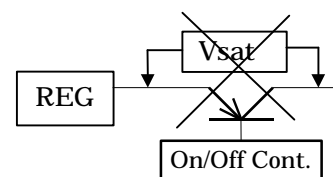
**Auto discharge circuit**

This circuit operates during off. Please do not connect the battery, the power supply, or other regulators to the output side. The charge of the output side capacitor chiefly passes through the automatic output side discharge circuit of the regulator during off.

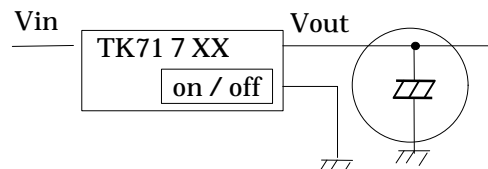

For this function

It is not possible to operate by connecting two or more regulators with different voltages to the output side of the IC.

Because the control current is small, it is possible to control it directly by CMOS logic.

The PULLDOWN resistance is not built into the control terminal.

The noise and the ripple rejection characteristics depend on the capacitance on the Vref terminal.

The ripple rejection characteristic of the low frequency region improves by increasing the capacitance of Cnp.

A standard value is $C_{np}=0.01 \mu F$. Increase C_{np} in a design with important output noise and ripple rejection requirements. The IC will not be damaged if the capacitor value is increased.

Current boost

For current boost applications, use the products below. A low voltage drop, high current regulator can be easily made.

TK714xx Only the PNP transistor for the current boost is external.

TK732XX (For $I_{out}=10A$ Max regulator)

Built-in Short circuit protection: a constant current can be set by an external resistor.

Definition of Terms

The output voltage tables are specified with a test voltage of $V_{in} = \text{output voltage Typ} + 1V$.

Output Voltage (V_{out})

The output voltage is specified with $V_{in} = \text{output voltage Typ} + 1V$ and output current ($I_{out} = 5mA$).

Maximum Output Current ($I_{out Max}$)

The output current is measured when the output voltage decreases to $(V_{out_{Typ}} \times 0.9)$. The input voltage is (output voltage Typ+1V). The maximum output current is measured in a short time so that it is not influenced by the temperature of the chip.

The output current decreases during low voltage operation.

Please refer to the "Low input voltage-output current" graph for 2.1V or less.

Dropout Voltage (V_{drop})

The dropout voltage is the difference between the input voltage and the output voltage at which point the regulator starts to fall out of regulation. Below this value, the output voltage will fall as the input voltage is reduced. It is dependent upon the load current (I_{out}) and the junction temperature (T_j).

The input voltage is gradually decreased below the test voltage. It is the voltage difference between the input and the output when the output voltage decreases by 100mV.

Line Regulation (Lin Reg)

Line regulation is the ability of the regulator to maintain a constant output voltage as the input voltage changes. The line regulation is specified as the input voltage is changed from (output voltage Typ+1V) to (output voltage Typ+6V). This measurement is not influenced by the temperature of the IC and is measured in a short time.

Load Regulation (Load Reg)

Load regulation is the ability of the regulator to maintain a constant output voltage as the load current changes. The input voltage is set to (output voltage Typ+1V). The output voltage change is measured as the load current changes from 5 to 100mA and from 5 to 200mA. This measurement is not influenced by the temperature of the IC and is measured in a short time.

Quiescent Current (I_q)

The quiescent current is the current which flows through the ground terminal under no load conditions ($I_o = 0 mA$).

Ground Pin Current (I_{gnd})

Ground pin current is the current which flows through the GND terminal according to load current. It is measured by (input current-output current).

Ripple Rejection (RR)

Ripple rejection is the ability of the regulator to attenuate the ripple content of the input voltage at the output. It is specified with the input voltage = $(V_{out} + 1.5V)$, $I_o = 10mA$, $C_L = 1.0 \mu F$ and $C_N = 0.01 \mu F$. An Alternating Current source of ($f = 1KHz$ and $200mV_{RMS}$) is superimposed to the power-supply voltage. Ripple rejection is the ratio of the ripple content of the output vs. the input and is expressed in dB. It is typically about 80dB at 1kHz. The ripple rejection improves when the value of the capacitor at the noise bypass terminal in the circuit is large. However, the on/off response worsens.

Standby Current

Standby current is the current which flows into the regulator when the control voltage is made 0 volts. It is measured with an input voltage of 8V.

PROTECTION CIRCUITS**Short circuit Sensor**

This sensor operates when there is excessive output current. The short circuit sensor protects the device if the output is accidentally shorted to GND. The current flows at the set peak value.

Thermal Sensor

The thermal sensor protects the device if the junction temperature exceeds the safe value ($T_j = 150^\circ\text{C}$). This temperature rise can be caused by extreme heat, excessive power dissipation caused by large output voltage drops, or excessive output current. The regulator will shut off when the temperature exceeds the safe value. As the junction temperature decreases, the regulator will begin to operate again. Under sustained fault conditions, the regulator output will oscillate as the device turns off then resets. Please improve heat radiation or lower the input electric power. When heat radiation is poor, the forecast package loss is not obtained.

* In the case that the power, $V_{in} \times I_{short}$ (Short Circuit Current), becomes more than twice of the maximum rating of its power dissipation in a moment, there is a possibility that the IC is destroyed before internal thermal protection works.

ESD	MM	200pF	0	200V Min
	HBM	100pF	1.5k	2000V Min

Outline ; PCB ; Stamps

SOT23-5

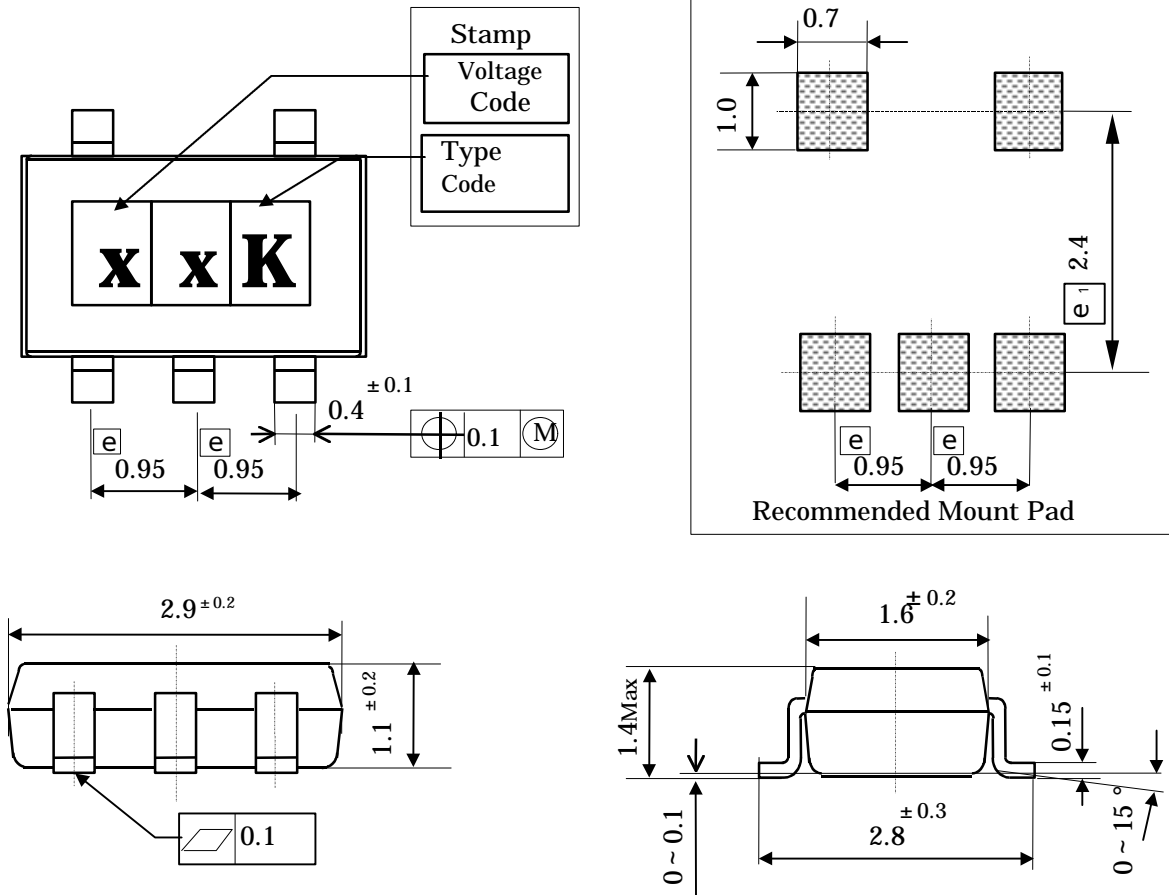

Unit : mm
 General tolerance : ± 0.2

Molded Resin with Body : Epoxy Resin
 Lead Frame : Copper Alloy
 Treatment : Solder Plating(5 ~ 15 μ m)
 Marking Method : Ink or Laser
 Weight : 0.016g
 Country of origin : Japan or Korea

V OUT	V CODE	V OUT	V CODE	V OUT	V CODE	V OUT	V CODE
1.5 v	15	2.5 v	25	3.5 v	35	4.5 v	45
1.6	16	2.6	26	3.6	36	4.6	46
1.7	17	2.7	27	3.7	37	4.7	47
1.8	18	2.8	28	3.8	38	4.8	48
1.9	19	2.9	29	3.9	39	4.9	49
2.0	20	3.0	30	4.0	40	5.0	50
2.1	21	3.1	31	4.1	41		
2.2	22	3.2	32	4.2	42		
2.3	23	3.3	33	4.3	43		
2.4	24	3.4	34	4.4	44		

The output voltage table indicates the standard value when manufactured.

NOTE

Please be sure that you carefully discuss your planned purchase with our office if you intend to use the products in this data sheet under conditions where particularly extreme standards of reliability are required, or if you intend to use products for applications other than those listed in this data sheet.

- Power drive products for automobile, ship or aircraft transport systems; steering and navigation systems, emergency signal communications systems, and any system other than those mentioned above which include electronic sensors, measuring, or display devices, and which could cause major damage to life, limb or property if misused or failure to function.
 - Medical devices for measuring blood pressure, pulse, etc., treatment units such as coronary pacemakers and heat treatment units, and devices such as artificial organs and artificial limb systems which augment physiological functions.
 - Electrical instruments, equipment or systems used in disaster or crime prevention.
- Semiconductors, by nature, may fail or malfunction in spite of our devotion to improve product quality and reliability. We urge you to take every possible precaution against physical injuries, fire or other damages which may cause failure of our semiconductor products by taking appropriate measures, including a reasonable safety margin, malfunction preventive practices and fire-proofing when designing your products.
- This data sheet is effective from **Oct. 2002**. Note that the contents are subject to change or discontinuation without notice. When placing orders, please confirm specifications and delivery condition in writing.
- TOKO is not responsible for any problems nor for any infringement of third party patents or any other intellectual property rights that may arise from the use or method of use of the products listed in this data sheet. Moreover, this data sheet does not signify that TOKO agrees implicitly or explicitly to license any patent rights or other intellectual property rights which it holds.
- None of ozone depleting substances(ODS) under the Montreal Protocol is used in manufacturing process of us.

If you need more information on this product and other TOKO products, please contact us.

OFFICE

■ TOKO Inc. Headquarters

1-17, Higashi-yukigaya 2-chome, Ohta-ku, Tokyo, 145-8585, Japan

TEL: +81.3.3727.1161

FAX: +81.3.3727.1176 or +81.3.3727.1169

Web site: <http://www.toko.co.jp/>

■ TOKO America

Web site: <http://www.toko.com/>

■ TOKO Europe

Web site: <http://www.tokoeurope.com/>

■ TOKO Hong Kong

Web site: <http://www.toko.com.hk/>

■ TOKO Taiwan

Web site: <http://www.tokohc.com.tw/>

■ TOKO Singapore

Web site: <http://www.toko.com.sg/>

■ TOKO Seoul

Web site: <http://www.toko.co.kr/>

■ TOKO Manila

Web site: <http://www.toko.com.ph/>

■ TOKO Brazil

Web site: <http://www.toko.com.br/>



TO BUILD THE QUALITY RELIED BY COSTOMERS

Semiconductor Division

YOUR DISTRIBUTOR