

# HEXPAK POWER MODULE

## IRFK2D150

## IRFK2D151



### Isolated Base Power HEXFET® Assembly Half Bridge Configuration

#### 100 Volt, 28 mΩ HEXPAK

The HEXFET® technology is the key to International Rectifier's advanced line of power MOSFET transistors. The efficient geometry and unique processing of the HEXFET design achieve very low on-state resistance combined with high transconductance and extreme device ruggedness.

The superior HEXFET technology has been coupled to the state of the art assembling techniques adopted for all International Rectifier isolated base modules. This multiple die package is ideally suited for high power applications where space saving and ease of assembling is important. Applications include uninterruptible power supplies, motor drive controls, switching power supplies, and high frequency welders.

#### Features:

- High Current Capability
- Fast Switching
- Low Drive Current
- No Second Breakdown
- Ease of Paralleling
- Electrically Isolated Base Plate

#### Product Summary

Part Number	V <sub>DS</sub>	R <sub>DS(on)</sub>	I <sub>D</sub>
IRFK2D150	100V	28 mΩ	72A
IRFK2D151	60V	28 mΩ	72A

MODULE DEVICES

#### CASE STYLE AND DIMENSIONS

32 (3.62)  
60 (3.14)  
6 (0.23)  
20 (0.78)  
2 HOLES Ø6.5 (0.26)  
21.5 (0.85) 20 (0.78) 20 (0.78) 17.5 (0.69) M5 SCREW  
37 (1.46) MAX. 30 (1.18) 32 (1.25)  
6 (0.23)  
2.8 x 0.8 (0.11 x 0.03) FASTON TAB. WITH HOLE Ø1.2 (0.04)  
SUPPLIED WITH AUX-LEADS 305 (12.0) Lg.

Similar to JEDEC Outline TO-240AA  
Dimensions in Millimeters (Inches)

**Absolute Maximum Ratings**

Parameter	IRFK2D150	IRFK2D151	Units
V <sub>DS</sub> Drain-Source Voltage ①	100	60	V
V <sub>DGR</sub> Drain-Gate Voltage (R <sub>GS</sub> = 10 kΩ) ①	100	60	V
I <sub>D</sub> @ T <sub>C</sub> = 25°C Continuous Drain Current	72	72	A
I <sub>D</sub> @ T <sub>C</sub> = 100°C Continuous Drain Current	45	45	A
I <sub>DM</sub> Pulsed Drain Current	250	250	A
V <sub>GS</sub> Gate-Source Voltage	20	20	V
P <sub>D</sub> @ T <sub>C</sub> = 25°C Max. Power Dissipation	500	500	W
Linear Derating Factor	4	4	W/K
I <sub>LM</sub> Inductive Current, Clamped	250	250	A
T <sub>J</sub> T <sub>stg</sub> Operating Junction and Storage Temperature Range	-55 to 150		°C
di/dt Max. Rate of Change of Current at Turn Off	See Fig. 15		A/μs

**Electrical Characteristics @ T<sub>C</sub> = 25°C (Unless Otherwise Specified)**

Parameter	Type	Min.	Typ.	Max.	Units	Test Conditions
BV <sub>DSS</sub> Drain-Source Breakdown Voltage	IRFK2D150 IRFK2D151	100 60	— —	— —	V V	V <sub>GS</sub> = 0V, I <sub>D</sub> = 500 μA
V <sub>GS(th)</sub> Gate Threshold Voltage	ALL	2.0	—	4.0	V	V <sub>DS</sub> = V <sub>GS</sub> , I <sub>D</sub> = 500 μA
I <sub>GSS</sub> Gate-Source Leakage Forward	ALL	—	—	200	nA	V <sub>GS</sub> = 20V
I <sub>GSS</sub> Gate-Source Leakage Reverse	ALL	—	—	-200	nA	V <sub>GS</sub> = -20V
I <sub>DSS</sub> Zero Gate Voltage Drain Current	ALL	—	—	500	μA	V <sub>DS</sub> = V <sub>DSS</sub> Max., V <sub>GS</sub> = 0V
R <sub>DS(on)</sub> Static Drain-Source On-State Resistance	ALL	—	23	28	mΩ	V <sub>DS</sub> = V <sub>DSS</sub> Max. × 0.8, V <sub>GS</sub> = 0V, T <sub>C</sub> = 125°C
g <sub>fs</sub> Forward Transconductance	ALL	18	22	—	S(Ω)	V <sub>GS</sub> = 10V, I <sub>D</sub> = 40A
C <sub>iss</sub> Input Capacitance	ALL	—	4.0	6.0	nF	V <sub>GS</sub> = 0V, V <sub>DS</sub> = 25V, f = 1.0 MHz
C <sub>oss</sub> Output Capacitance	ALL	—	2.0	3.0	nF	
C <sub>rss</sub> Reverse Transfer Capacitance	ALL	—	700	1000	pF	
t <sub>d(on)</sub> Turn-On Delay Time	ALL	—	—	45	ns	V <sub>DD</sub> = 24V, I <sub>D</sub> = 25A, V <sub>GS</sub> = 10V, R <sub>Source</sub> = 3.3Ω
t <sub>r</sub> Rise Time	ALL	—	—	200	ns	
t <sub>d(off)</sub> Turn-Off Delay Time	ALL	—	—	160	ns	
t <sub>f</sub> Fall Time	ALL	—	—	140	ns	
Q <sub>g</sub> Total Gate Charge (Gate-Source Plus Gate-Drain)	ALL	—	125	240	nC	
Q <sub>gs</sub> Gate-Source Charge	ALL	—	55	—	nC	
Q <sub>gd</sub> Gate-Drain ("Miller") Charge	ALL	—	70	—	nC	
V <sub>INS</sub> Isolation Voltage	ALL	2.5	—	—	kV	Circuit to Base
L <sub>DS</sub> Drain-Source Inductance	ALL	—	18	—	nH	

**Thermal and Mechanical Specifications**

R <sub>thJC</sub> Junction-to-Case	ALL	—	—	0.25	K/W	Per module
R <sub>thCS</sub> Case-to-Sink	ALL	—	—	0.1	K/W	Mounting surface flat, smooth, and greased
T Mounting torque + 10% HEXPAK to heatsink	ALL	—	—	5	Nm	A mounting compound is recommended and the torque should be rechecked after a period of about 3 hours to allow for the spread of the compound.
Busbar to HEXPAK	ALL	—	—	3	Nm	
wt Approximate weight	ALL	—	—	140 5	g oz	

**Source-Drain Diode Ratings and Characteristics**

I <sub>S</sub> Continuous Source Current (Body Diode)	ALL	—	—	72	A	T <sub>C</sub> = 25°C, I <sub>S</sub> = 80A, V <sub>GS</sub> = 0V
I <sub>SM</sub> Pulse Source Current (Body Diode)	ALL	—	—	250	A	
V <sub>SD</sub> Diode Forward Voltage	ALL	—	—	2.5	V	T <sub>J</sub> = 150°C, I <sub>F</sub> = 80A, di <sub>F</sub> /dt = 100A/μs
t <sub>rr</sub> Reverse Recovery Time	ALL	—	—	600	ns	
Q <sub>RR</sub> Reverse Recovered Charge	ALL	—	—	6.6	μC	

① T<sub>J</sub> = 25°C to 150°C

INTERNATIONAL RECTIFIER

T-39-27

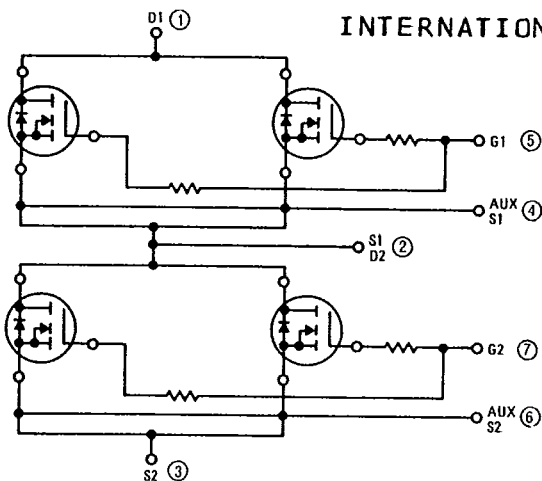

Fig. a - Circuit Configuration

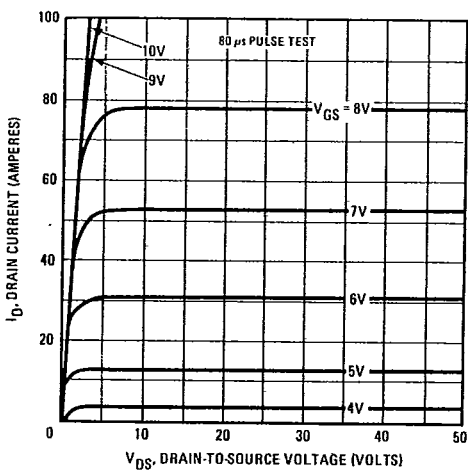

Fig. 1 - Typical Output Characteristics

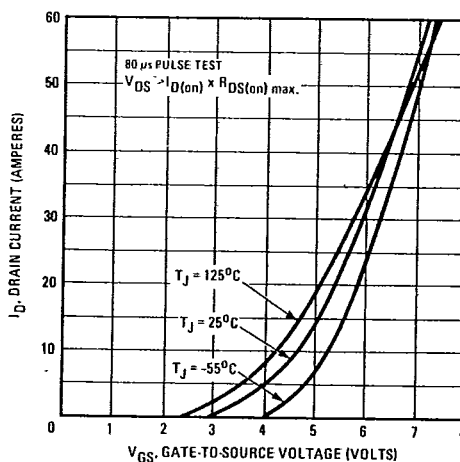

Fig. 2 - Typical Transfer Characteristics

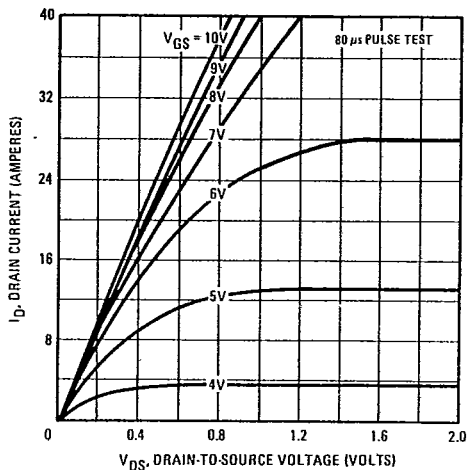

Fig. 3 - Typical Saturation Characteristics

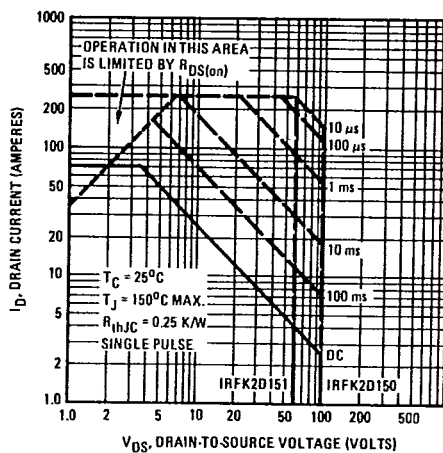

Fig. 4 - Maximum Safe Operating Area (Per Arm)

MODULE  
DEVICES

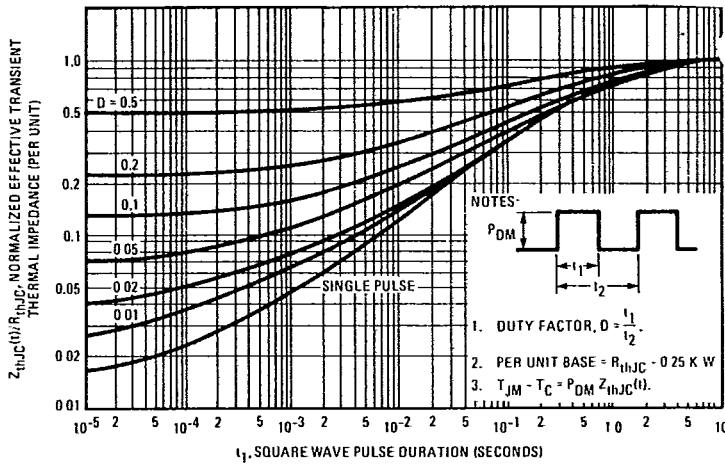

Fig. 5 - Maximum Effective Transient Thermal Impedance Junction-to-Case Vs. Pulse Duration

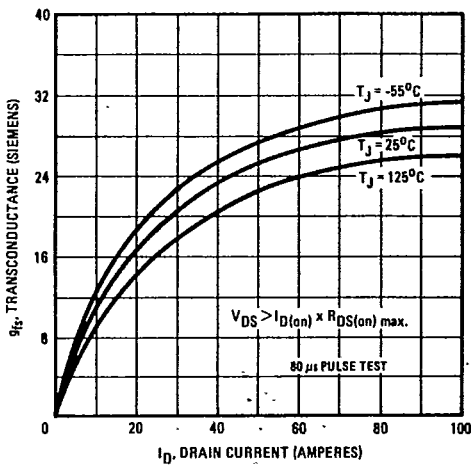

Fig. 6 - Typical Transconductance Vs. Drain Current

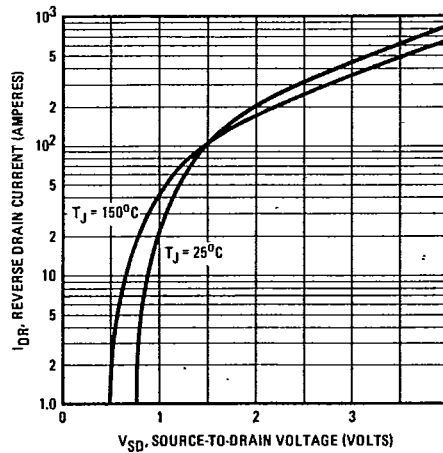

Fig. 7 - Typical Source-Drain Diode Forward Voltage

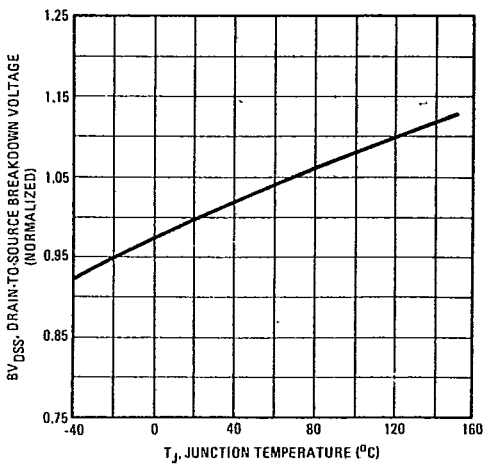

Fig. 8 - Breakdown Voltage Vs. Temperature

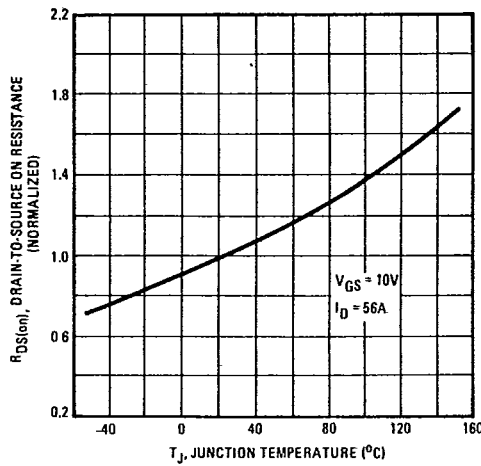

Fig. 9 - Normalized On-Resistance Vs. Temperature

INTERNATIONAL RECTIFIER

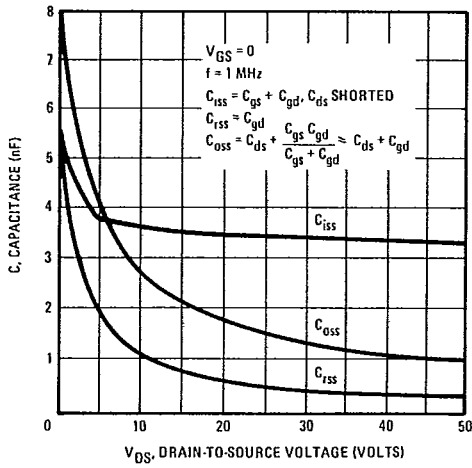

Fig. 10 - Typical Capacitance Vs. Drain-to-Source Voltage

IRFK2D150, IRFK2D151 Devices

T-39-27

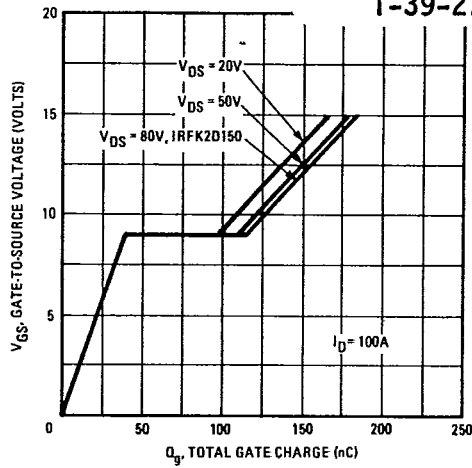

Fig. 11 - Typical Gate Charge Vs. Gate-to-Source Voltage

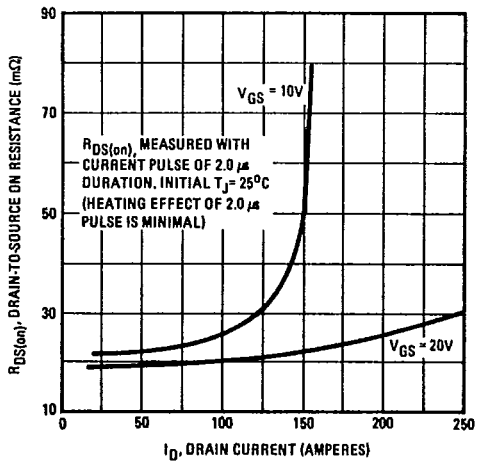

Fig. 12 - Typical On-Resistance Vs. Drain Current

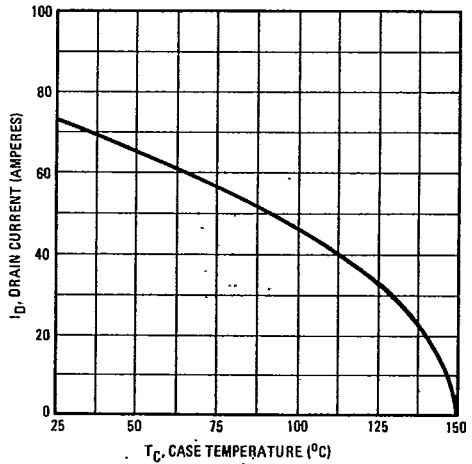

Fig. 13 - Maximum Drain Current Vs. Case Temperature

MODULE DEVICES

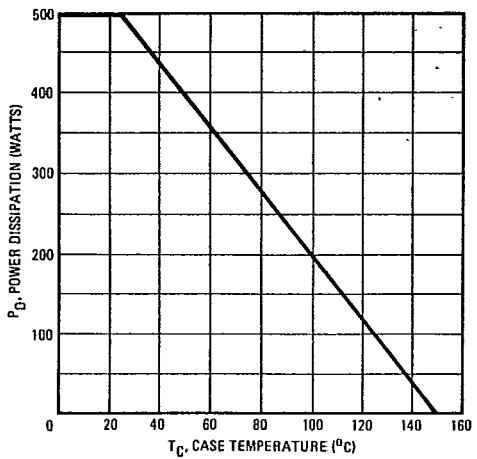

Fig. 14 - Power Vs. Temperature Derating Curve

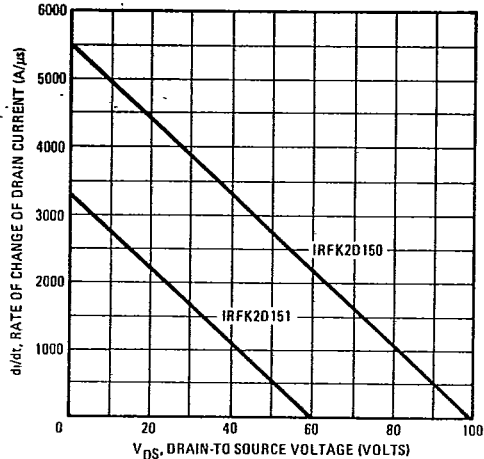

Fig. 15 - Maximum Rate of Change of Drain Current Vs. Drain-to-Source Voltage

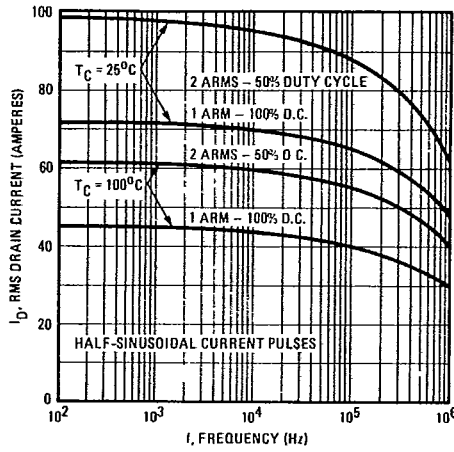

Fig. 16 – Maximum Continuous Drain Current Vs. Frequency Derating

### The Do's and Don'ts of Using HEXPAK Power Modules

We can summarize some of the most common recommendations on using HEXPAK Power Modules as follows:

- a) Observe mounting recommendations for optimum thermal performance and enhanced reliability during operation.
- b) Keep the length of the leads to the auxiliary terminals as short as possible. **DO NOT USE THE SOURCE POWER CONNECTORS** for gate circuit return connections, **USE THE AUXILIARY SOURCE CONNECTOR.**
- c) Maintain turn-off drive circuit impedances as low as possible. It is even more desirable to use gate-source reverse biasing in high dv/dt environments.
- d) Use gate zener clamps.
- e) Pay attention to the di/dt vs  $V_{DS}$  curve in the data.
- f) Make due allowances for drain current in high frequency applications. Refer to *Figure 16*.
- g) Ensure good layout practice is adhered to in the design of the power circuit to minimize undesirable perturbations and interference.
- h) Always decouple the power circuit locally.
- i) Ensure turn-off snubbers are in close proximity with the power terminals.
- j) Do not use principles of false economy in selection of decoupling and snubber components.

Almost all of the precautions advised above are fundamental. Observation of these few precautions on the other hand will ensure long and trouble-free operation of the circuit. Of greater significance, adherence to these few precautions is rewarded by the enhanced design-in simplicity offered by these power modules.



**CAUTION**  
**SENSITIVE ELECTRONIC DEVICES**  
 DO NOT SHIP OR STORE NEAR STRONG ELECTROSTATIC,  
 ELECTROMAGNETIC OR RADIOACTIVE FIELDS.  
**INTERNATIONAL RECTIFIER**  
*... because your company cares.*