

XC6206 Series

ETR0305_002

Low ESR Cap.Compatible Positive Voltage Regulators

GENERAL DESCRIPTION

The XC6206 series are highly precise, low power consumption, high voltage, positive voltage regulators manufactured using CMOS and laser trimming technologies. The series provides large currents with a significantly small dropout voltage.

The XC6206 consists of a current limiter circuit, a driver transistor, a precision reference voltage and an error correction circuit. The series is compatible with low ESR ceramic capacitors. The current limiter's foldback circuit also operates as a short protect for the output current limiter and the output pin.

Output voltage can be set internally by laser trimming technologies. It is selectable in 0.1V increments within a range of 1.2V to 5.0V.

SOT-23, SOT-89, TO-92 and USP-6B packages are available.

APPLICATIONS

- Battery powered equipment
- Reference voltage sources
- Cameras, video cameras
- Portable AV systems
- Mobile phones
- Portable games
- Cordless phones,
wireless communication equipment

FEATURES

CMOS

Maximum Output Current	: 250mA (5.0V type)
Dropout Voltage	: 250mV @ 100mA (3.0V type)
Maximum Operating Voltage	: 6.0V
Output Voltage Range	: 1.2V ~ 5.0V (0.1V increments)
Highly Accurate	: Fixed voltage accuracy $\pm 2\%$ ($\pm 30\text{mV}@V_{\text{OUT}} < 1.5\text{V}$) ($\pm 1\% @ V_{\text{OUT}} \geq 2.0\text{V}$)
Low Power Consumption	: 1.0 μA (TYP.)
Operating Temperature Range	: $-40^{\circ}\text{C} \sim 85^{\circ}\text{C}$
Low ESR Capacitor	: Ceramic capacitor compatible
Current Limit Circuit Built-in	
Ultra Small Package	: SOT-23 (250mW) SOT-89 (500mW) TO-92 (300mW) USP-6B (100mW)

TYPICAL APPLICATION CIRCUIT

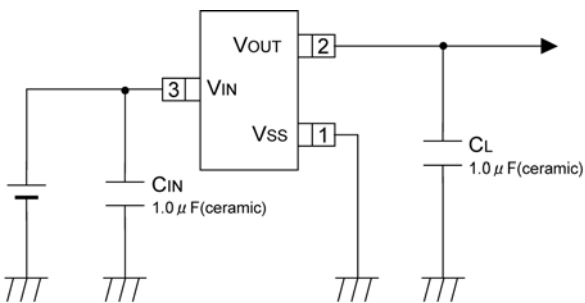

TYPICAL PERFORMANCE CHARACTERISTICS

XC6206P302

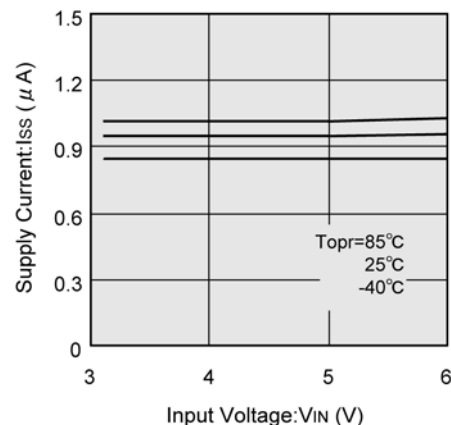

PIN CONFIGURATION

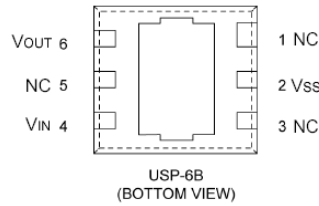
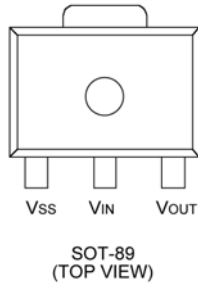
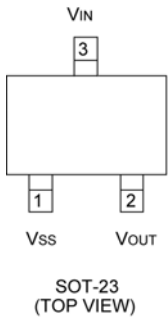

*The dissipation pad for the USP-6B package should be solder-plated in recommended mount pattern and metal masking so as to enhance mounting strength and heat release. If the pad needs to be connected to other pins, it should be connected to the pin number 4 (V_{IN}).

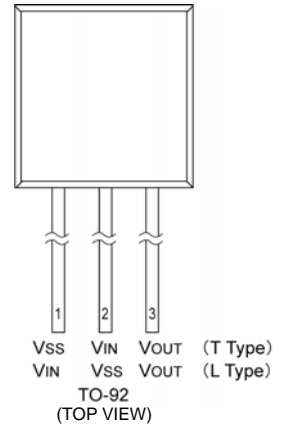

PIN ASSIGNMENT

PIN NUMBER				PIN NAME	FUNCTIONS
SOT-23	SOT-89/TO-92 (T)	USP-6B	TO-92 (L)		
1	1	2	2	Vss	Ground
3	2	4	1	VIN	Power Input
2	3	6	3	VOUT	Output
-	-	1, 3, 5	-	NC	No Connection

PRODUCT CLASSIFICATION

Ordering Information

XC6206P

DESIGNATOR	DESCRIPTION	SYMBOL	DESCRIPTION
	Output Voltage	12~50	: e.g. VOUT: 3.0V =3, =0
	Accuracy	2	: Within $\pm 2\%$ (within $\pm 30\text{mV}$ when $V_{OUT} < 1.5\text{V}$)
		1 *	: Within $\pm 1\%$
	Packages	M	: SOT-23
		P	: SOT-89
		D	: USP-6B
		T	: TO-92 (T type)
		L	: TO-92 (L type) (Discontinued Product)
	Device Orientation	R	: Embossed tape, standard feed
		L	: Embossed tape, reverse feed
		H	: Page type (TO-92)
		B	: Bag (TO-92)

* $\pm 1\%$ accuracy can be set at $V_{OUT(T)} \geq 2.0\text{V}$.

BLOCK DIAGRAM

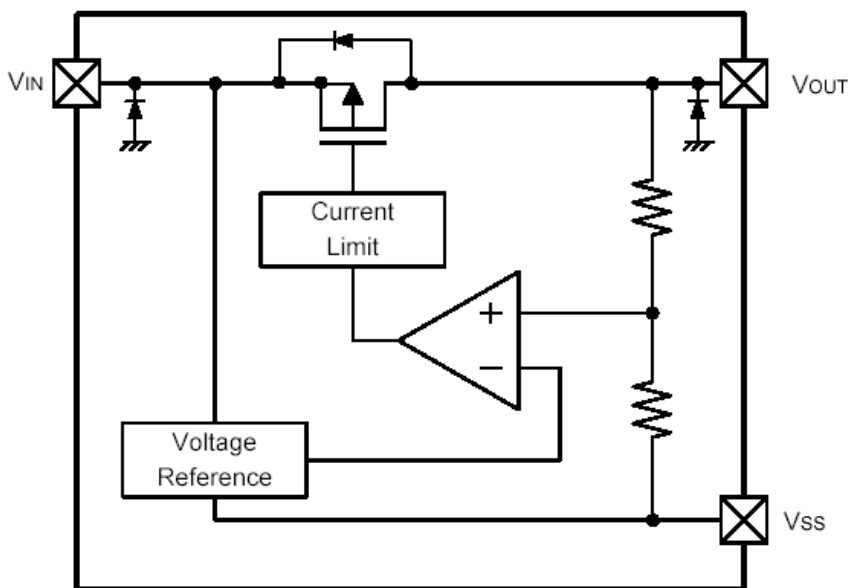

*Diodes inside the circuit are an ESD protection diode and a parasitic diode.

ABSOLUTE MAXIMUM RATINGS

Ta=25°C

PARAMETER	SYMBOL	RATINGS	UNITS
Input Voltage	V _{IN}	7.0	V
Output Current	I _{OUT}	500 *	mA
Output Voltage	V _{OUT}	V _{SS} - 0.3 ~ V _{IN} + 0.3	V
Power Dissipation	SOT-23	250	mW
	SOT-89	500	
	USP-6B	100	
	TO-92	300	
Operating Temperature Range	T _{opr}	- 40 ~ + 85	°C
Storage Temperature Range	T _{stg}	- 55 ~ + 125	°C

* I_{OUT}=P_d / (V_{IN}-V_{OUT})

ELECTRICAL CHARACTERISTICS

XC6206P series

Ta=25 °C

PARAMETER	SYMBOL	CONDITIONS	MIN.	TYP.	MAX.	UNITS	CIRCUIT
Output Voltage ^{(*)7}	V _{OUT(E)} ^{(*)2}	I _{OUT} =30mA	x 0.98	V _{OUT(T)}	x 1.02	V	
			E-1				
Maximum Output Current	I _{OUTMAX}	-	E-2	-	-	mA	
Load Regulation	V _{OUT}	V _{OUT(T)} >1.8V: 1mA I _{OUT} 100mA V _{OUT(T)} ≤1.8V: 1mA I _{OUT} 50mA	-	-	E-3	mV	
Dropout Voltage	V _{dif1}	I _{OUT} =30mA	-	E-4		mV	
	V _{dif2}	V _{OUT(T)} >1.8V: I _{OUT} =100mA V _{OUT(T)} ≤1.8V: I _{OUT} =60mA	-	E-5		mV	
Supply Current	I _{DD}	V _{CE} =V _{IN}	-	1.0	3.0	μA	
Line Regulation	$\frac{V_{OUT}}{V_{IN} \cdot V_{OUT}}$	V _{OUT(T)} <4.5V: V _{OUT(T)} +1.0V V _{IN} 6.0V V _{OUT(T)} ≥4.5V: 5.5V V _{IN} 6.0V I _{OUT} =30mA	-	0.05	0.25	%/V	
Input Voltage	V _{IN}	-	1.8	-	6.0	V	-
Output Voltage Temperature Characteristics	$\frac{V_{OUT}}{Topr \cdot V_{OUT}}$	I _{OUT} =30mA -40 °C Topr 85 °C	-	±100	-	ppm/°C	
Short Circuit Current	I _{short}	V _{IN} =V _{OUT} +1.5V, V _{OUT} =V _{SS}	-	E-6	-	mA	

NOTE:

* 1 : V_{OUT(T)} = Specified output voltage

* 2 : V_{OUT(E)} = Effective output voltage (I.e. The output voltage when "V_{OUT(T)}+1.0V" is provided at the V_{IN} pin while maintaining a certain I_{OUT} value.)

* 3 : V_{dif} = {V_{IN} 1^{(*)5} - V_{OUT} 1^{(*)4} }

* 4 : V_{OUT1} = A voltage equal to 98% of the output voltage whenever an amply stabilized I_{OUT} {V_{OUT(T)} + 1.0V} is input.

* 5 : V_{IN1} = The input voltage when V_{OUT1} appears as input voltage is gradually decreased.

* 6 : Unless otherwise stated, V_{IN} = V_{OUT(T)} + 1.0V

* 7 : When V_{OUT(T)}≥1.5V, accuracy is ±2%.

When V_{OUT(T)}<1.5V, accuracy is MIN.:V_{OUT(T)} -30mV / MAX.:V_{OUT(T)} +30mV

±1% accuracy (MIN.: V_{OUT(T)} x 0.99 / MAX.:V_{OUT(T)} x 1.01) is set at V_{OUT(T)}≥2.0V

ELECTRICAL CHARACTERISTICS (Continued)

Electrical Characteristics Chart

PARAMETER SETTING VOLTAGE	E-1				E-2	E-3	E-4		E-5		E-6
	OUTPUT VOLTAGE				MAX. OUTPUT CURRENT	LOAD REGULATION	DROPOUT VOLTAGE 1		DROPOUT VOLTAGE 2		SHORT CURRENT
	2% ACCURACY		1% ACCURACY				Vdif1 (mV)	Vdif2 (mV)			
VOUT(T)	VOUT(E) (V)		VOUT(E) (V)		IOUTMAX (mA)	ΔVOUT (mV)	Vdif1 (mV)		Vdif2 (mV)		Ishort (mA)
	MIN.	MAX.	MIN.	MAX.	MIN.	MAX.	TYP.	MAX.	TYP.	MAX.	TYP.
1.2	1.170	1.230	Not Available		60	40	460	760	700	960	180
1.3	1.270	1.330					400	650			
1.4	1.370	1.430					350	590			
1.5	1.470	1.530					300	510			
1.6	1.568	1.632			80	45	250	450	450	810	155
1.7	1.666	1.734					200	410			
1.8	1.764	1.836					150	390	780	130	
1.9	1.862	1.938					120	50			
2.0	1.960	2.040	1.980	2.020							
2.1	2.058	2.042	2.079	2.121							
2.2	2.156	2.244	2.178	2.222							
2.3	2.254	2.346	2.277	2.323	710	100					
2.4	2.352	2.448	2.376	2.424							
2.5	2.450	2.550	2.475	2.525							
2.6	2.548	2.652	2.574	2.626							
2.7	2.646	2.754	2.673	2.727	150	55	250	680			
2.8	2.744	2.856	2.772	2.828							
2.9	2.842	2.958	2.871	2.929							
3.0	2.940	3.060	2.970	3.030							
3.1	3.038	3.162	3.069	3.131	200	60	75	350	200	630	
3.2	3.136	3.264	3.168	3.232							
3.3	3.234	3.366	3.267	3.333							
3.4	3.332	3.468	3.366	3.434							
3.5	3.430	3.570	3.465	3.535	65	70	60	320	175	600	
3.6	3.528	3.672	3.564	3.636							
3.7	3.626	3.774	3.663	3.737							
3.8	3.724	3.876	3.762	3.838							
3.9	3.822	3.978	3.861	3.939	250	75	50	290	175	600	
4.0	3.920	4.080	3.960	4.040							
4.1	4.018	4.182	4.059	4.141							
4.2	4.116	4.284	4.158	4.242							
4.3	4.214	4.386	4.257	4.343	80	50	290	175	600		
4.4	4.312	4.488	4.356	4.444							
4.5	4.410	4.590	4.455	4.545							
4.6	4.508	4.692	4.554	4.646							
4.7	4.606	4.794	4.653	4.747	75	50	290	175	600		
4.8	4.704	4.896	4.752	4.848							
4.9	4.802	4.998	4.851	4.949							
5.0	4.900	5.100	4.950	5.050							

TEST CIRCUITS

Circuit

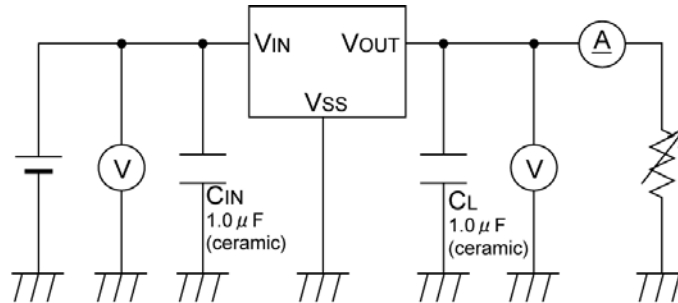

Circuit

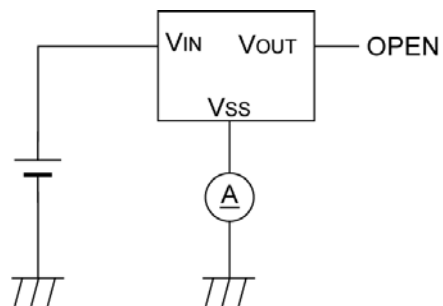

TYPICAL PERFORMANCE CHARACTERISTICS

(1) Output Voltage vs. Output Current

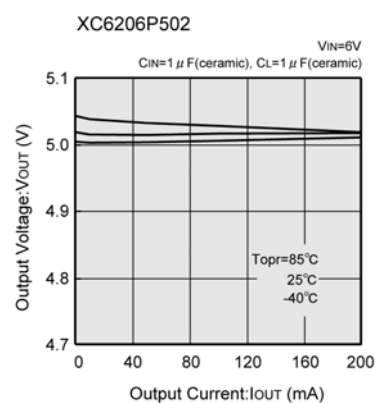
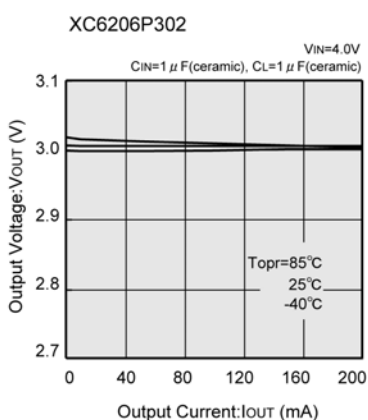
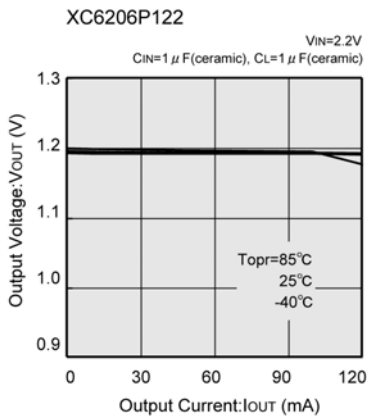

(2) Current Limit

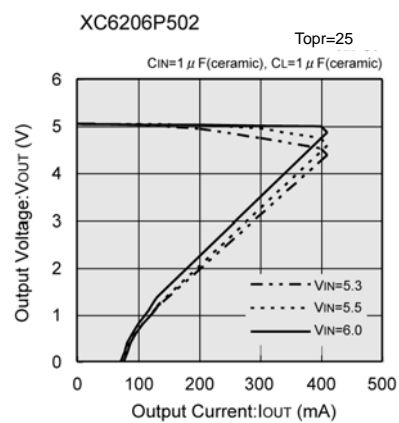
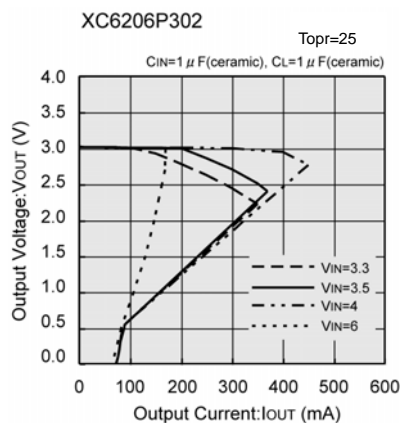
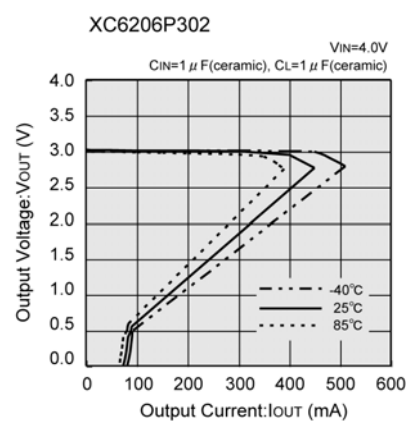
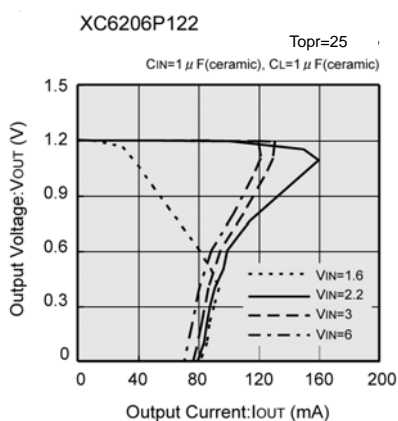
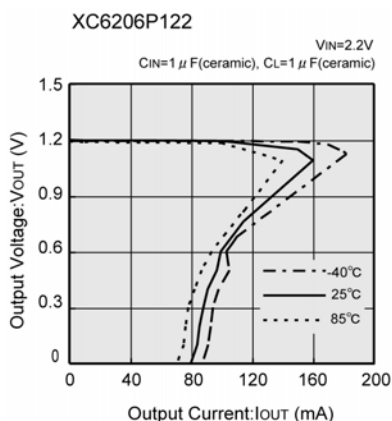

TYPICAL PERFORMANCE CHARACTERISTICS (Continued)

(3) Output Voltage vs. Input Voltage

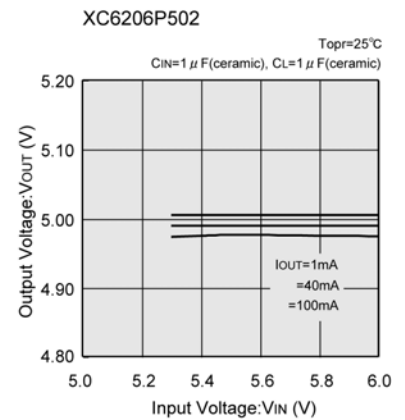
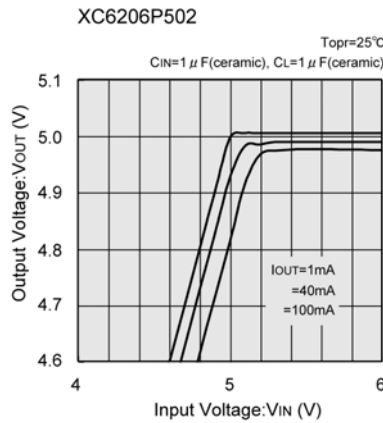
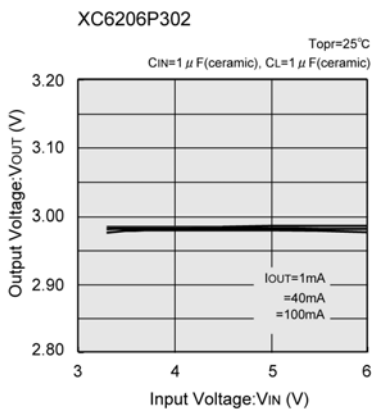
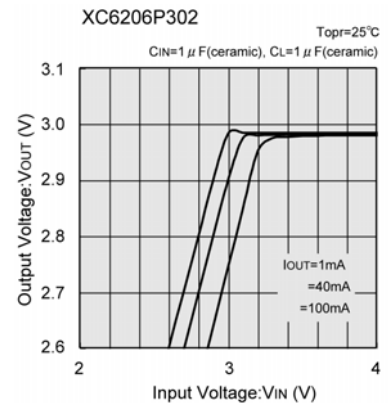
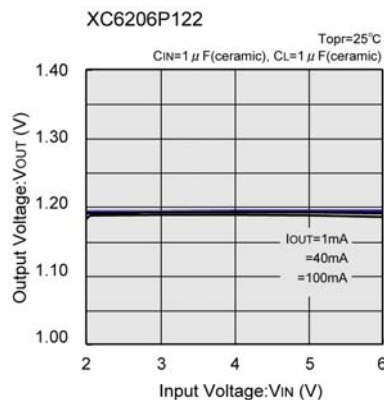
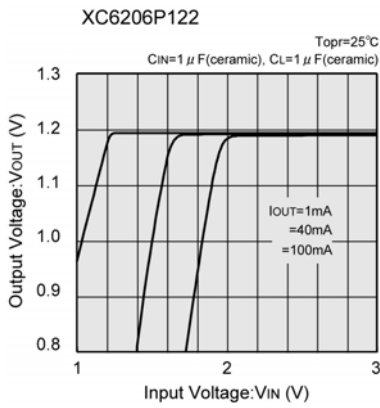

(4) Dropout Voltage vs. Output Current

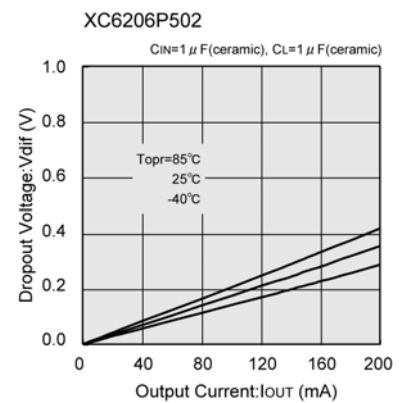
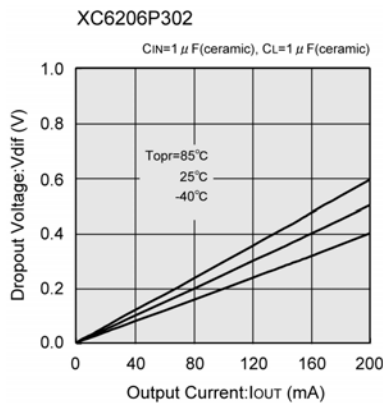
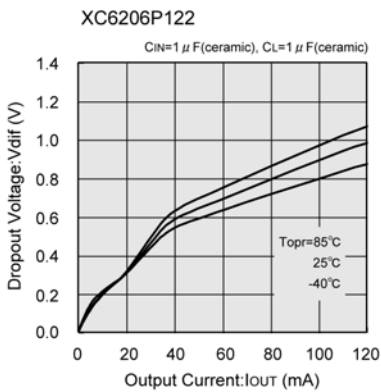

TYPICAL PERFORMANCE CHARACTERISTICS (Continued)

(5) Supply Current vs. Input Voltage

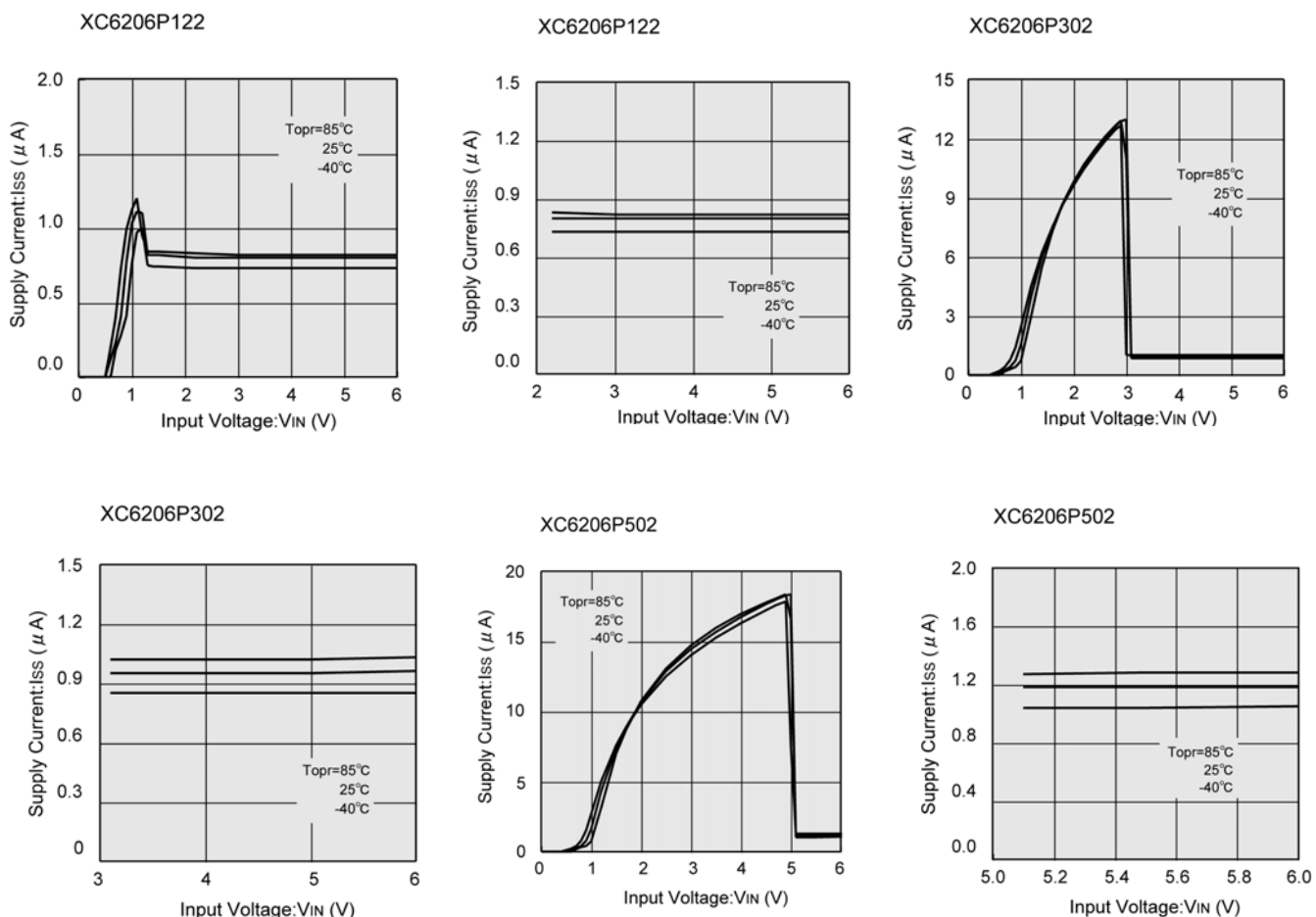

(6) Output Voltage vs. Ambient Temperature



TYPICAL PERFORMANCE CHARACTERISTICS (Continued)

(7) Output Voltage vs. Ambient Temperature

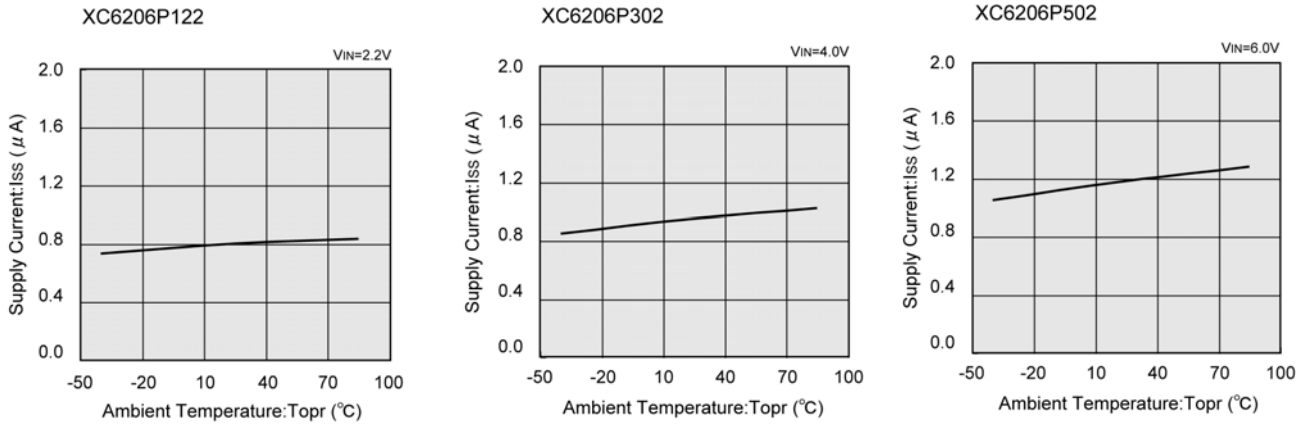

(8) Input Transient Response 1

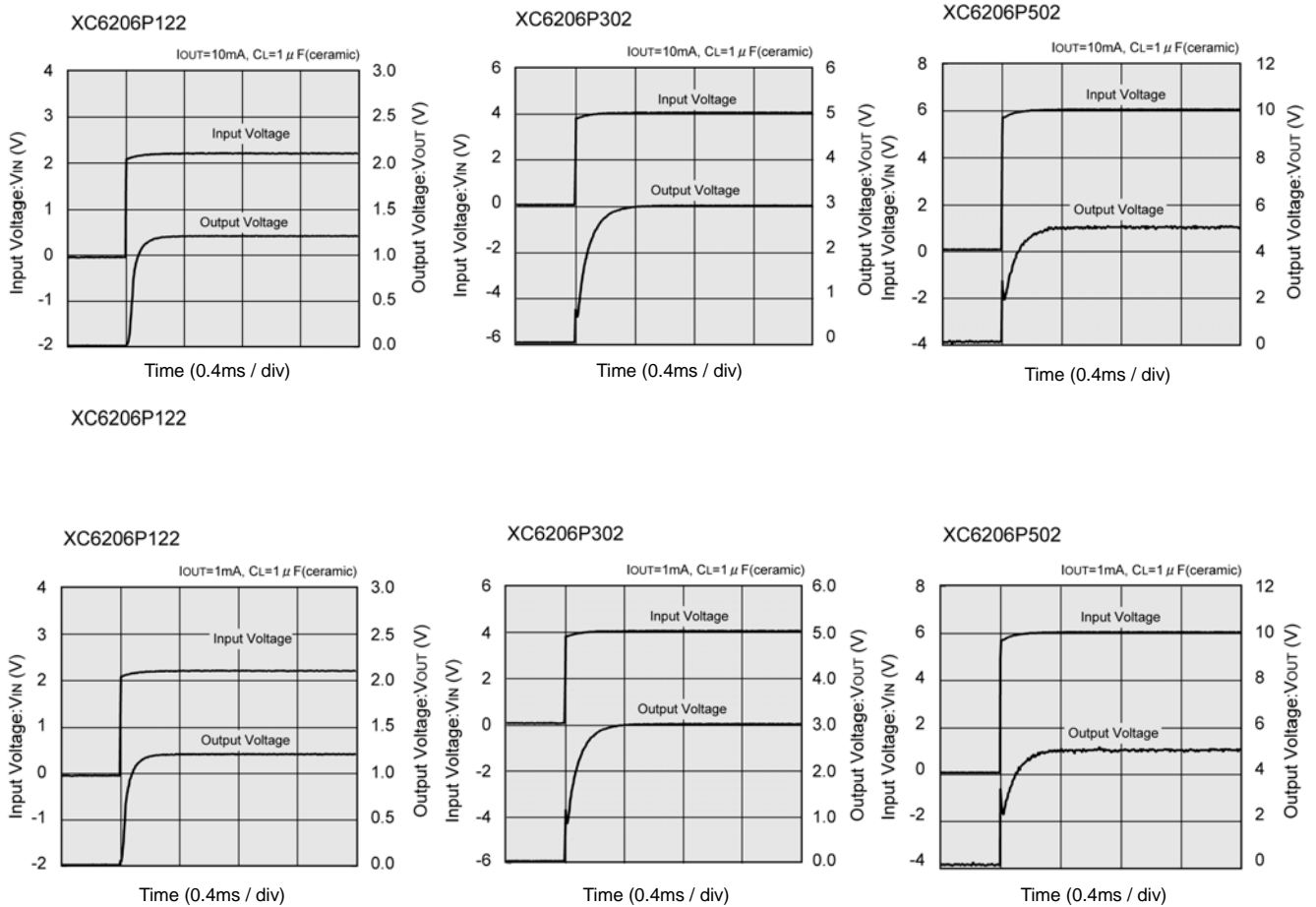

TYPICAL PERFORMANCE CHARACTERISTICS (Continued)

(9) Input Transient Response 2

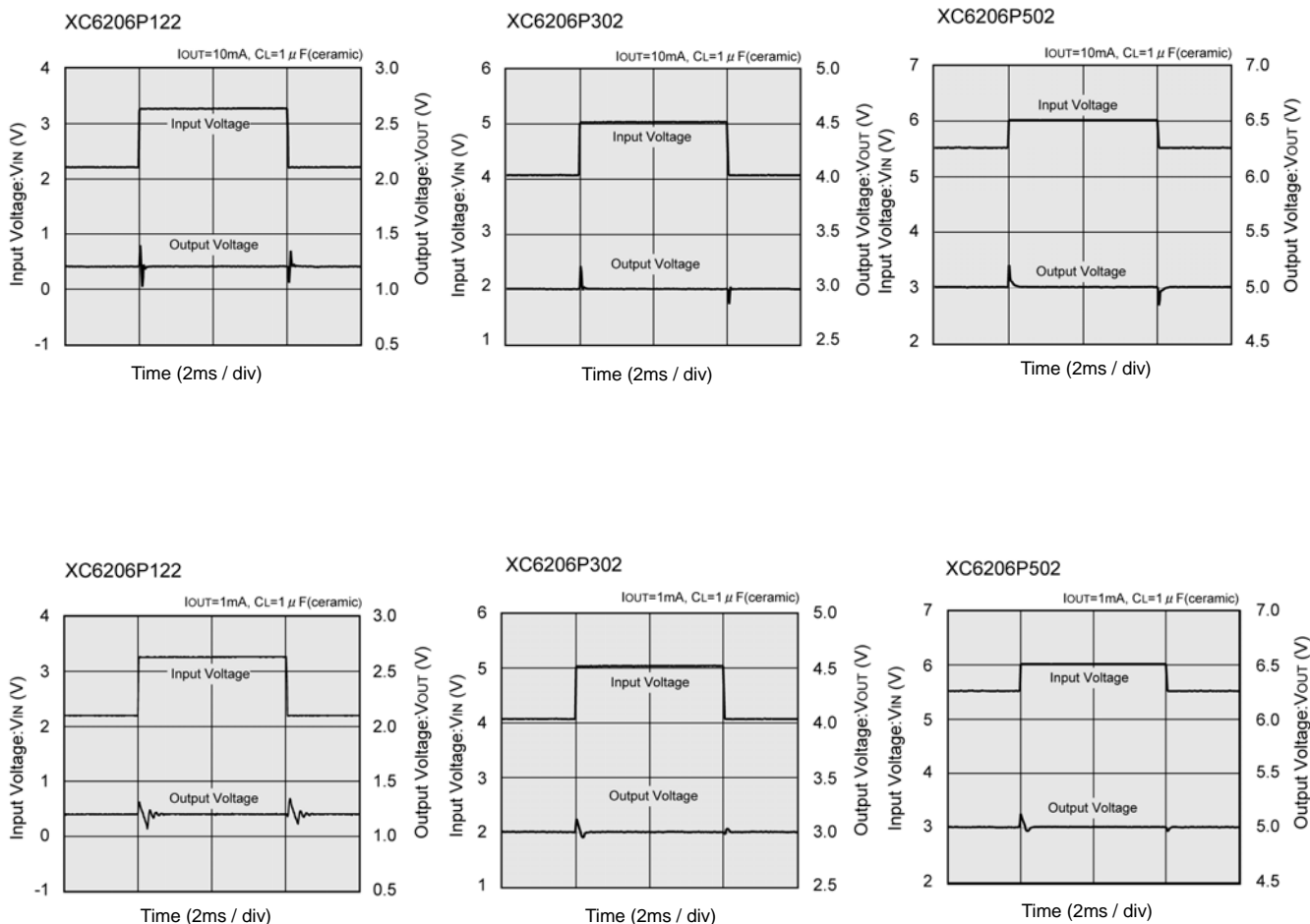

(10) Load Transient Response

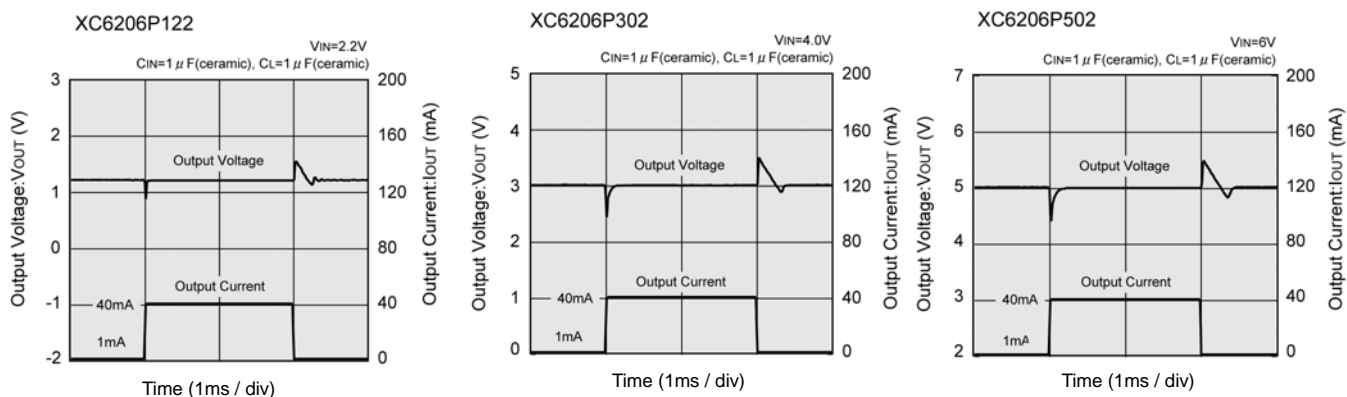

TYPICAL PERFORMANCE CHARACTERISTICS (Continued)

(11) Ripple Rejection Rate

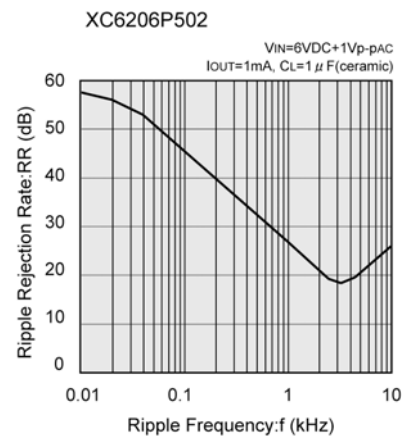
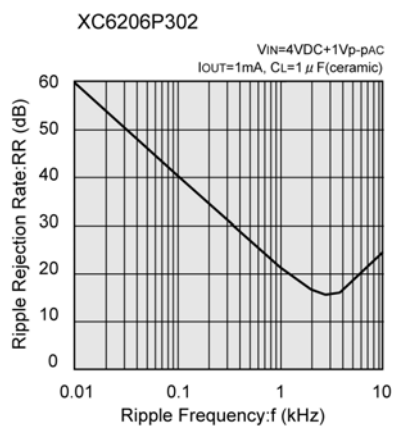
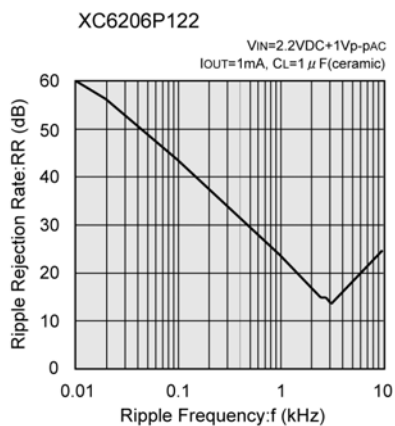
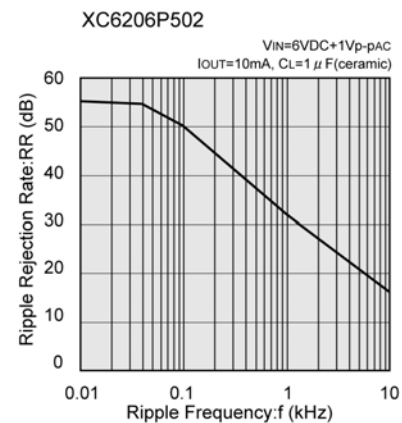
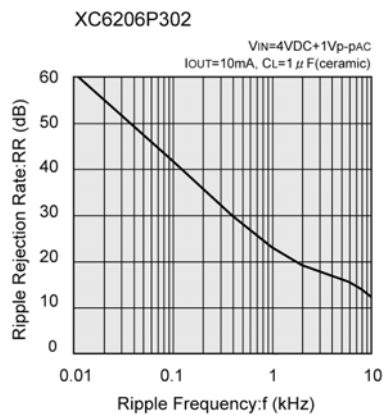
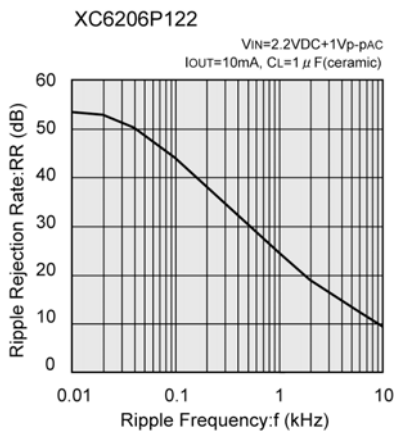

PACKAGING INFORMATION

SOT-23

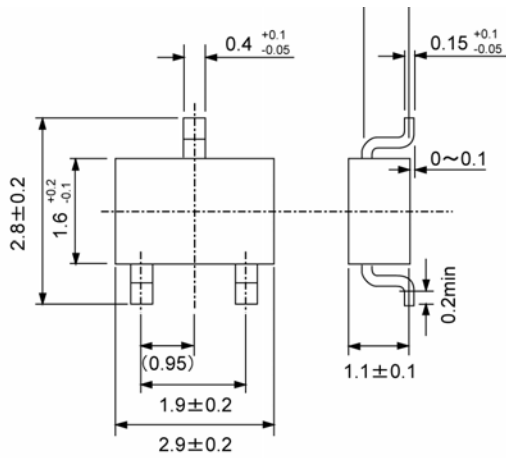

SOT-89

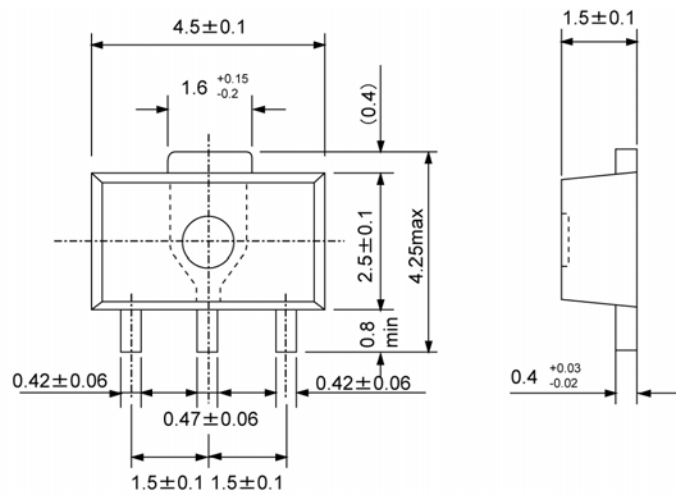

USP-6B

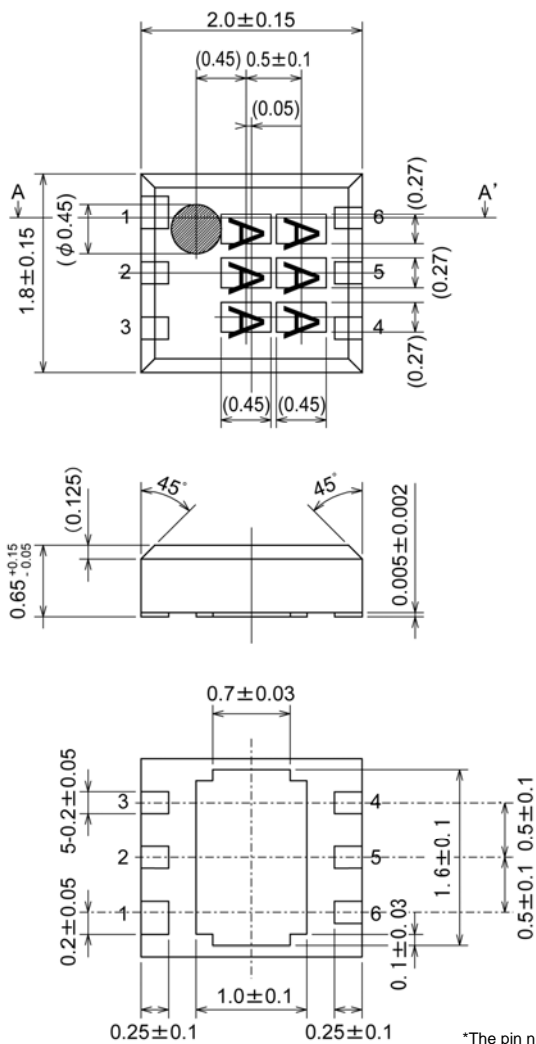

TO-92

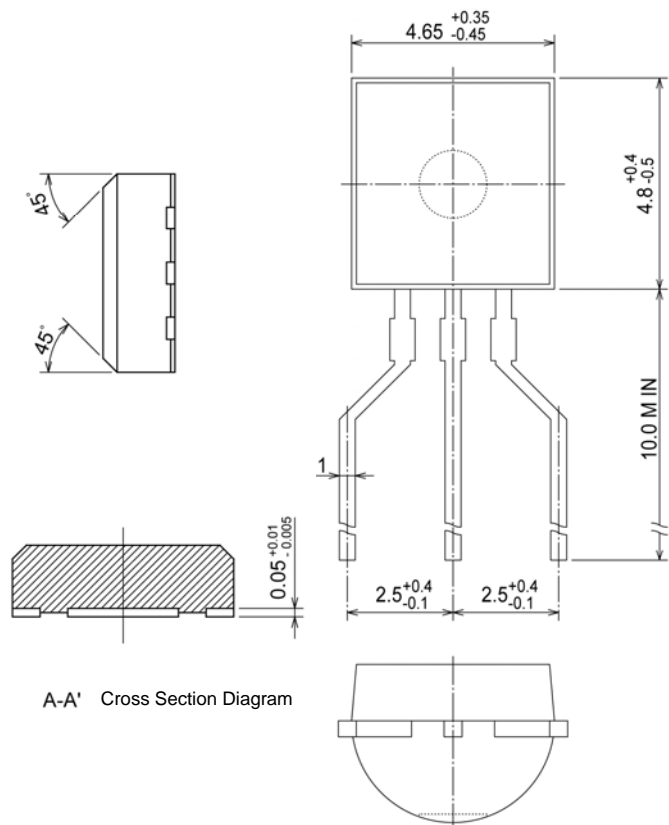

*The pin number 1 is larger than the other pins

PACKAGING INFORMATION (Continued)

USP-6B Reference Pattern Layout

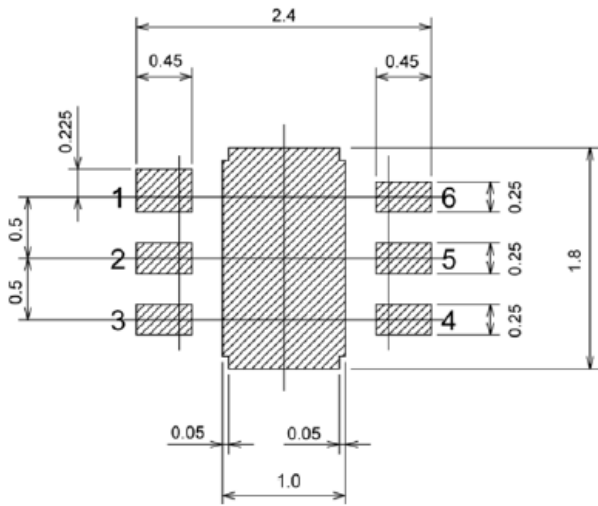

USP-6B Reference Metal Mask Design

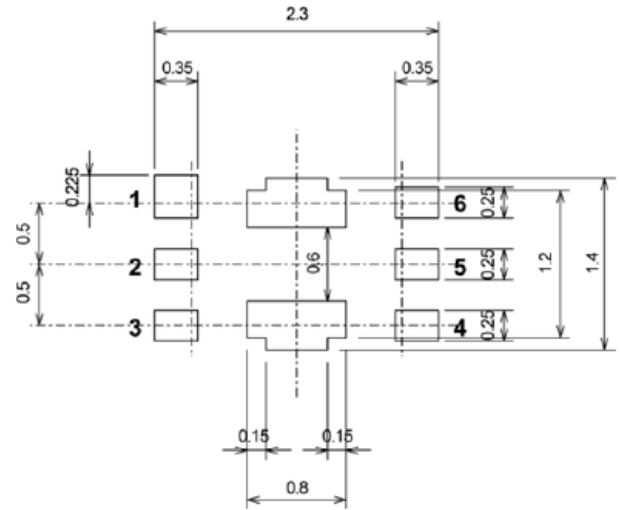

MARKING RULE

SOT-23, SOT-89

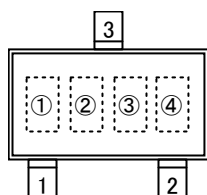

SOT-23
(TOP VIEW)

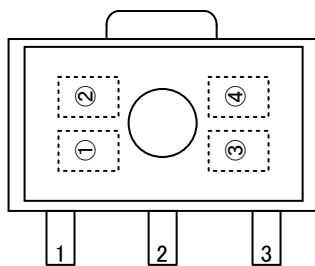

SOT-89
(TOP VIEW)

Represents product number

MARK	PRODUCT SERIES
6	XC6206P*****

Represents 3 pins regulator

MARK		PRODUCT SERIES
VOLTAGE = 0.1 ~ 3.0V	VOLTAGE = 3.1 ~ 6.0V	
5	6	XC6206P*****

Represents output voltage

MARK	VOLTAGE (V)			MARK	OUTPUT VOLTAGE (V)		
0	-	3.1	-	F	1.6	4.6	-
1	-	3.2	-	H	1.7	4.7	-
2	-	3.3	-	K	1.8	4.8	-
3	-	3.4	-	L	1.9	4.9	-
4	-	3.5	-	M	2.0	5.0	-
5	-	3.6	-	N	2.1	-	-
6	-	3.7	-	P	2.2	-	-
7	-	3.8	-	R	2.3	-	-
8	-	3.9	-	S	2.4	-	-
9	-	4.0	-	T	2.5	-	-
A		4.1	-	U	2.6	-	-
B	1.2	4.2	-	V	2.7	-	-
C	1.3	4.3	-	X	2.8	-	-
D	1.4	4.4	-	Y	2.9	-	-
E	1.5	4.5	-	Z	3.0	-	-

Represents production lot number

0 to 9, A to Z repeated. (G, I, J, O, Q, W excepted)

*No character inversion used.

MARKING RULE (Continued)

USP-6B

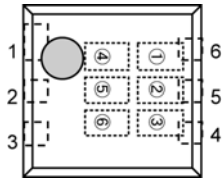

USP-6B
(TOP VIEW)

Represents product number

MARK		PRODUCT SERIES
0	6	XC6206P***D*

Represents 3 pins regulator

MARK		PRODUCT SERIES
P		XC6206P***D*

Represents output voltage

MARK		OUTPUT VOLTAGE(V)	PRODUCT SERIES
3	3	3.3	XC6206P33*D*
5	0	5.0	XC6206P50*D*

Represents production lot number

0 to 9, A to Z repeated. (G, I, J, O, Q, W excepted)

*No character inversion used.

TO-92

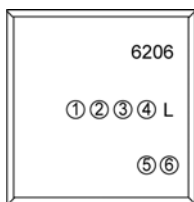

TO-92 (L Type)
(TOP VIEW)

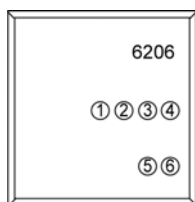

TO-92 (T Type)
(TOP VIEW)

Represents type of regulator

MARK		PRODUCT SERIES
P		XC6206P*****

Represents output voltage

MARK		VOLTAGE (V)	PRODUCT SERIES
3	3	3.3	XC6206P33***
5	0	5	XC6206P50***

Represents detect voltage accuracy

MARK	DETECT VOLTAGE ACCURACY	PRODUCT SERIES
1	Within $\pm 1\%$	XC6206P**1**
2	Within $\pm 2\%$	XC6206P**2**

Represents least significant digit of the production year

MARK		PRODUCTION YEAR
3		2003
4		2004

Represents production lot number

0 to 9, A to Z repeated. (G, I, J, O, Q, W excepted)

*No character inversion used.

1. The products and product specifications contained herein are subject to change without notice to improve performance characteristics. Consult us, or our representatives before use, to confirm that the information in this datasheet is up to date.
2. We assume no responsibility for any infringement of patents, patent rights, or other rights arising from the use of any information and circuitry in this datasheet.
3. Please ensure suitable shipping controls (including fail-safe designs and aging protection) are in force for equipment employing products listed in this datasheet.
4. The products in this datasheet are not developed, designed, or approved for use with such equipment whose failure or malfunction can be reasonably expected to directly endanger the life of, or cause significant injury to, the user.
(e.g. Atomic energy; aerospace; transport; combustion and associated safety equipment thereof.)
5. Please use the products listed in this datasheet within the specified ranges.
Should you wish to use the products under conditions exceeding the specifications, please consult us or our representatives.
6. We assume no responsibility for damage or loss due to abnormal use.
7. All rights reserved. No part of this datasheet may be copied or reproduced without the prior permission of TOREX SEMICONDUCTOR LTD.

TOREX SEMICONDUCTOR LTD.