

■ BLOCK DIAGRAM

*Fixed Output Voltage Type

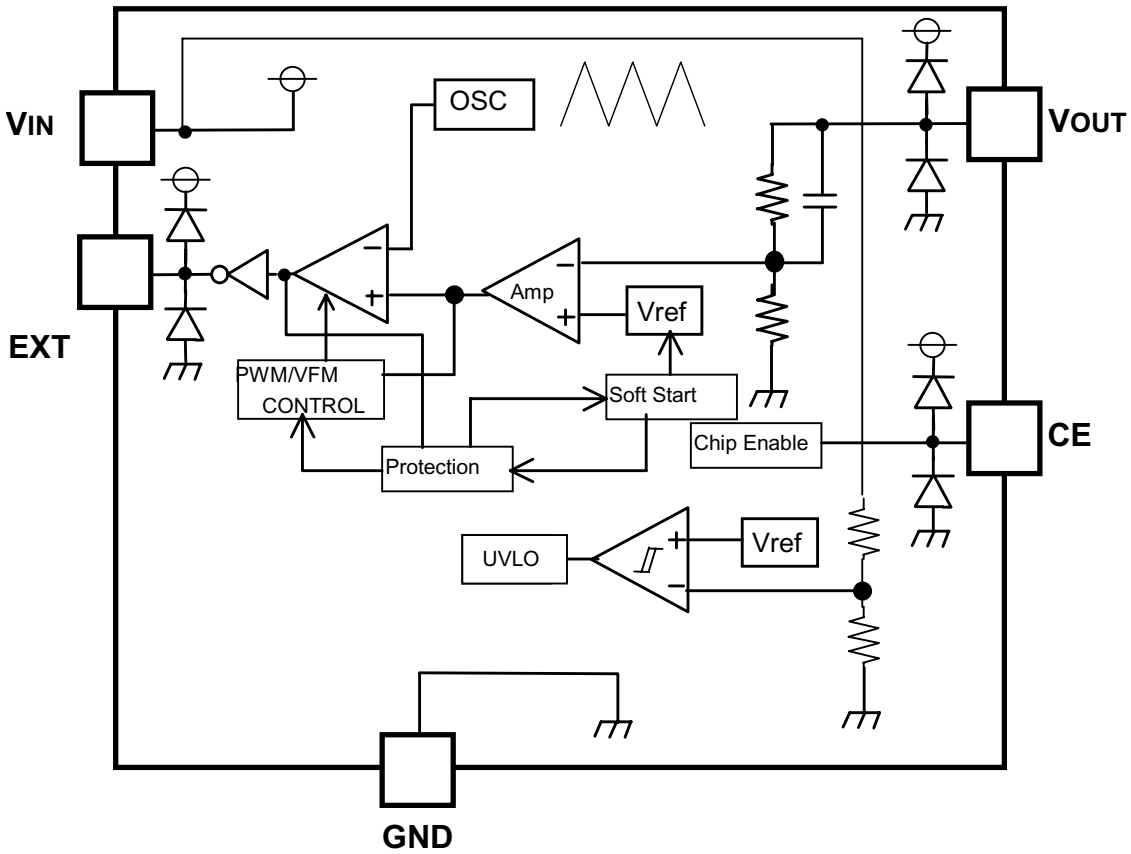

*Adjustable Output Voltage Type

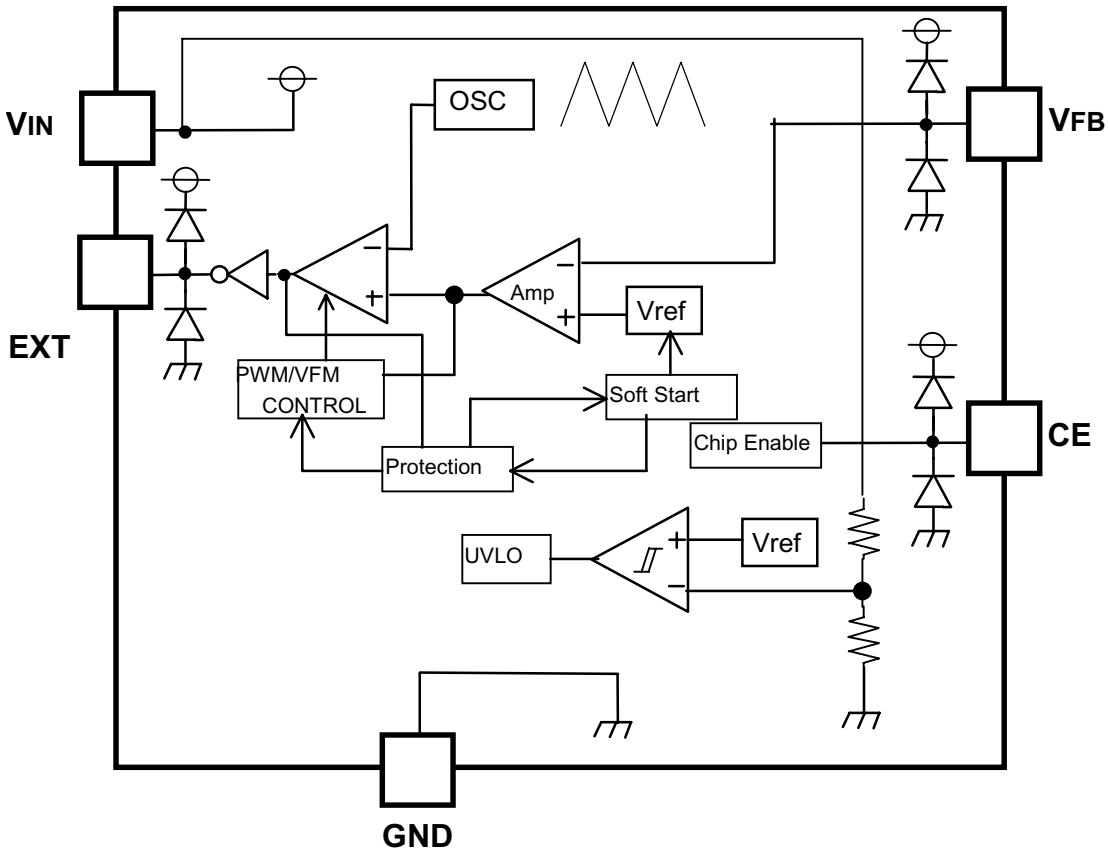

SELECTION GUIDE

In the R1224N Series, the output voltage, the oscillator frequency, the optional function, and the taping type for the ICs can be selected at the user's request.

The selection can be made with designating the part number as shown below;

R1224NXX2X-TR

↑ ↑ ↑
a b c

Code	Contents
a	Setting Output Voltage(V_{OUT}): Stepwise setting with a step of 0.1V in the range of 1.2V to 6.0V is possible. Adjustable type; a=10 means Reference voltage=1.0V Optional Function is G/H/M.
b	Designation of Oscillator Frequency 2 : fixed
c	Designation of Optional Function E : 300kHz, with a PWM/VFM alternative circuit F : 500kHz, with a PWM/VFM alternative circuit G : 300kHz, without a PWM/VFM alternative circuit H : 500kHz, without a PWM/VFM alternative circuit L : 180kHz, with a PWM/VFM alternative circuit M : 180kHz, without a PWM/VFM alternative circuit

PIN CONFIGURATION

● SOT-23-5

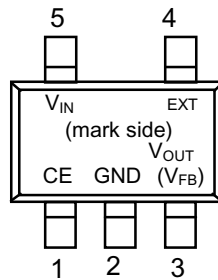

PIN DESCRIPTION

Pin No.	Symbol	Description
1	CE	Chip Enable Pin (Active with "H")
2	GND	Ground Pin
3	$V_{OUT}/(V_{FB})$	Pin for Monitoring Output Voltage(Feedback Voltage)
4	EXT	External Transistor Drive Pin(CMOS Output)
5	V_{IN}	Power Supply Pin

■ ABSOLUTE MAXIMUM RATINGS

(GND=0V)

Symbol	Item	Rating	Unit
V _{IN}	V _{IN} Supply Voltage	20	V
V _{EXT}	EXT Pin Output Voltage	-0.3~V _{IN} +0.3	V
V _{CE}	CE Pin Input Voltage	-0.3~V _{IN} +0.3	V
V _{OUT} /(V _{FB})	V _{OUT} /V _{FB} Pin Input Voltage	-0.3~V _{IN} +0.3	V
I _{EXT}	EXT Pin Inductor Drive Output Current	±50	mA
PD	Power Dissipation	250	mW
T _{opt}	Operating Temperature Range	-40~+85	°C
T _{stg}	Storage Temperature Range	-55~+125	°C

■ ELECTRICAL CHARACTERISTICS

●R1224Nxx2X (X=E/F/G/H/L/M) except R1224N102X

(T_{opt}=25°C)

Symbol	Item	Conditions	Min.	Typ.	Max.	Unit
V _{IN}	Operating Input Voltage		2.3		18.5	V
V _{OUT}	Step-down Output Voltage	V _{IN} =V _{CE} =V _{SET} +1.5V, I _{OUT} =-100mA When V _{SET} ≤1.5V, V _{IN} =V _{CE} =3.0V	V _{SET} × 0.98	V _{SET}	V _{SET} × 1.02	V
ΔV _{OUT} / ΔT	Step-down Output Voltage Temperature Coefficient	-40°C ≤ T _{opt} ≤ 85°C		±100		ppm /°C
f _{osc}	Oscillator Frequency	V _{IN} =V _{CE} =V _{SET} +1.5V, I _{OUT} =-100mA When V _{SET} ≤1.5, V _{IN} =V _{CE} =3.0V L/M version E/G version F/H version	144 240 400	180 300 500	216 360 600	kHz
Δf _{osc} / ΔT	Oscillator Frequency Temperature Coefficient	-40°C ≤ T _{opt} ≤ 85°C		±0.2		% /°C
I _{DD1}	Supply Current1	V _{IN} =V _{CE} =V _{OUT} =18.5V E/F/L/M version G version H version		20 30 40	50 60 80	μA
I _{stb}	Standby Current	V _{IN} =18.5V, V _{CE} =0V, V _{OUT} =0V		0.0	0.5	μA
I _{EXTH}	EXT "H" Output Current	V _{IN} =8V, V _{EXT} =7.9V, V _{OUT} =8V, V _{CE} =8V		-17	-10	mA
I _{EXTL}	EXT "L" Output Current	V _{IN} =8V, V _{EXT} =0.1V, V _{OUT} =0V, V _{CE} =8V	20	30		mA
I _{CEH}	CE "H" Input Current	V _{IN} =V _{CE} =V _{OUT} =18.5V		0.0	0.5	μA
I _{CEL}	CE "L" Input Current	V _{IN} =V _{OUT} =18.5V, V _{CE} =0V	-0.5	0.0		μA
V _{CEH}	CE "H" Input Voltage	V _{IN} =8V, V _{OUT} =0V	1.5			V
V _{CEL}	CE "L" Input Voltage	V _{IN} =8V, V _{OUT} =0V			0.3	V
Maxdty	Oscillator Maximum Duty Cycle		100			%
VFMdty	VFM Duty Cycle	E/F/L version		35		%
V _{UVLO1}	UVLO Voltage	V _{IN} =V _{CE} =2.5V to 1.5V, V _{OUT} =0V	1.8	2.0	2.2	V
V _{UVLO2}	UVLO Release Voltage	V _{IN} =V _{CE} =1.5V to 2.5V, V _{OUT} =0V		V _{UVLO1} +0.1	2.3	V
T _{start}	Delay Time by Soft-Start function	V _{IN} =V _{SET} +1.5V, I _{OUT} =-10mA V _{CE} =0V->V _{SET} +1.5V	5	10	20	ms
T _{prot}	Delay Time for protection circuit	V _{IN} =V _{CE} =V _{SET} +1.5V V _{OUT} =V _{SET} +1.5V->0V	5	15	30	ms

●R1224N102X (X=G/H/M)

(Topt=25°C)

Symbol	Item	Conditions	Min.	Typ.	Max.	Unit
V _{IN}	Operating Input Voltage		2.3		18.5	V
V _{FB}	Feedback Voltage	V _{IN} =V _{CE} =3.5V, I _{FB} =-100mA	0.98	1.00	1.02	V
ΔV _{FB} /ΔT	Feedback Voltage Temperature Coefficient	-40°C ≤ Topt ≤ 85°C		±100		ppm/°C
fosc	Oscillator Frequency	V _{IN} =V _{CE} =3.5V, I _{FB} =-100mA M version G version H version	144 240 400	180 300 500	216 360 600	kHz
Δfosc/ΔT	Oscillator Frequency Temperature Coefficient	-40°C ≤ Topt ≤ 85°C		±0.2		%/°C
I _{DD1}	Supply Current1	V _{IN} =V _{CE} =V _{FB} =18.5V M version G version H version		20 30 40	50 60 80	μA
I _{stb}	Standby Current	V _{IN} =18.5V, V _{CE} =0V, V _{FB} =0V		0.0	0.5	μA
I _{EXTH}	EXT "H" Output Current	V _{IN} =8V, V _{EXT} =7.9V, V _{FB} =8V, V _{CE} =8V		-17		mA
I _{EXTL}	EXT "L" Output Current	V _{IN} =8V, V _{EXT} =0.1V, V _{FB} =0V, V _{CE} =8V		30		mA
I _{CEH}	CE "H" Input Current	V _{IN} =V _{CE} =V _{FB} =18.5V		0.0	0.5	μA
I _{CEL}	CE "L" Input Current	V _{IN} =V _{FB} =18.5V, V _{CE} =0V	-0.5	0.0		μA
V _{CEH}	CE "H" Input Voltage	V _{IN} =8V, V _{FB} =0V	1.5			V
V _{CEL}	CE "L" Input Voltage	V _{IN} =8V, V _{FB} =0V			0.3	V
Maxdty	Oscillator Maximum Duty Cycle		100			%
V _{UVLO1}	UVLO Voltage	V _{IN} =V _{CE} =2.5V to 1.5V, V _{FB} =0V	1.8	2.0	2.2	V
V _{UVLO2}	UVLO Release Voltage	V _{IN} =V _{CE} =1.5V to 2.5V, V _{FB} =0V		V _{UVLO1} +0.1	2.3	V
T _{start}	Delay Time by Soft-Start function	V _{IN} =2.5V, I _{FB} =-10mA V _{CE} =0V->2.5V	5	10	20	ms
T _{prot}	Delay Time for protection circuit	V _{IN} =V _{CE} =2.5V V _{FB} =2.5V->0V	5	15	30	ms

■ TYPICAL APPLICATION AND APPLICATION HINTS

(1) Fixed Output Voltage Type (R1224Nxx2E/F/G/H/L/M except xx=10)

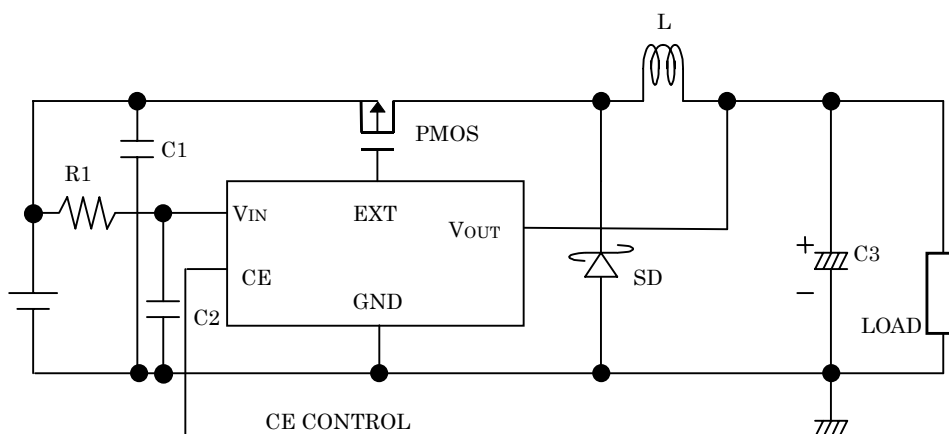

PMOS: HAT1044M (Hitachi) L: CR105-270MC (Sumida, 27μH)
SD1: RB063L-30 (Rohm) C3: 47μF (Tantalum Type)
C1: 10μF (Ceramic Type) C2: 0.1μF (Ceramic Type)
R1: 10Ω

(2) Adjustable Output Type (R1224N102G/H/M) Example: Output Voltage=3.2V

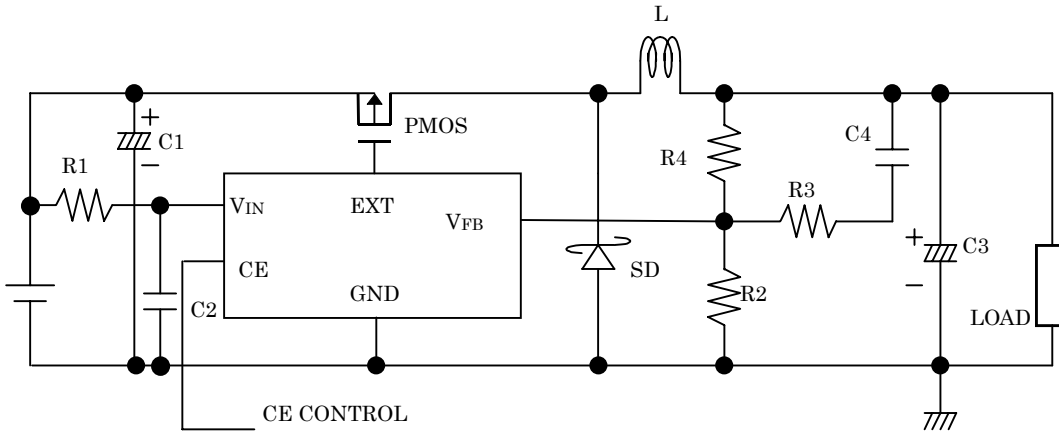

PMOS: HAT1044M (Hitachi) L: CR105-270MC (Sumida, 27 μ H)

SD1: RB063L-30 (Rohm) C3: 47 μ F (Tantalum Type)

C1: 10 μ F (Ceramic Type) C2: 0.1 μ F (Ceramic Type) C4: 1000pF (Ceramic Type)

R1: 10 Ω , R2=22k Ω , R3=2.7k Ω , R4=33k Ω

When you use these ICs, consider the following issues;

- As shown in the block diagram, a parasitic diode is formed in each terminal, each of these diodes is not formed for load current, therefore do not use it in such a way. When you control the CE pin by another power supply, do not make its "H" level more than the voltage level of VIN pin.
- Set external components as close as possible to the IC and minimize the connection between the components and the IC. In particular, a capacitor should be connected to VOUT pin with the minimum connection. Make sufficient ground and reinforce supplying. A large switching current could flow through the connection of power supply, an inductor and the connection of VOUT. If the impedance of the connection of power supply is high, the voltage level of power supply of the IC fluctuates with the switching current. This may cause unstable operation of the IC.
- Protection circuit may work if the maximum duty cycle continue for the time defined in the electrical characteristics. Once after stopping the output voltage, output will restart with soft-start operation. If the difference between input voltage and output voltage is small, the protection circuit may work.
- Use capacitors with a capacity of 22 μ F or more for VOUT pin, and with good high frequency characteristics such as tantalum capacitors. We recommend you to use output capacitors with an allowable voltage at least twice as much as setting output voltage. This is because there may be a case where a spike-shaped high voltage is generated by an inductor when an external transistor is on and off.
- Choose an inductor that has sufficiently small D.C. resistance and large allowable current and is hard to reach magnetic saturation. And if the value of inductance of an inductor is extremely small, the ILX may exceed the absolute maximum rating at the maximum loading.
Use an inductor with appropriate inductance.
- Use a diode of a Schottky type with high switching speed, and also pay attention to its current capacity.
- Do not use this IC under the condition with VIN voltage at equal or less than minimum operating voltage.
- When the threshold level of an external power MOSFET is rather low and the drive-ability of voltage supplier is small, if the output pin is short circuit, input voltage may be equal or less than UVLO detector threshold. In this case, the device is reset with UVLO function that is different from the reset-protection function caused by maximum duty cycle.
- With the PWM/VFM alternative circuit, when the on duty cycle of switching is 35% or less, the R1225N alters from PWM mode to VFM mode (Pulse skip mode). The purpose of this circuit is raising the efficiency with a light load by skipping the frequency and suppressing the consumption current. However, the ratio of output voltage against input

voltage is 35% or less, (ex. $V_{in} > 8.6V$ and $V_{out} = 3.0V$) even if the large current may be loaded, the IC keeps its VFM mode. As a result, frequency might be decreased, and oscillation waveform might be unstable. These phenomena are the typical characteristics of the IC with PWM/VFM alternative circuit.

☆ The performance of power source circuits using these ICs extremely depends upon the peripheral circuits. Pay attention in the selection of the peripheral circuits. In particular, design the peripheral circuits in a way that the values such as voltage, current, and power of each component, PCB patterns and the IC do not exceed their respected rated values.

■ How to Adjust Output Voltage and about Phase Compensation

As for Adjustable Output type, feedback pin (VFB) voltage is controlled to maintain 1.0V. Output Voltage, V_{OUT} is as following equation:

$$V_{OUT} : R2 + R4 = V_{FB} : R2$$

$$V_{OUT} = V_{FB} \times (R2 + R4) / R2$$

Thus, with changing the value of $R2$ and $R4$, output voltage can be set in the specified range. In the DC/DC converter, with the load current and external components such as L and C , phase might be behind 180 degree. In this case, the phase margin of the system will be less and stability will be worse. To prevent this, phase margin should be secured with proceeding the phase. A pole is formed with external components L and $C3$.

$$F_{pole} \sim 1 / 2\pi \sqrt{L \times C3}$$

A zero (signal back to zero) is formed with $R4$ and $C4$.

$$\cong F_{zero} \sim 1 / (2\pi \times R4 \times C4)$$

For example, if $L = 27\mu H$, $C3 = 47\mu F$, the cut off frequency of the pole is approximately 4.5kHz. To make the cut off frequency of the pole as much as 4.5kHz, set $R4 = 33k\Omega$ and $C4 = 1000pF$. If V_{OUT} is set at 2.5V, $R2 = 22k\Omega$ is appropriate. $R3$ prevents feedback of the noise to VFB pin, about 2.7k Ω is appropriate value.

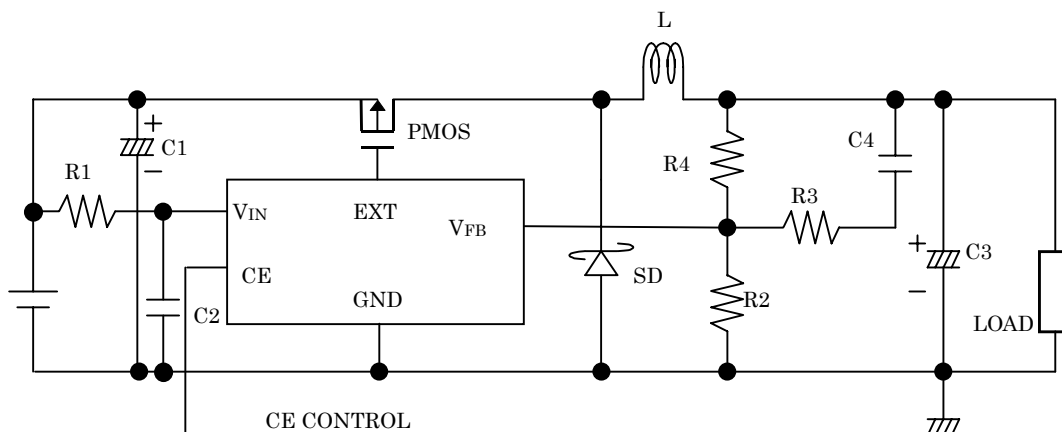

■ OPERATION of step-down DC/DC converter and Output Current

The step-down DC/DC converter charges energy in the inductor when Lx transistor is ON, and discharges the energy from the inductor when Lx transistor is OFF and controls with less energy loss, so that a lower output voltage than the input voltage is obtained. The operation will be explained with reference to the following diagrams:

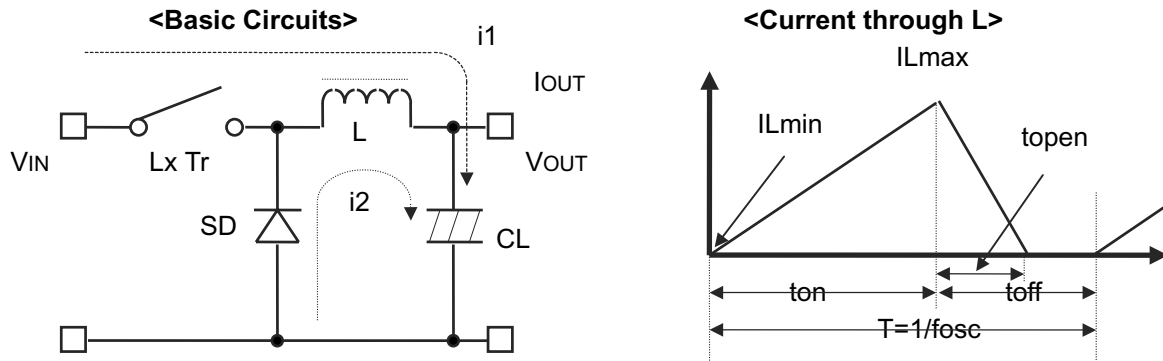

Step 1: Lx Tr. turns on and current I_L ($=i1$) flows, and energy is charged into CL. At this moment, I_L increases from I_{Lmin} . ($=0$) to reach I_{Lmax} . in proportion to the on-time period(t_{on}) of LX Tr.

Step 2: When Lx Tr. turns off, Schottky diode (SD) turns on in order that L maintains I_L at I_{Lmax} , and current I_L ($=i2$) flows.

Step 3: I_L decreases gradually and reaches I_{Lmin} . after a time period of t_{open} , and SD turns off, provided that in the continuous mode, next cycle starts before I_L becomes to 0 because t_{off} time is not enough. In this case, I_L value is from this I_{Lmin} (>0).

In the case of PWM control system, the output voltage is maintained by controlling the on-time period (t_{on}), with the oscillator frequency (f_{osc}) being maintained constant.

● Discontinuous Conduction Mode and Continuous Conduction Mode

The maximum value (I_{Lmax}) and the minimum value (I_{Lmin}) current which flow through the inductor is the same as those when Lx Tr. is ON and when it is OFF.

The difference between I_{Lmax} and I_{Lmin} , which is represented by ΔI ;

$$\Delta I = I_{Lmax} - I_{Lmin} = V_{OUT} \times t_{open} / L = (V_{IN} - V_{OUT}) \times t_{on} / L \dots \text{Equation 1}$$

wherein, $T = 1/f_{osc} = t_{on} + t_{off}$

$$\text{duty (\%)} = t_{on} / T \times 100 = t_{on} \times f_{osc} \times 100$$

$$t_{open} \leq t_{off}$$

In Equation 1, $V_{OUT} \times t_{open} / L$ and $(V_{IN} - V_{OUT}) \times t_{on} / L$ are respectively shown the change of the current at ON, and the change of the current at OFF.

When the output current (I_{OUT}) is relatively small, $t_{open} < t_{off}$ as illustrated in the above diagram. In this case, the energy is charged in the inductor during the time period of t_{on} and is discharged in its entirely during the time period of t_{off} , therefore I_{Lmin} becomes to zero ($I_{Lmin} = 0$). When I_{OUT} is gradually increased, eventually, t_{open} becomes to t_{off} ($t_{open} = t_{off}$), and when I_{OUT} is further increased, I_{Lmin} becomes larger than zero ($I_{Lmin} > 0$). The former mode is referred to as the discontinuous mode and the latter mode is referred to as continuous mode.

In the continuous mode, when Equation 1 is solved for t_{on} and assumed that the solution is t_{onc} ,

$$t_{onc} = T \times V_{OUT} / V_{IN} \dots \text{Equation 2}$$

When $t_{on} < t_{onc}$, the mode is the discontinuous mode, and when $t_{on} = t_{onc}$, the mode is the continuous mode.

■ OUTPUT CURRENT AND SELECTION OF EXTERNAL COMPONENTS

When Lx Tr. is ON:

(Wherein, Ripple Current P-P value is described as I_{RP} , ON resistance of LX Tr. is described as R_p the direct current of the inductor is described as R_L .)

$$V_{IN} = V_{OUT} + (R_p + R_L) \times I_{OUT} + L \times I_{RP} / t_{on} \dots \text{Equation 3}$$

When Lx Tr. is OFF:

$$L \times I_{RP} / t_{off} = V_F + V_{OUT} + R_L \times I_{OUT} \dots \text{Equation 4}$$

Put Equation 4 to Equation 3 and solve for ON duty, $t_{on} / (t_{off} + t_{on}) = D_{ON}$,

$$D_{ON} = (V_{OUT} + V_F + R_L \times I_{OUT}) / (V_{IN} + V_F - R_p \times I_{OUT}) \dots \text{Equation 5}$$

Ripple Current is as follows;

$$I_{RP} = (V_{IN} - V_{OUT} - R_p \times I_{OUT} - R_L \times I_{OUT}) \times D_{ON} / f / L \dots \text{Equation 6}$$

Wherein, peak current that flows through L, Lx Tr., and SD is as follows;

$$I_{Lmax} = I_{OUT} + I_{RP} / 2 \dots \text{Equation 7}$$

Consider I_{Lmax} , condition of input and output and select external components.

★The above explanation is directed to the calculation in an ideal case in continuous mode.

■ External Components

1. Inductor

Select an inductor that peak current does not exceed I_{Lmax} . If larger current than allowable current flows, magnetic saturation occurs and make transform efficiency worse.

When the load current is definite, the smaller value of L, the larger the ripple current.

Provided that the allowable current is large in that case and DC current is small, therefore, for large output current, efficiency is better than using an inductor with a large value of L and vice versa.

2. Diode

Use a diode with low V_F (Schottky type is recommended.) and high switching speed.

Reverse voltage rating should be more than V_{IN} and current rating should be equal or more than I_{Lmax} .

3. Capacitors

As for C_{IN} , use a capacitor with low ESR (Equivalent Series Resistance) and a capacity of at least $10\mu F$ for stable operation.

C_{OUT} can reduce ripple of Output Voltage, therefore $47\mu F$ or more value of tantalum type capacitor is recommended.

4. Lx Transistor

Pch Power MOSFET is required for this IC.

Its breakdown voltage between gate and source should be a few V higher than Input Voltage.

In the case of Input Voltage is low, to turn on MOSFET completely, to use a MOSFET with low threshold voltage is effective.

If a large load current is necessary for your application and important, choose a MOSFET with low ON resistance for good efficiency.

If a small load current is mainly necessary for your application, choose a MOSFET with low gate capacity for good efficiency.

Maximum continuous drain current of MOSFET should be larger than peak current, I_{Lmax} .

■ TEST CIRCUITS

A) Output Voltage, Oscillator Frequency, CE“H” Input Voltage, CE“L” Input Voltage, Soft-start time

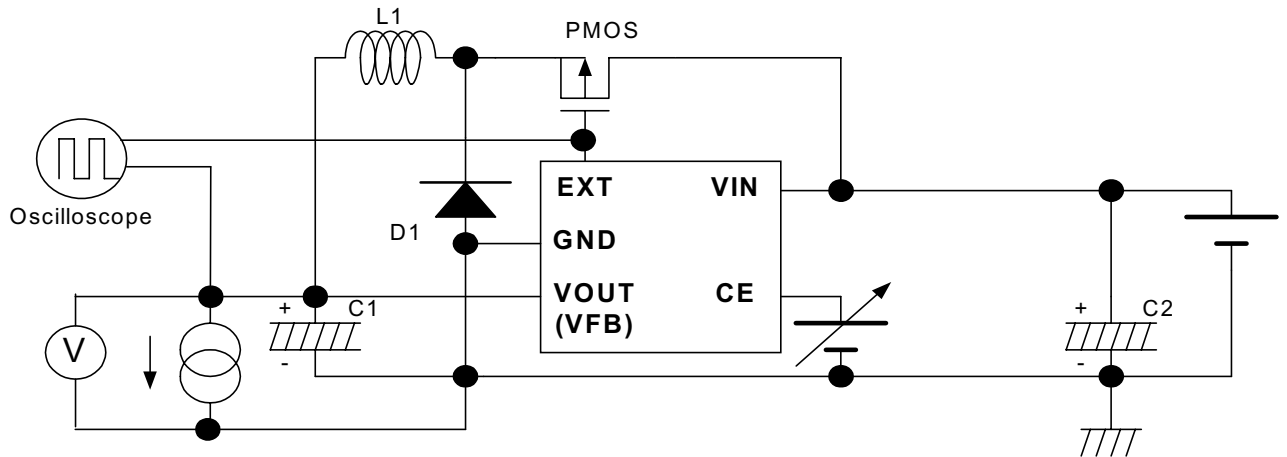

B) Supply Current1

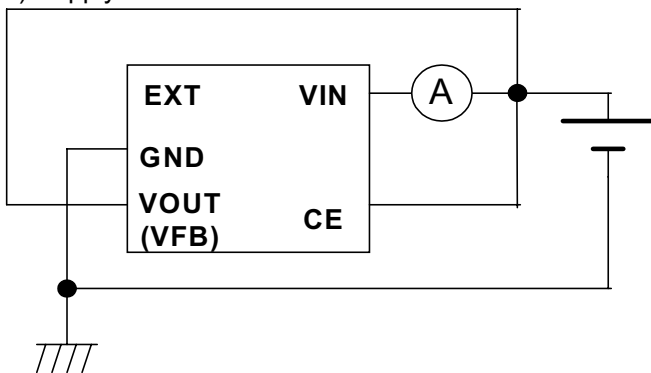

C) Standby Current

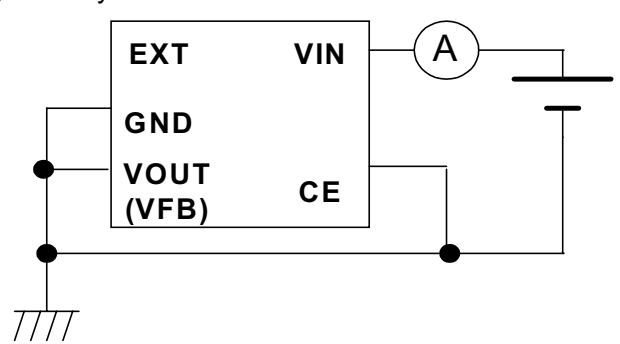

D) EXT “H” Output Current

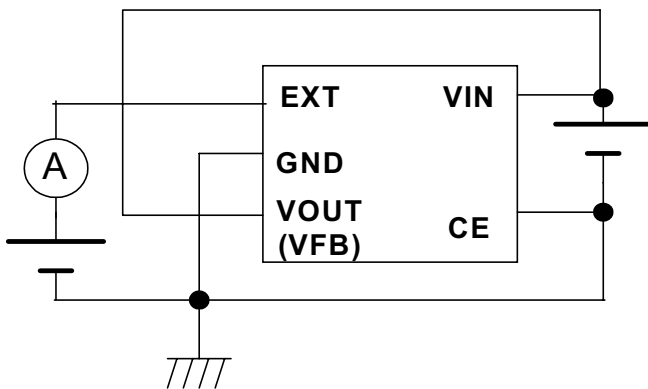

E) EXT “L” Output Current

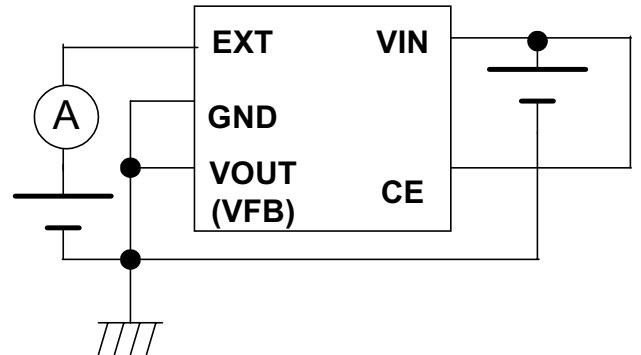

F) CE “H” Input Current, CE “L” Input Current

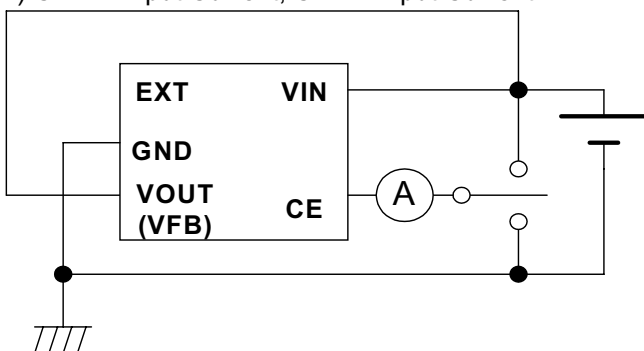

G) Output Delay Time for Protection Circuit

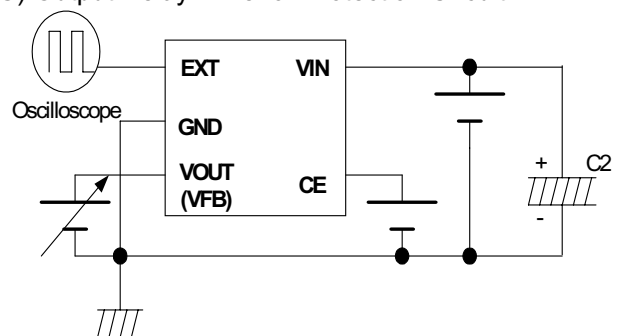

PMOS: HAT1044M (Hitachi) L: CD104-270MC (Sumida, 27 μ H)

SD1: RB491D (Rohm)

C1: 47 μ F (Tantalum Type) C2: 47 μ F (Tantalum Type)

■ TYPICAL CHARACTERISTICS

1) Output Voltage vs. Output Current (*Note)

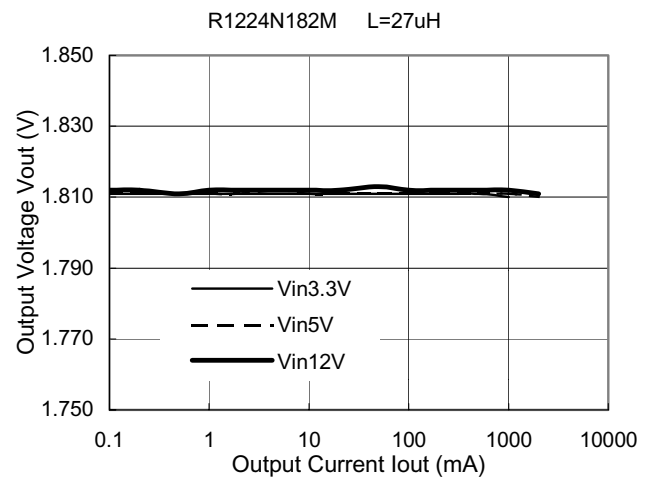
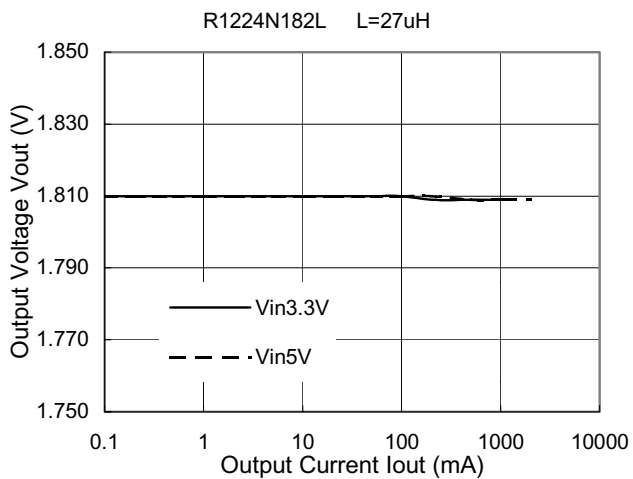
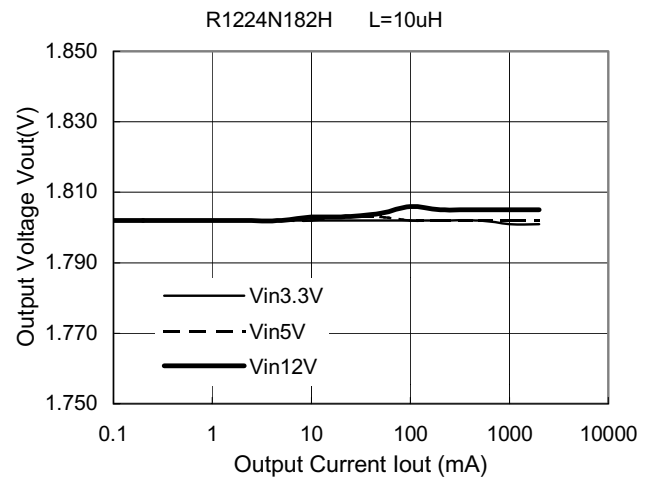
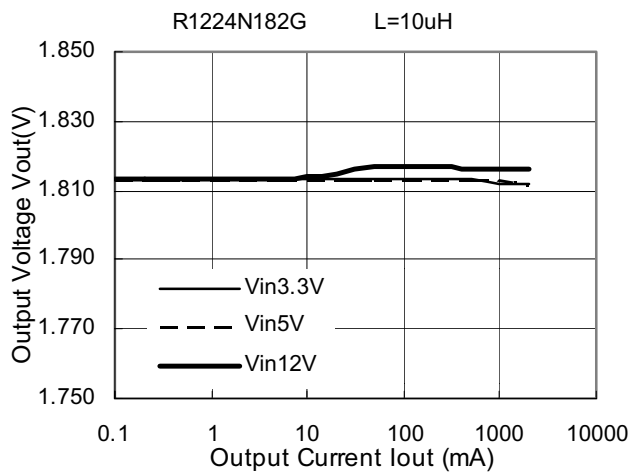
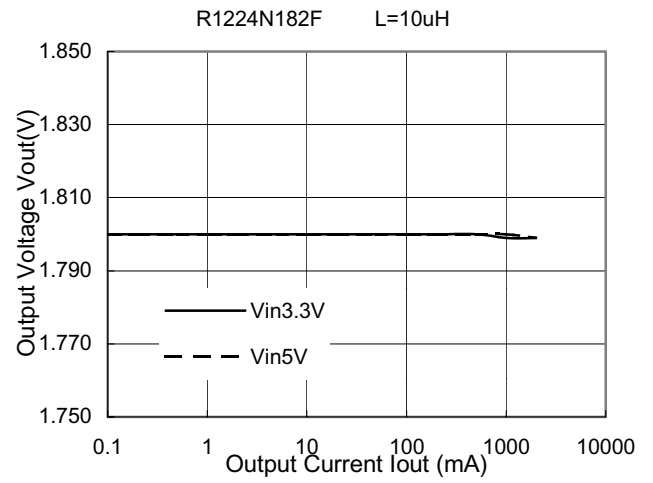
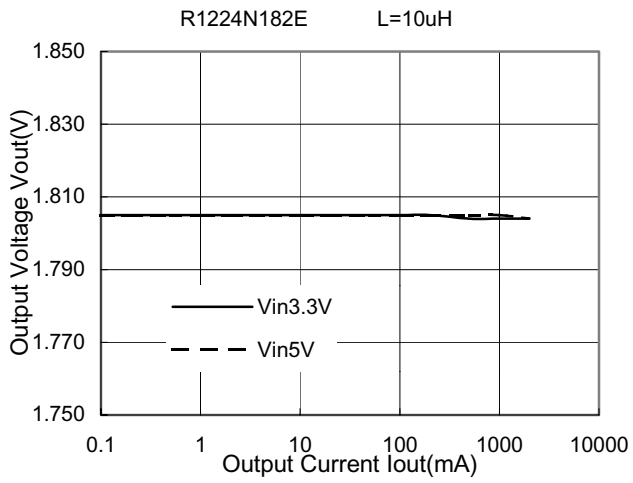

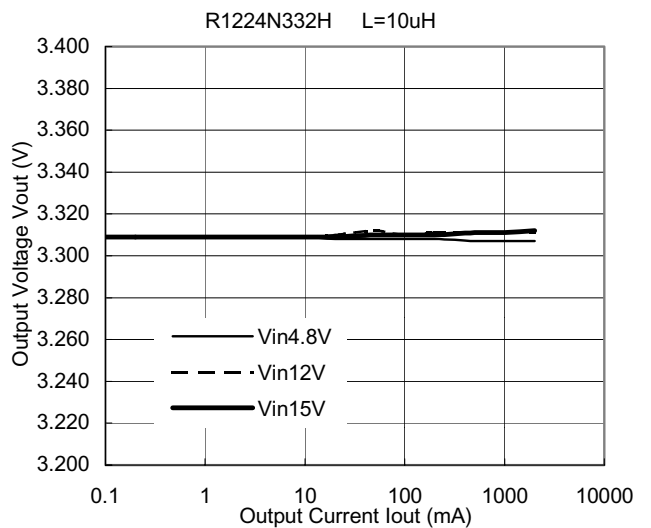
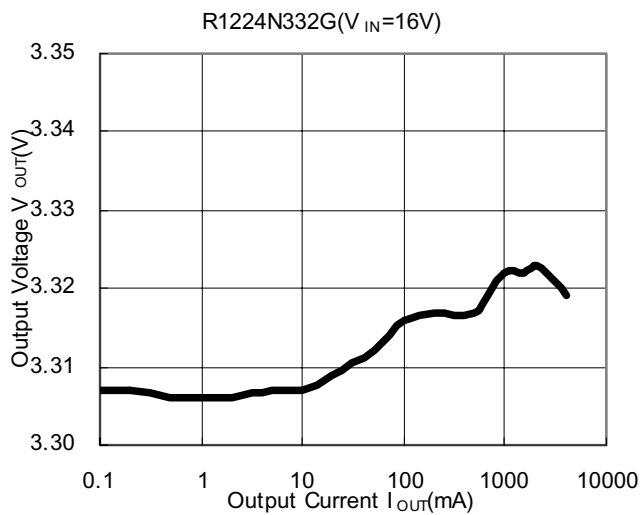
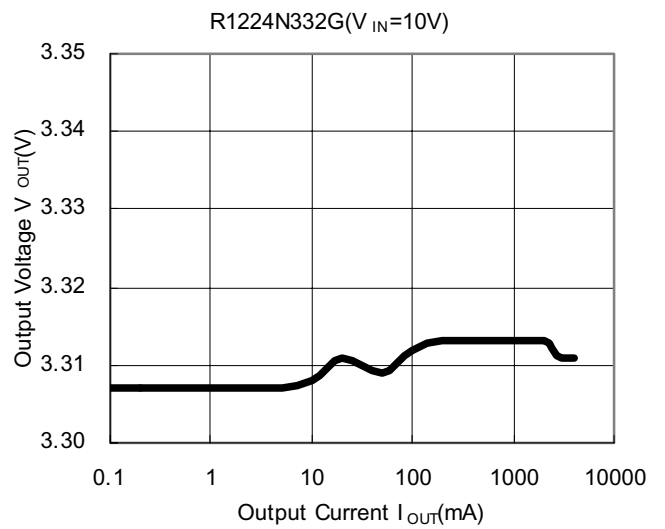
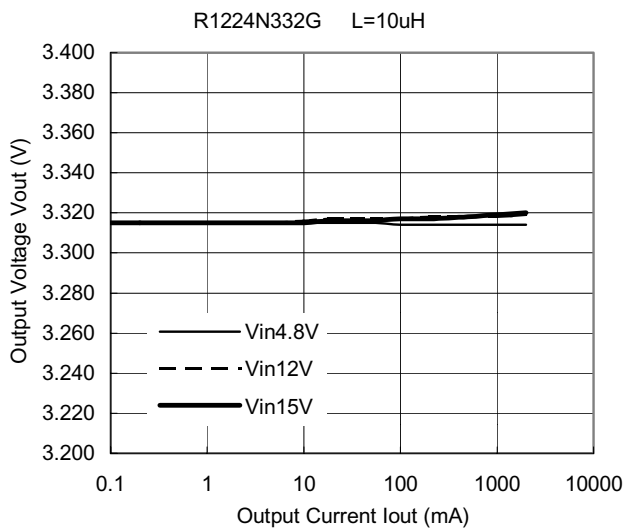
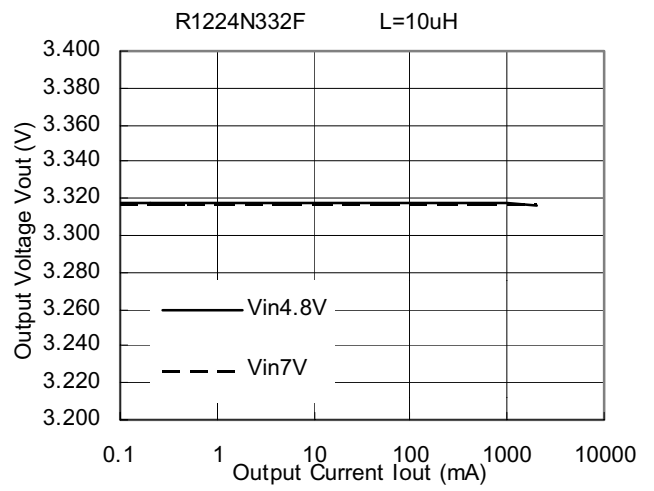
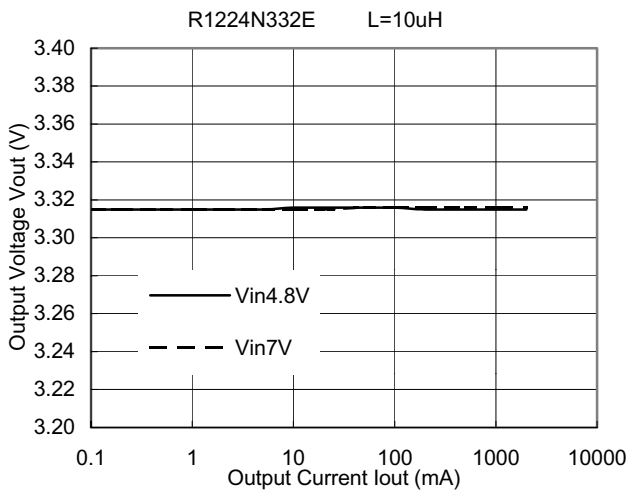

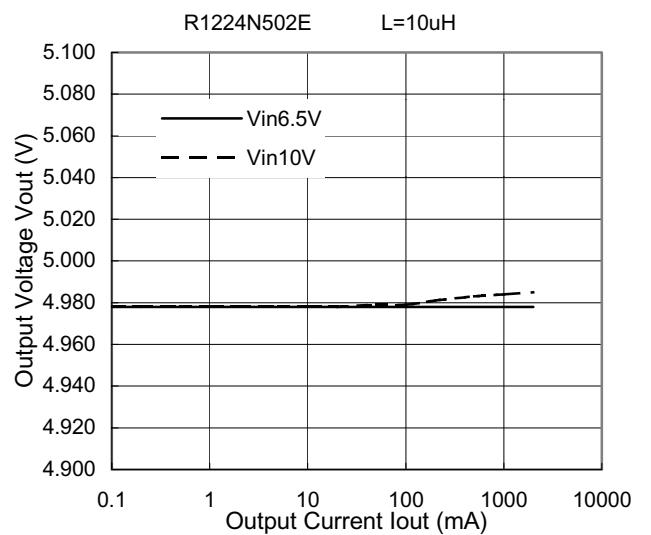
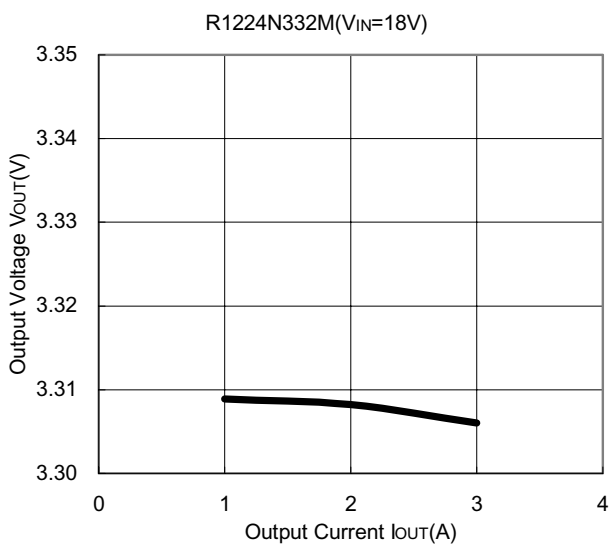
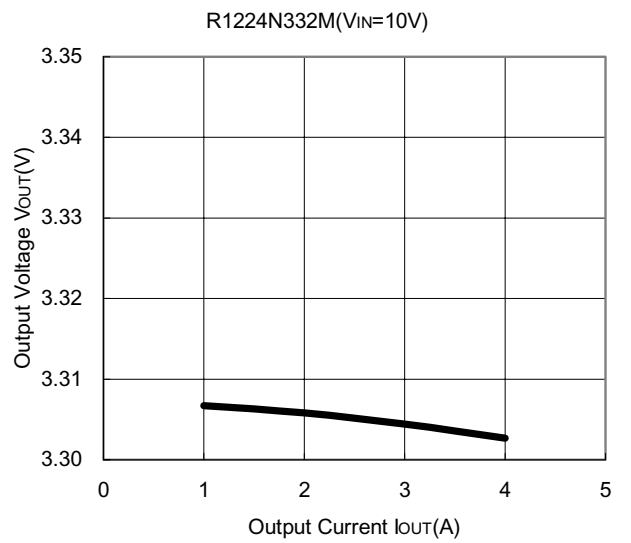
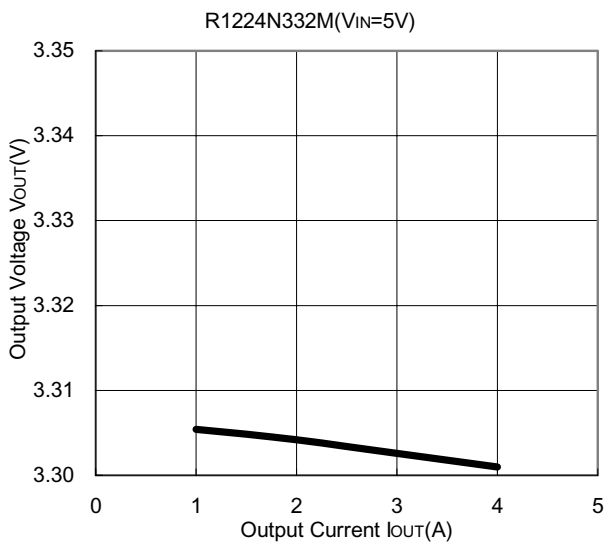
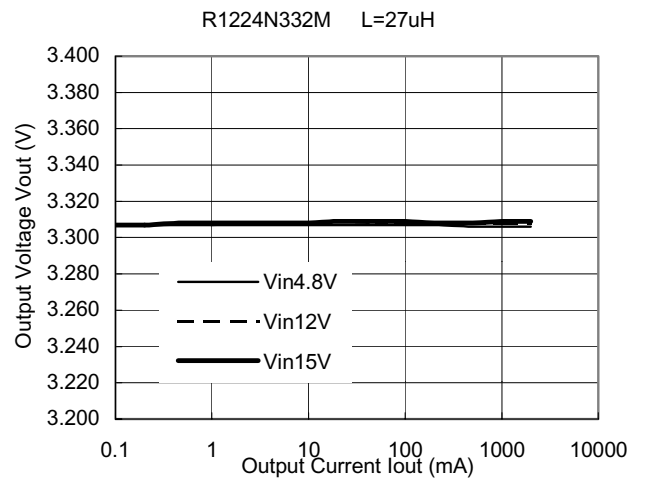
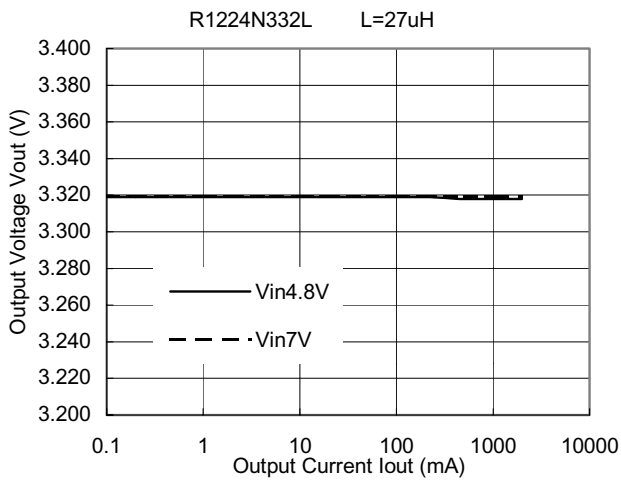

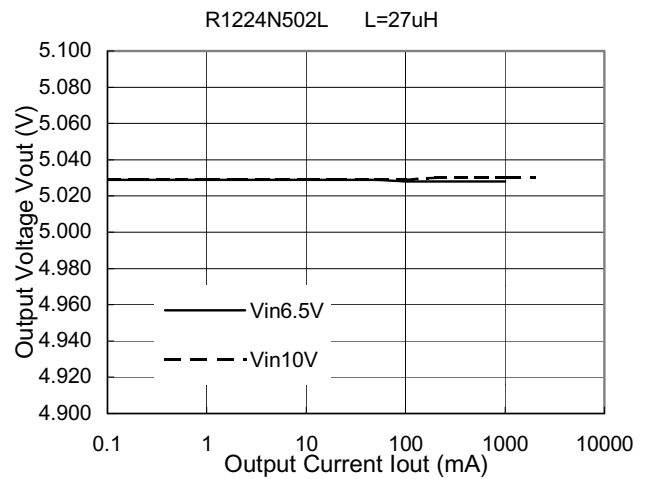
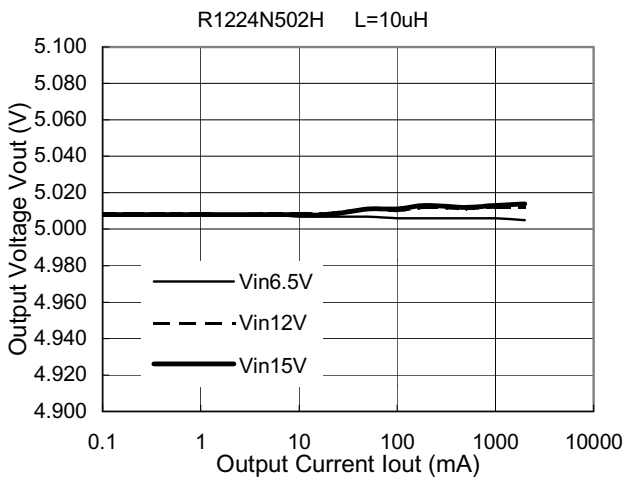
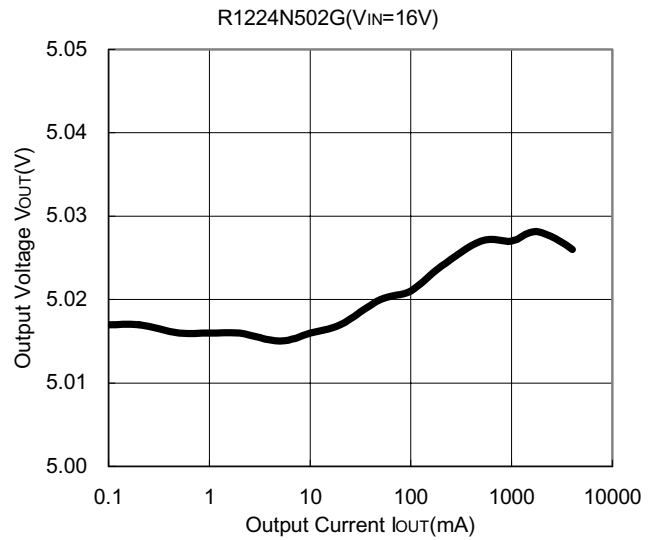
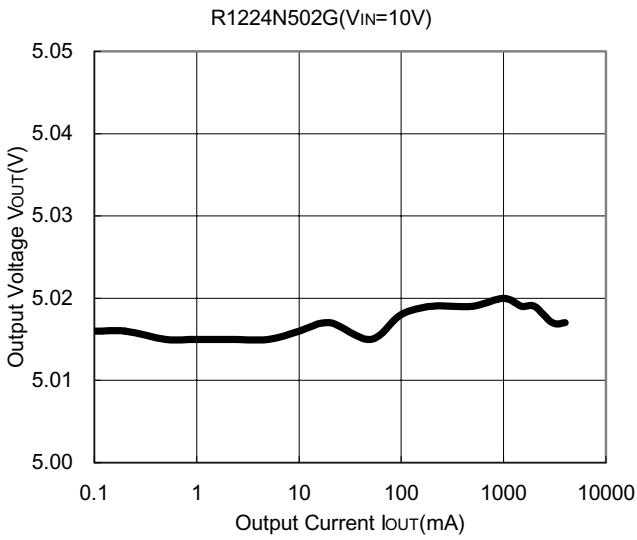
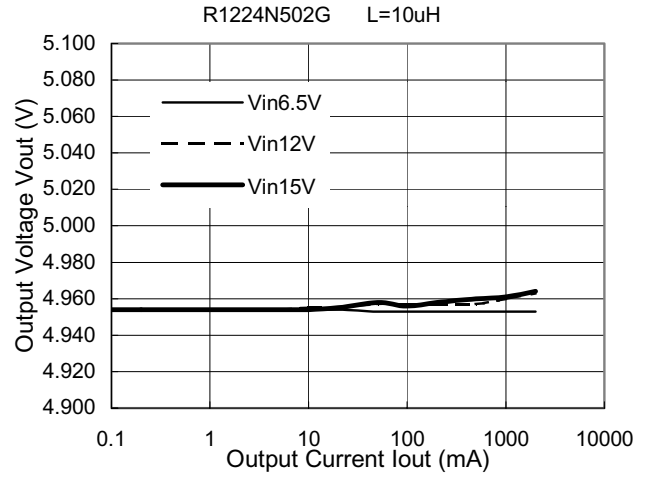
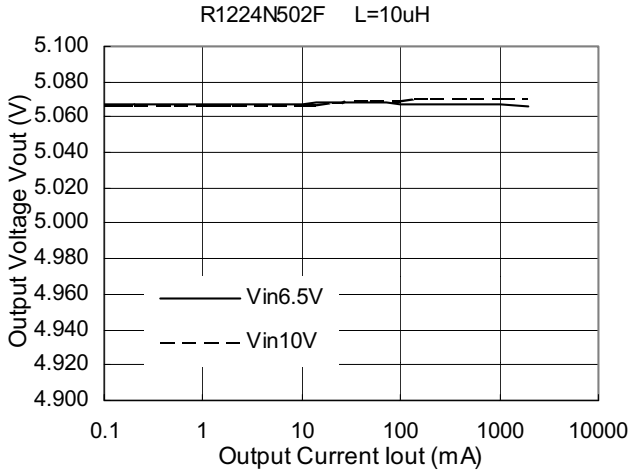

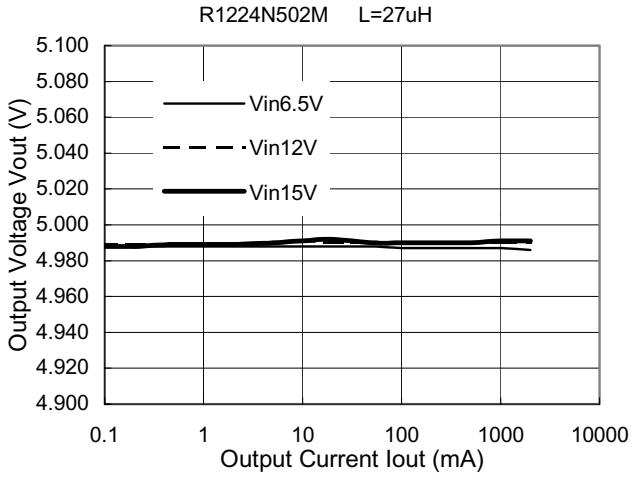

2) Efficiency vs. Output Current (*Note)

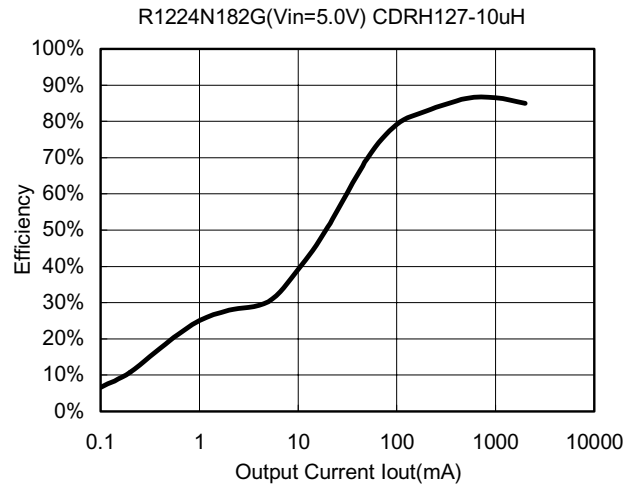
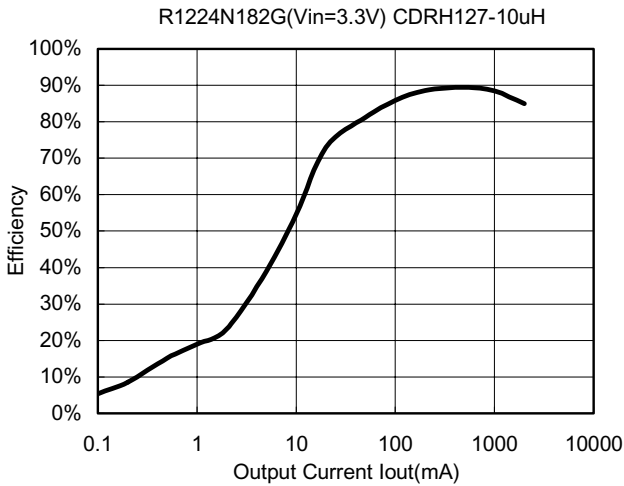
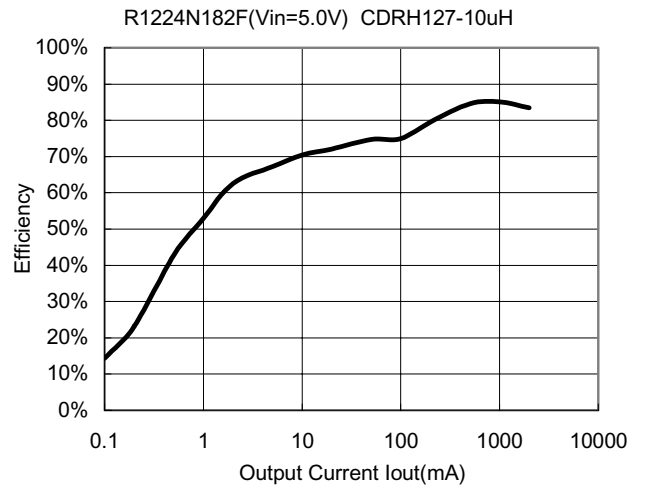
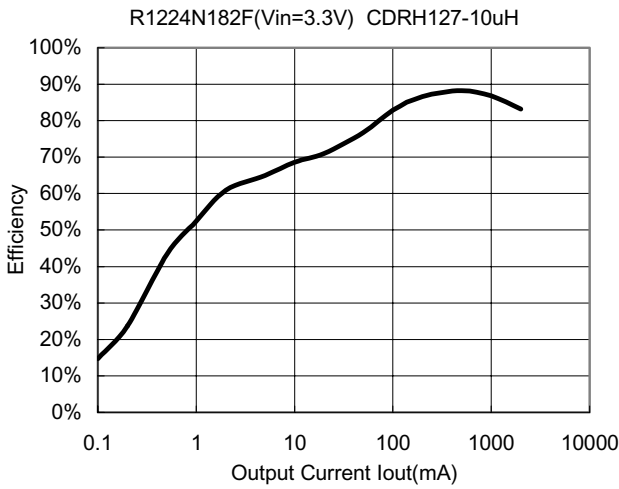

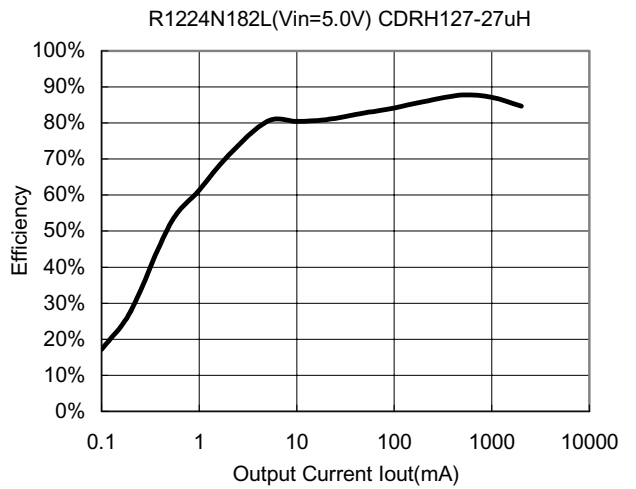
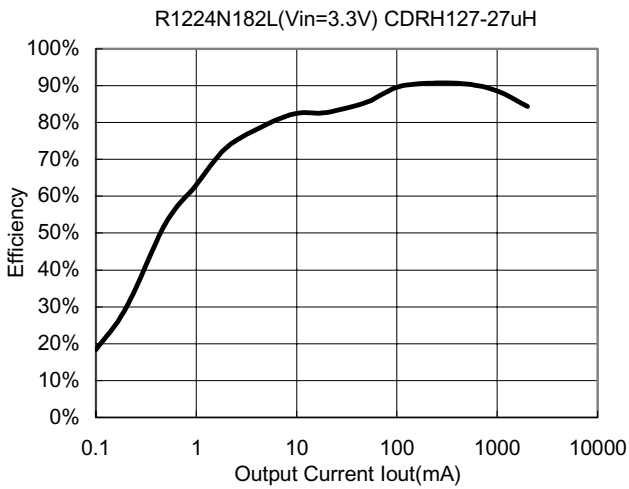
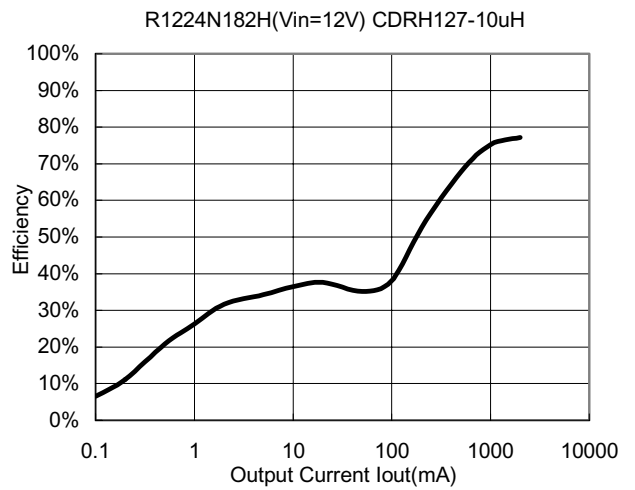
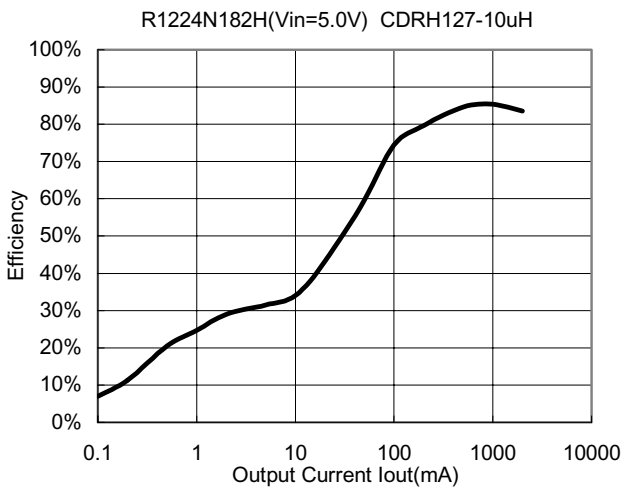
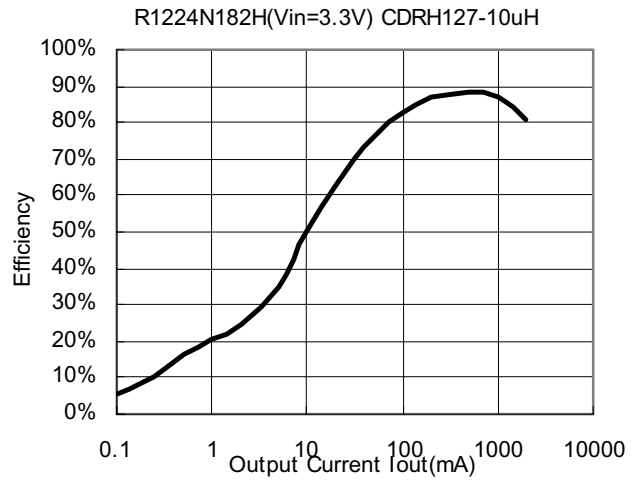
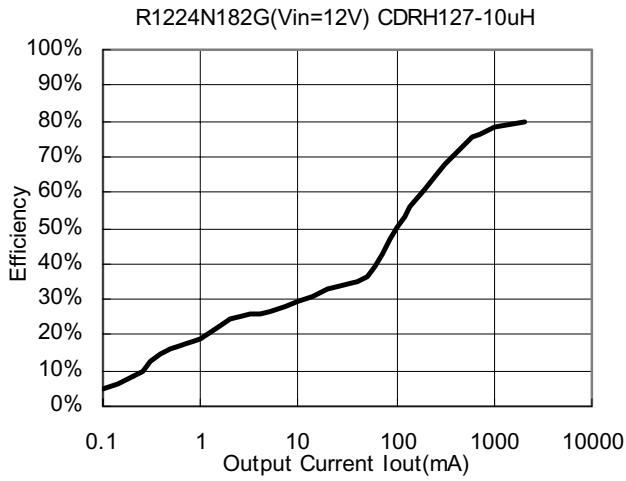

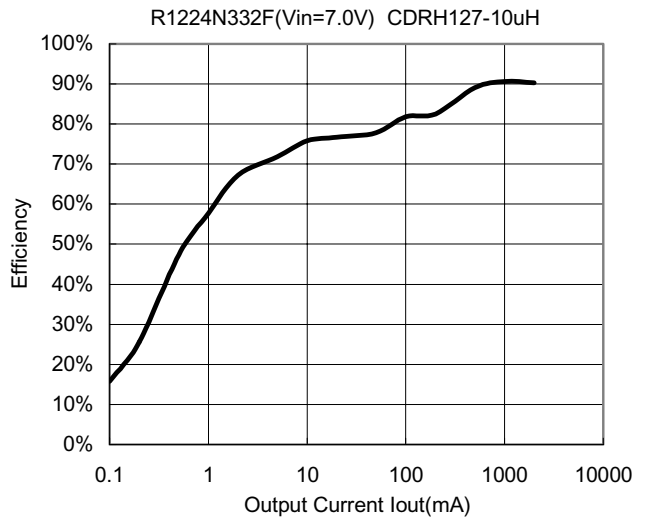
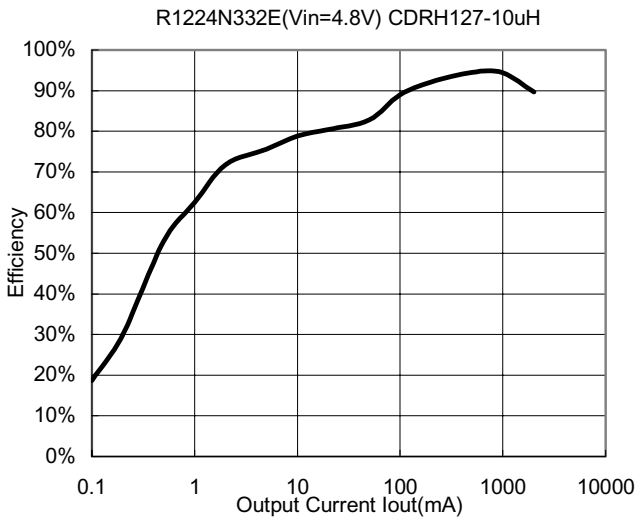
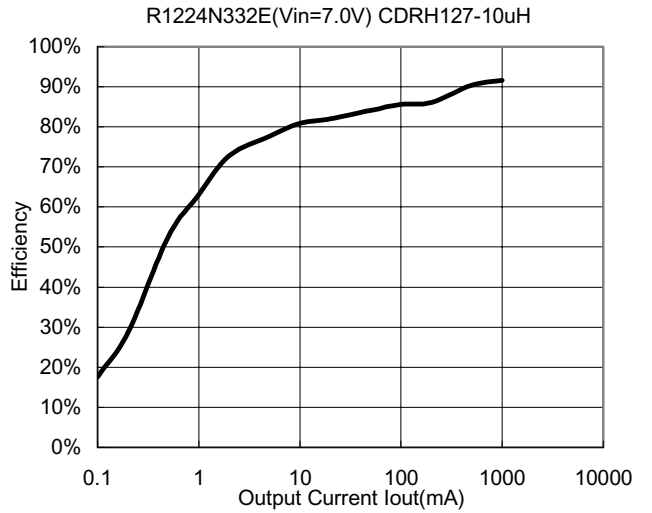
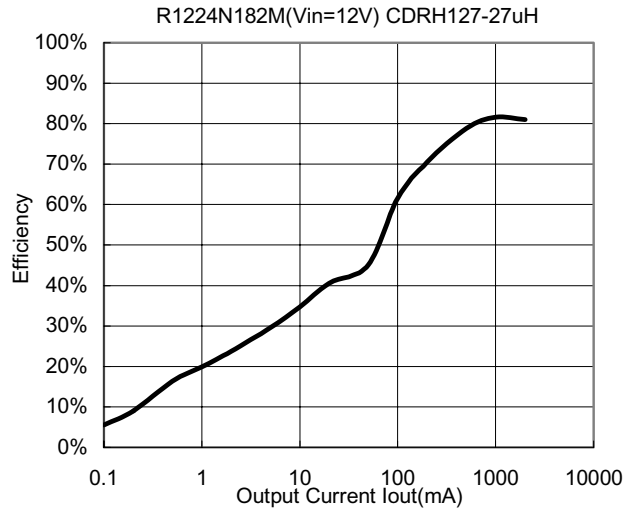
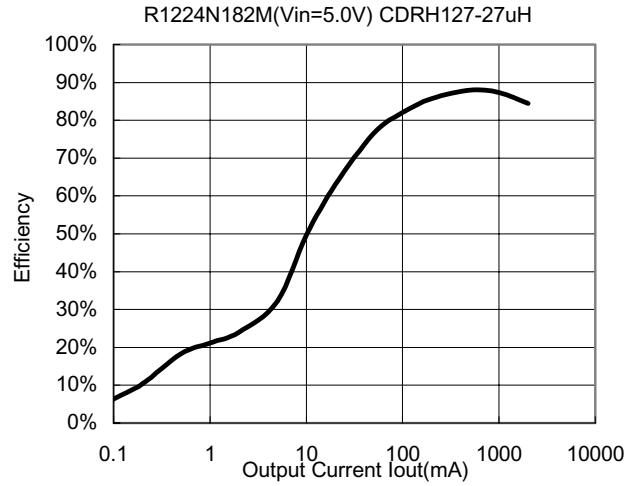
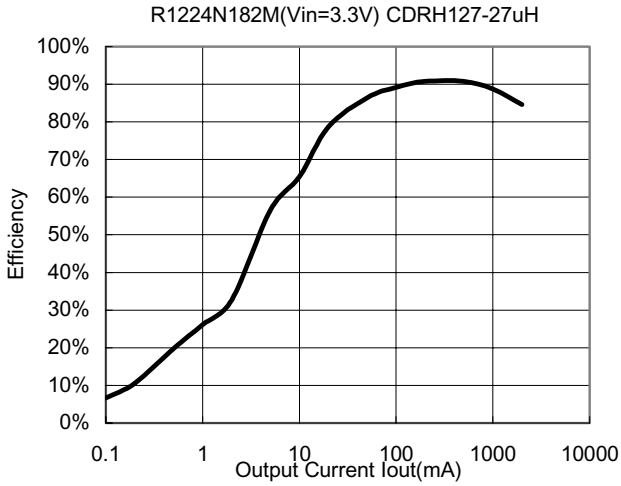

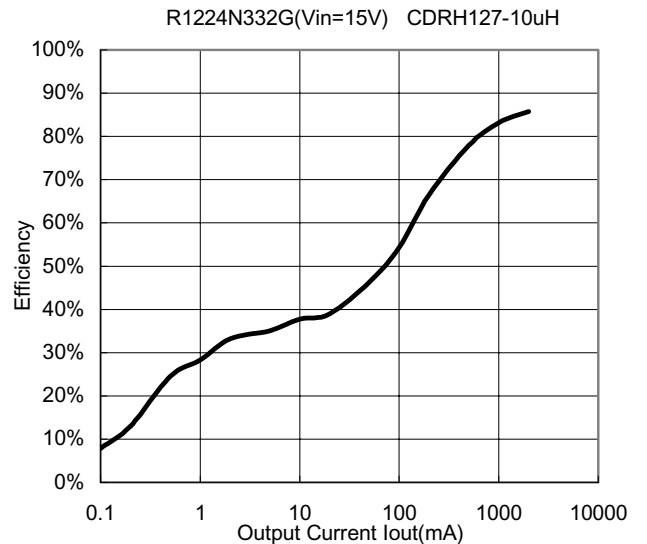
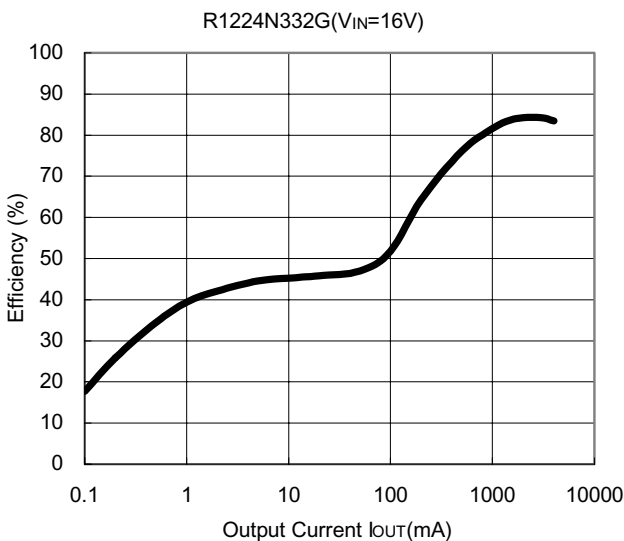
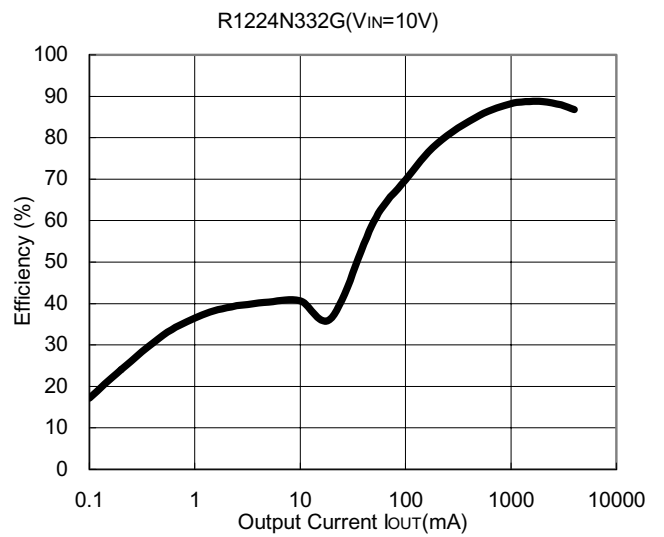
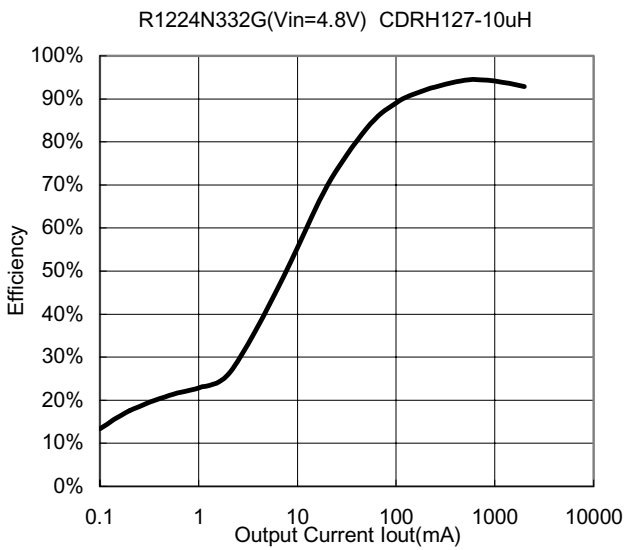
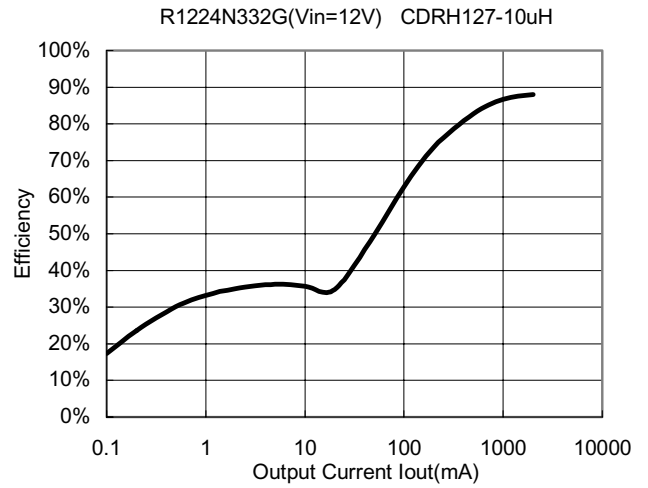
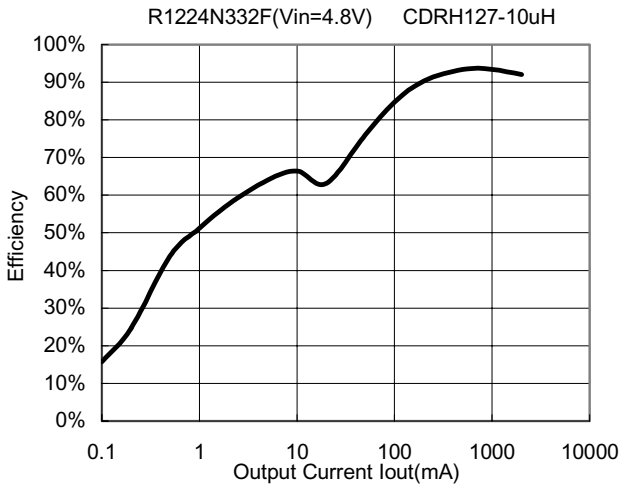

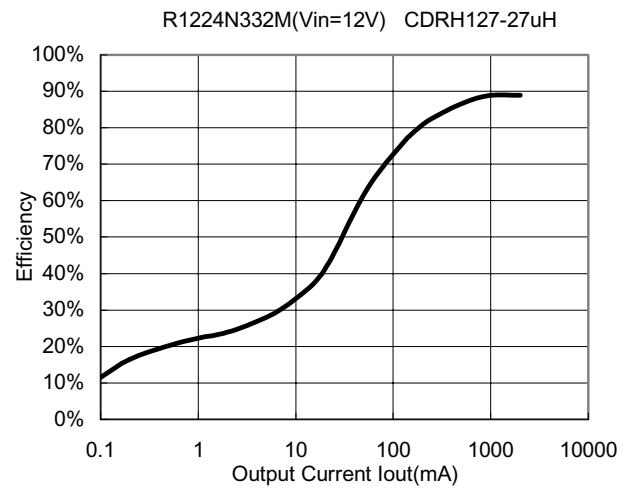
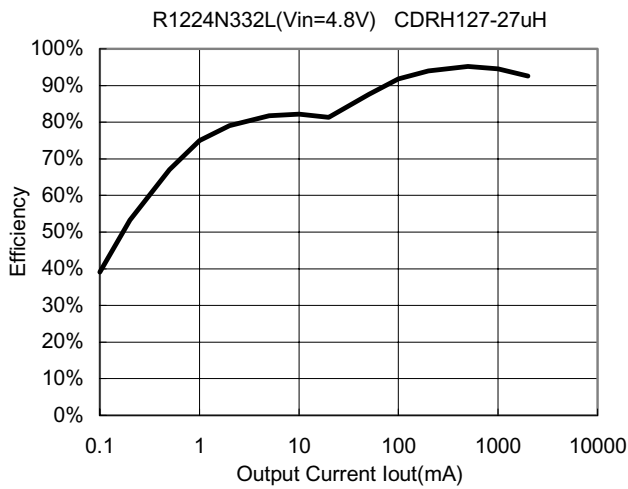
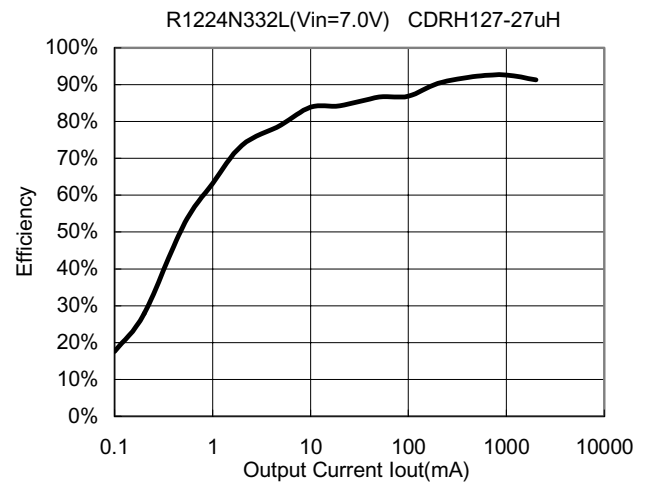
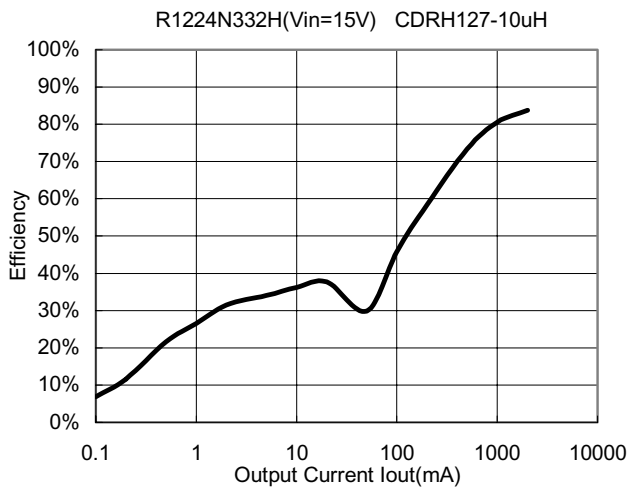
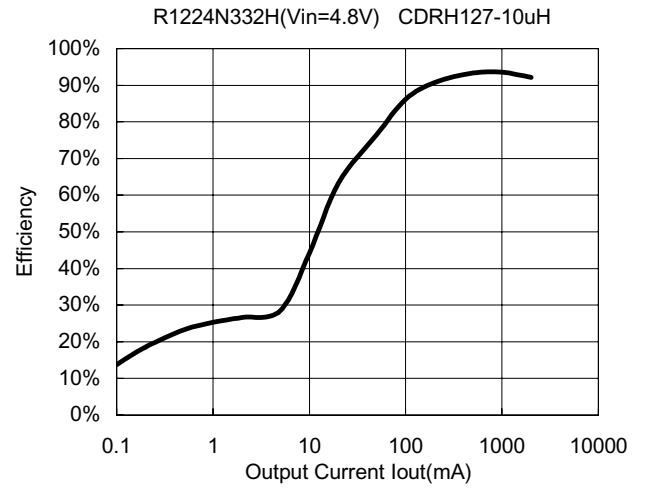
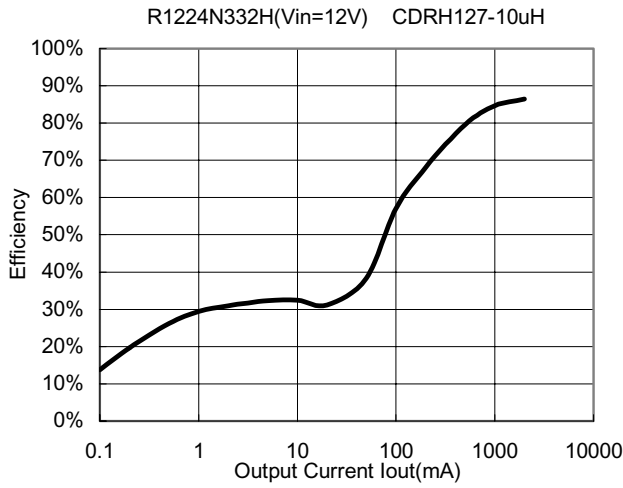

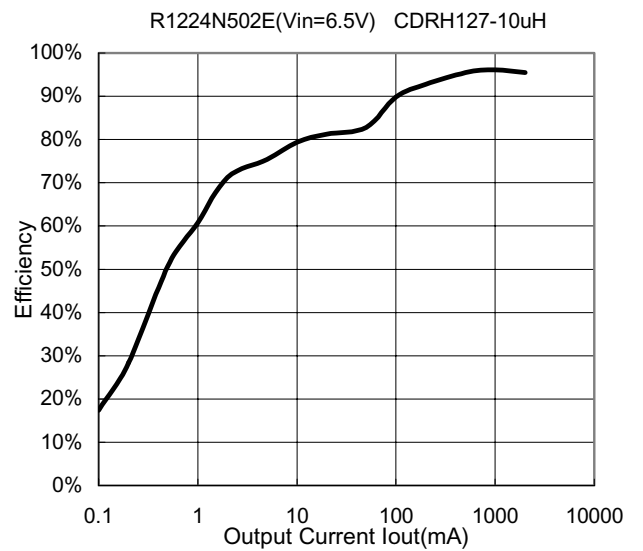
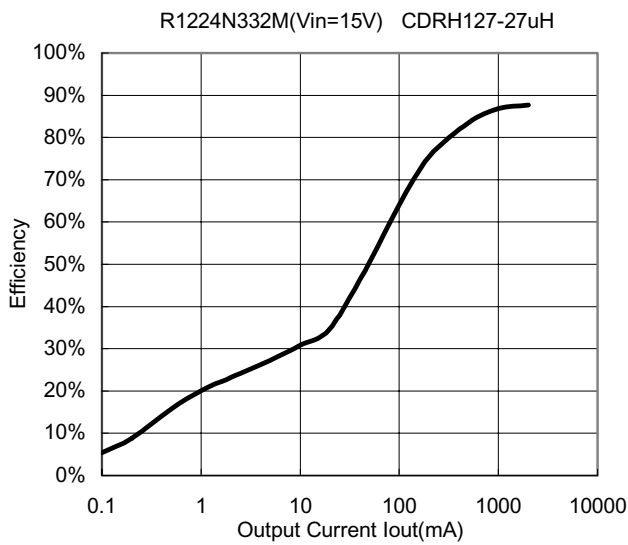
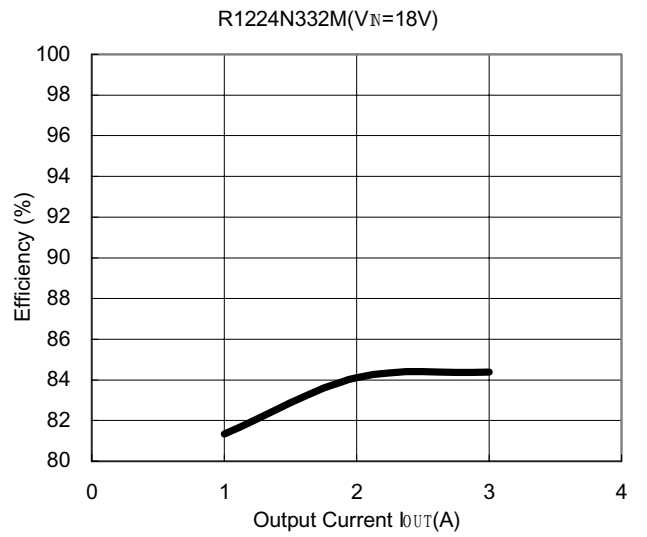
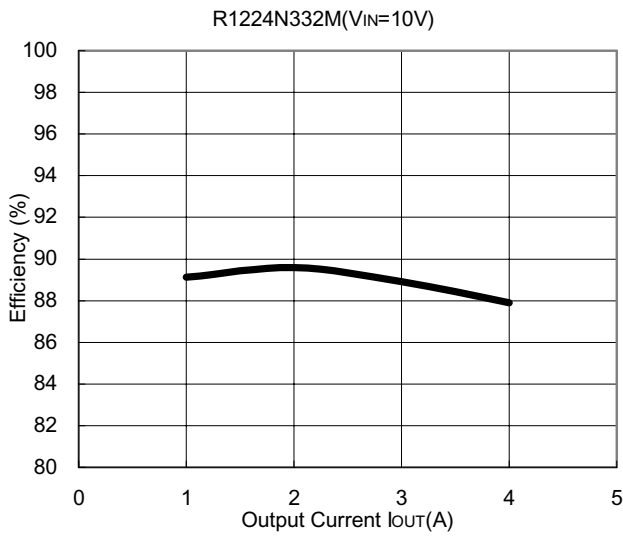
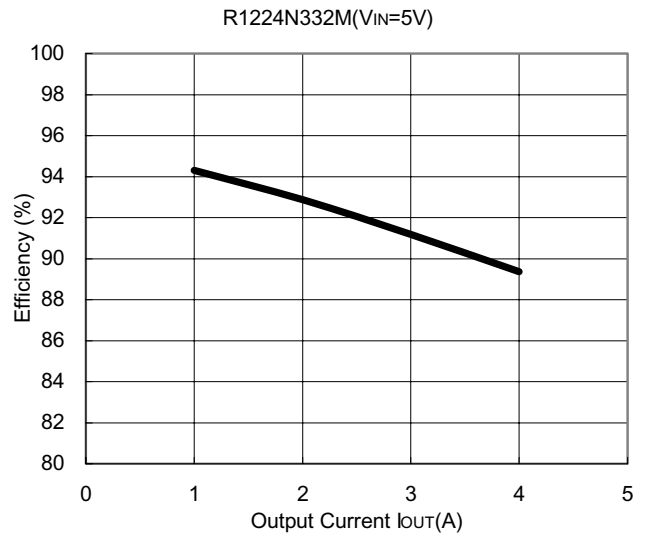
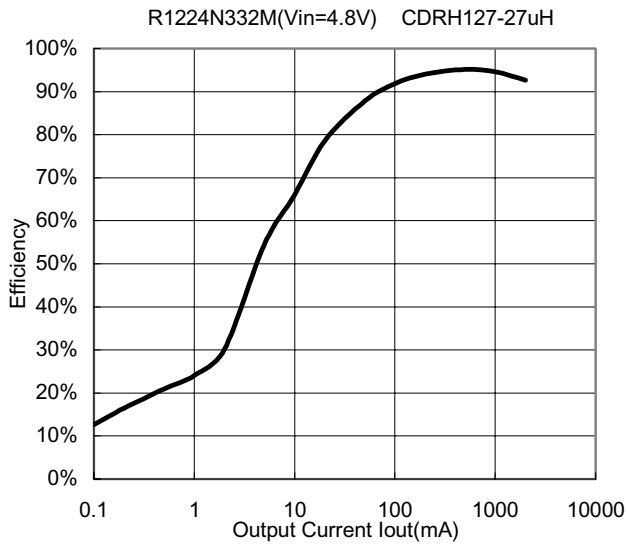

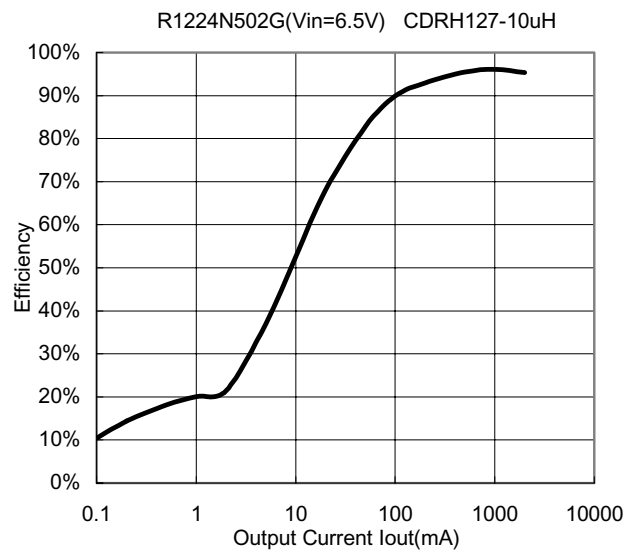
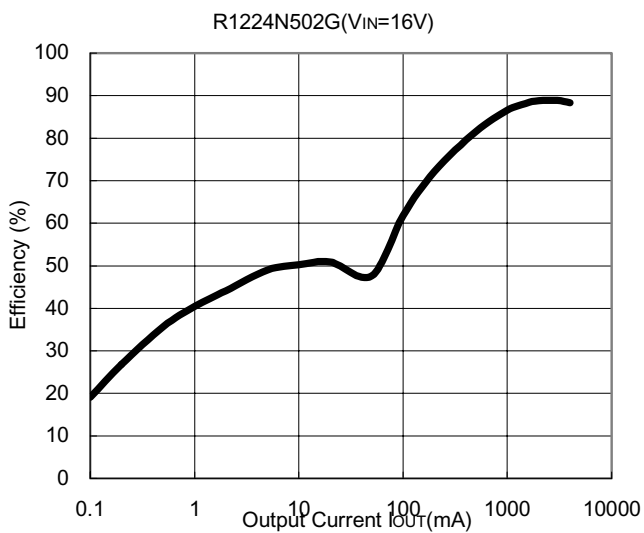
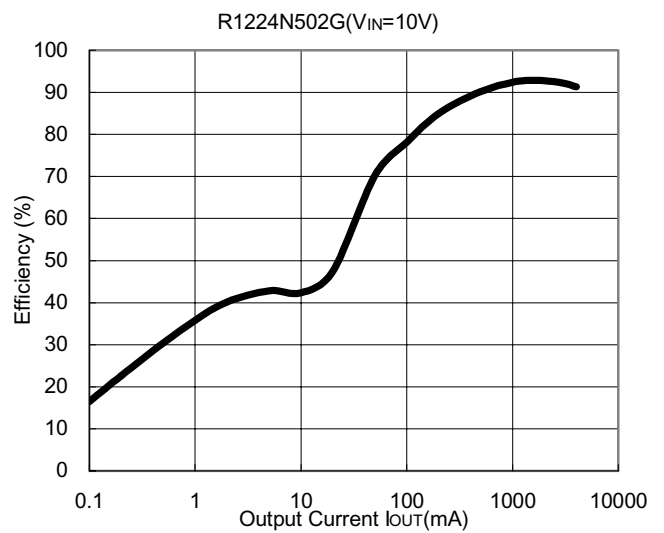
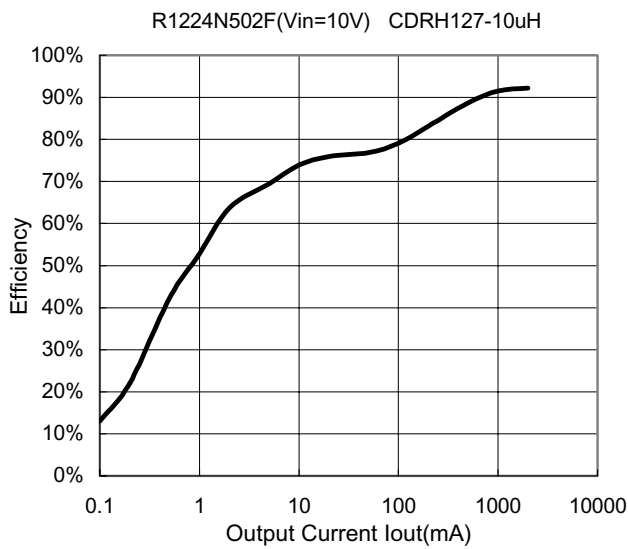
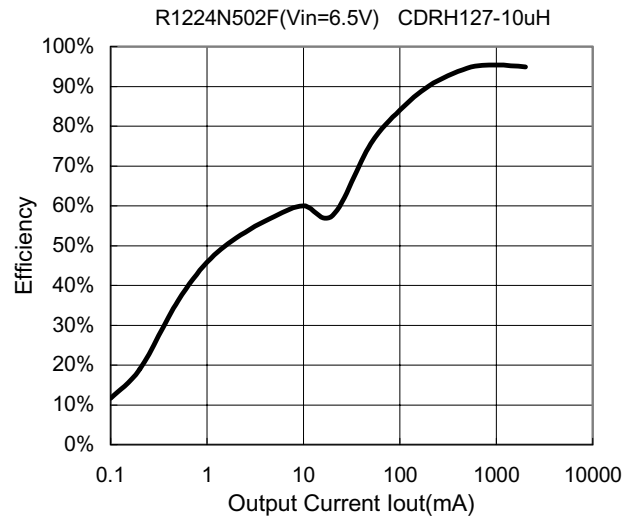
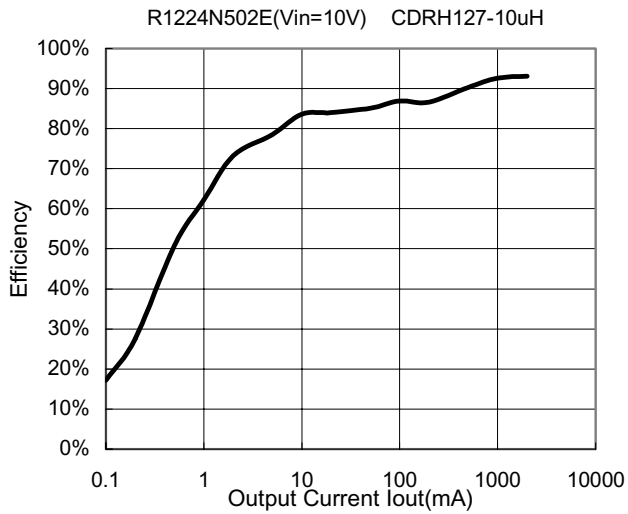

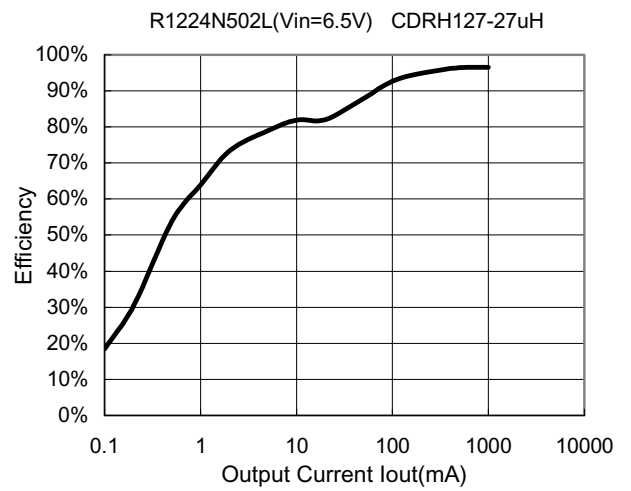
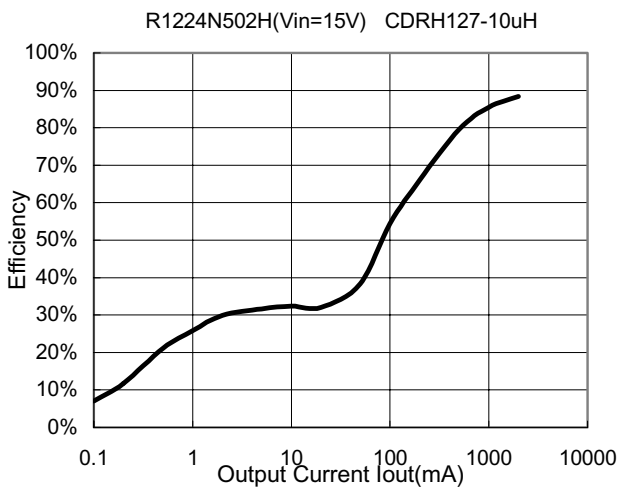
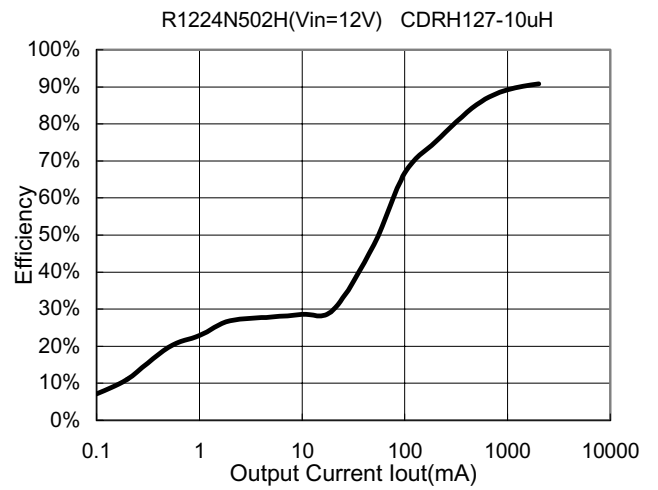
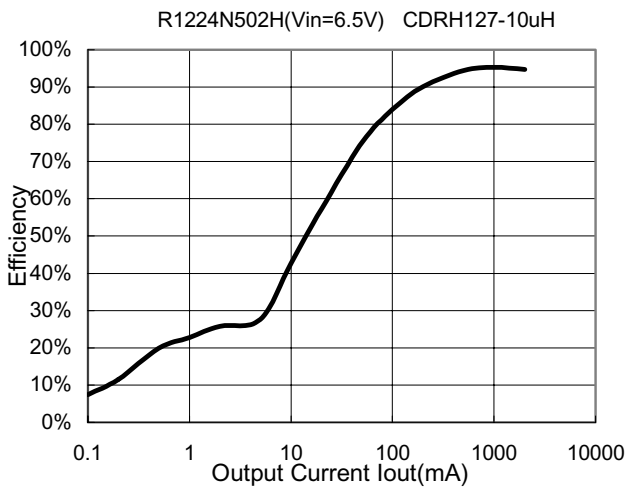
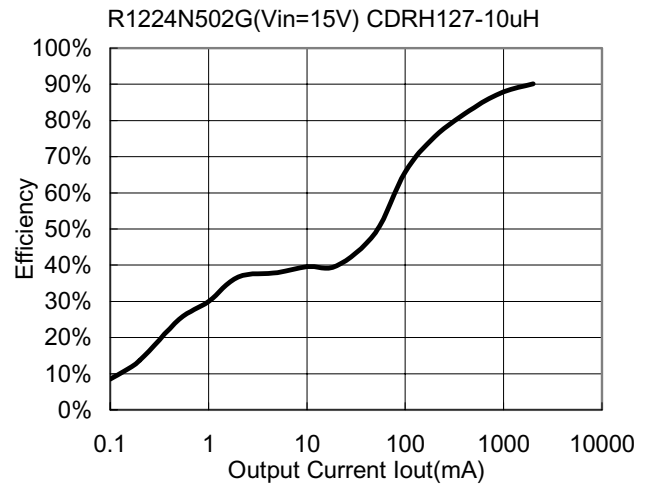
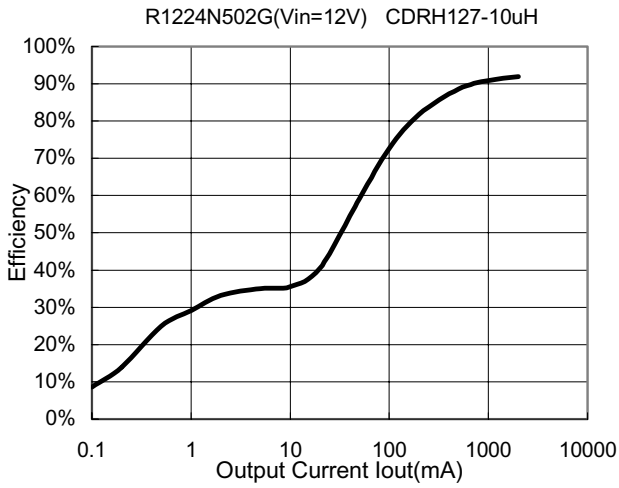

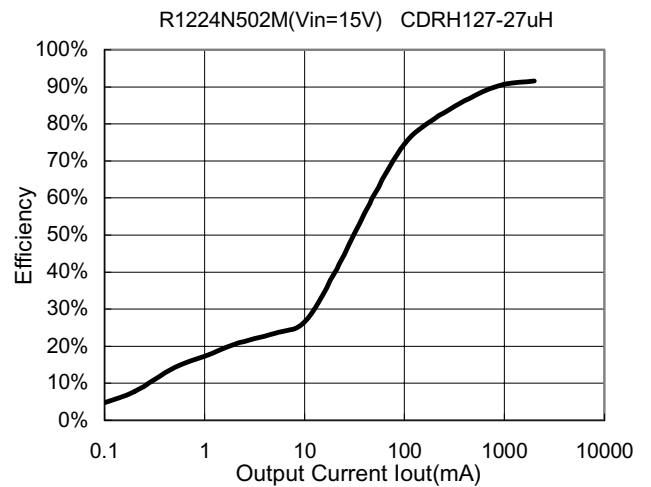
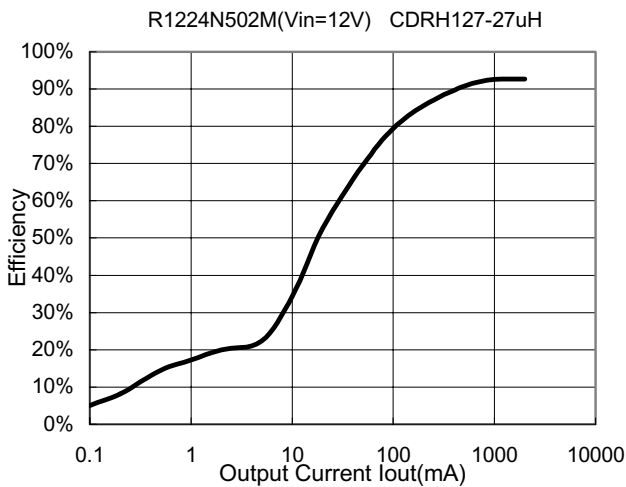
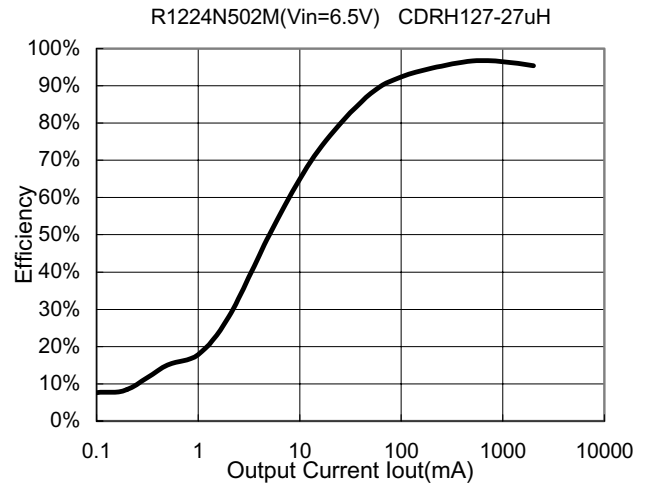
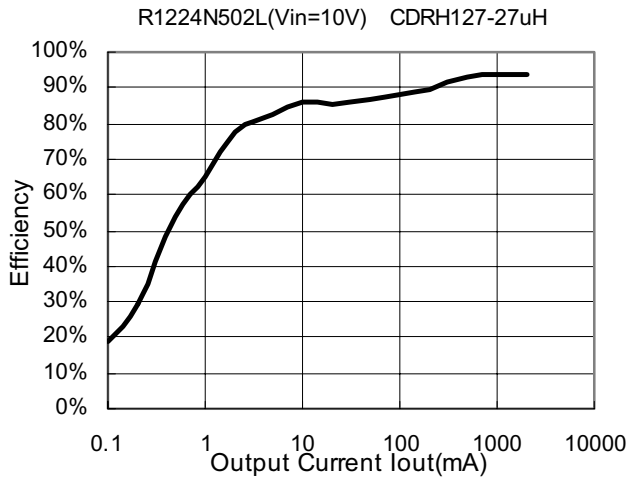

***Note: Typical characteristics 9), 10) are obtained with using the following components;**

PMOS: IRF7406 (IR)

L: CDRH127-100MC (Sumida: 10μH)

C2: 0.1μF (Ceramic Type)

SD: RB083L-20 (Rohm)

C3: 10SA220(Sanyo/OS-con: 220μF/10V)

C1: 25SC47(Sanyo/OS-con: 47μF/25V)×2

R1: 10Ω

3) Ripple Voltage vs. Output Current

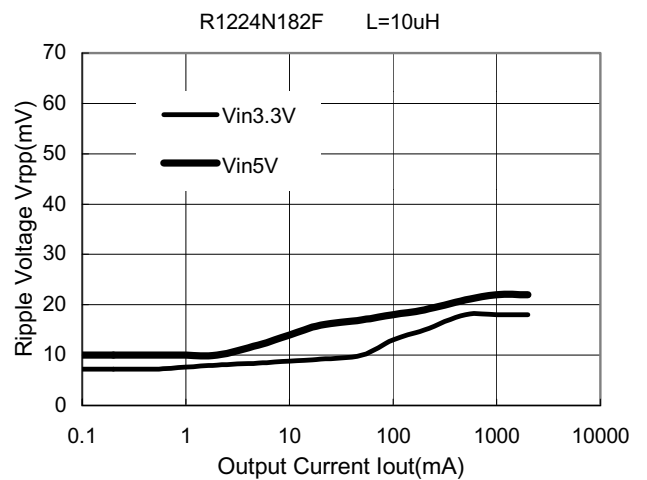
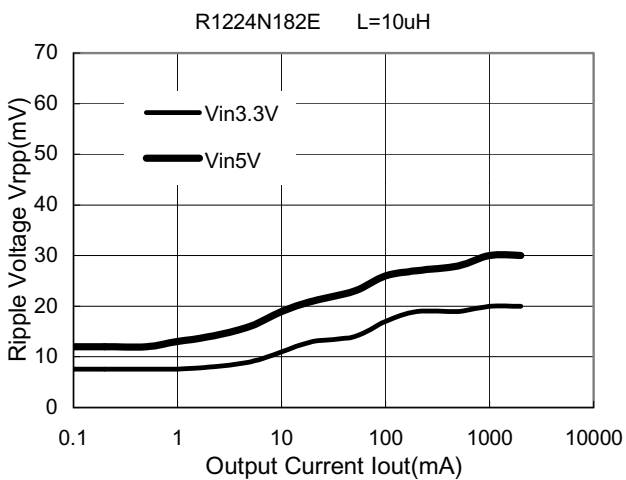

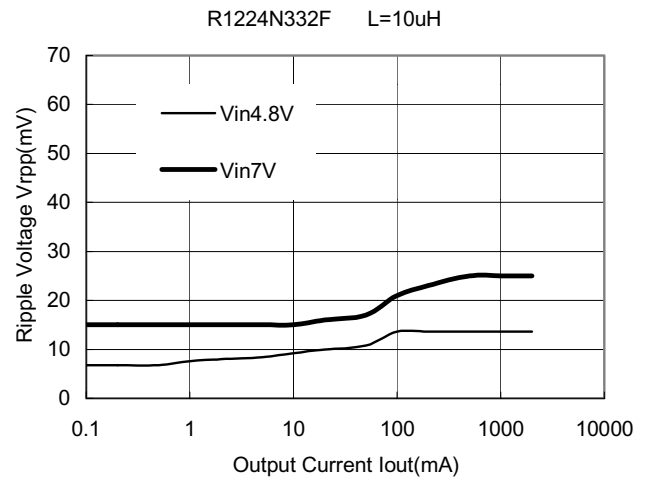
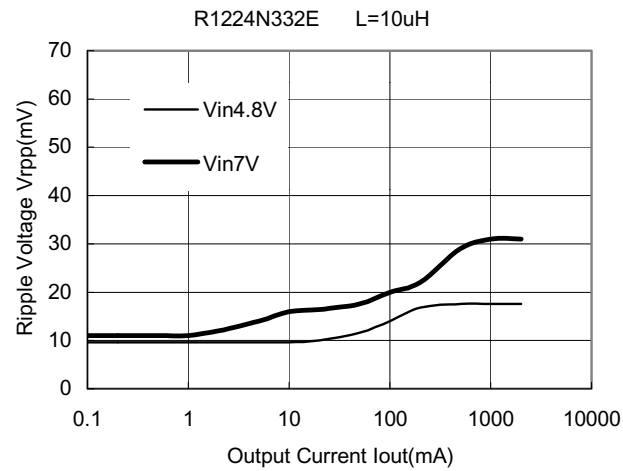
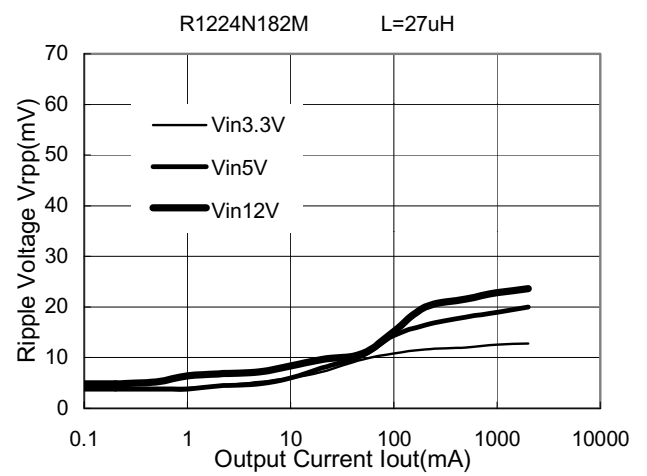
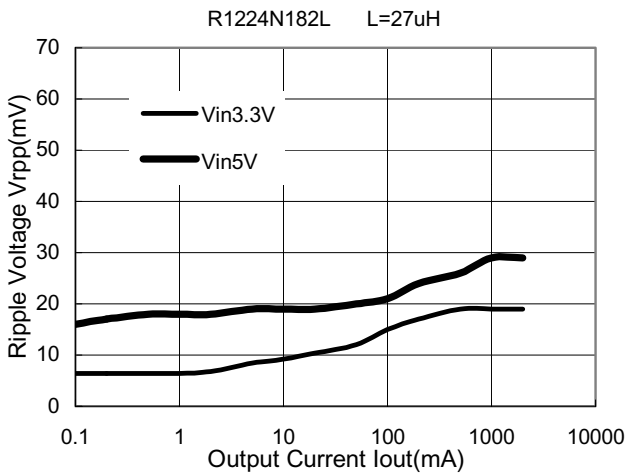
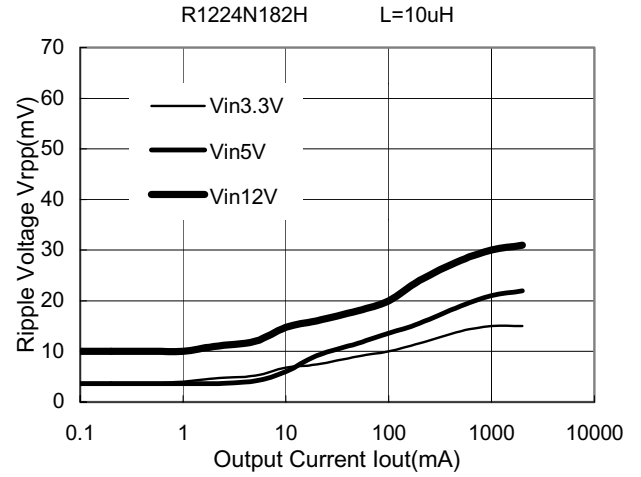
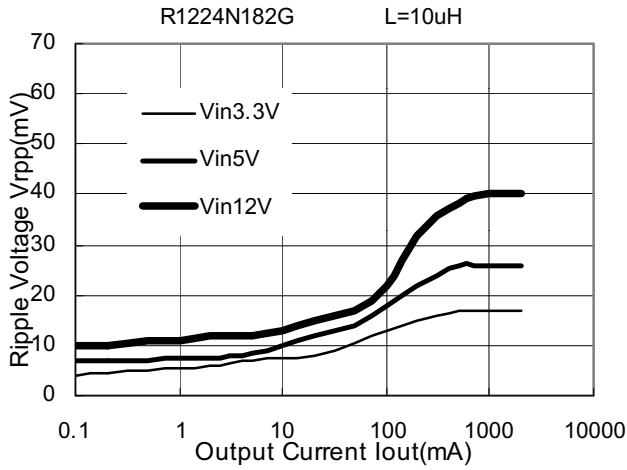

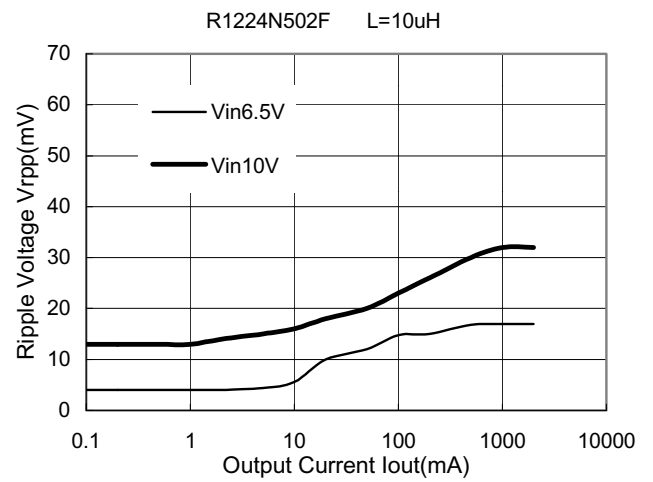
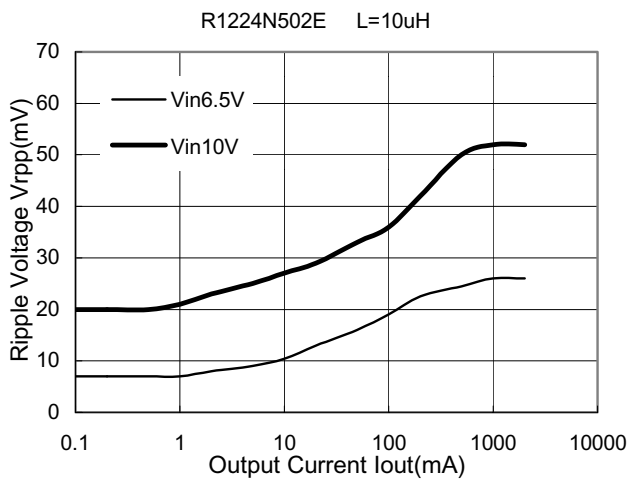
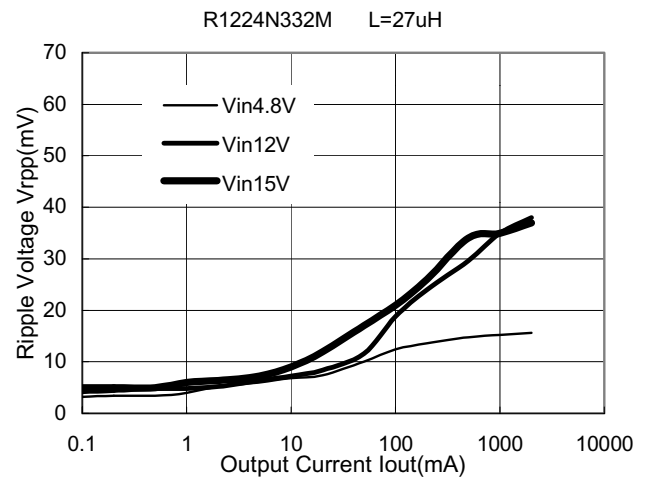
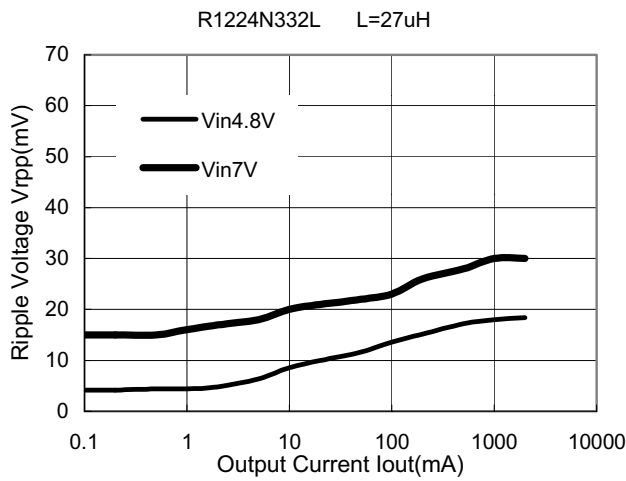
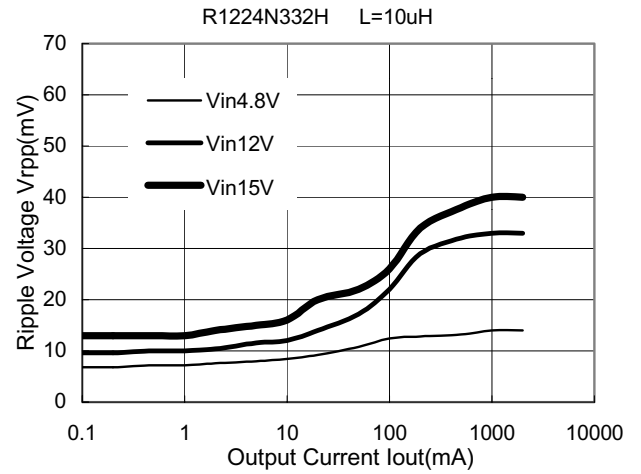
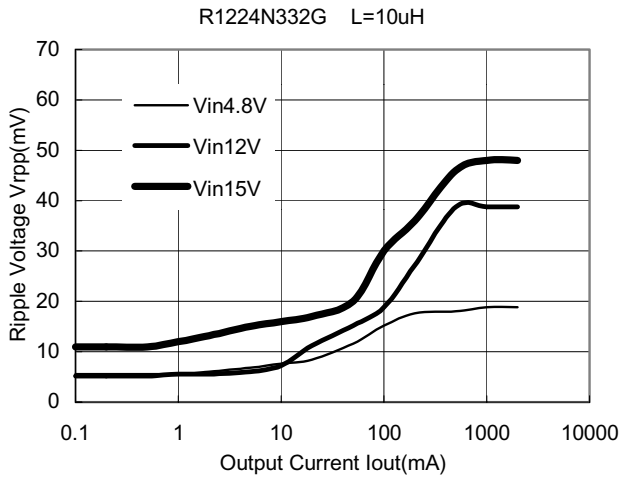

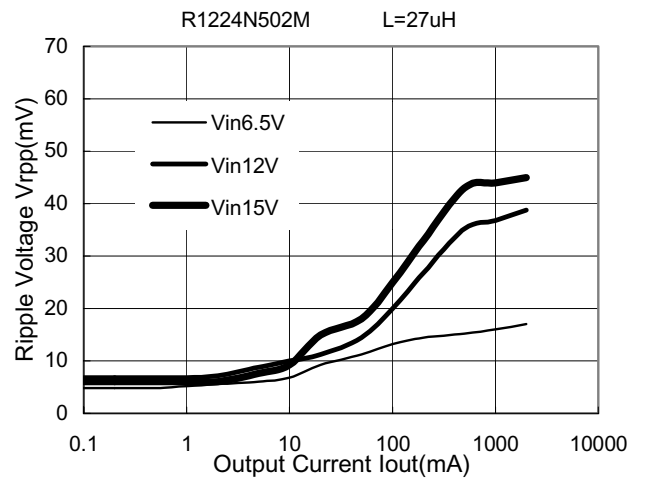
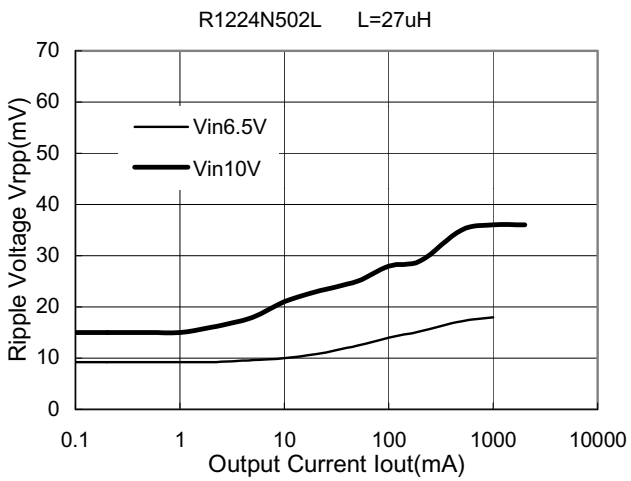
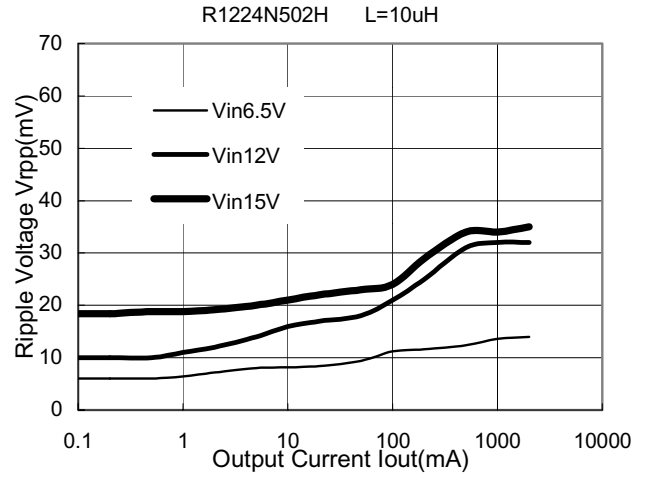
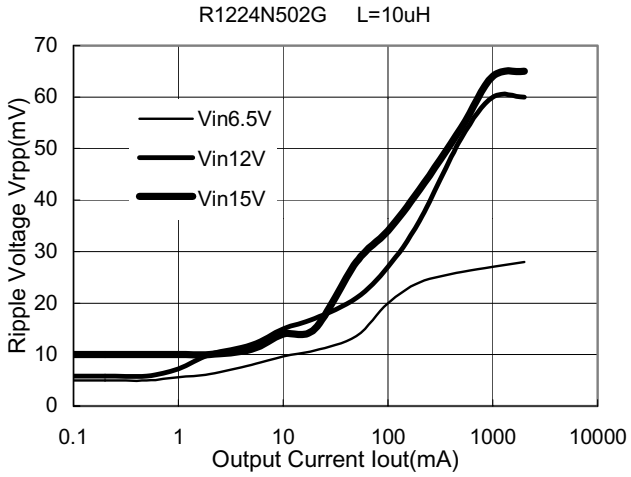

4) Output Voltage vs. Input Voltage

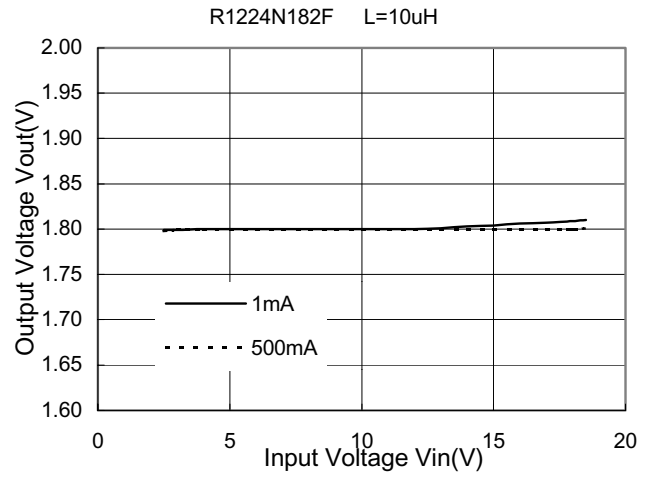
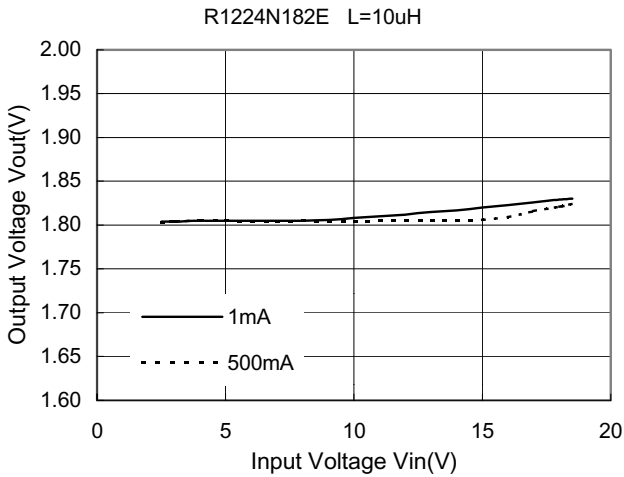

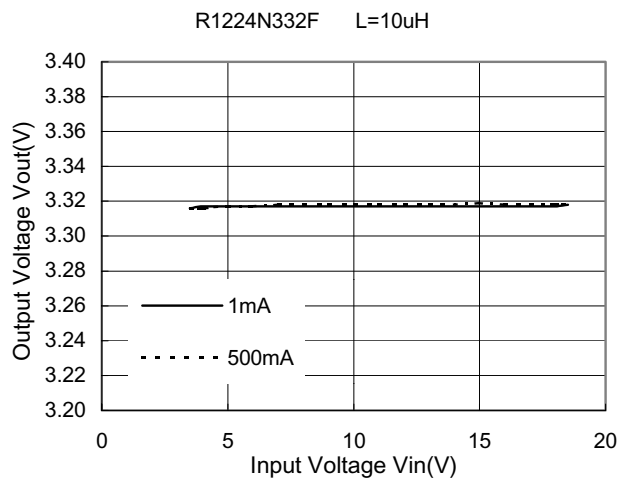
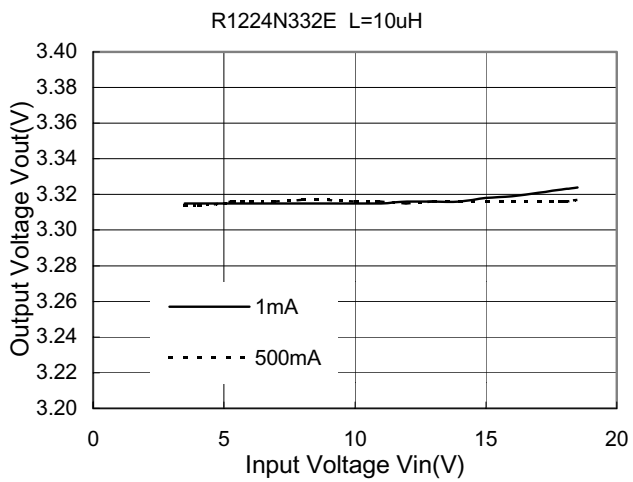
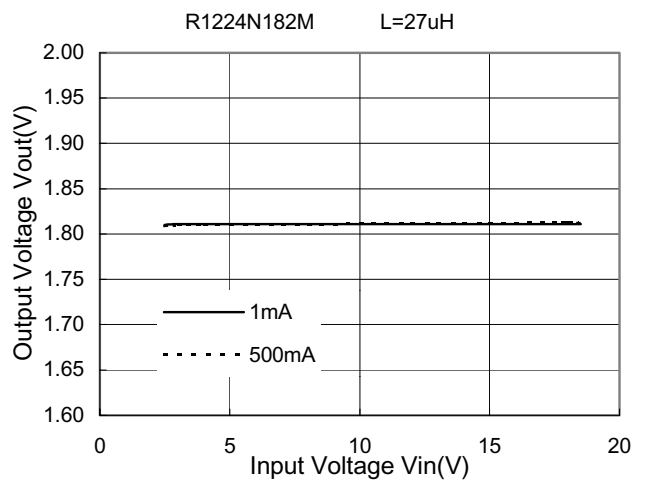
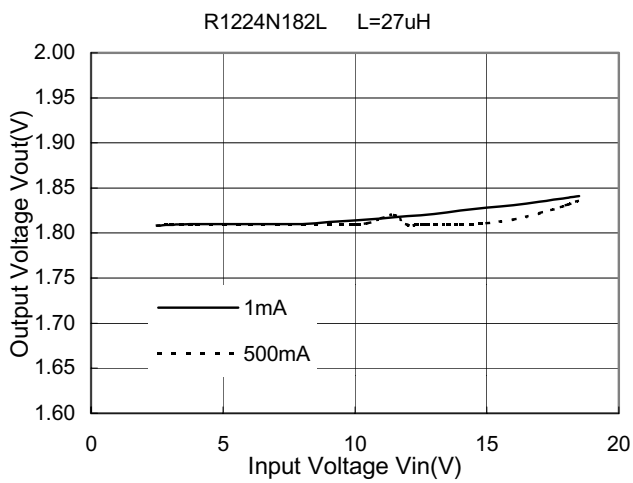
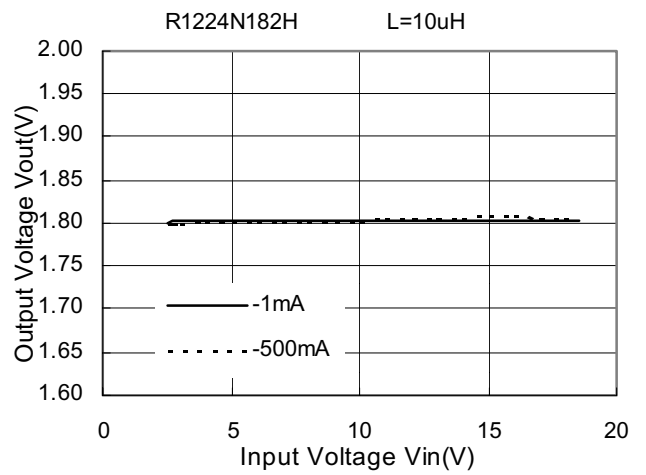
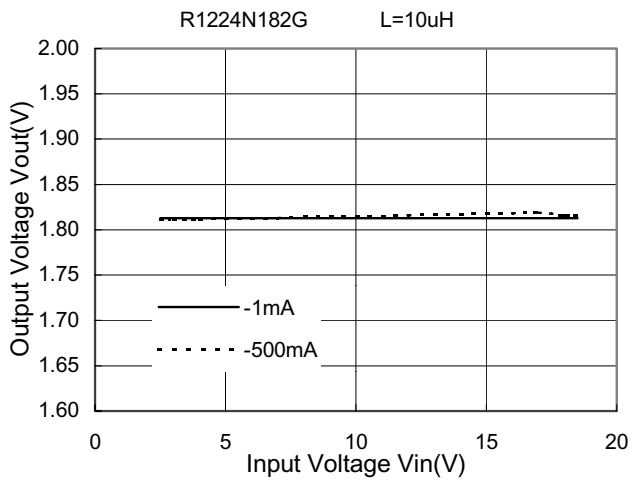

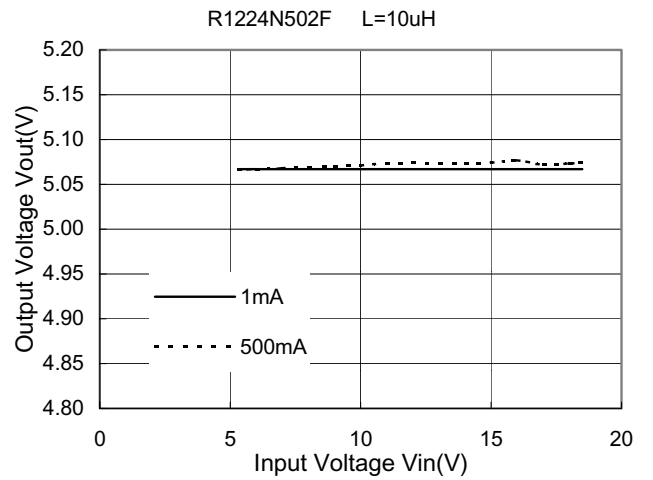
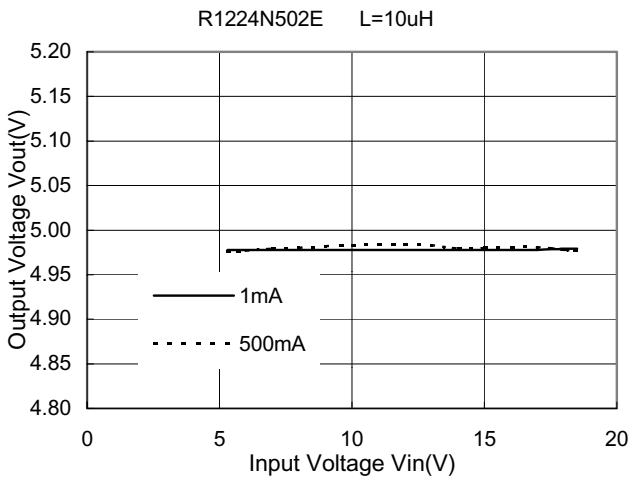
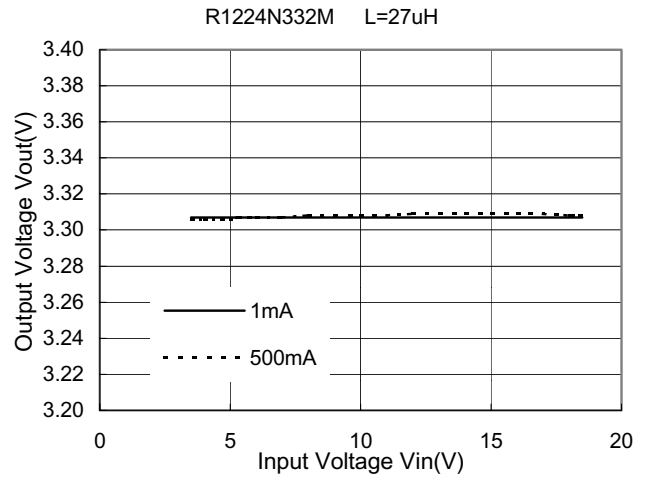
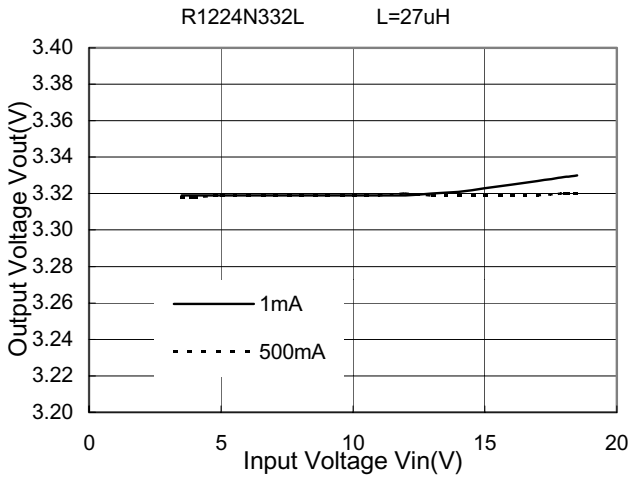
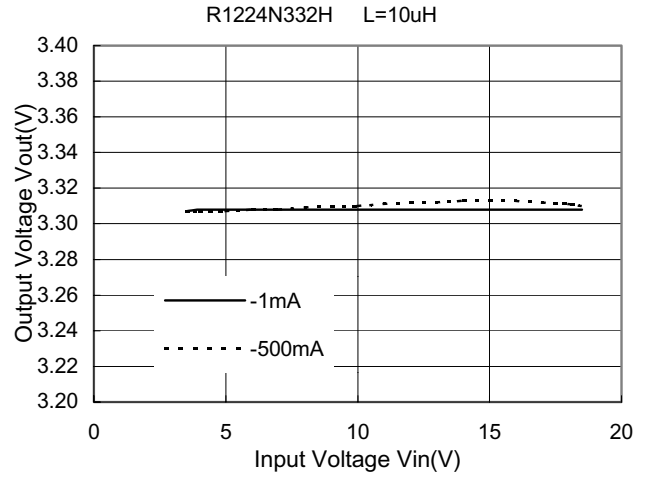
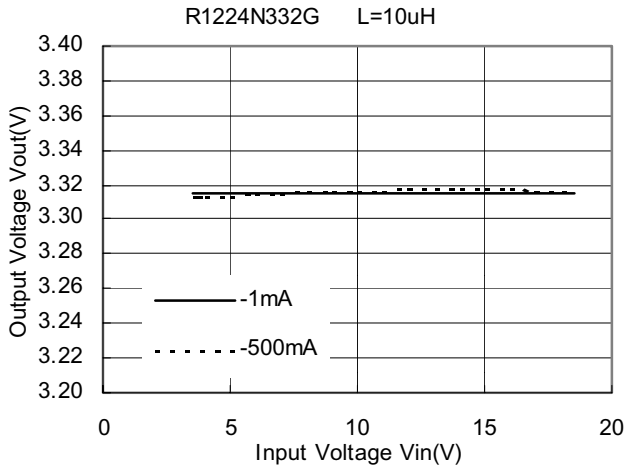

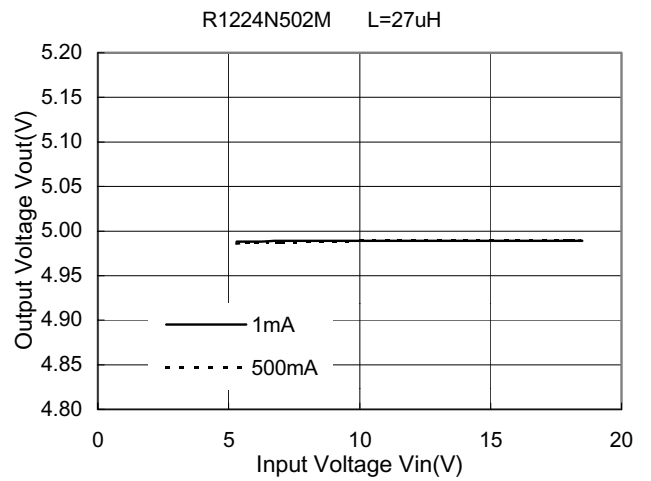
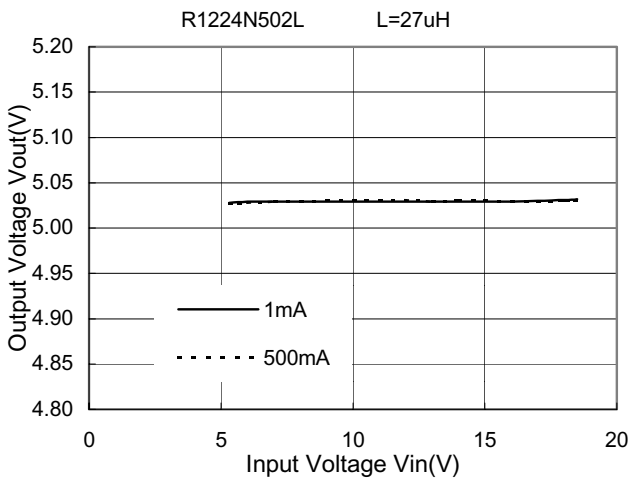
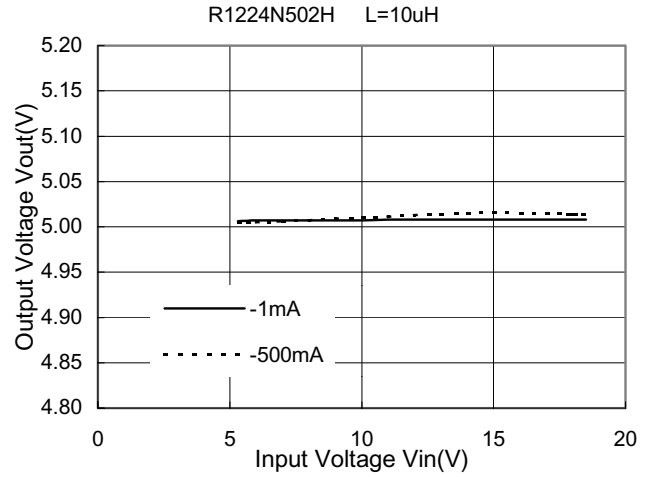
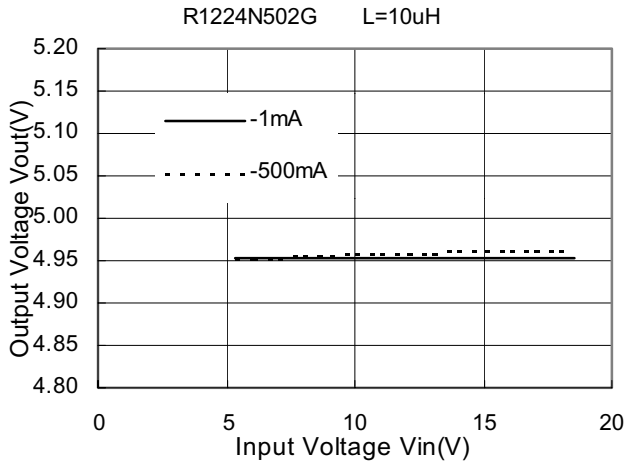

5) Output Voltage vs. Temperature

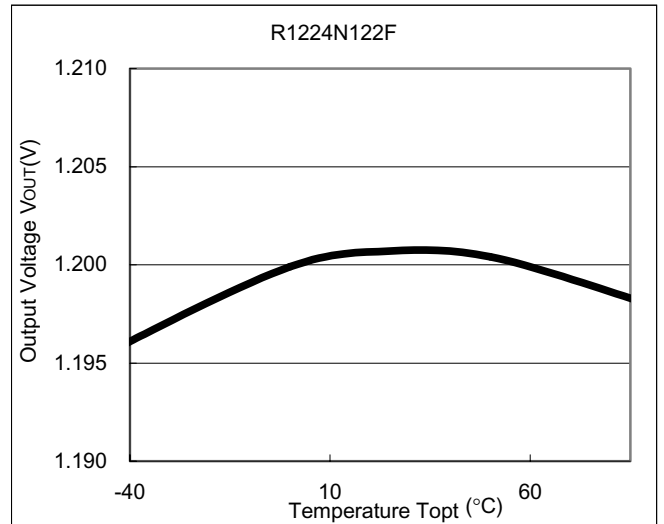
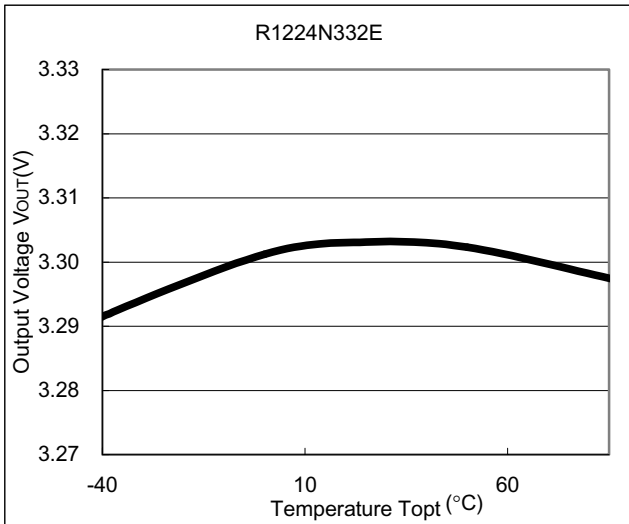

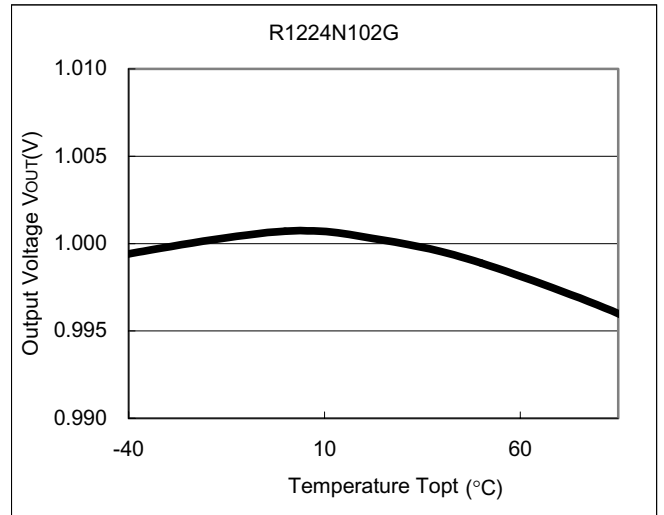
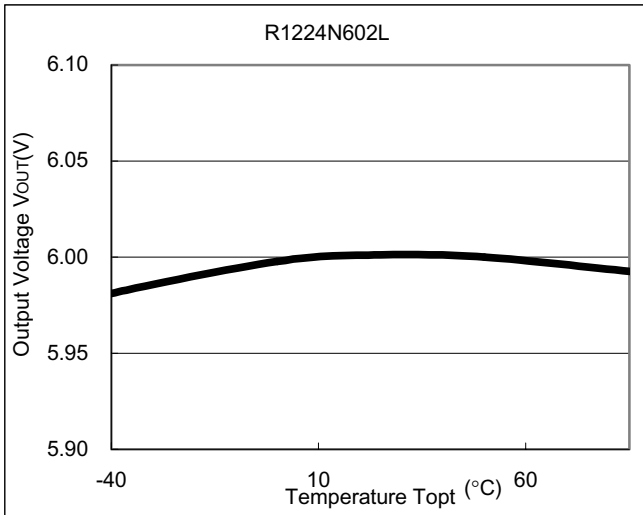

6) Oscillator Frequency vs. Temperature

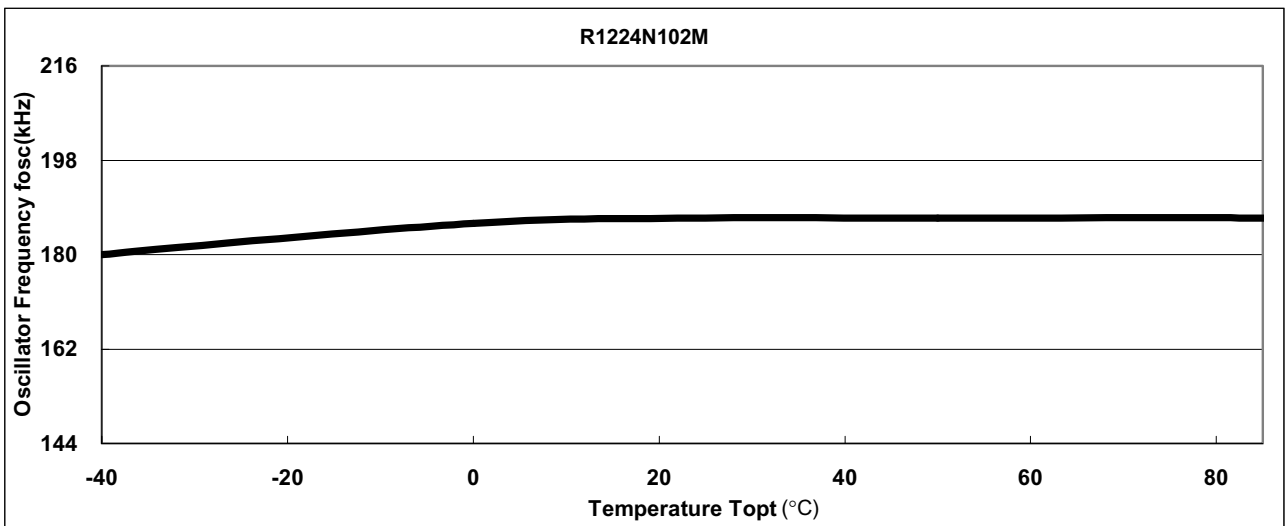
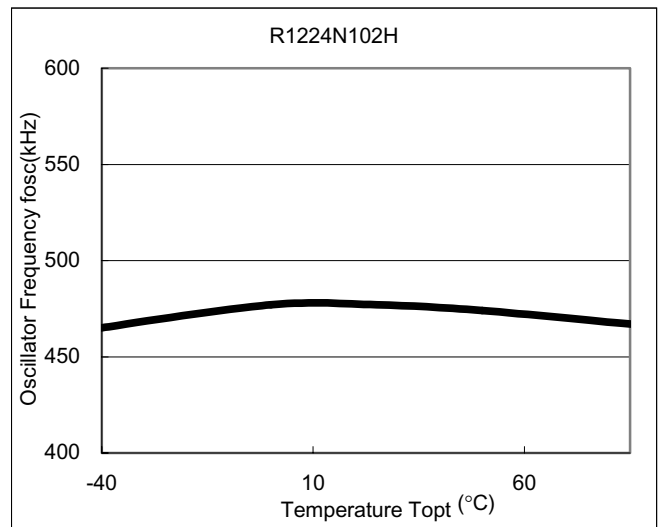
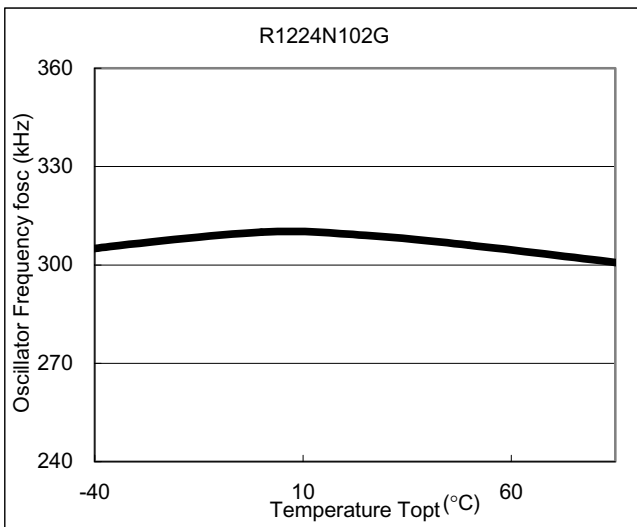

7) Supply Current vs. Temperature

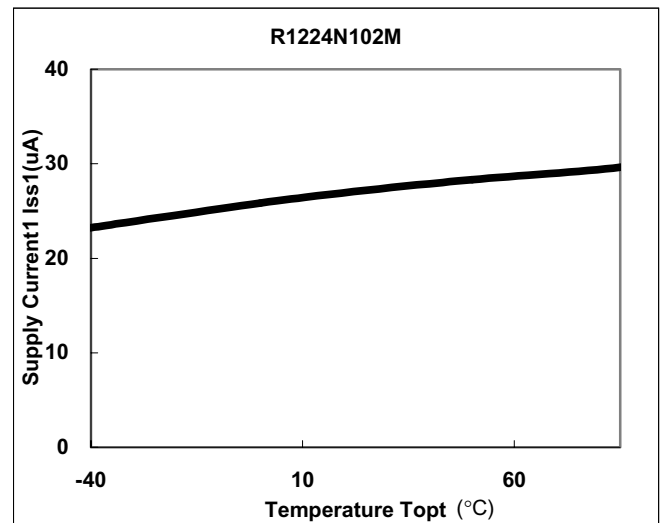
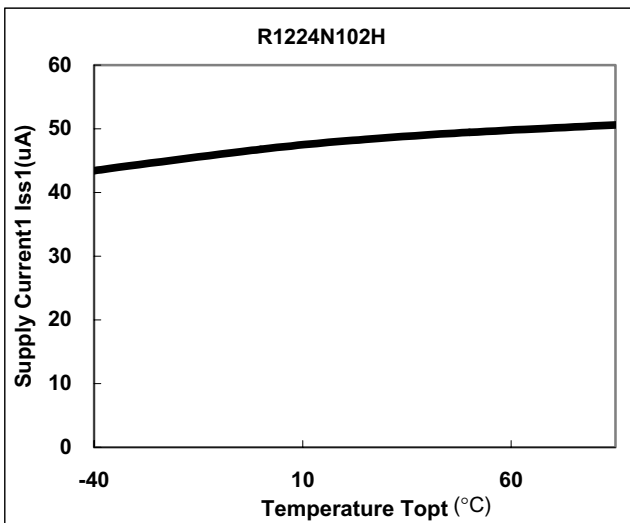
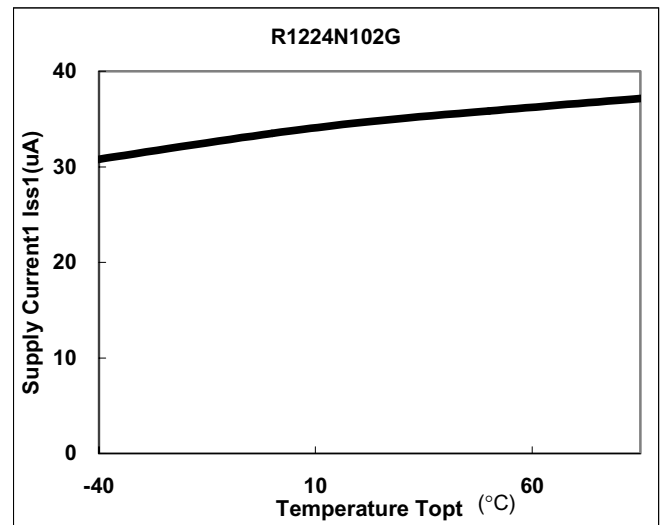
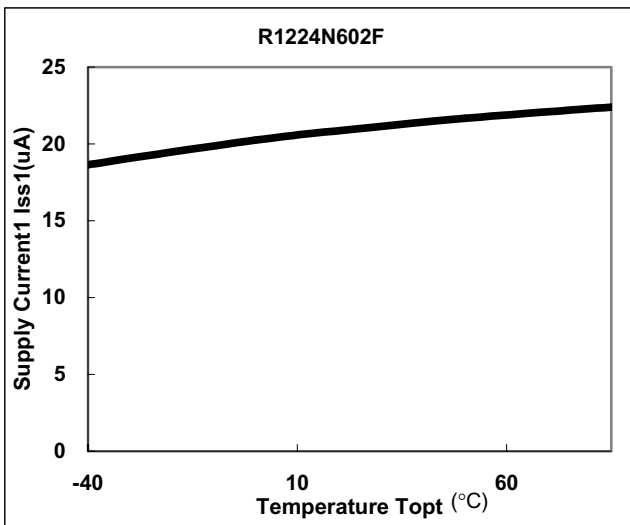
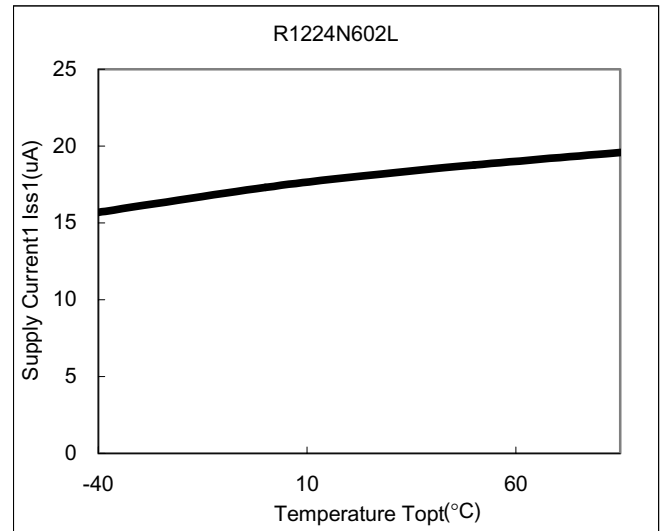
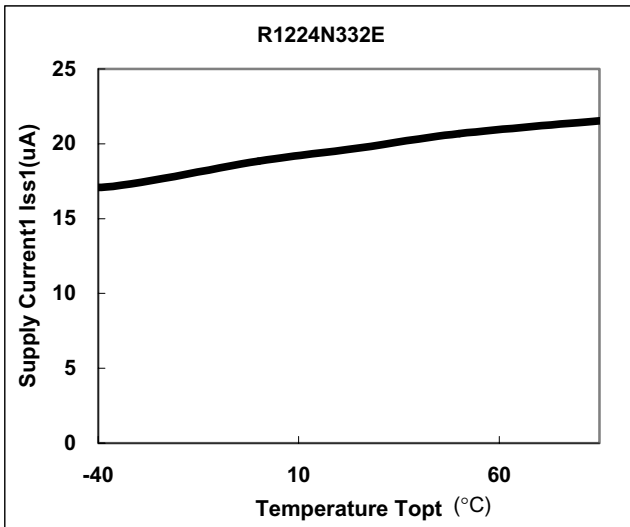

8) Soft-start time vs. Temperature

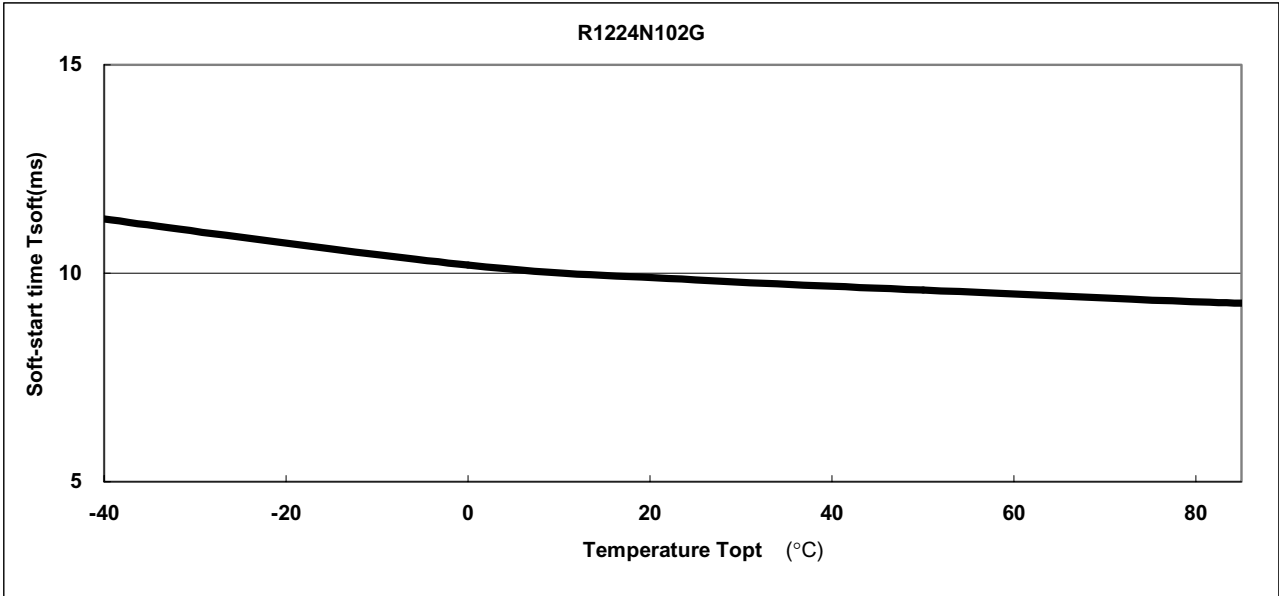

9) Delay Time for Protection vs. Temperature

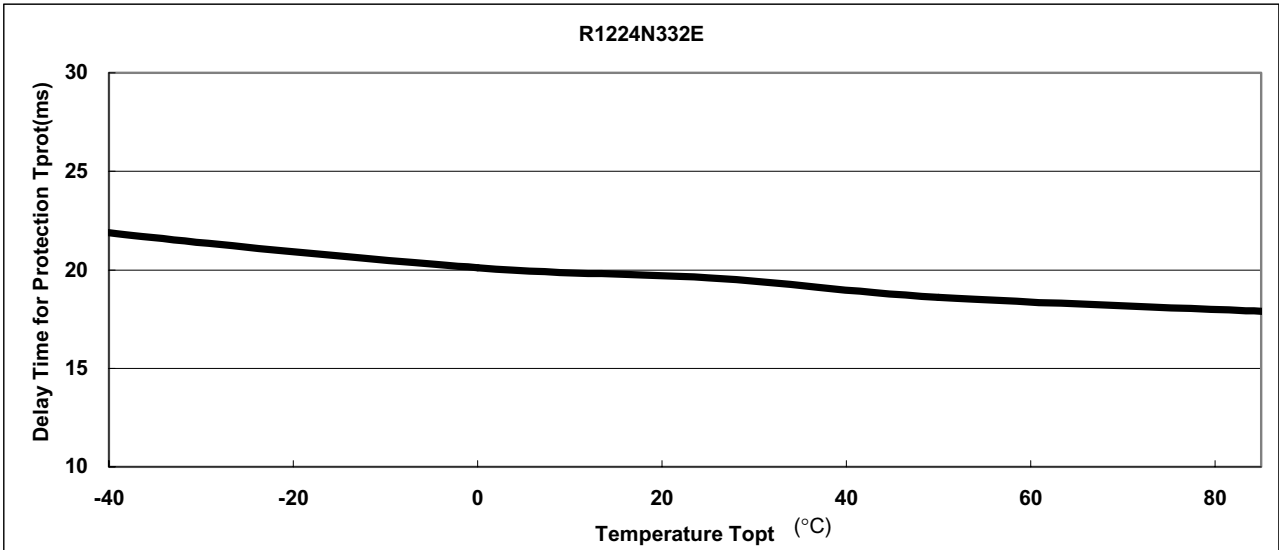

10) EXT "H" Output Current vs. Temperature

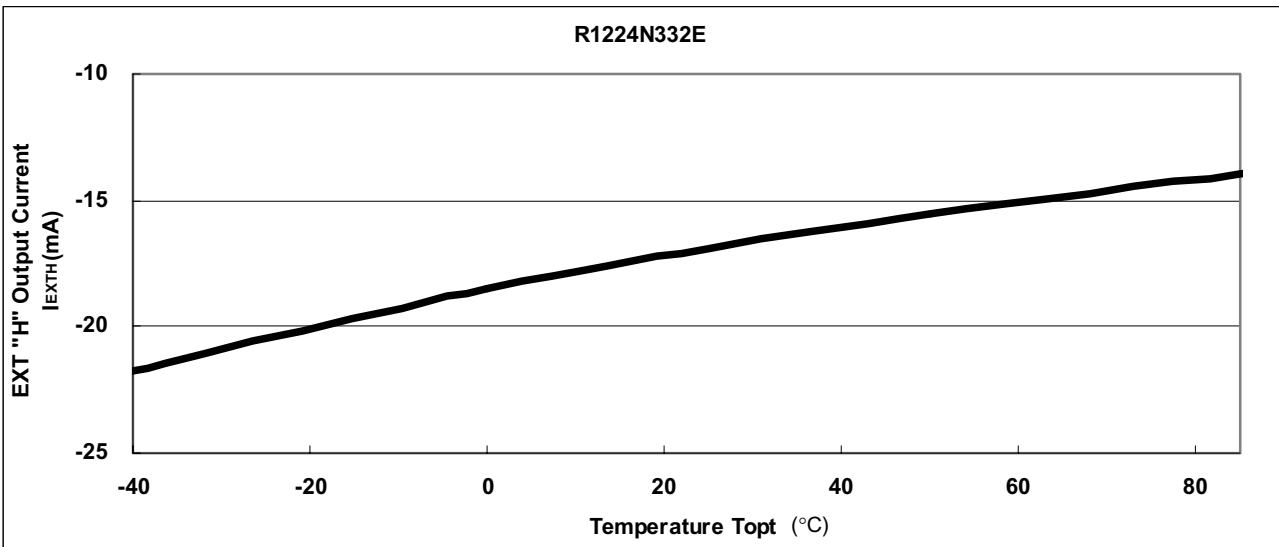

11) EXT"L" Output Current vs. Temperature

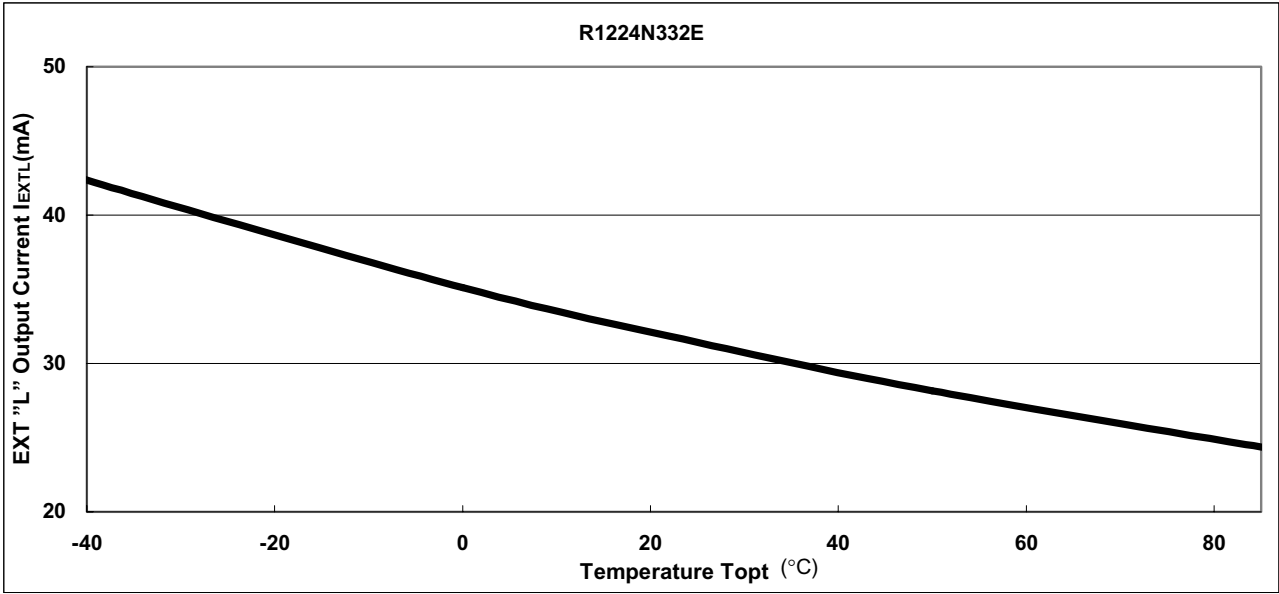

12) Load Transient Response

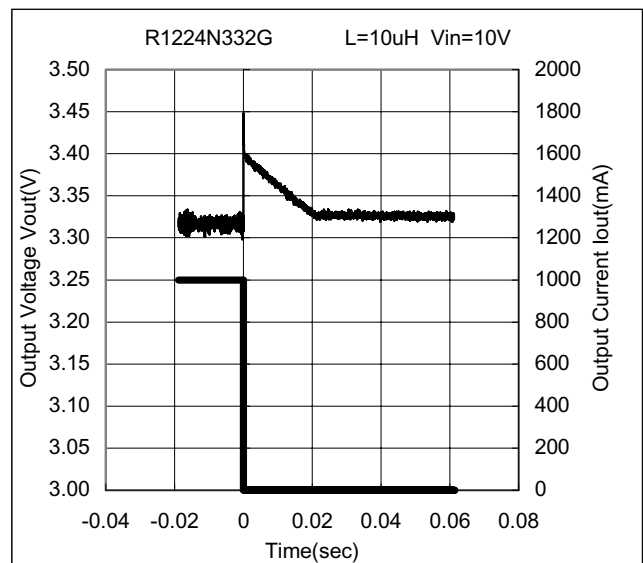
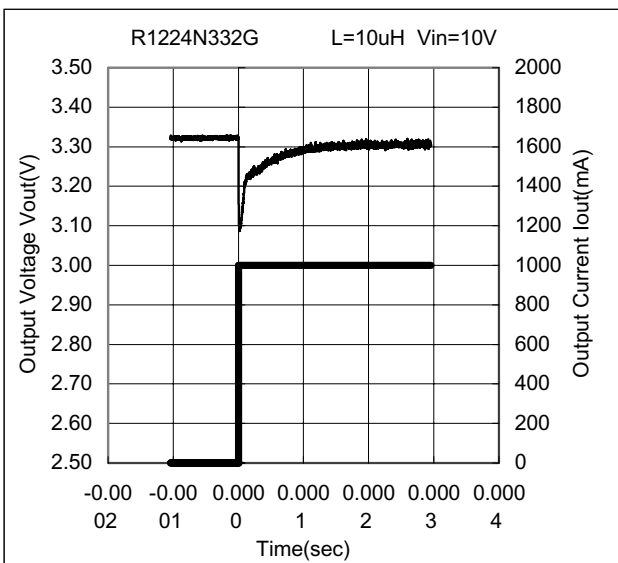
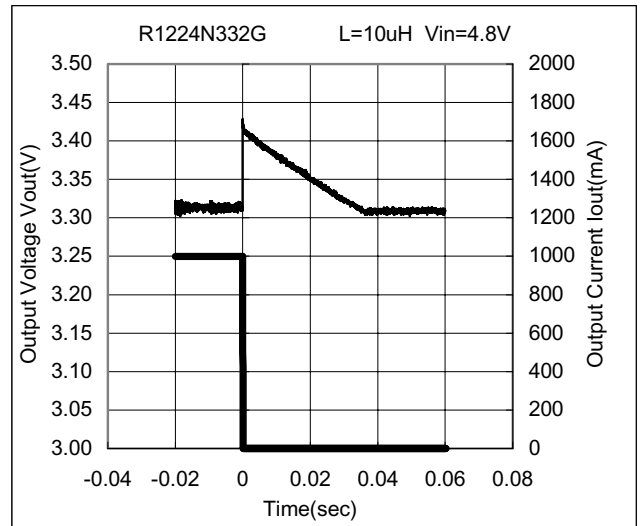
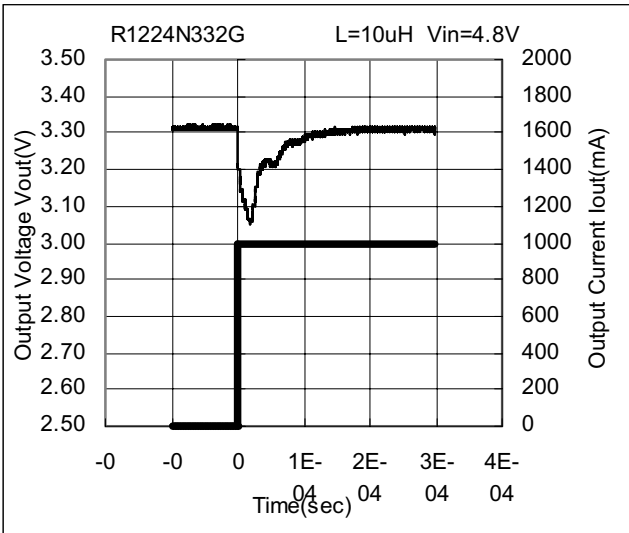

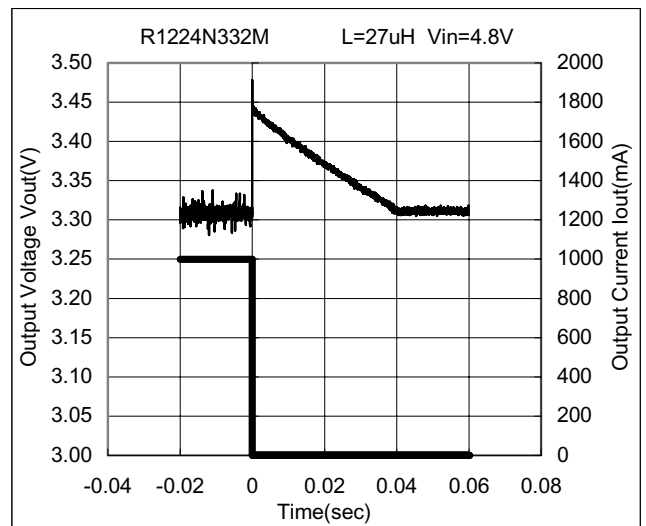
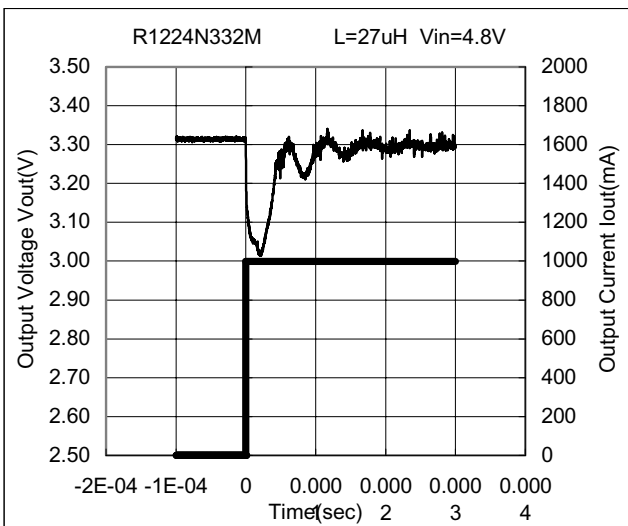
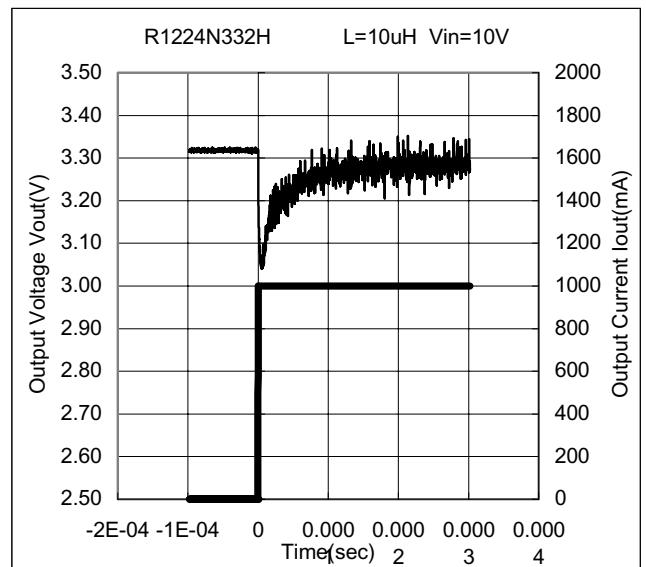
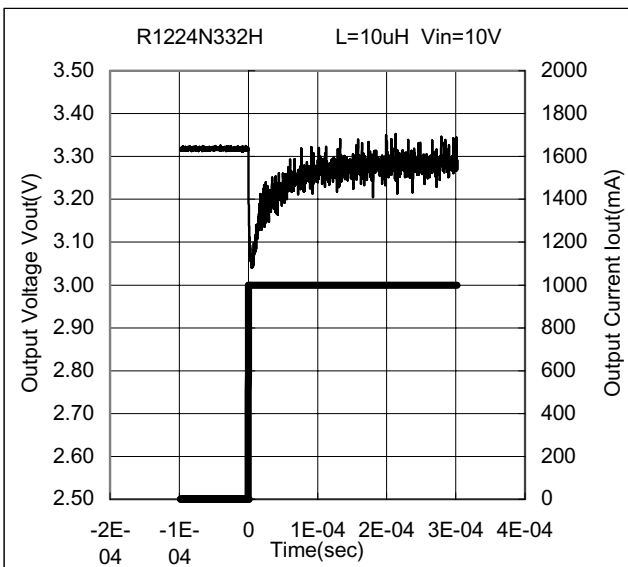
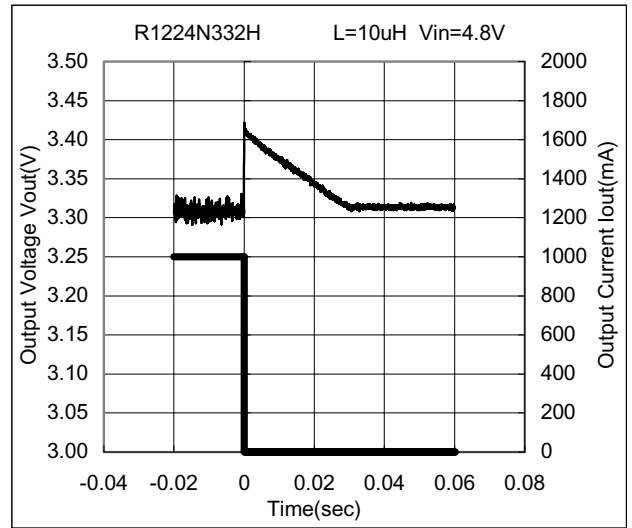
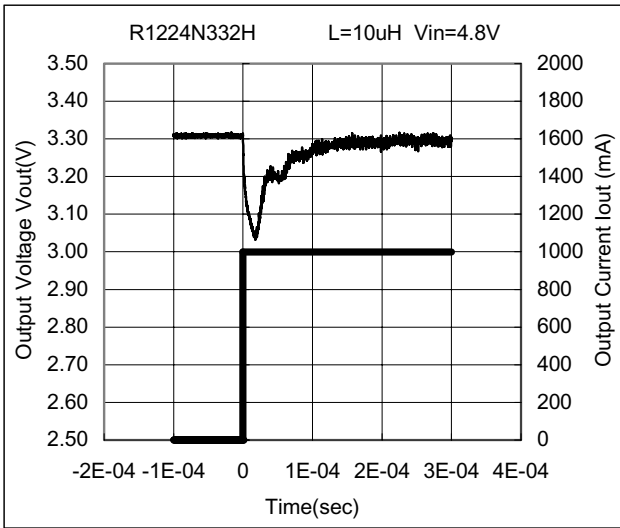

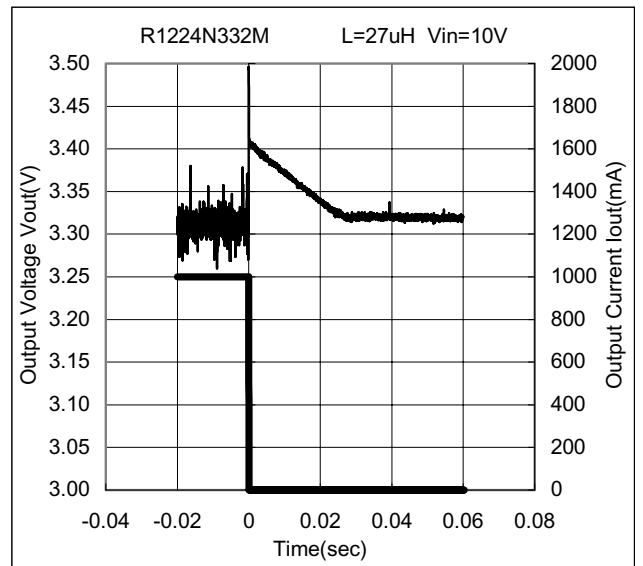
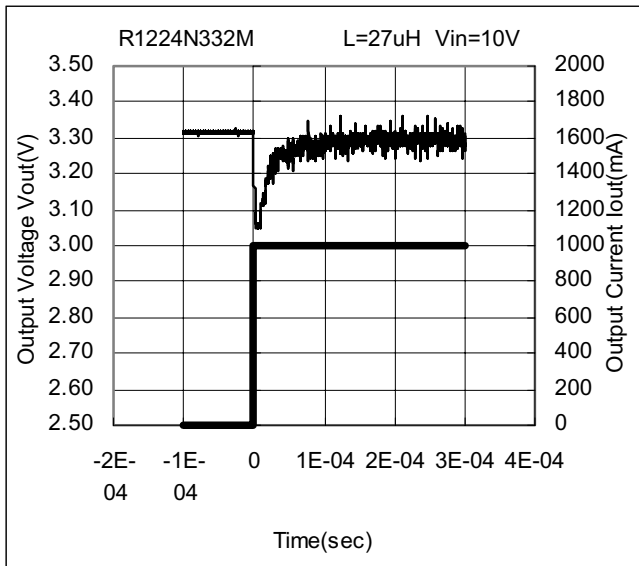

13) UVLO Voltage vs. Temperature

