

**2SB1204,
2SD1804**



2044

PNP/NPN Epitaxial Planar
Silicon Transistors

T-33-19
T-33-09

High-Current Switching Applications

©2006S

Applications

- Relay drivers, high-speed inverters, converters, and other general high-current switching applications

Features

- Low collector-to-emitter saturation voltage
- High current and high f_T
- Excellent linearity of h_{FE}
- Fast switching time
- Small and slim package making it easy to make 2SB1204/2SD1804-applied sets smaller

(): 2SB1204

Absolute Maximum Ratings at $T_a = 25^\circ\text{C}$

Parameter	Symbol	Value	unit
Collector to Base Voltage	V_{CB0}	(-) 60	V
Collector to Emitter Voltage	V_{CE0}	(-) 50	V
Emitter to Base Voltage	V_{EB0}	(-) 6	V
Collector Current	I_C	(-) 8	A
Peak Collector Current	i_{cp}	(-) 12	A
Collector Dissipation	P_C	1	W
		20	W
Junction Temperature	T_j	150	$^\circ\text{C}$
Storage Temperature	T_{stg}	-55 to $+150$	$^\circ\text{C}$

$T_c = 25^\circ\text{C}$

Electrical Characteristics at $T_a = 25^\circ\text{C}$

Parameter	Symbol	Test Conditions	min	typ	max	unit
Collector Cutoff Current	I_{CBO}	$V_{CB} = (-)40\text{V}, I_E = 0$			(-) 1	μA
Emitter Cutoff Current	I_{EBO}	$V_{EB} = (-)4\text{V}, I_C = 0$			(-) 1	μA
DC Current Gain	$h_{FE(1)}$	$V_{CE} = (-)2\text{V}, I_C = (-)0.5\text{A}$	70^*		400^*	
	$h_{FE(2)}$	$V_{CE} = (-)2\text{V}, I_C = (-)6\text{A}$	35			
Gain-Bandwidth Product	f_T	$V_{CE} = (-)5\text{V}, I_C = (-)1\text{A}$		180		MHz
				(130)		
Output Capacitance	c_{ob}	$V_{CB} = (-)10\text{V}, f = 1\text{MHz}$			(95) 65	pF



Continued on next page.

* : The 2SB1204/2SD1804 are classified by 0.5A h_{FE} as follows :

70	Q	140	100	R	200	140	S	280	200	T	400
----	---	-----	-----	---	-----	-----	---	-----	-----	---	-----

Case Outline 2044
(unit : mm)

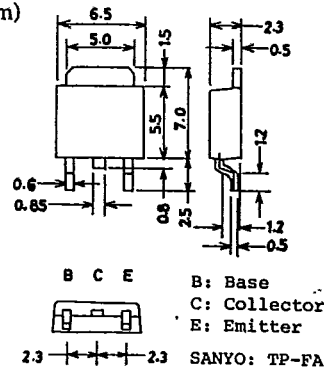

2SB1204/2SD1804

T-33-19
T-33-09

Continued from preceding page.

			min	typ	max	unit
C-E Saturation Voltage	$V_{CE(sat)}$	$I_C = (-)4A, I_B = (-)0.2A$		200	400	mV
B-E Saturation Voltage	$V_{BE(sat)}$	$I_C = (-)4A, I_B = (-)0.2A$		(-250)	(-500)	V
C-B Breakdown Voltage	$V_{(BR)CBO}$	$I_C = (-)10\mu A, I_E = 0$	(-)	60		V
C-E Breakdown Voltage	$V_{(BR)CEO}$	$I_C = (-)1mA, R_{BE} = \infty$	(-)	50		V
E-B Breakdown Voltage	$V_{(BR)EBO}$	$I_E = (-)10\mu A, I_C = 0$	(-)	6		V
Turn-on Time	t_{on}	See specified Test Circuit.		(50)		ns
Storage Time	t_{stg}	"		(450)500		ns
Fall Time	t_f	"		20		ns

Switching Time Test Circuit

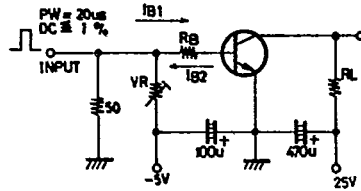

$I_C = 10A, I_{B1} = -10A, I_{B2} = 4A$
(For PNP, the polarity is reversed.)

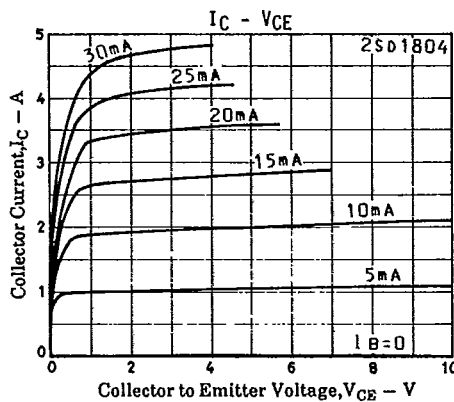
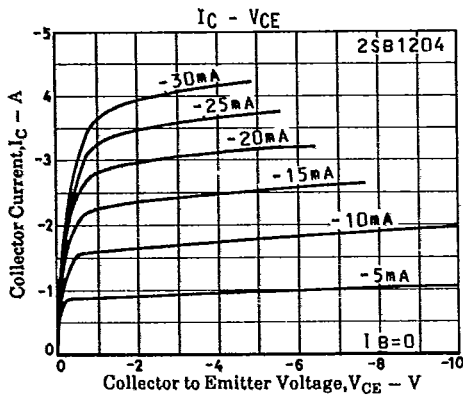
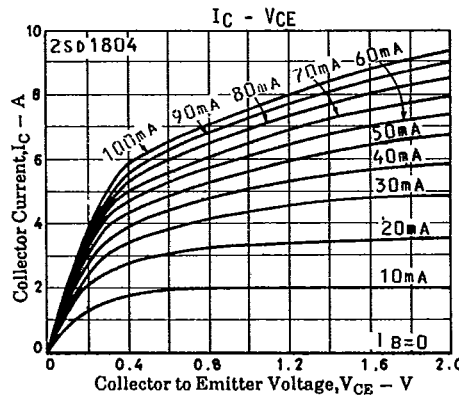
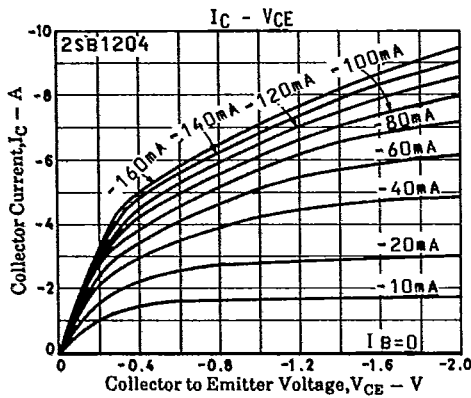

2SB1204/2SD1804

T-33-19
T-33-09

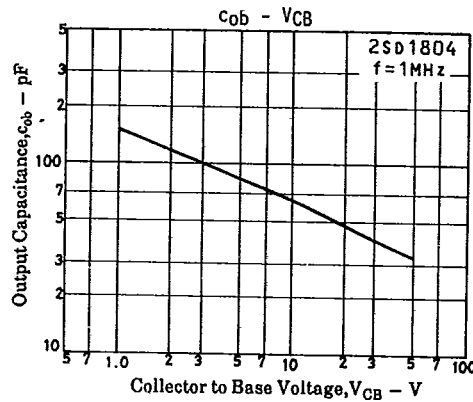
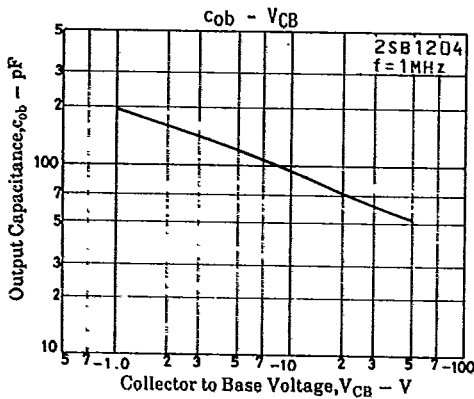
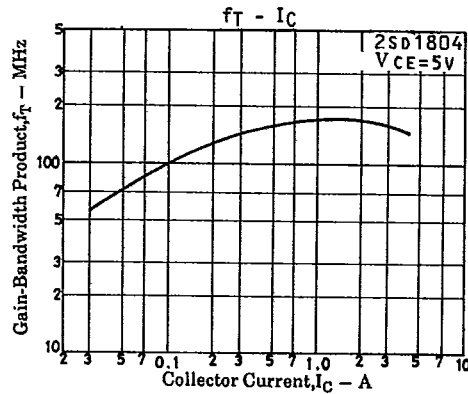
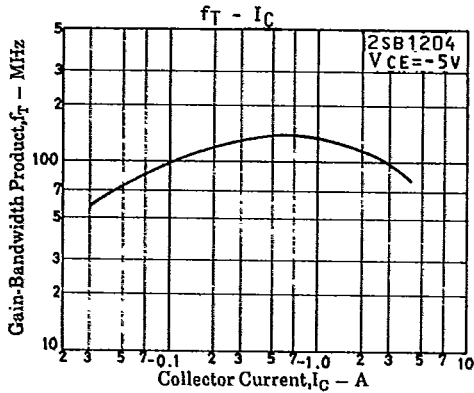
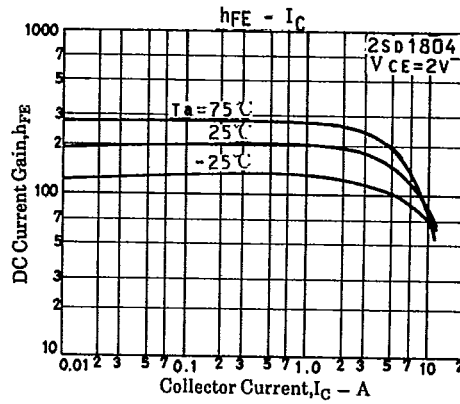
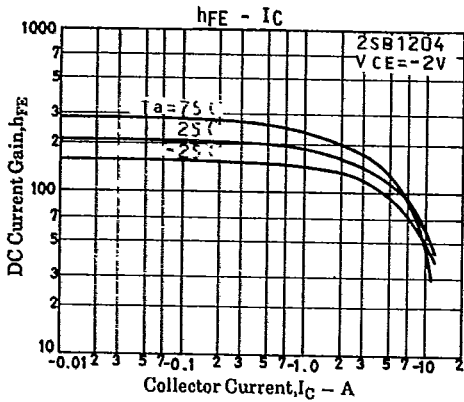
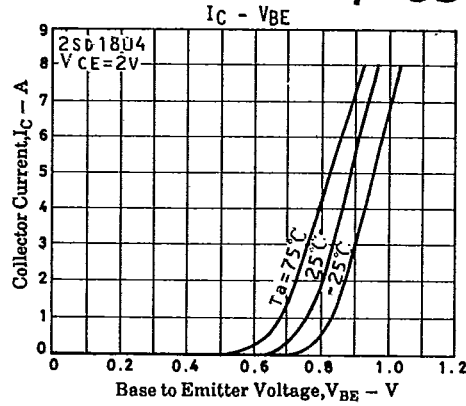
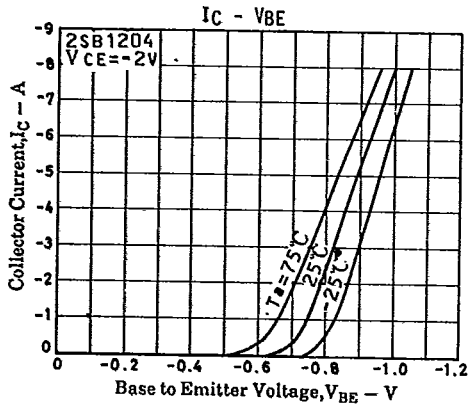

T-91-20

CASE OUTLINES OF SURFACE MOUNT TRANSISTORS

- All of Sanyo surface mount transistor case outlines are illustrated below.
- All dimensions are in mm, and dimensions which are not followed by min. or max. are represented by typical values.
- No marking is indicated.

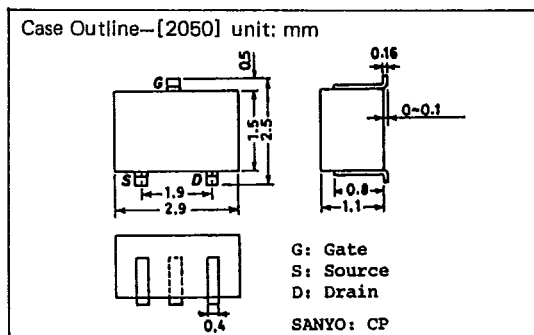
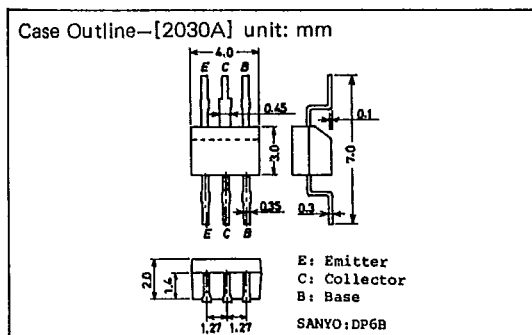
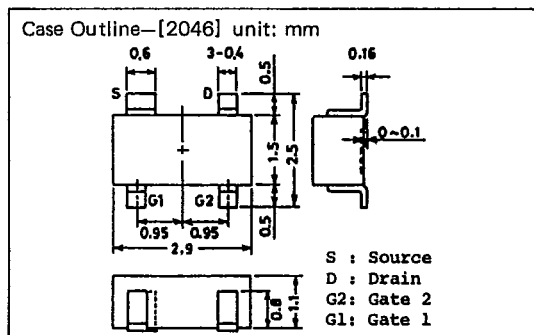
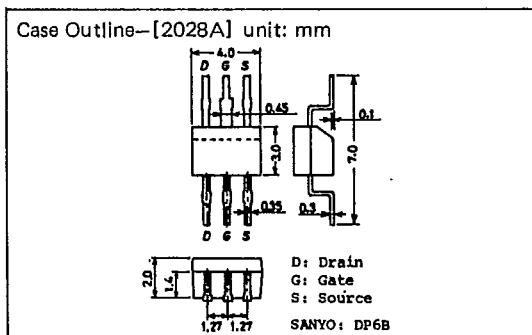
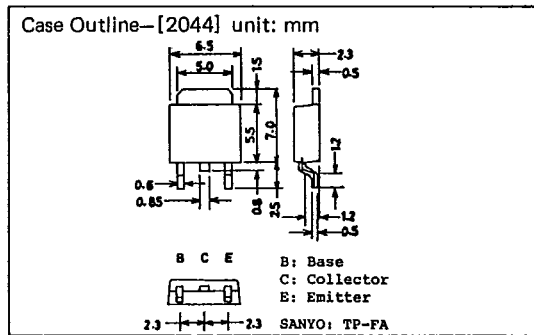
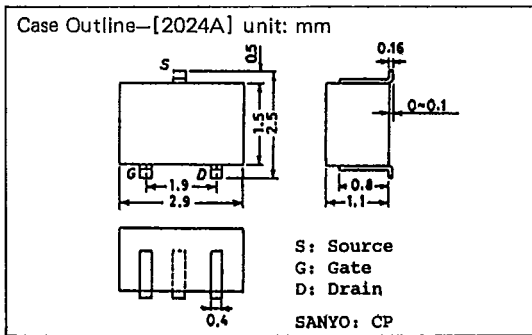
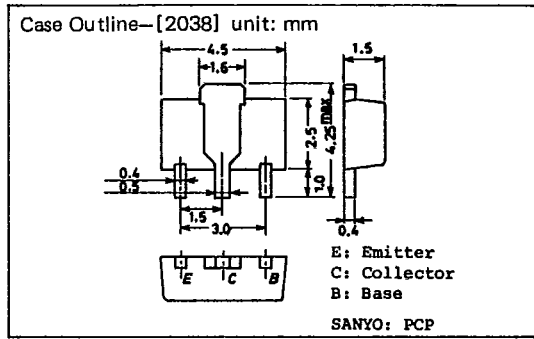
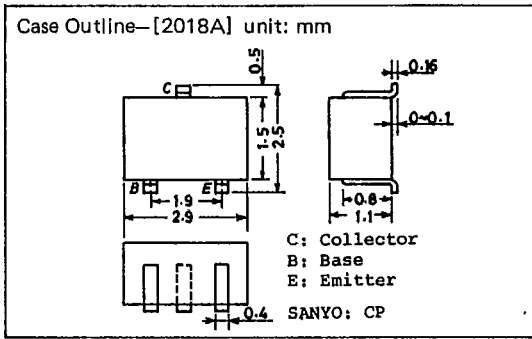

T-91-20

Case Outline—[2057] unit: mm

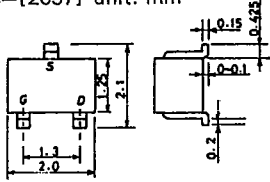

S: Source
G: Gate
D: Drain
SANYO: MCP

Case Outline—[2066] unit: mm

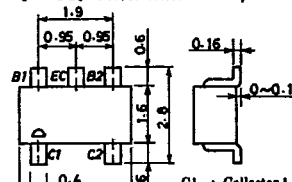

C1 : Collector 1
C2 : Collector 2
B2 : Base 2
EC : Emitter Common
B1 : Base 1
SANYO : CP6

Case Outline—[2058] unit: mm

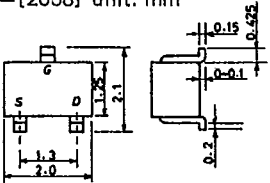

G: Gate
S: Source
D: Drain
SANYO: MCP

Case Outline—[2067] unit: mm

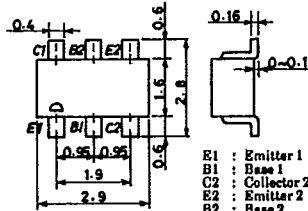

E1 : Emitter 1
B1 : Base 1
C2 : Collector 2
E2 : Emitter 2
B2 : Base 2
C1 : Collector 1
SANYO : CP6

Case Outline—[2059] unit: mm

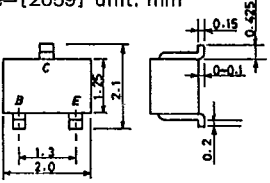

B: Base
C: Collector
E: Emitter
SANYO: MCP

Case Outline—[2068] unit: mm

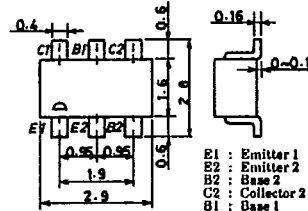

B1 : Emitter 1
E2 : Emitter 2
B2 : Base 2
C2 : Collector 2
B1 : Base 1
C1 : Collector 1
SANYO : CP6

Case Outline—[2062] unit: mm

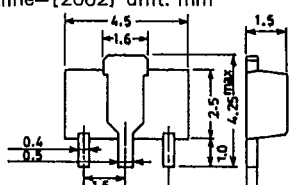

S: Source
D: Drain
G: Gate
SANYO: PCP

Case Outline—[2069] unit: mm

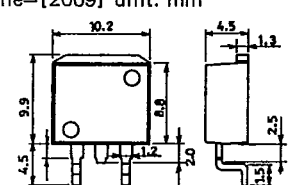

B: Base
C: Collector
E: Emitter
SANYO: SMP

Case Outline—[2065] unit: mm

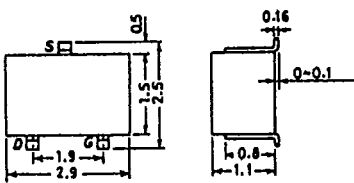

S: Source
D: Drain
G: Gate
SANYO: CP

Case Outline—[2070] unit: mm

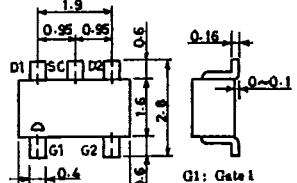

G1 : Gate 1
G2 : Gate 2
D2 : Drain 2
SC : Source Common
D1 : Drain 1
SANYO : CP6

T-9120

