

T-29-11

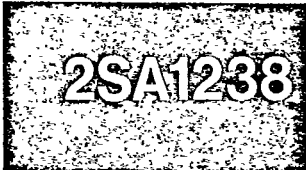

2029A

PNP Epitaxial Planar Silicon Transistor

Differential Amp Applications

©968C

Applications

- . Differential amp, current mirror.

Features

- . Excellent in thermal equilibrium and suited for use in first-stage differential amp.
- . Low noise.
- . Matched pair capability.

Absolute Maximum Ratings at Ta=25°C

Parameter	Symbol	Value	Unit
Collector to Base Voltage	V_{CBO}	-55	V
Collector to Emitter Voltage	V_{CEO}	-50	V
Emitter to Base Voltage	V_{EBO}	-5	V
Collector Current	I_C	-150	mA
Peak Collector Current	i_{cp}	-300	mA
Collector Dissipation	P_C	200	mW
Total Dissipation	P_T	400	mW
Junction Temperature	T_j	150	°C
Storage Temperature	T_{stg}	-55 to +150	°C

1 unit

Electrical Characteristics at Ta=25°C

Parameter	Symbol	Test Conditions	min	typ	max	Unit
Collector Cutoff Current	I_{CBO}	$V_{CB} = -35V, I_E = 0$			-0.1	uA
Emitter Cutoff Current	I_{EBO}	$V_{EB} = -4V, I_C = 0$			-0.1	uA
DC Current Gain	h_{FE}	$V_{CE} = -6V, I_C = -1mA$	100*		560*	
DC Current Gain Ratio	$h_{FE(small/large)}$	$V_{CE} = -6V, I_C = -1mA$	0.85	0.98		

Continued on next page.

*: The 2SA1238 is classified by $h_{FE(small)}$ as follows:

100 E	200	160 F	320	280 G	560
-------	-----	-------	-----	-------	-----

The 2SA1238 is provided with a surface mounted package.

Case Outline 2029A
(unit:mm)

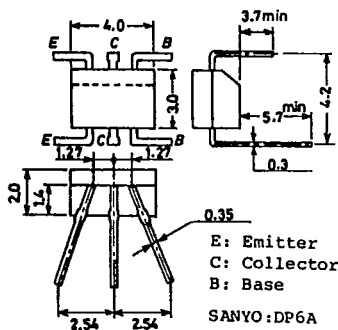

Case Outline 2030A
(unit:mm)

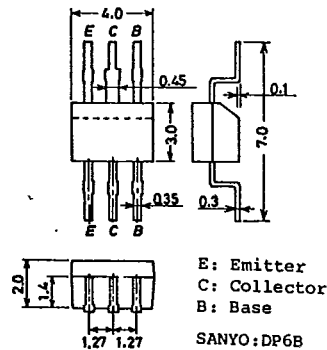

Continued from preceding page.

			min	typ	max	unit
Base to Emitter Voltage Drop	$V_{BE(large-small)}$	$V_{CE}=-6V, I_C=-1mA$		1.0	10	mV
Collector to Emitter Saturation Voltage	$V_{CE(sat)}$	$I_C=-50mA, I_B=-5mA$			-0.5	V
Gain-Bandwidth Product	f_T	$V_{CE}=-6V, I_C=-1mA$		100		MHz
Output Capacitance	c_{ob}	$V_{CB}=-10V, f=1MHz$		5.0		pF
Collector to Base Breakdown Voltage	$V_{(BR)CBO}$	$I_C=-10uA, I_E=0$	-55			V
Collector to Emitter Breakdown Voltage	$V_{(BR)CEO}$	$I_C=-1mA, R_{BE}=\infty$	-50			V
Emitter to Base Breakdown Voltage	$V_{(BR)EBO}$	$I_B=-10uA, I_C=0$	-5			V
Noise Level	$V_{NO(ave)}$	$V_{CC}=30V, I_C=1mA, R_g=56k\Omega, V_G=77dB/1kHz$			35	mV
Noise Peak Level	$V_{NO(peak)}$	$V_{CC}=30V, I_C=1mA, R_g=56k\Omega, V_G=77dB/1kHz$			200	mV

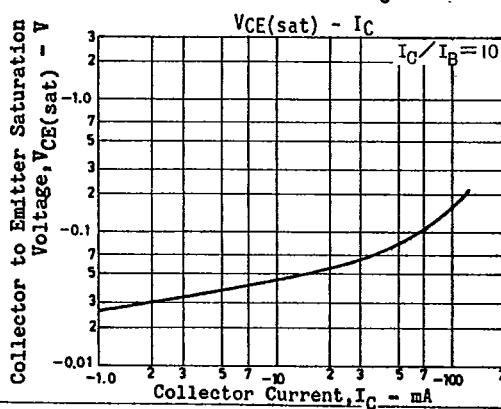
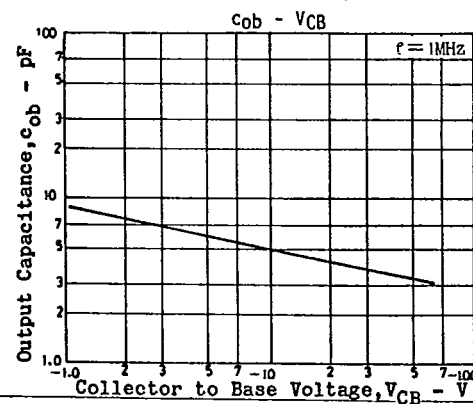
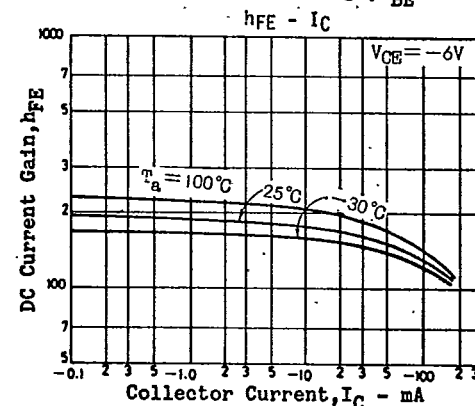
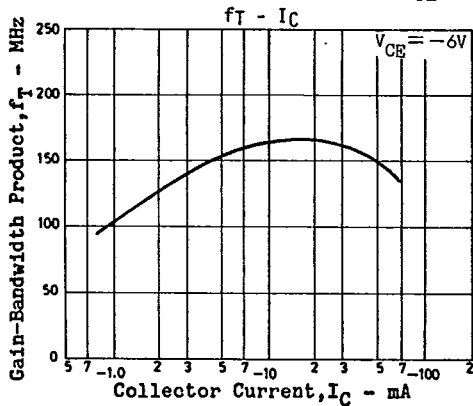
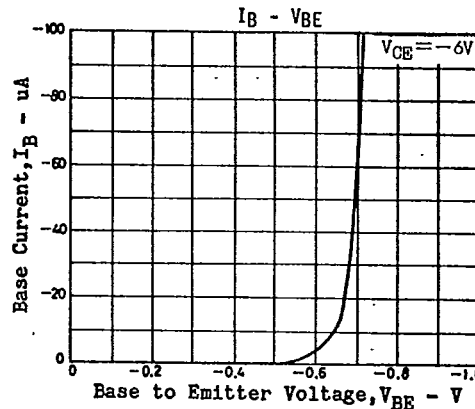
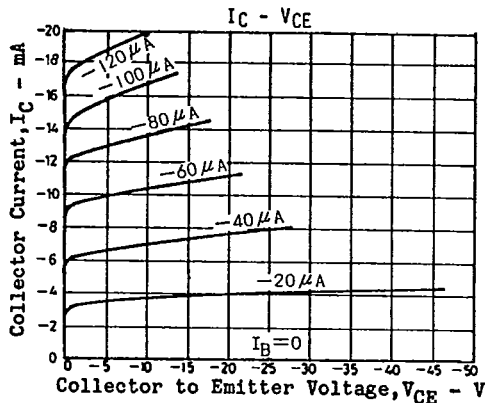

2SA1238

T-29-11

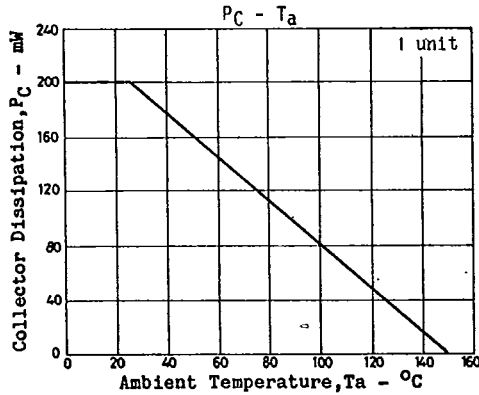
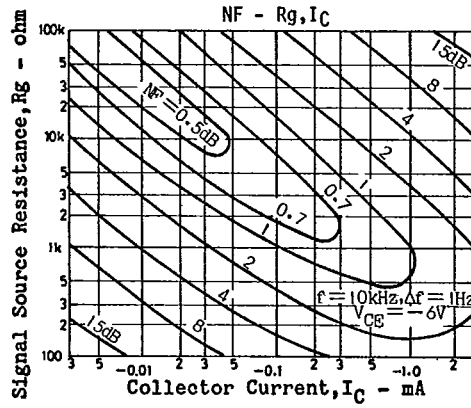
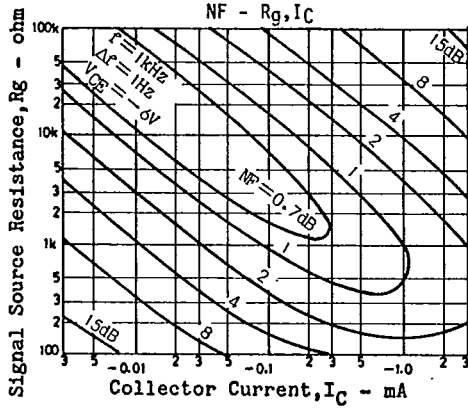
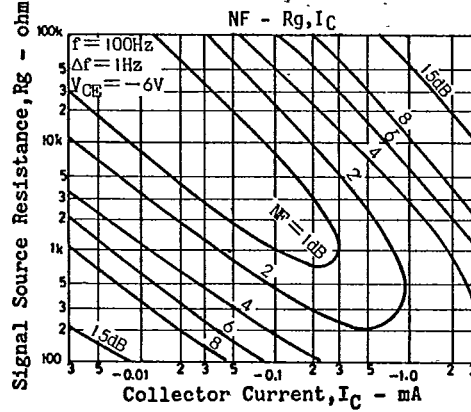
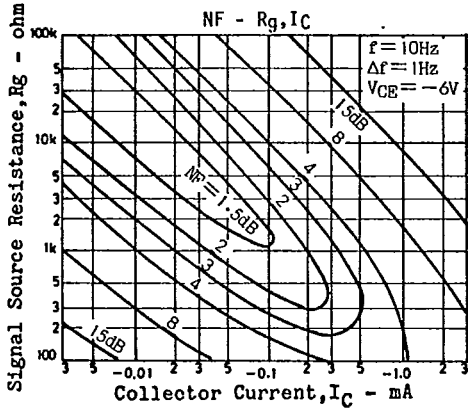

T-91-20

CASE OUTLINES OF LEAD FORMED SMALL SIGNAL TRANSISTORS

- All of Sanyo lead formed small signal transistor case outlines are illustrated below.
- All dimensions are in mm, and dimensions which are not followed by min. or max. are represented by typical values.
- No marking is indicated.

Case Outline-[2003A] unit: mm

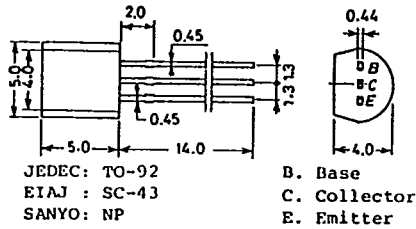

Case Outline-[2019A] unit: mm

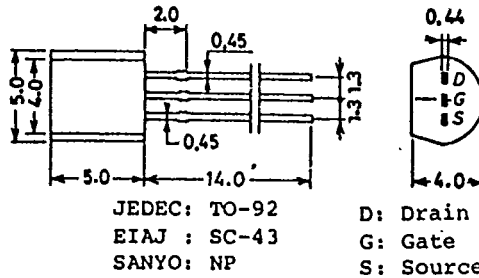

Case Outline-[2004A] unit: mm

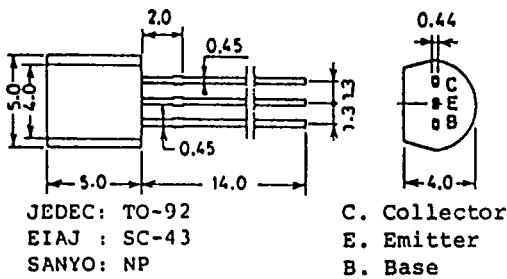

Case Outline-[2025] unit: mm

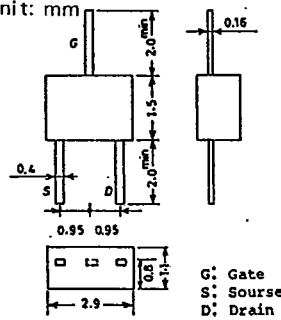

Case Outline-[2005A] unit: mm

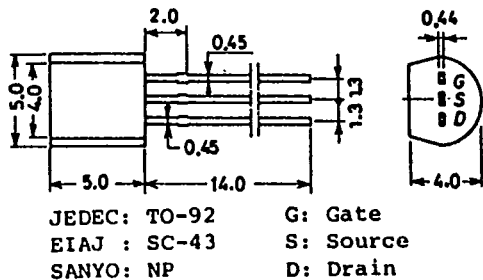

Case Outline-[2026] unit: mm

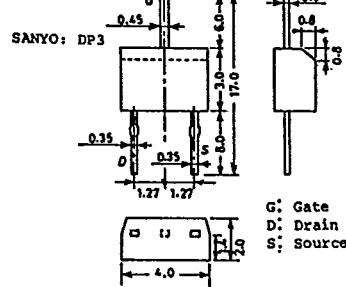

Case Outline-[2006A] unit: mm

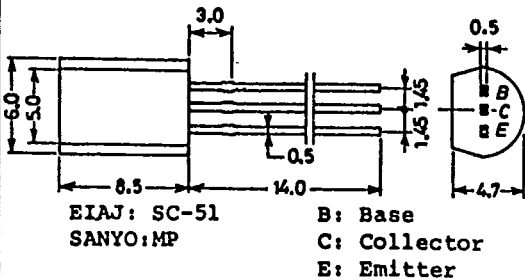

Case Outline-[2027A] unit: mm

