

PROFET®

- High-side switch
- Short-circuit protection
- Overtemperature protection
- Overload protection
- Load dump protection¹⁾
- Undervoltage and overvoltage shutdown with auto-restart and hysteresis
- Reverse battery protection¹⁾
- Input and status protection
- Clamp of negative output voltage with inductive loads
- Protection against charged inductive load disconnect²⁾
- Open load detection in ON-state
- Maximum current internally limited
- Status output for load fault
- R_{ON} constant versus V_{bb}
- Electrostatic Discharge (ESD) protection

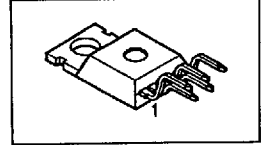

Version differences see truth table and options overview, page 46...47

Package: TO220AB/5 (mounting flange is shorted to pin 3),
different package outlines (see page 54) on request

Ordering codes and packages see page 54

Pins				
1	2	3	4	5
GND	IN	V_{bb}	ST	OUT
-		+	S	O (Load, L)

Maximum Ratings

Parameter	Symbol	Values	Unit	
Active overvoltage protection	$V_{bb(AZ)}$	> 50	V	
Load current (Short-circuit current, see page 45)	I_L	self-limited	A	
Operating temperature range	T_J	-40 ... +150	°C	
Storage temperature range	T_{stg}	-55 ... +150		
Max. power dissipation	P_{tot}	75	W	
Maximum current through input pin (DC)	I_{IN}	±2.0	mA	
Maximum current through status pin (DC)	I_{ST}	±5.0		
see internal circuit diagram see chapter 2				
Thermal resistance	chip - case chip - ambient:	R_{thJC} R_{thJA}	1.67 75	K/W

- 1) with resistor $R_{GND}=150\ \Omega$ in GND connection, 15 k Ω resistor in series with IN and ST connections, reverse load current limited by connected load.
- 2) with 150 Ω resistor in GND connection or freewheeling diode between V_{bb} and GND or freewheeling diode parallel to load. To protect against V_{bb} loss with an inductive load, it is recommended that a freewheeling diode be added between V_{bb} and GND.



Electrical Characteristics

Parameter and Conditions at $T_j = 25^\circ\text{C}$, $V_{bb} = 12\text{V}$ unless otherwise specified	Symbol	Values			Unit
		min	typ	max	

Load Switching Capabilities and Characteristics

On-state resistance (pin 3 to 5) $I_L = 1\text{ A}$, $V_{IN} = \text{high}$	$T_j = 25^\circ\text{C}$: $T_j = 150^\circ\text{C}$:	R_{ON}	--	190 390	220 440	m Ω
Nominal load current (pin 3 to 5) ISO Proposal: $V_{bb} - V_{OUT} \leq 0.5\text{ V}$, $T_C = 85^\circ\text{C}$		$I_{L(ISO)}$	1.6	--	--	A
Open load detection current	$T_j = 25..150^\circ\text{C}$: $T_j = -40^\circ\text{C}$:	$I_{L(OL)}$	2 2	-- --	150 200	mA
Turn-on time to 90% V_{OUT}		t_{on}	15	--	60	μs
Turn-off time to 10% V_{OUT}		t_{off}	5	--	50	
Slew rate on 10 to 30% V_{OUT} , $R_L = 12\ \Omega$		dV/dt_{on}	--	--	3	V/ μs
Slew rate off 70 to 40% V_{OUT} , $R_L = 12\ \Omega$		$-dV/dt_{off}$	--	--	5	
Standby current (pin 3) $V_{IN} = 0$	$T_j = 150^\circ\text{C}$:	$I_{bb(off)}$	--	12 18	25 60	μA
Operating current (Pin 1), $V_{IN} = \text{high}$		I_{GND}	--	2.2 ³⁾	--	mA
Short circuit shutdown delay after input pos. slope $T_j = -40..+150^\circ\text{C}$: $V_{bb} - V_{OUT} = V_{ON} > V_{ON(SC)}$ (see page 45) min value valid only, if input "low" time exceeds 60 μs		$t_{d(SC)}$	80	--	350	μs

Input and Status Feedback⁴⁾

Allowable input voltage range, (pin 2 to 1)		V_{IN}	-0.5	--	5.5	V
Input turn-on threshold voltage 		$V_{IN(T+)}$	1.5	--	2.4	V
Input turn-off threshold voltage 		$V_{IN(T-)}$	0.8	--	--	V
Input threshold hysteresis		$\Delta V_{IN(T)}$	--	0.5	--	V
Off state input current (pin 2) $V_{IN(off)} = 0.4\text{ V}$		$I_{IN(off)}$	1	--	30	μA
On state input current (pin 2) $V_{IN(on)} = 3.5\text{ V}$		$I_{IN(on)}$	10	25	70	
Delay time for status with open load (see timing diagrams, page 53)		$t_{d(ST OL1)}$ $t_{d(ST OL2)}$	--	700 200	--	μs
Status valid after input slope (short circuit, open load)	$T_j = -40 \dots +150^\circ\text{C}$:	$t_{d(ST)}$	80	--	350	μs

³⁾ see diagram page 51, Add I_{ST} , if $I_{ST} > 0$

⁴⁾ if a ground resistor R_{GND} is used, add the voltage across this resistor. Internal Z-diode typ. 6.1 V, see maximum ratings page 43, (see chapter 3)

Parameter and Conditions at $T_j = 25^\circ\text{C}$, $V_{bb} = 12\text{V}$ unless otherwise specified	Symbol	Values			Unit
		min	typ	max	
Status output (open drain)					
zener limit voltage, $T_j = +25^\circ\text{C}$:	$V_{ST(\text{high})}$	5.5	6.1	6.6	V
$T_j = -40\dots+150^\circ\text{C}$:		5.4	--	6.9	
$T_j = -40\dots+25^\circ\text{C}$, $I_{ST} = +1.6\text{mA}$:	$V_{ST(\text{low})}$	--	--	0.8	
$T_j = +150^\circ\text{C}$, $I_{ST} = +1.6\text{mA}$:		--	--	1.0	
	I_{ST}	--	--	1.6	mA

Operating and Clamp Voltages

Operating voltage	$T_j = 25^\circ\text{C}$: $T_j = -40\dots+150^\circ\text{C}$:	$V_{bb(\text{on})}$	4.9 5.8	--	42 40	V
Undervoltage shutdown	$T_j = 25\dots+150^\circ\text{C}$: $T_j = -40^\circ\text{C}$:	$V_{bb(\text{under})}$	2.4 3.0	--	4.9 5.4	
Undervoltage restart	$T_j = 25\dots+150^\circ\text{C}$: $T_j = -40^\circ\text{C}$:	$V_{bb(\text{u rst})}$	-- --	--	4.9 5.8	
Overvoltage shutdown	$T_j = -40\dots+150^\circ\text{C}$:	$V_{bb(\text{over})}$	42	--	52	
Overvoltage restart	$T_j = -40\dots+150^\circ\text{C}$:	$V_{bb(\text{o rst})}$	40	--	--	
Overvoltage protection	$T_j = -40\dots+150^\circ\text{C}$:	$V_{bb(\text{AZ})}$	50	56	--	
Load dump protection ⁵⁾		$V_{bb(\text{LD})}$	--	--	93.5	
Output clamp (inductive load switch off)		$-V_{\text{OUT}(\text{CL})}$	--	10	--	
Short circuit shutdown detection voltage (pin 3 to 5)		$V_{\text{ON}(\text{SC})}$	--	8.6	10	

Protection Functions

Overload current limit (pin 3 to 5), after 200 ms, $V_{\text{ON}} = 8\text{V}$, no heatsink ⁶⁾ , , see diagram page 49 $T_j = -40\dots+150^\circ\text{C}$	$I_L(\text{lim})$	2.0	6	11	A
Thermal overload trip temperature	T_{jt}	150	--	--	$^\circ\text{C}$
Inductive load switch-off energy dissipation ⁷⁾ , $T_{j \text{ start}} = 150^\circ\text{C}$, $V_{bb} = 12\text{V}$ $V_{bb} = 12\text{V}$: $E_{\text{Load}} = 1/2 * L * I_L^2$ $V_{bb} = 24\text{V}$: $E_{\text{Load}24}$	E_{ab} $E_{\text{Load}12}$ $E_{\text{Load}24}$	-- -- --	-- -- --	1.4 0.6 0.4	J
Reverse battery (pin 1 to 3) ⁸⁾	$-V_{bb}$	--	--	32	V

5) Requires 150 Ω resistor in GND connection. Input and Status currents have to be limited. It is recommended that 15kΩ resistors be inserted in series with IN and ST.

6) this occurs, if circuit resistance is so high, that no short circuit shutdown occurs ($V_{\text{ON}} < V_{\text{ON}(\text{SC})}$)

7) while demagnetizing load inductance, dissipated energy in PROFET is $E_{ab} = \int (V_{bb} + |V_{\text{OUT}(\text{CL})}|) * i_L(t) dt$,
approx. $E_{ab} = 1/2 * L * I_L^2 * (1 + \frac{V_{bb}}{|V_{\text{OUT}(\text{CL})}|})$

8) Requires 150 Ω resistor in GND connection. Reverse load current (through intrinsic drain-source diode) is normally limited by the connected load. Reverse current I_{GND} of about 0.4 A at $V_{bb} = -32\text{V}$ through the logic (see chapter 3) heats up the device. Time allowed under these condition is dependent on the size of the heatsink. Input and Status currents have to be limited. It is recommended that 15kΩ resistors be inserted in series with IN and ST.

Truth Table

	Input-level	Output level	Status				
			version 412 B	version D	version E/F	version G	version H
Normal operation	L	L	H	H	H	H	H
	H	H	H	H	H	H	H
Open load	L	⁹⁾	L	H	H	H	L
	H	H	H	L	L	L	H
Short circuit to GND	L	L	H	H	H	H	H
	H	L	L	L	L	H	L
Short circuit to V_{bb}	L	H	L	H	H	H	L
	H	H	H	H (L ¹⁰)	H (L ¹⁰)	H (L ¹⁰)	H
Overtemperature	L	L	L	L	L	L	L
	H	L	L	L	L	L	L
Undervoltage	L	L	L ¹¹⁾	L ¹¹⁾	H	H	H
	H	L	L ¹¹⁾	L ¹¹⁾	H	H	H
Overvoltage	L	L	L	L	H	H	H
	H	L	L	L	H	H	H

L = "Low" Level
H = "High" Level

⁹⁾ Power Transistor off, high impedance, versions BTS 410H, BTS 412B; source for open load detection.

¹⁰⁾ low resistance to V_{bb} may be detected by no-load-detection

¹¹⁾ no current sink capability during undervoltage shutdown

internal pull up current

Options Overview

all versions: High-side switch, Input protection, ESD protection, load dump and reverse battery protection with 150 Ω in GND connection

Type	BTS	412 B	410D	410E	410F	410G	410H
Logic version		B	D	E	F	G	H
Overtemperature protection $T_j > 150$ °C, latch function ¹²⁾ $T_j > 150$ °C, with auto-restart on cooling		X	X		X		X
Short-circuit to GND protection switches off when $V_{bb} - V_{OUT} > 3.5$ V typ. (when first turned on after approx. 150 μ s) switches off when $V_{bb} - V_{OUT} > 8.6$ V typ. (when first turned on after approx. 150 μ s) Achieved through overtemperature protection		X	X	X	X		X
Open load detection in OFF-state with sensing current 30 μ A typ. in ON-state with sensing voltage drop across power transistor		X		X	X	X	X
Undervoltage shutdown with auto restart		X	X	X	X	X	X
Overvoltage shutdown with auto restart		X	X	X	X	X	X
Status feedback for overtemperature short circuit to GND short to V_{bb} open load undervoltage, overvoltage		X X X X X	X X X X X	X X X X X	X X X X X	X X X X X	X X X X X
Status output type CMOS Open drain		X X X	X X X		X X X		X X X
Output negative voltage transient limit (fast inductive load switch off) to -10 V typ		X	X	X	X	X	X
Load current limit high level (can handle loads with high inrush currents) low level (better protection of application)		X X	X X	X X		X X	X X

¹²⁾ Latch except when $V_{bb} - V_{OUT} < V_{ON(SC)}$ after shutdown. In most cases $V_{OUT} = 0$ V after shutdown ($V_{OUT} \neq 0$ V only if forced externally). So the device remains latched unless $V_{bb} < V_{ON(SC)}$ (see page 45). No latch between turn on and $t_{d(SC)}$.

Maximum allowable power dissipation
 $P_{tot} = f(TC)$

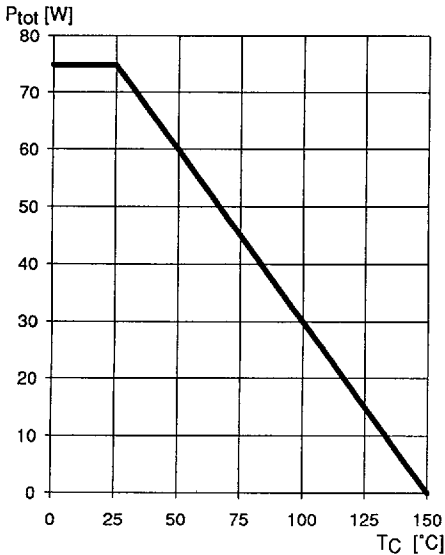

Typ. on-state resistance (V_{bb}-Pin to OUT-Pin)
 $R_{ON} = f(V_{bb}, I_L)$; $V_{IN} = \text{high}$, $T_J = 25^\circ\text{C}$
 R_{ON} [mOhm]

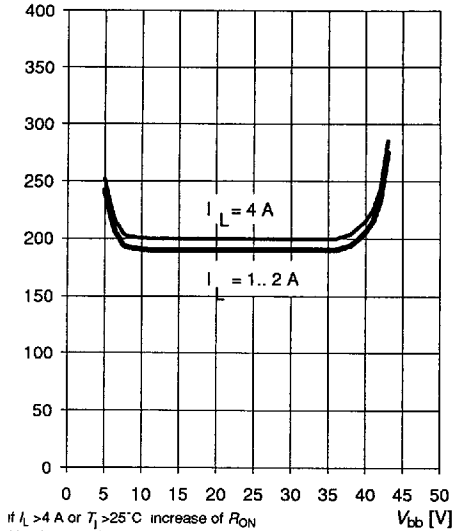

if $I_L > 4$ A or $T_J > 25^\circ\text{C}$ increase of R_{ON}
 (load current limits onset at $I_L \cdot R_{ON}$ approx 1 V)

On-state resistance (V_{bb}-Pin to OUT-Pin)

$R_{ON} = f(T_J)$; $V_{bb} = 9.35\text{V}$; $I_L = 1$ A; $V_{IN} = \text{high}$
 R_{ON} [mOhm]

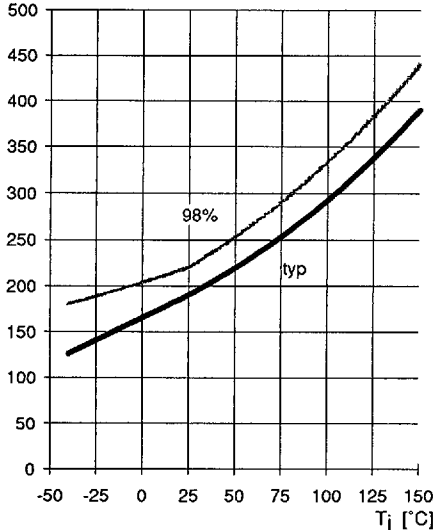

Max. case temperature vs DC load current

$T_C \text{ max} = f(I_L)$
 T_C [°C]

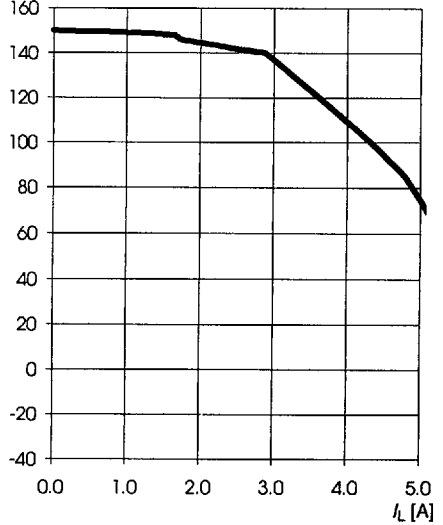

Typ. open load detect current

$I_{L(OL)} = f(T_j)$; $V_{bb}=9...35\text{ V}$; $V_{IN}=\text{high}$

$I_{L(OL)}$ [mA]

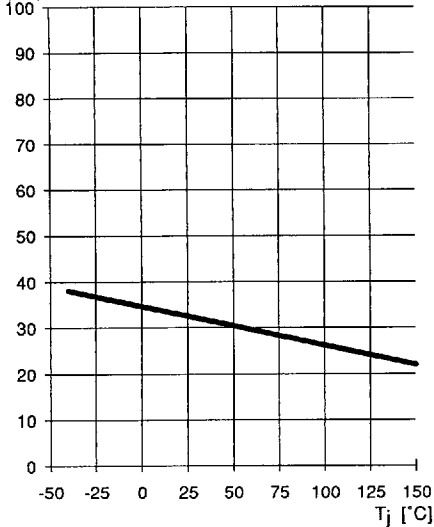

Typ. standby current

$I_{bb(off)} = f(T_j)$, $V_{bb}=9...35\text{ V}$, $V_{IN}=\text{low}$

$I_{bb(off)}$ [μA]

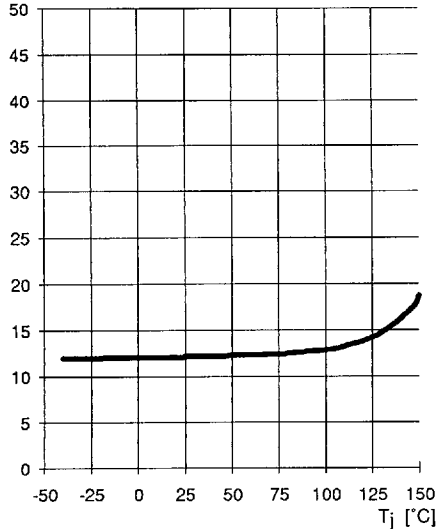

Typ. overload current

$I_{L(lim)} = f(t)$; $V_{bb}=12\text{ V}$, $V_{bb}-V_{OUT}=8\text{ V}$,

no heatsink, Parameter: T_j start

$I_{L(lim)}$ [A]

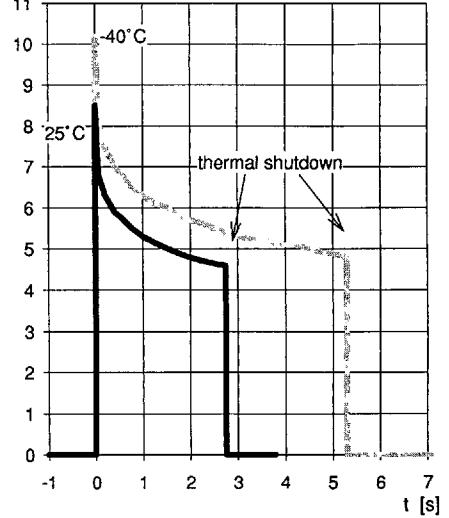

Overload Current

$I_{L(lim)} = f(t)$; $V_{bb}=12\text{ V}$, $V_{bb}-V_{OUT}=8\text{ V}$,

no heatsink

$I_{L(lim)}$ [A]

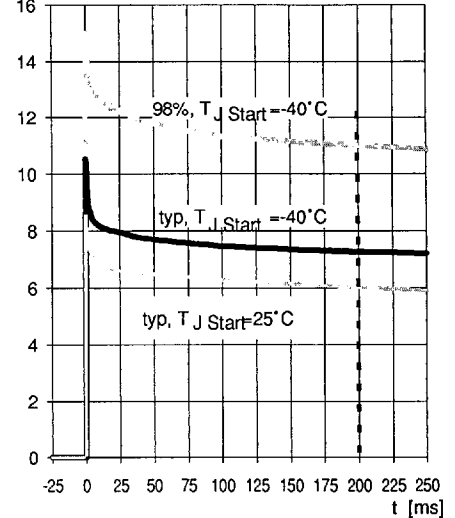

Typ. short circuit Current

$I_L(SC) = f(V_{ON}); T_j = 25^\circ C$

$I_L(SC) [A]$

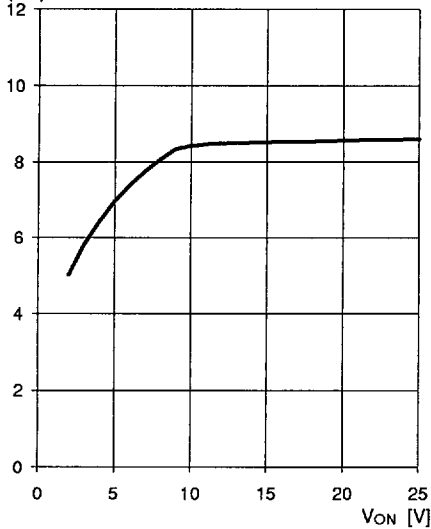

Typ. input turn on voltage threshold

$V_{IN}(T+) = f(T_j); V_{bb} = 9...35 V$

$V_{IN}(T+) [V]$

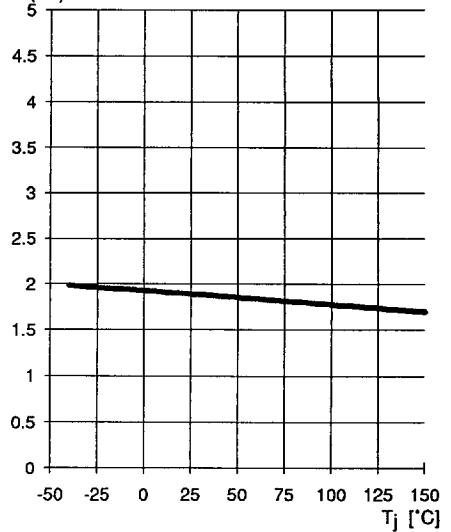

Short circuit current

max duration 350 μs prior to shutdown

$I_L(SC) = f(T_j); V_{bb} = 12 \dots 35 V;$

$I_L(SC) [A]$

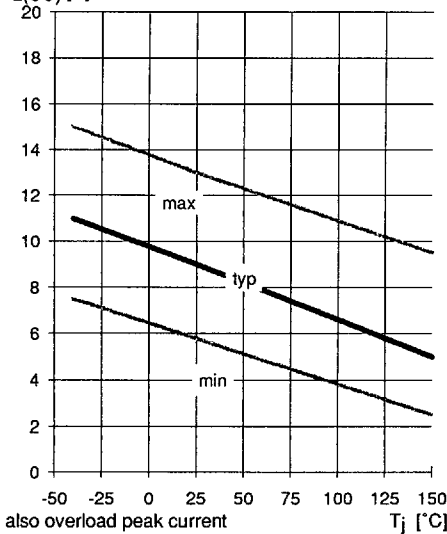

Typ. input current high

$I_{IN}(on) = f(T_j) V_{IN} = 3.5...5.5V$

$I_{IN}(on) [\mu A]$

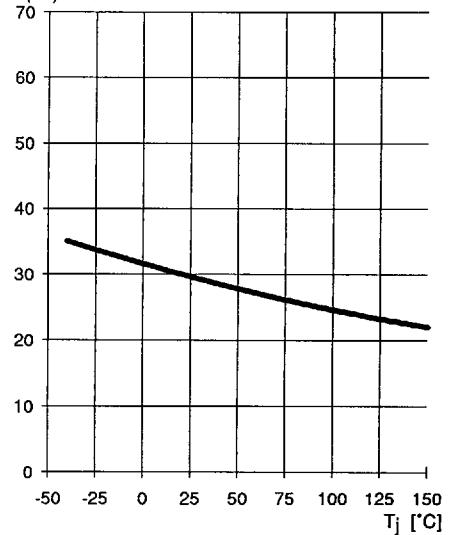

Typ. input current

$I_{IN} = f(V_{IN}), V_{bb} = 9...35V, T_j = 25^\circ C$

$I_{IN} [\mu A]$

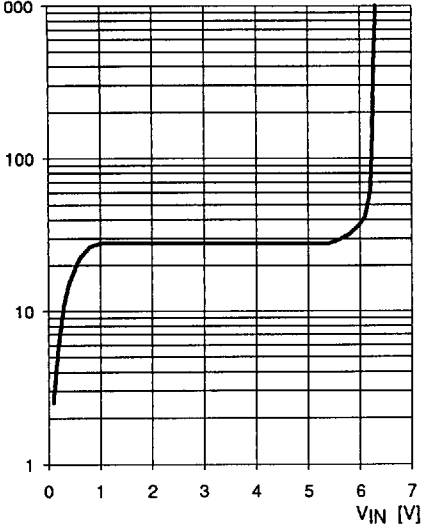

Typ. status zener limit voltage

$V_{ST(high)} = f(T_j)$

$V_{ST(high)} [V]$

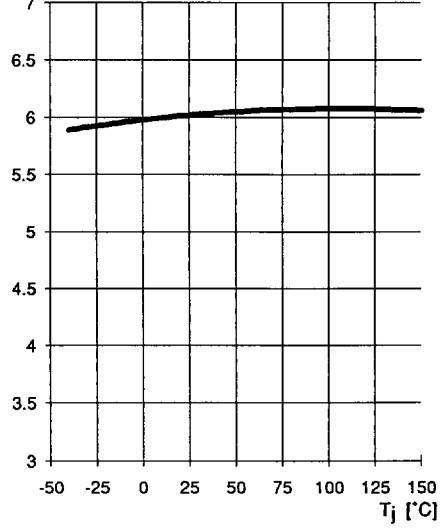

Typ. ground pin operating current

$I_{GND} = f(V_{bb}, T_j); V_{IN} = \text{high}$

$I_{GND} [mA]$

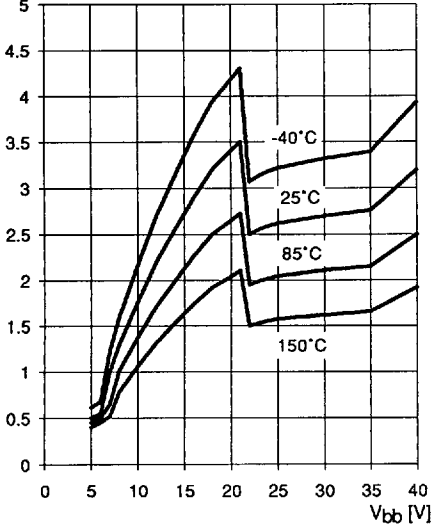

Typ. status low voltage

$V_{ST(low)} = f(I_{ST}), V_{bb} = 9...35V, T_j = 25^\circ C$

$V_{ST(low)} [V]$

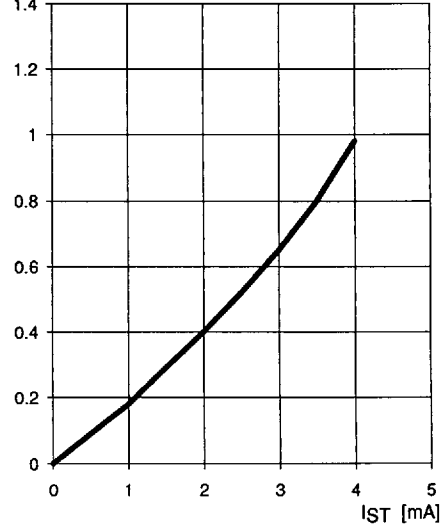

Timing diagrams

Figure 1a: V_{bb} turn on:

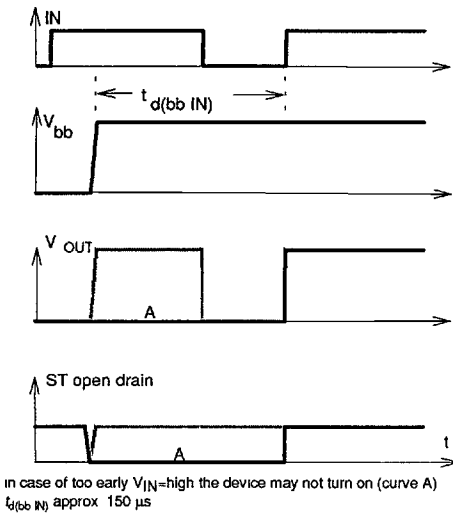
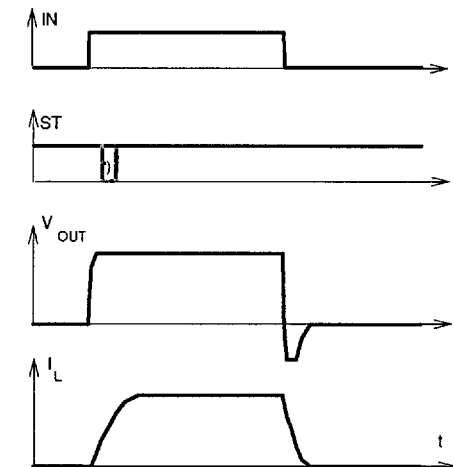

Figure 2a: Switching an inductive load,



*) if the time constant of load is too large, open-load-status may occur

Figure 3a: turn on into short circuit,

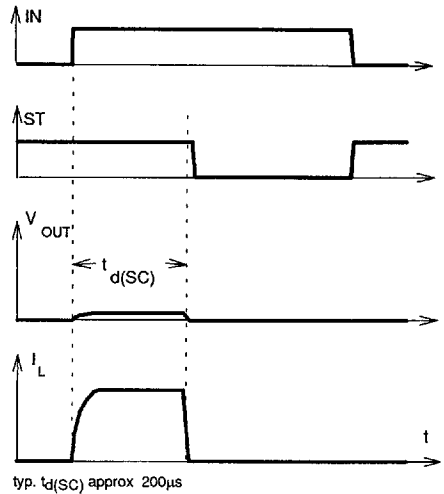

Figure 3b: short circuit while on:

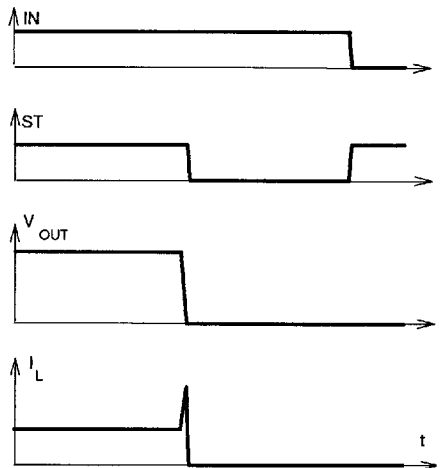
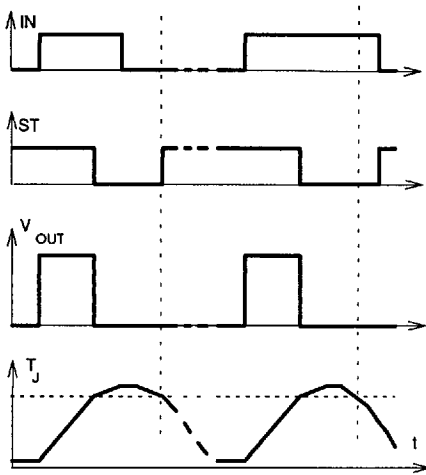

Figure 4a: overtemperature,

Reset if (IN=low) and ($T_J < T_{JT}$)



*) ST goes high, when V_{IN} =low and $T_J < T_{JT}$

Figure 5a: open load: detection in ON-state, turn on to open load

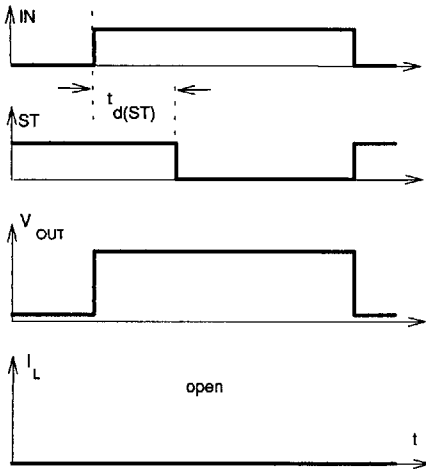
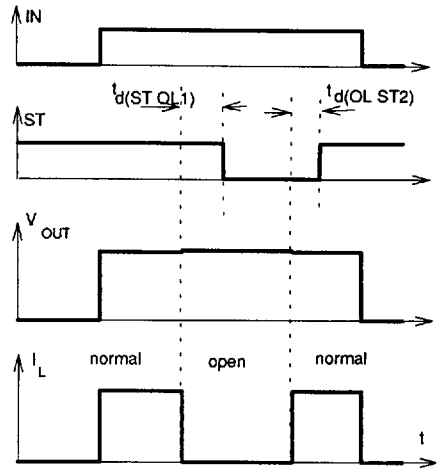

Figure 5b: open load: detection in ON-state, open load occurs in on-state



Package and ordering code

Standard

BTS 410 F	C67078-S5305-A5
-----------	-----------------

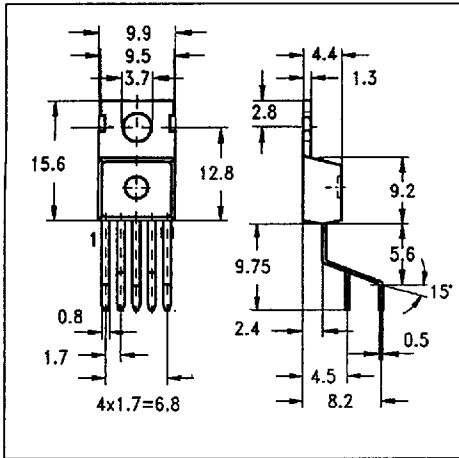

E3043

BTS 410 F	C67078-S5305-A14
-----------	------------------

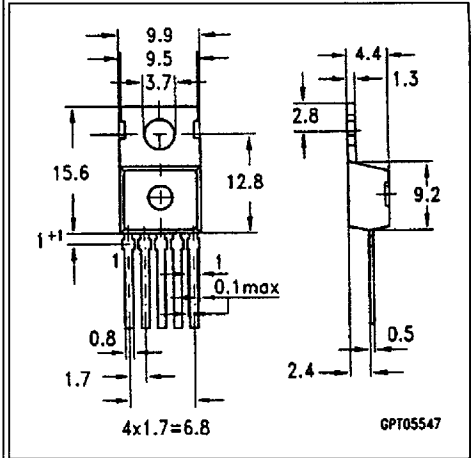

E3040

BTS 410 F	C67078-S5305-A9
-----------	-----------------

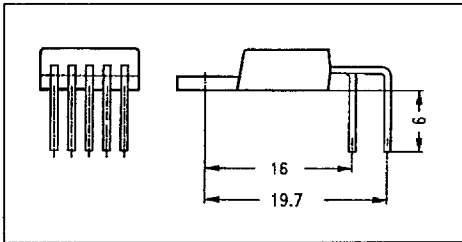

SMD

BTS 410 F E3062	Tube: C67078-S5303-A21
-----------------	------------------------

