

AVX
A KYOCERA GROUP COMPANY



AVX
RF Microwave/Thin-Film
Products

*AVX Microwave
Ask The World Of Us*

As one of the world's broadest line multilayer ceramic chip capacitor suppliers, and a major Thin Film RF/Microwave capacitor, inductor, directional coupler and low pass filter and microwave ceramic capacitor manufacturer, it is our mission to provide **First In Class** Technology, Quality and Service, by establishing progressive design, manufacturing and continuous improvement programs driving toward a single goal:

TOTAL CUSTOMER SATISFACTION

QV2000

Table of Contents

Company Profile	4
Thin-Film RF/Microwave Technology – Accu-F® / Accu-P®	5-24
Thin-Film Technology	6
Thin-Film Chip Capacitors	7
Thin-Film Chip Capacitors for RF Signal and Power Applications	8
Accu-F®	9
Accu-P®	10
0201 Typical Electrical Tables – Accu-P®	11
0402 Typical Electrical Tables – Accu-P®	12-13
0603 Typical Electrical Tables – Accu-F® / Accu-P®	14
0805 Typical Electrical Tables – Accu-F® / Accu-P®	15
1210 Typical Electrical Tables – Accu-P®	16
High Frequency Characteristics	17-19
Environmental / Mechanical Characteristics	20
Performance Characteristics RF Power Applications	21
Application Notes	22-23
Automatic Insertion Packaging	24
Thin-Film RF/Microwave Inductor Technology – Accu-L® – L0603/L0805	25-30
SMD High-Q RF Inductor – Accu-L®	26-29
Environmental Characteristics	29
Application Notes	30
Thin-Film RF/Microwave Directional Couplers – CP0402/CP0603/CP0805/DB0805 3dB 90°	31-67
CP0402 High Directivity LGA Termination	32-35
CP0603 High Directivity LGA Termination	36-40
CP0402 and CP0603 Test Jigs	41
CP0603 SMD Type	42-44
CP0603 SMD Type – High Directivity	45
CP0805 Type	46-49
CP0805 and CP0603 Test Jigs	50
DB0805 3dB 90° Couplers	51-62
DB0805 3dB 90° Test Jigs	63
Thin-Film RF/Microwave Harmonic Low Pass Filter – LP0603/LP0805	64-71
LP0603 Test Jigs	67-68
LP0805 Test Jigs	71
Thin-Film RF/Microwave Products – Designer Kits	72-74
RF/Microwave Multilayer Capacitors (MLC)	75-89
Porcelain Capacitors (+90±20ppm/°C)	76-79
• AQ06 (0.063" x 0.032") - Cap. Range: 0.1 to 120pF	
• AQ11; AQ12 (0.055" x 0.055") - Cap. Range: 0.1 to 100pF	
• AQ13; AQ14 (0.110" x 0.110") - Cap. Range: 0.1 to 1000pF	
Hi-Q NP0 Capacitors (0±30ppm/°C)	78
• AQ06 (0.063" x 0.032") - Cap. Range: 0.1 to 120pF	
• AQ11; AQ12 (0.055" x 0.055") - Cap. Range: 0.1 to 1000pF	
• AQ13; AQ14 (0.110" x 0.110") - Cap. Range: 0.1 to 5100pF	
Hi-K RF Capacitors (±15%)	78-79
• AQ12 (0.055" x 0.055") - Cap. Range: 0.001 to 0.010µF	
• AQ14 (0.110" x 0.110") - Cap. Range: 0.005 to 0.1µF	
MIL-PRF-55681 “BG” Voltage Temperature Limits (+90±20ppm/°C)	80-82
• CDR11BG; CDR12BG (0.055" x 0.055") - Failure Rate Level: M, P, R, S	
• CDR13BG; CDR14BG (0.110" x 0.110") - Failure Rate Level: M, P, R, S	
MIL-PRF-55681 “BP” Voltage Temperature Limits (0±30ppm/°C)	80-82
• CDR11BP; CDR12BP (0.055" x 0.055") - Failure Rate Level: M, P, R, S	
• CDR13BP; CDR14BP (0.110" x 0.110") - Failure Rate Level: M, P, R, S	
Performance Curves	83-87
Automatic Insertion Packaging	88
Hi-Q® High RF Power MLC Surface Mount Capacitors	89
RF/Microwave C0G (NP0) Capacitors	90-93
Ultra Low ESR “U” Series, C0G (NP0)	91-93
• 0402 (0.040" x 0.020"), 0603 (0.060" x 0.030"), 0805 (0.080" x 0.050"), 1210 (0.125" x 0.100")	
RF/Microwave AQ 12 & 14 and “U” Series Designer Kits	94-97
Introduction to Microwave Capacitors	98-110

Table of Contents

Company Profile	4	
Thin-Film RF/Microwave Technology – Accu-F® / Accu-P®	5-24	1
Thin-Film RF/Microwave Technology – Accu-L® L0603, L0805.....	25-30	2
Thin-Film RF/Microwave Directional Couplers – CP0402/CP0603/CP0805/DB0805 3dB 90°	31-63	3
Thin-Film RF/Microwave Harmonic Low Pass Filter – LP0603/LP0805	64-71	4
Thin-Film RF/Microwave Products – Designer Kits	72-74	5
RF/Microwave Multilayer Capacitors (MLC).....	75-89	6
RF/Microwave C0G (NP0) Capacitors	90-93	7
RF/Microwave AQ 12 & 14 and “U” Series Designer Kits	94-97	8
Introduction to Microwave Capacitors	98-110	9

AVX Corporation is a leading manufacturer of multilayer ceramic, thin film, tantalum, and glass capacitors, as well as other passive electronic components. These products are used in virtually every variety of electronic system today, including data processing, telecommunications, consumer/automotive electronics, military and aerospace systems, and instrumentation and process controls.

We continually strive to be the leader in all component segments we supply. RF/Microwave capacitors is a thrust business for us. AVX offers a broad line of RF/Microwave Chip Capacitors in a wide range of sizes, styles, and ratings.

The Thin-Film Products range illustrated in this catalog represents the state-of-the-art in RF Capacitors, Inductors, Directional Couplers and Low Pass Filters. The thin-film technology provides components that exhibit excellent batch-to-batch repeatability of electrical parameters at RF frequencies.

The Accu-F[®] and Accu-P[®] series of capacitors are available in ultra-tight tolerances ($\pm 0.02\text{pF}$) as well as non-standard capacitance values.

The Accu-L[®] series of inductors are ideally suited for applications requiring an extremely high Q and high current capability.

The CP0402/CP0603/CP0805 series of Directional Couplers cover the frequency range of 800 MHz to 6 GHz. They feature low insertion loss, high directivity and highly accurate coupling factors.

The LP0805 series of Low Pass Filters provide a rugged component in a small 0805 size package with excellent high frequency performance.

Another major series of microwave capacitors consists of both multilayer porcelain and ceramic capacitors for frequencies from 10 MHz to 4.2 GHz (AQ11 - 14 Series). Three sizes of specially designed ultra-low ESR COG (NP0) capacitors are covered for RF applications ("U" Series).

Ask the world of us. Call (843) 448-9411.

Or visit our website <http://www.avx.com>



Thin-Film Technology

Accu-F[®] / Accu-P[®]

Thin-Film RF/Microwave Capacitors

Thin-Film Technology

THE IDEAL CAPACITOR

The non-ideal characteristics of a real capacitor can be ignored at low frequencies. Physical size imparts inductance to the capacitor and dielectric and metal electrodes result in resistive losses, but these often are of negligible effect on the circuit. At the very high frequencies of radio communication (>100MHz) and satellite systems (>1GHz), these effects become important. Recognizing that a real capacitor will exhibit inductive and resistive impedances in addition to capacitance, the ideal capacitor for these high frequencies is an ultra low loss component which can be fully characterized in all parameters with total repeatability from unit to unit.

Until recently, most high frequency/microwave capacitors were based on fired-ceramic (porcelain) technology. Layers of ceramic dielectric material and metal alloy electrode paste are interleaved and then sintered in a high temperature oven. This technology exhibits component variability in dielectric quality (losses, dielectric constant and insulation resistance), variability in electrode conductivity and variability in physical size (affecting inductance). An alternate thin-film technology has been developed which virtually eliminates these variances. It is this technology which has been fully incorporated into Accu-F® and Accu-P® to provide high frequency capacitors exhibiting truly ideal characteristics.

The main features of Accu-F® and Accu-P® may be summarized as follows:

- High purity of electrodes for very low and repeatable ESR.
- Highly pure, low-K dielectric for high breakdown field, high insulation resistance and low losses to frequencies above 40GHz.
- Very tight dimensional control for uniform inductance, unit to unit.
- Very tight capacitance tolerances for high frequency signal applications.

This accuracy sets apart these Thin-Film capacitors from ceramic capacitors so that the term Accu has been employed as the designation for this series of devices, an abbreviation for “accurate.”

THIN-FILM TECHNOLOGY

Thin-film technology is commonly used in producing semiconductor devices. In the last two decades, this technology has developed tremendously, both in performance and in process control. Today’s techniques enable line definitions of below 1µm, and the controlling of thickness of layers at 100Å (10⁻²µm). Applying this technology to the manufacture of capacitors has enabled the development of components where both electrical and physical properties can be tightly controlled.

The thin-film production facilities at AVX consist of:

- Class 1000 clean rooms, with working areas under laminar-flow hoods of class 100, (below 100 particles per cubic foot larger than 0.5µm).
- High vacuum metal deposition systems for high-purity electrode construction.
- Photolithography equipment for line definition down to 2.0µm accuracy.
- Plasma-enhanced CVD for various dielectric depositions (CVD=Chemical Vapor Deposition).
- High accuracy, microprocessor-controlled dicing saws for chip separation.
- High speed, high accuracy sorting to ensure strict tolerance adherence.

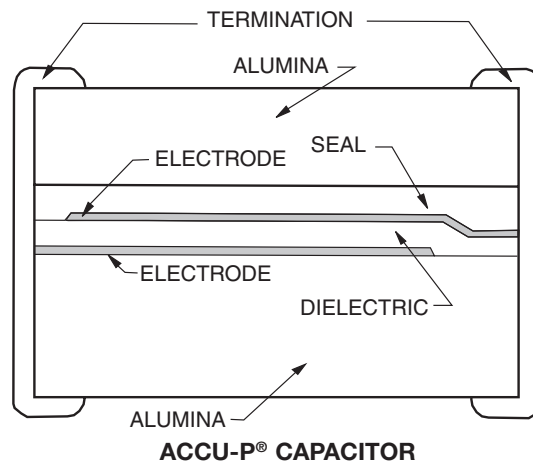

Accu-F® / Accu-P®

Thin-Film Chip Capacitors

ACCU-F® TECHNOLOGY

The use of very low-loss dielectric materials, silicon dioxide and silicon oxynitride, in conjunction with highly conductive electrode metals results in low ESR and high Q. These high-frequency characteristics change at a slower rate with increasing frequency than for ceramic microwave capacitors.

Because of the thin-film technology, the above-mentioned frequency characteristics are obtained without significant compromise of properties required for surface mounting.

The main Accu-F® properties are:

- Internationally agreed sizes with excellent dimensional control.
- Small size chip capacitors (0603) are available.
- Tight capacitance tolerances.
- Low ESR at VHF, UHF and microwave frequencies.
- High stability with respect to time, temperature, frequency and voltage variation.
- Nickel/solder-coated terminations to provide excellent solderability and leach resistance.

ACCU-F® FEATURES

Accu-F® meets the fast-growing demand for low-loss (high-Q) capacitors for use in surface mount technology especially for the mobile communications market, such as cellular radio of 450 and 900 MHz, UHF walkie-talkies, UHF cordless telephones to 2.3 GHz, low noise blocks at 11-12.5 GHz and for other VHF, UHF and microwave applications.

Accu-F® is currently unique in its ability to offer very low capacitance values (0.1pF) and very tight capacitance tolerances (±0.05pF). Typically Accu-F® will be used in small signal applications in VCO's, matching networks, filters, etc.

Inspection test and quality control procedures in accordance with ISO 9001, CECC, IECQ and USA MIL Standards yield products of the highest quality.

APPLICATIONS

- Cellular Communications
- CT2/PCN (Cordless Telephone/Personal Comm. Networks)
- Satellite TV
- Cable TV
- GPS (Global Positioning Systems)
- Vehicle Location Systems
- Vehicle Alarm Systems
- Paging
- Military Communications

- Radar Systems
- Video Switching
- Test & Measurements
- Filters
- VCO's
- Matching Networks

APPROVALS

- ISO 9001

ACCU-P® TECHNOLOGY

As in the Accu-F® series the use of very low-loss dielectric materials (silicon dioxide and silicon oxynitride) in conjunction with highly conductive electrode metals results in low ESR and high Q. At high frequency these characteristics change at a slower rate with increasing frequency than conventional ceramic microwave capacitors. Using thin-film technology, the above-mentioned frequency characteristics are obtained without significant compromise of properties required for surface mounting. The use of high thermal conductivity materials results in excellent RF power handling capabilities.

The main Accu-P® properties are:

- Enhanced RF power handling capability.
- Improved mechanical characteristics.
- Internationally agreed sizes with excellent dimensional control.
- Ultra Small size chip capacitors (0201) are available.
- Tight capacitance tolerances.
- Low ESR at UHF, VHF, and microwave frequencies.
- High-stability with respect to time, temperature, frequency and voltage variation.
- High temperature nickel/solder-coated terminations as standard to provide excellent solderability and leach resistance.

ACCU-P® FEATURES

- Minimal batch to batch variability of parameters at high frequency.
- The Accu-P® has the same unique features as the Accu-F® capacitor such as low ESR, high Q, availability of very low capacitance values and very tight capacitance tolerances.
- The RF power handling capability of the Accu-P® allows for its usage in both small signal and RF power applications.
- Inspection, test and quality control procedures in accordance with ISO 9001, CECC, IECQ and USA MIL Standards guarantee product of the highest quality.
- Hand soldering Accu-P®: Due to their construction utilizing relatively high thermal conductivity materials, Accu-P's have become the preferred device in R & D labs and production environments where hand soldering is used. Accu-P's are available in all sizes and are electrically identical to their Accu-F counterparts.

APPLICATIONS

- Cellular Communications
- CT2/PCN (Cordless Telephone/Personal Comm. Networks)
- Satellite TV
- Cable TV
- GPS (Global Positioning Systems)
- Vehicle Location Systems
- Vehicle Alarm Systems
- Paging
- Military Communications

- Radar Systems
- Video Switching
- Test & Measurements
- Filters
- VCO's
- Matching Networks
- RF Amplifiers

APPROVALS

- ISO 9001

Accu-F® */ Accu-P®

Thin-Film Chip Capacitors for RF Signal and Power Applications

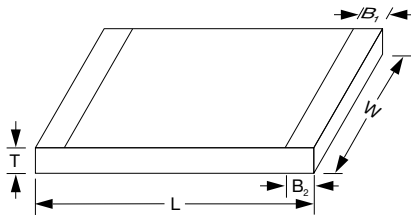

1

ACCU-F® *(Signal Type Capacitors)

	0603	0805
L	1.60±0.1 (0.063±0.004)	2.01±0.1 (0.079±0.004)
W	0.81±0.1 (0.032±0.004)	1.27±0.1 (0.050±0.004)
T	0.63±0.1 (0.025±0.004)	0.63±0.1 (0.025±0.004)
B	0.30±0.1 (0.012±0.004)	0.30±0.1 (0.012±0.004)

*Not recommended for new designs. Accu-P's are recommended. **DIMENSIONS:** millimeters (inches)

ACCU-P® (Signal and Power Type Capacitors)

	0201	0402*	0603*	0805*	1210
L	0.60±0.05 (0.023±0.002)	1.00±0.1 (0.039±0.004)	1.60±0.1 (0.063±0.004)	2.01±0.1 (0.079±0.004)	3.02±0.1 (0.119±0.004)
W	0.325±0.050 (0.0128±0.002)	0.55±0.07 (0.022±0.003)	0.81±0.1 (0.032±0.004)	1.27±0.1 (0.050±0.004)	2.5±0.1 (0.100±0.004)
T	0.225±0.050 (0.009±0.002)	0.40±0.1 (0.016±0.004)	0.63±0.1 (0.025±0.004)	0.93±0.2 (0.036±0.008)	0.93±0.2 (0.036±0.008)
B₁	0.10±0.10 (0.004±0.004)	0.00±0.1/-0 (0.000±0.004/-0)	0.35±0.15 (0.014±0.006)	0.30±0.1 (0.012±0.004)	0.43±0.1 (0.017±0.004)
B₂	0.15±0.05 (0.006±0.002)	0.20±0.1 (0.008±0.004)	0.35±0.15 (0.014±0.006)	0.30±0.1 (0.012±0.004)	0.43±0.1 (0.017±0.004)

*Mount Black Side Up **DIMENSIONS:** millimeters (inches)

HOW TO ORDER

0805	5	J	120	G	A	W	TR
Size	0201*	5	0805	1210*			
Voltage	1 = 100V	5 = 50V	3 = 25V	Y = 16V	Z = 10V		
Temperature Coefficient (1)		J = 0±30ppm/°C (-55°C to +125°C)	K = 0±60ppm/°C (-55°C to +125°C)				
Capacitance							
Tolerance for C≤2.0pF*							
Specification Code							
Termination Code							
Packaging Code							

* Accu-P ONLY

(1) TC's shown are per EIA/IEC Specifications.

* Tolerances as tight as ±0.01pF are available. Please consult the factory.

ELECTRICAL SPECIFICATIONS

Operating and Storage Temperature Range	-55°C to +125°C
Temperature Coefficients (1)	0 ± 30ppm/°C dielectric code "J" / 0 ± 60ppm/°C dielectric code "K"
Capacitance Measurement	1 MHz, 1 Vrms
Insulation Resistance (IR)	≥10 ¹¹ Ohms (≥10 ¹⁰ Ohms for 0201 and 0402 size)
Proof Voltage	2.5 U _R for 5 secs.
Aging Characteristic	Zero
Dielectric Absorption	0.01%

(1) TC's shown are per EIA/IEC Specifications.



Signal Type Capacitors

Accu-F® Capacitance Ranges (pF)

TEMP. COEFFICIENT CODE

“J” = 0±30ppm/°C
(-55°C to +125°C)⁽²⁾

Size		0603			0805		
Size Code		0603			0805		
Voltage		100	50	25	100	50	25
Cap in pF ⁽¹⁾	Cap code						
0.1	— 0R1						
0.2	— 0R2						
0.3	— 0R3						
0.4	— 0R4						
0.5	— 0R5						
0.6	— 0R6						
0.7	— 0R7						
0.8	— 0R8						
0.9	— 0R9						
1.0	— 1R0						
1.2	— 1R2						
1.5	— 1R5						
1.8	— 1R8						
2.2	— 2R2						
2.7	— 2R7						
3.3	— 3R3						
3.9	— 3R9						
4.7	— 4R7						
5.6	— 5R6						
6.8	— 6R8						
8.2	— 8R2						
10	— 100						
12	— 120						
15	— 150						
18	— 180						
22	— 220						
27	— 270						
33	— 330						
39	— 390						
47	— 470						
56	— 560						
68	— 680						
82	— 820						
100	— 101						
120	— 121						
150	— 151						

⁽¹⁾ For capacitance values higher than listed in table, please consult factory.

⁽²⁾ TC shown is per EIA/IEC Specifications.

TEMP. COEFFICIENT CODE

“K” = 0±60ppm/°C
(-55°C to +125°C)⁽²⁾

Size		0603			0805		
Size Code		0603			0805		
Voltage		100	50	25	100	50	25
Cap in pF ⁽¹⁾	Cap code						
0.1	— 0R1						
0.2	— 0R2						
0.3	— 0R3						
0.4	— 0R4						
0.5	— 0R5						
0.6	— 0R6						
0.7	— 0R7						
0.8	— 0R8						
0.9	— 0R9						
1.0	— 1R0						
1.2	— 1R2						
1.5	— 1R5						
1.8	— 1R8						
2.2	— 2R2						
2.7	— 2R7						
3.3	— 3R3						
3.9	— 3R9						
4.7	— 4R7						
5.6	— 5R6						
6.8	— 6R8						
8.2	— 8R2						
10	— 100						
12	— 120						
15	— 150						
18	— 180						
22	— 220						
27	— 270						
33	— 330						
39	— 390						
47	— 470						
56	— 560						
68	— 680						
82	— 820						
100	— 101						
120	— 121						
150	— 151						

⁽¹⁾ For capacitance values higher than listed in table, please consult factory.

⁽²⁾ TC shown is per EIA/IEC Specifications.

Intermediate values are available within the indicated range.

*Not recommended for new designs.
Accu-P's are recommended.

Signal and Power Type Capacitors

Accu-P® Capacitance Ranges (pF)

TEMP. COEFFICIENT CODE

“J” = 0±30ppm/°C (-55°C to +125°C)⁽²⁾

Size		0201			0402			0603		0805			1210	
Voltage		25	16	10	25	16	10	50	25	100	50	25	100	50
Cap in pF ⁽¹⁾	Cap code													
0.1	— 0R1													
0.2	— 0R2													
0.3	— 0R3													
0.4	— 0R4													
0.5	— 0R5													
0.6	— 0R6													
0.7	— 0R7													
0.8	— 0R8													
0.9	— 0R9													
1.0	— 1R0													
1.1	— 1R1													
1.2	— 1R2													
1.3	— 1R3													
1.4	— 1R4													
1.5	— 1R5													
1.6	— 1R6													
1.7	— 1R7													
1.8	— 1R8													
1.9	— 1R9													
2.0	— 2R0													
2.1	— 2R1													
2.2	— 2R2													
2.3	— 2R3													
2.4	— 2R4													
2.5	— 2R5													
2.6	— 2R6													
2.7	— 2R7													
2.8	— 2R8													
2.9	— 2R9													
3.0	— 3R0													
3.1	— 3R1													
3.2	— 3R2													
3.3	— 3R3													
3.4	— 3R4													
3.5	— 3R5													
3.6	— 3R6													
3.7	— 3R7													
3.8	— 3R8													
3.9	— 3R9													
4.0	— 4R0													
4.1	— 4R1													
4.2	— 4R2													
4.3	— 4R3													
4.4	— 4R4													
4.5	— 4R5													
4.6	— 4R6													
4.7	— 4R7													
5.1	— 5R1													
5.6	— 5R6													
6.2	— 6R2													
6.8	— 6R8													
7.5	— 7R5													
8.2	— 8R2													
9.1	— 9R1													
10.0	— 100													
11.0	— 110													
12.0	— 120													
13.0	— 130													
14.0	— 140													
15.0	— 150													
16.0	— 160													
17.0	— 170													
18.0	— 180													
22.0	— 220													
24.0	— 240													
27.0	— 270													
30.0	— 300													
33.0	— 330													
39.0	— 390													
47.0	— 470													
56.0	— 560													
68.0	— 680													

(1) For capacitance values higher than listed in table, please consult factory.
 (2) TC shown is per EIA/IEC Specifications.
 These values are produced with “K” temperature coefficient code only.

TEMP. COEFFICIENT CODE

“K” = 0±60ppm/°C (-55°C to +125°C)⁽²⁾

Size		0805			1210	
Voltage		100	50	25	100	50 ⁽³⁾
Cap in pF ⁽¹⁾	Cap code					
0.1	— 0R1					
0.2	— 0R2					
0.3	— 0R3					
0.4	— 0R4					
0.5	— 0R5					
0.6	— 0R6					
0.7	— 0R7					
0.8	— 0R8					
0.9	— 0R9					
1.0	— 1R0					
1.1	— 1R1					
1.2	— 1R2					
1.3	— 1R3					
1.4	— 1R4					
1.5	— 1R5					
1.6	— 1R6					
1.7	— 1R7					
1.8	— 1R8					
1.9	— 1R9					
2.0	— 2R0					
2.1	— 2R1					
2.2	— 2R2					
2.3	— 2R3					
2.4	— 2R4					
2.5	— 2R5					
2.6	— 2R6					
2.7	— 2R7					
2.8	— 2R8					
2.9	— 2R9					
3.0	— 3R0					
3.1	— 3R1					
3.2	— 3R2					
3.3	— 3R3					
3.4	— 3R4					
3.5	— 3R5					
3.6	— 3R6					
3.7	— 3R7					
3.8	— 3R8					
3.9	— 3R9					
4.0	— 4R0					
4.1	— 4R1					
4.2	— 4R2					
4.3	— 4R3					
4.4	— 4R4					
4.5	— 4R5					
4.6	— 4R6					
4.7	— 4R7					
5.1	— 5R1					
5.6	— 5R6					
6.2	— 6R2					
6.8	— 6R8					
7.5	— 7R5					
8.2	— 8R2					
9.1	— 9R1					
10.0	— 100					
11.0	— 110					
12.0	— 120					
13.0	— 130					
14.0	— 140					
15.0	— 150					
16.0	— 160					
17.0	— 170					
18.0	— 180					
22.0	— 220					
24.0	— 240					
27.0	— 270					
30.0	— 300					
33.0	— 330					
39.0	— 390					
47.0	— 470					
56.0	— 560					
68.0	— 680					

(1) For capacitance values higher than listed in table, please consult factory.
 (2) TC shown is per EIA/IEC Specifications.
 (3) For 50 volt range, please consult factory.

Intermediate values are available within the indicated range.

0201 Typical Electrical Tables

Capacitance @ 1 MHz (pF)	Self Resonance Frequency (GHz) Typical	250MHz			500MHz			750MHz			1000MHz			1250MHz		
		Typ. C(eff) (pF)	Typ. Q	Typ. ESR (mΩ)	Typ. C(eff) (pF)	Typ. Q	Typ. ESR (mΩ)	Typ. C(eff) (pF)	Typ. Q	Typ. ESR (mΩ)	Typ. C(eff) (pF)	Typ. Q	Typ. ESR (mΩ)	Typ. C(eff) (pF)	Typ. Q	Typ. ESR (mΩ)
0.8	9.1	0.84	2154	360	0.84	630	603	0.85	424	594	0.85	327	577	0.86	255	588
1.2	7.6	1.21	1375	405	1.21	525	517	1.22	341	527	1.23	267	503	1.23	208	515
1.8	6.3	1.84	1298	271	1.85	520	341	1.86	337	347	1.87	270	326	1.88	201	347
2.2	5.7	2.23	1355	214	2.24	512	281	2.25	335	284	2.27	264	270	2.29	199	284
3.3	4.6	3.29	1295	156	3.31	430	230	3.33	285	230	3.36	220	223	3.40	159	242
3.9	4.3	3.91	1902	93	3.93	460	181	3.97	298	185	4.02	227	181	4.08	163	198
4.7	3.9	4.71	1677	84	4.74	391	174	4.80	252	178	4.87	181	183	4.97	130	200
5.6	3.6	5.62	1391	84	5.67	370	154	5.74	257	148	5.83	195	144	5.95	140	157
6.8	3.3	6.77	1135	84	6.83	314	149	6.91	217	142	7.03	164	139	7.18	118	151

Capacitance @ 1 MHz (pF)	Self Resonance Frequency (GHz) Typical	1500MHz			1750MHz			2250MHz			2500MHz			2750MHz		
		Typ. C(eff) (pF)	Typ. Q	Typ. ESR (mΩ)	Typ. C(eff) (pF)	Typ. Q	Typ. ESR (mΩ)	Typ. C(eff) (pF)	Typ. Q	Typ. ESR (mΩ)	Typ. C(eff) (pF)	Typ. Q M	Typ. ESR (mΩ)	Typ. C(eff) (pF)	Typ. Q	Typ. ESR (mΩ)
0.8	9.1	0.86	204	611	0.87	168	631	0.88	141	587	0.89	126	571	0.90	122	532
1.2	7.6	1.24	155	565	1.26	129	577	1.28	92	570	1.30	89	566	1.31	81	558
1.8	6.3	1.90	148	388	1.92	123	395	1.96	96	395	1.99	83	396	2.02	74	397
2.2	5.7	2.32	145	320	2.34	123	322	2.41	93	329	2.46	81	328	2.50	72	330
3.3	4.6	3.45	119	266	3.50	101	263	3.63	74	277	3.73	64	276	3.84	55	281
3.9	4.3	4.16	122	216	4.25	103	214	4.46	75	224	4.63	64	223	4.79	56	225
4.7	3.9	5.08	99	213	5.23	83	212	5.55	60	221	5.83	50	222	6.10	43	224
5.6	3.6	6.11	108	166	6.31	91	164	6.76	64	174	7.16	53	175	7.56	45	141
6.8	3.3	7.38	93	155	7.63	76	158	8.22	54	166	8.74	44	169	9.29	37	173



0402 Typical Electrical Tables



Table with 22 columns: Capacitance & Tolerance* @ 1 MHz (pF), Self Resonance Frequency (GHz) Typical, Ref Freq (MHz), Typ. C(eff) (pF), Typ. Q, Typ. ESR (Ω), Ref Freq (MHz), Typ. C(eff) (pF), Typ. Q, Typ. ESR (Ω), Ref Freq (MHz), Typ. C(eff) (pF), Typ. Q, Typ. ESR (Ω), Ref Freq (MHz), Typ. C(eff) (pF), Typ. Q, Typ. ESR (Ω), Ref Freq (MHz), Typ. C(eff) (pF), Typ. Q, Typ. ESR (Ω). Rows include various capacitance values like 0.1±0.05, 0.2±0.05, etc., up to 22.0±1%.

* Other tolerances are available, see page 8

0603 Typical Electrical Tables

1

Capacitance & Tolerance* @ 1 MHz (pF)	Self Resonance Frequency (GHz)	Ref Freq. MHz	Effective Capacitance Max/Min (pF)	Max ESR (Ω)	Ref Freq. MHz	Effective Capacitance Max/Min (pF)	Max ESR (Ω)	Ref Freq. MHz	Effective Capacitance Max/Min (pF)	Max ESR (Ω)	Ref Freq. MHz	Effective Capacitance Max/Min (pF)	Max ESR (Ω)
0.1±0.05	18.0		N/A	N/A	N/A	N/A	N/A	N/A	N/A	N/A	N/A	N/A	N/A
0.2±0.05	12.7		N/A	N/A	N/A	N/A	N/A	N/A	N/A	N/A	N/A	N/A	N/A
0.3±0.05	10.4		N/A	N/A	N/A	N/A	N/A	N/A	N/A	N/A	N/A	N/A	N/A
0.4±0.05	9.0		N/A	N/A	N/A	N/A	N/A	N/A	N/A	N/A	N/A	N/A	N/A
0.5±0.05	8.1		N/A	N/A	N/A	N/A	N/A	N/A	N/A	N/A	N/A	N/A	N/A
0.6±0.10	7.4		N/A	N/A	N/A	N/A	N/A	N/A	N/A	N/A	N/A	N/A	N/A
0.7±0.10	6.8		N/A	N/A	N/A	N/A	N/A	N/A	N/A	N/A	N/A	N/A	N/A
0.8±0.10	6.4		N/A	N/A	N/A	N/A	N/A	N/A	N/A	N/A	N/A	N/A	N/A
0.9±0.10	6.0		N/A	N/A	N/A	N/A	N/A	N/A	N/A	N/A	N/A	N/A	N/A
1.0±0.10	5.7	245	1.15/0.90	.280	491	1.10/0.90	.220	738	1.10/0.90	.220	987	1.15/0.90	.300
1.1±0.10	5.4	244	1.25/1.00	.270	490	1.25/1.00	.210	736	1.11/1.00	.210	985	1.25/1.00	.290
1.2±0.10	5.2	243	1.35/1.10	.260	487	1.35/1.05	.200	734	1.40/1.05	.210	981	1.35/1.05	.280
1.3±0.10	5.0	242	1.45/1.15	.260	486	1.45/1.15	.200	732	1.45/1.15	.200	974	1.45/1.15	.270
1.4±0.10	4.8	241	1.55/1.25	.250	485	1.55/1.25	.190	731	1.45/1.25	.200	977	1.55/1.25	.260
1.5±0.10	4.7	241	1.65/1.35	.250	484	1.65/1.35	.180	729	1.65/1.35	.190	976	1.70/1.35	.250
1.6±0.10	4.5	240	1.75/1.45	.240	483	1.75/1.45	.180	727	1.75/1.45	.190	973	1.80/1.50	.250
1.7±0.10	4.4	240	1.85/1.55	.230	482	1.85/1.60	.170	725	1.85/1.60	.180	971	1.90/1.60	.250
1.8±0.10	4.2	239	2.10/1.70	.220	479	2.10/1.70	.160	723	2.10/1.70	.170	969	2.15/1.70	.250
1.9±0.10	4.1	239	2.15/1.78	.210	478	2.15/1.80	.160	721	2.15/1.80	.167	967	2.20/1.80	.240
2.0±0.10	4.0	238	2.11/1.80	.205	477	2.11/1.80	.155	720	2.11/1.80	.165	966	2.25/1.90	.230
2.1±0.10	3.9	237	2.25/1.95	.200	475	2.25/1.98	.150	718	2.35/1.98	.162	964	2.35/2.00	.220
2.2±0.10	3.8	236	2.40/2.05	.190	474	2.45/2.05	.145	717	2.42/2.05	.160	962	2.45/2.10	.210
2.4±0.25	3.7	234	2.70/2.15	.175	471	2.75/2.15	.140	713	2.80/2.15	.150	958	2.80/2.15	.200
2.7±0.25	3.5	232	3.00/2.45	.160	468	3.10/2.45	.125	709	3.10/2.45	.145	954	3.15/2.48	.190
3.0±0.25	3.3	230	3.40/2.75	.150	465	3.40/2.75	.120	706	3.40/2.75	.140	951	3.60/2.80	.170
3.3±0.25	3.1	226	3.60/3.05	.130	459	3.70/3.05	.120	699	3.70/3.05	.130	945	3.80/3.10	.165
3.6±0.25	3.0	224	3.90/3.30	.128	456	4.25/3.35	.119	697	3.90/3.35	.125	942	4.10/3.40	.160
3.9±0.25	2.9	223	4.20/3.65	.125	455	4.35/3.70	.115	695	4.90/3.75	.120	940	5.15/3.75	.150
4.3±0.25	2.7	220	4.60/4.00	.122	451	4.80/4.05	.117	692	5.10/4.05	.115	937	5.30/4.05	.150
4.7±0.25	2.6	218	5.00/4.45	.120	448	5.20/4.45	.110	689	5.30/4.50	.115	935	5.50/4.55	.145
5.1±0.25	2.5	216	5.40/4.85	.115	445	5.70/4.89	.105	686	6.00/4.90	.115	931	6.20/5.00	.140
5.6±0.25	2.4	214	5.90/5.35	.110	443	6.10/5.35	.100	684	6.15/5.40	.110	929	6.50/5.50	.135
6.2±0.25	2.3	211	6.50/5.95	.105	439	6.90/5.95	.099	680	7.10/6.00	.110	927	8.00/6.10	.130
6.8±0.25	2.2	208	7.20/6.55	.100	435	7.25/6.55	.099	677	7.50/6.60	.110	925	9.00/6.65	.130
7.5±0.50	2.1	205	8.10/7.00	.095	432	8.10/7.00	.099	675	8.20/7.00	.110	925	9.50/7.05	.125
8.2±0.50	2.0	202	8.80/7.70	.090	429	8.80/7.70	.098	672	9.00/7.70	.110	921	10.00/7.80	.125
9.1±0.50	1.9	200	9.80/8.60	.090	425	10.95/8.65	.098	670	12.00/9.00	.110	919	13.00/9.10	.120
10±5%	1.8	195	10.70/9.50	.085	422	11.60/9.50	.097	667	12.50/9.60	.110	917	16.00/9.90	.120
11±5%	1.7	191	11.60/10.90	.085	420	12.20/10.60	.095	665	13.20/10.50	.110	916	17.00/10.00	.120
12±5%	1.6	189	12.90/11.40	.085	418	13.40/11.50	.095	663	14.60/11.90	.110	914	18.00/12.00	.120
13±5%	1.6	187	13.10/12.90	.080	416	14.00/13.00	.095	661	16.00/13.50	.110	913	21.00/14.00	.120
14±5%	1.5	185	14.90/13.25	.080	414	16.90/14.00	.090	660	19.00/15.00	.110	912	26.00/15.00	.120
15±5%	1.5	182	15.90/14.25	.080	412	17.50/15.30	.090	659	21.00/16.50	.100	911	29.00/17.00	.120
16±5%	1.4	179	17.00/15.15	.070	410	18.00/15.90	.085	657	22.00/17.00	.100	910	30.00/18.00	.120
18±5%	1.3	176	19.50/17.00	.070	408	20.20/17.10	.085	656	23.70/19.00	.100	908	33.00/21.00	.120
22±5%	1.2	170	24.00/20.90	.066	404	25.00/20.90	.080	654	28.00/21.00	.10	906	39.00/21.50	.120
24±5%	1.2	168	26.00/22.80	.066	403	30.00/23.00	.080	653	N/A	.10	905	N/A	.120
27±5%	1.1	165	29.00/25.60	.065	402	36.00/27.00	.080	652	N/A	.10	905	N/A	.120
30±5%	1.0	163	32.00/28.50	.064	401	40.00/30.00	.080	651	N/A	.10	904	N/A	.120
33±5%	1.0	160	37.65/31.35	.064	400	45.00/33.00	.080	650	N/A	.10	904	N/A	.120

* Other tolerances are available, see page 8

0805 Typical Electrical Tables

Capacitance & Tolerance* @ 1 MHz (pF)	Self Resonance Frequency (GHz)	Ref Freq. MHz	Effective Capacitance Max/Min (pF)	Max ESR (Ω)	Ref Freq. MHz	Effective Capacitance Max/Min (pF)	Max ESR (Ω)	Ref Freq. MHz	Effective Capacitance Max/Min (pF)	Max ESR (Ω)	Ref Freq. MHz	Effective Capacitance Max/Min (pF)	Max ESR (Ω)
0.1±0.05			N/A	N/A	N/A	N/A	N/A	N/A	N/A	N/A	N/A	N/A	N/A
0.2±0.05			N/A	N/A	N/A	N/A	N/A	N/A	N/A	N/A	N/A	N/A	N/A
0.3±0.05			N/A	N/A	N/A	N/A	N/A	N/A	N/A	N/A	N/A	N/A	N/A
0.4±0.05			N/A	N/A	N/A	N/A	N/A	N/A	N/A	N/A	N/A	N/A	N/A
0.5±0.05			N/A	N/A	N/A	N/A	N/A	N/A	N/A	N/A	N/A	N/A	N/A
0.6±0.10			N/A	N/A	N/A	N/A	N/A	N/A	N/A	N/A	N/A	N/A	N/A
0.7±0.10			N/A	N/A	N/A	N/A	N/A	N/A	N/A	N/A	N/A	N/A	N/A
0.8±0.10			N/A	N/A	N/A	N/A	N/A	N/A	N/A	N/A	N/A	N/A	N/A
0.9±0.10			N/A	N/A	N/A	N/A	N/A	N/A	N/A	N/A	N/A	N/A	N/A
1.0±0.10	5.6	250	1.20/0.90	.320	500	1.20/0.90	.300	750	1.20/0.90	.270	999	1.20/0.90	.300
1.1±0.10	5.4	248	1.30/1.00	.290	496	1.30/1.00	.270	754	1.30/1.00	.250	993	1.30/1.00	.290
1.2±0.10	5.1	245	1.40/1.10	.270	492	1.40/1.10	.250	739	1.40/1.10	.240	987	1.40/1.10	.280
1.3±0.10	4.9	243	1.50/1.20	.260	488	1.50/1.20	.230	734	1.50/1.10	.230	980	1.50/1.10	.270
1.4±0.10	4.8	242	1.60/1.30	.240	487	1.60/1.20	.220	733	1.60/1.20	.220	979	1.60/1.20	.260
1.5±0.10	4.6	242	1.70/1.40	.230	486	1.70/1.40	.210	731	1.70/1.40	.220	977	1.70/1.40	.260
1.6±0.10	4.5	241	1.80/1.50	.220	484	1.85/1.50	.210	729	2.00/1.50	.220	975	2.00/1.50	.250
1.7±0.10	4.3	240	1.90/1.60	.210	483	1.95/1.60	.200	728	2.05/1.60	.210	974	2.20/1.60	.240
1.8±0.10	4.2	239	2.00/1.70	.200	482	2.05/1.70	.190	726	2.10/1.70	.210	972	2.30/1.70	.230
1.9±0.10	4.1	239	2.10/1.80	.200	481	2.15/1.80	.190	724	2.25/1.80	.200	970	2.40/1.80	.230
2.0±0.10	4.0	238	2.20/1.90	.190	479	2.30/1.90	.180	722	2.40/1.90	.200	967	2.60/1.95	.220
2.1±0.10	3.9	237	2.30/2.00	.190	477	2.40/2.00	.170	720	2.60/2.00	.190	964	2.80/2.06	.210
2.2±0.10	3.8	236	2.40/2.10	.180	475	2.60/2.10	.170	716	2.80/2.14	.190	962	3.06/2.17	.210
2.4±0.25	3.6	235	2.85/2.15	.170	473	3.13/2.29	.170	714	3.17/2.30	.190	960	3.31/2.31	.210
2.7±0.25	3.4	233	3.19/2.45	.160	470	3.47/2.55	.150	711	3.52/2.60	.170	957	3.67/2.60	.200
3.0±0.25	3.3	231	3.51/2.75	.150	465	3.76/2.86	.140	707	3.84/2.93	.160	952	4.00/3.00	.190
3.3±0.25	3.1	229	3.83/3.05	.140	463	4.04/3.10	.140	704	4.15/3.19	.160	948	4.38/3.30	.190
3.6±0.25	3.0	228	4.16/3.35	.140	462	4.35/3.42	.130	704	4.50/3.53	.150	947	4.80/3.60	.190
3.9±0.25	2.9	227	4.48/3.65	.130	459	4.67/3.72	.120	701	4.85/3.86	.150	944	5.23/3.90	.180
4.3±0.25	2.7	223	4.91/4.05	.130	456	5.11/4.13	.120	697	5.32/4.25	.150	940	5.79/4.50	.180
4.7±0.25	2.6	220	5.35/4.45	.120	451	5.52/4.53	.110	691	5.79/4.60	.140	936	6.36/4.80	.170
5.1±0.25	2.5	218	5.78/4.85	.120	447	5.94/4.94	.110	688	6.25/5.20	.140	934	7.16/5.74	.160
5.6±0.25	2.4	215	6.00/5.35	.100	444	6.82/5.40	.100	684	7.27/5.60	.120	930	8.25/5.90	.150
6.2±0.25	2.3	212	7.00/5.95	.100	442	7.52/6.00	.100	683	8.08/6.10	.120	927	9.35/6.80	.150
6.8±0.25	2.2	208	7.20/6.55	.100	435	8.21/6.88	.100	677	8.90/6.96	.120	925	10.46/7.32	.150
7.5±0.05	2.1	206	8.64/7.00	.100	434	9.02/7.10	.100	675	9.85/7.50	.120	924	11.75/8.42	.150
8.2±0.05	2.0	203	9.40/7.70	.090	432	9.83/7.90	.080	673	10.80/8.25	.110	922	13.04/9.53	.150
9.1±0.05	1.9	199	10.37/8.60	.080	429	10.88/8.76	.080	670	12.02/9.10	.110	920	14.70/10.70	.150
10±5%	1.8	196	11.00/9.50	.080	423	11.92/9.76	.080	668	13.24/10.00	.110	918	15.37/11.80	.140
11±5%	1.8	193	12.50/10.45	.080	420	13.23/10.50	.080	665	15.07/11.00	.110	916	16.00/12.20	.140
12±5%	1.6	190	13.61/11.40	.070	418	14.50/11.90	.080	663	16.90/12.82	.110	915	N/A	.140
13±5%	1.6	187	14.75/12.35	.070	416	15.80/13.00	.080	662	18.87/14.00	.110	914	N/A	.140
14±5%	1.5	184	15.88/13.30	.070	414	17.22/14.00	.080	661	20.84/16.00	.110	913	N/A	.140
15±5%	1.5	182	17.02/14.25	.070	414	18.56/15.19	.080	660	22.62/19.13	.110	912	N/A	.130
16±5%	1.4	179	18.16/15.20	.070	411	19.90/16.28	.080	659	27.00/20.89	.100	911	N/A	.130
18±5%	1.3	176	20.42/17.10	.070	408	22.69/18.57	.070	657	33.00/22.10	.100	910	N/A	.130
20±5%	1.3	173	22.70/19.00	.060	406	25.38/20.78	.070	656	38.00/23.15	.100	908	N/A	.130
22±5%	1.2	171	24.95/20.90	.060	405	28.08/21.00	.070	655	42.00/24.00	.100	907	N/A	.130
24±5%	1.2	168	27.20/22.80	.060	403	31.31/25.61	.070	654	N/A	.090	907	N/A	.130
27±5%	1.1	165	30.78/25.69	.060	401	36.10/32.20	.070	652	N/A	.090	906	N/A	.130
30±5%	1.0	163	34.23/28.50	.050	400	40.58/33.20	.070	651	N/A	.090	905	N/A	.130
33±5%	1.0	159	37.85/31.35	.050	399	46.65/35.00	.070	650	N/A	.090	904	N/A	.120
36±5%	0.9	157	41.19/34.20	.050	397	52.22/38.00	.070	649	N/A	.090	903	N/A	.120
39±5%	0.9	155	44.79/37.05	.050	396	59.08/47.08	.070	648	N/A	.090	902	N/A	.120
43±5%	0.9	153	49.99/40.85	.050	395	70.50/53.04	.060	647	N/A	.090	901	N/A	.120
47±5%	0.8	152	55.19/44.65	.050	394	81.99/59.00	.060	646	N/A	.090	900	N/A	.110

* Other tolerances are available, see page 8



1210 Typical Electrical Tables

1

Capacitance & Tolerance* @ 1 MHz (pF)	Self Resonance Frequency (GHz)	Ref Freq. (MHz)	Effective Capacitance Max/Min (pF)	Max ESR (Ω)	Ref Freq. (MHz)	Effective Capacitance Max/Min (pF)	Max ESR (Ω)	Ref Freq. (MHz)	Effective Capacitance Max/Min (pF)	Max ESR (Ω)	Ref Freq. (MHz)	Effective Capacitance Max/Min (pF)	Max ESR (Ω)
1.0±0.25	4.98	247	1.23/0.75	.350	495	1.34/0.86	.260	745	1.46/0.94	.280	995	1.6/0.99	.350
1.2±0.25	4.55	245	1.32/0.95	.310	491	1.45/1.00	.240	739	1.64/1.1	.260	987	2.00/1.2	.320
1.5±0.25	4.07	242	1.6/1.23	.250	486	1.75/1.3	.230	731	1.82/1.95	.250	978	2.1/1.4	.270
1.8±0.25	9.71	240	2.1/1.55	.200	482	2.21/1.56	.200	731	2.4/1.6	.200	978	2.54/1.7	.210
2.2±0.25	9.96	237	2.48/1.95	.170	476	2.68/2.00	.170	727	2.85/2.1	.180	969	3.02/2.2	.200
2.7±0.25	2.70	233	3.42/2.45	.140	466	3.49/2.55	.140	708	3.73/2.63	.150	952	3.89/2.70	.170
3.3±0.25	2.60	229	4.02/3.05	.140	463	4.09/3.15	.130	704	4.33/3.23	.140	948	4.49/3.30	.160
3.6±0.25	2.50	228	4.18/3.35	.130	462	4.32/3.43	.130	704	4.50/3.32	.140	947	4.78/3.45	.160
3.9±0.25	2.40	227	4.53/3.65	.130	458	4.66/3.73	.120	701	4.85/3.75	.140	944	5.18/3.90	.150
4.3±0.25	2.30	223	5.01/4.05	.120	456	5.11/4.14	.110	697	5.32/4.29	.130	940	5.72/4.30	.140
4.7±0.25	2.20	220	5.48/4.45	.120	451	5.62/4.50	.110	691	5.94/4.60	.130	936	6.56/4.70	.140
5.1±0.25	2.10	218	5.88/4.85	.110	447	6.04/4.90	.110	683	6.36/5.10	.130	933	7.20/5.40	.140
5.6±0.25	2.00	215	6.49/5.35	.110	441	6.72/5.56	.100	681	7.17/5.67	.120	928	8.15/6.00	.140
6.2±0.25	1.90	212	7.19/5.95	.100	442	7.26/6.07	.100	679	7.99/6.10	.110	927	9.18/7.00	.130
6.8±0.25	1.80	208	7.38/6.55	.100	435	8.16/6.42	.100	677	8.81/6.93	.110	925	10.20/7.42	.130
7.5±0.25	1.70	206	8.60/7.90	.100	434	8.90/7.25	.100	675	9.58/7.60	.100	924	11.36/8.00	.130
8.2±0.25	1.70	203	9.36/7.70	.100	432	9.76/7.96	.090	673	10.68/8.31	.100	922	13.00/9.10	.130
9.1±0.25	1.60	199	10.34/8.60	.090	429	10.87/8.88	.090	670	12.10/9.66	.090	920	15.11/10.25	.130
10±5%	1.50	196	11.33/9.50	.090	423	11.97/9.79	.090	668	13.51/10.05	.090	918	17.22/11.06	.130
11±5%	1.50	193	12.50/10.45	.090	420	13.23/10.83	.090	665	15.07/11.33	.090	916	N/A	.130
12±5%	1.40	190	13.61/11.40	.080	418	14.59/11.90	.080	663	16.90/12.82	.090	915	N/A	.120
13±5%	1.30	185	14.75/12.35	.080	416	15.64/13.00	.080	662	18.80/13.60	.090	914	N/A	.120
14±5%	1.30	183	15.89/13.30	.080	415	17.22/14.00	.080	661	20.85/16.00	.090	913	N/A	.120
15±5%	1.20	182	17.02/14.25	.080	414	18.56/15.19	.080	660	22.62/17.00	.090	912	N/A	.110
16±5%	1.20	180	18.16/15.20	.080	411	19.90/16.28	.080	659	25.12/18.00	.090	911	N/A	.110
18±5%	1.10	176	20.42/17.10	.070	408	22.69/18.57	.080	657	30.00/24.00	.080	909	N/A	.110
20±5%	1.10	173	22.70/19.00	.070	406	25.36/20.78	.080	656	35.00/26.00	.080	908	N/A	.110
22±5%	1.00	171	24.95/20.90	.070	405	28.06/22.96	.080	655	42.00/27.00	.080	908	N/A	.110
24±5%	0.98	168	27.20/22.60	.070	403	31.31/25.60	.080	654	N/A	.080	907	N/A	.110
25±5%	0.96	166	26.39/23.75	.070	402	32.91/26.00	.080	653	N/A	.080	907	N/A	.110
27±5%	0.92	164	30.78/25.65	.070	401	36.10/28.00	.070	652	N/A	.080	906	N/A	.110
28±5%	0.91	163	31.93/26.50	.070	401	37.60/30.76	.070	651	N/A	.080	906	N/A	.110
30±5%	0.88	162	34.23/28.50	.070	400	40.50/33.20	.070	651	N/A	.080	905	N/A	.110
32±5%	0.85	161	36.51/30.40	.070	399	44.63/34.50	.070	650	N/A	.080	905	N/A	.110
33±5%	0.84	159	37.65/31.35	.060	399	46.65/35.00	.070	650	N/A	.080	905	N/A	.110
34±5%	0.82	158	38.83/32.30	.060	398	48.51/37.00	.070	649	N/A	.080	904	N/A	.110
36±5%	0.80	157	41.20/34.20	.060	397	52.22/41.00	.070	649	N/A	.070	904	N/A	.110
39±5%	0.77	155	44.79/37.05	.060	396	59.00/43.00	.070	649	N/A	.070	904	N/A	.110
43±5%	0.73	153	49.99/40.85	.060	396	70.00/46.00	.070	648	N/A	.070	904	N/A	.110
47±5%	0.70	152	55.69/44.65	.060	395	81.00/53.00	.070	648	N/A	.070	903	N/A	.110

* Other tolerances are available, see page 8

High Frequency Characteristics

1

Typical ESR vs. Frequency
Accu-P® 0201

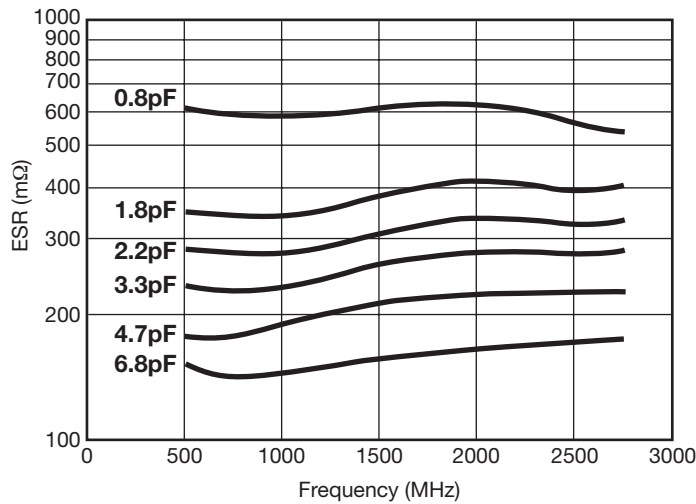

Typical SRF vs. Capacitance
Accu-P® 0201

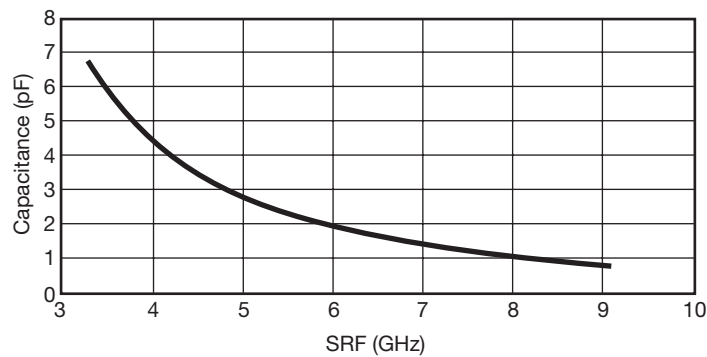

Typical Q vs. Frequency
Accu-P® 0201

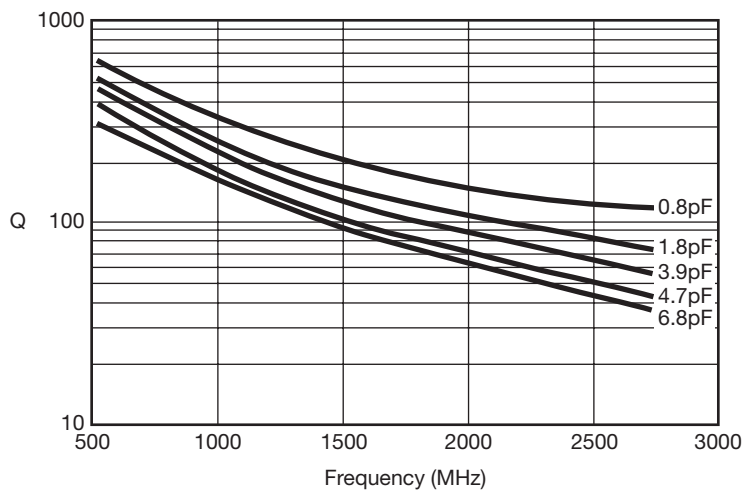

Accu-F[®] / Accu-P[®]

High Frequency Characteristics



1

Typical ESR vs. Frequency
Accu-P[®] 0402

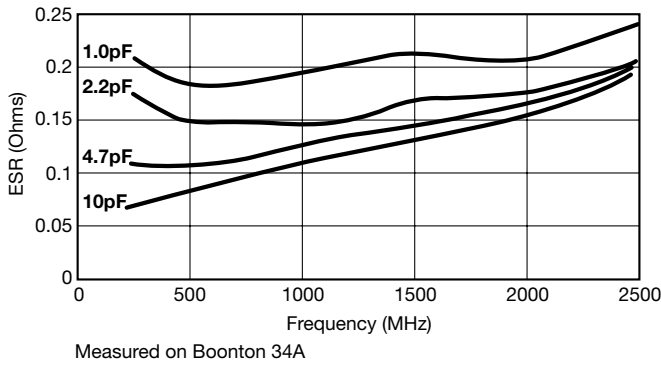

Typical ESR vs. Frequency
Accu-F[®]/Accu-P[®] 0603

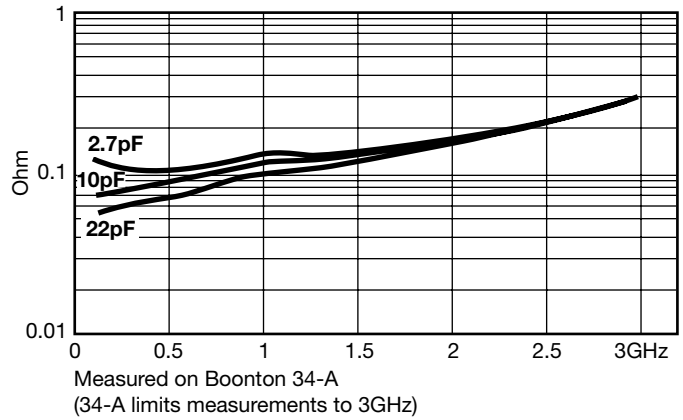

Typical Q vs. Frequency
Accu-P[®] 0402

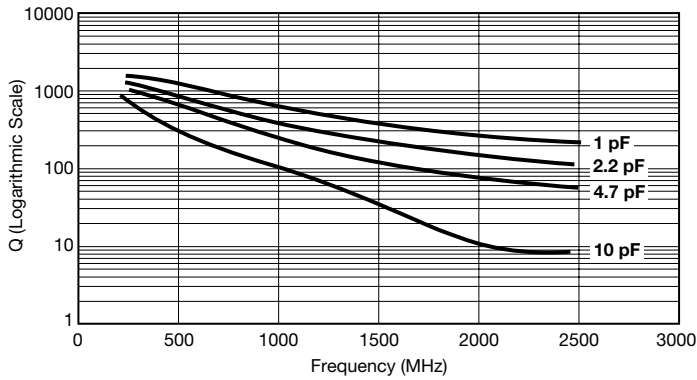

Typical Q vs. Frequency
Accu-F[®]/Accu-P[®] 0603

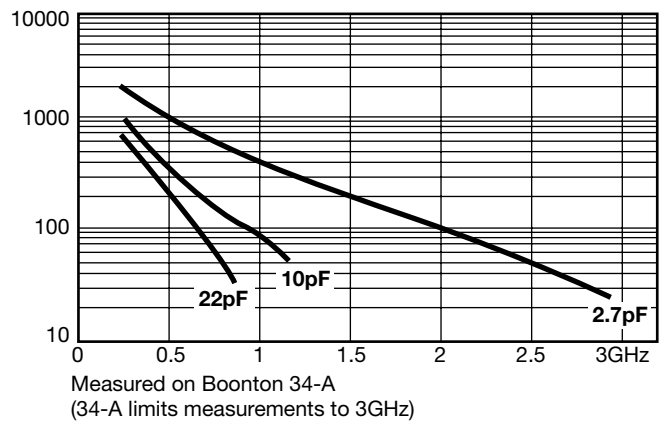

Typical Self Resonant Frequency vs. Capacitance
Accu-P[®] 0402

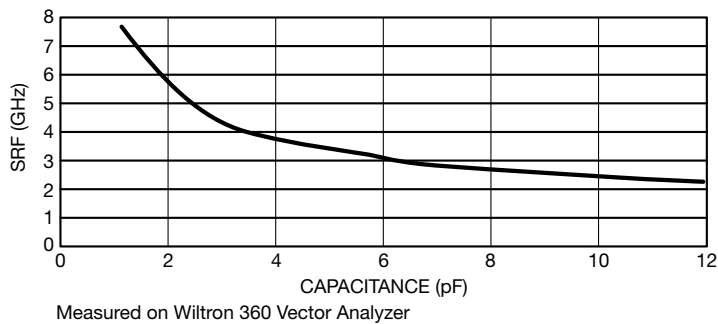

Typical Self Resonant Frequency vs. Capacitance
Accu-F[®]/Accu-P[®] 0603

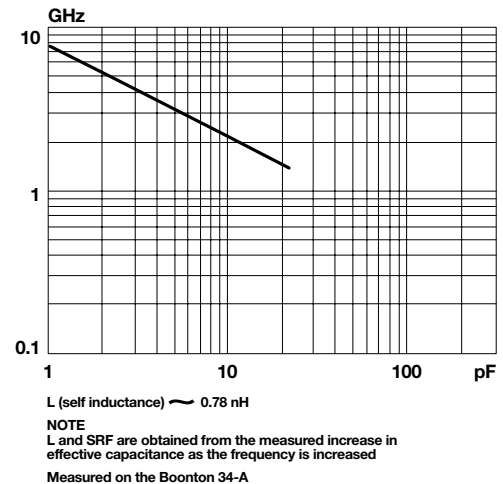

Accu-F® / Accu-P®

High Frequency Characteristics



1

Typical ESR vs. Frequency
Accu-F®/Accu-P® 0805

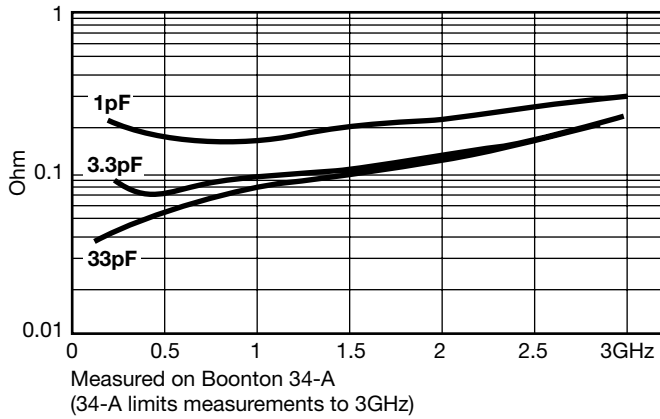

Typical ESR vs. Frequency
Accu-P® 1210

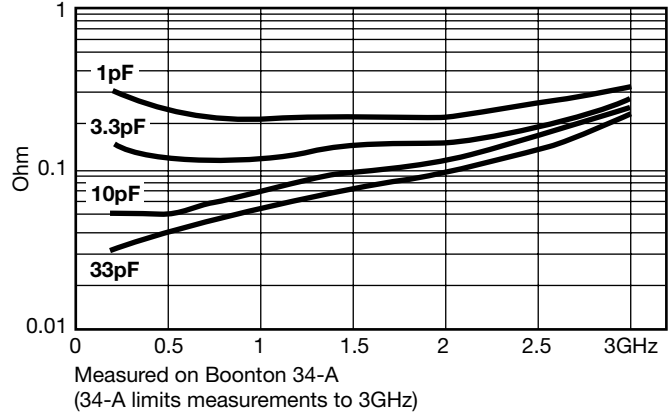

Typical Q vs. Frequency
Accu-F®/Accu-P® 0805

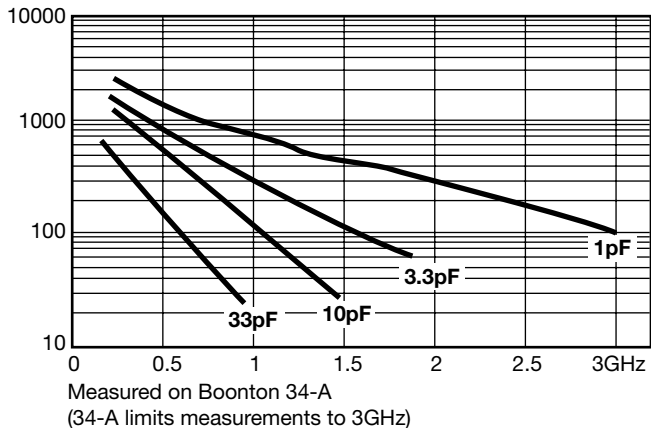

Typical Q vs. Frequency
Accu-P® 1210

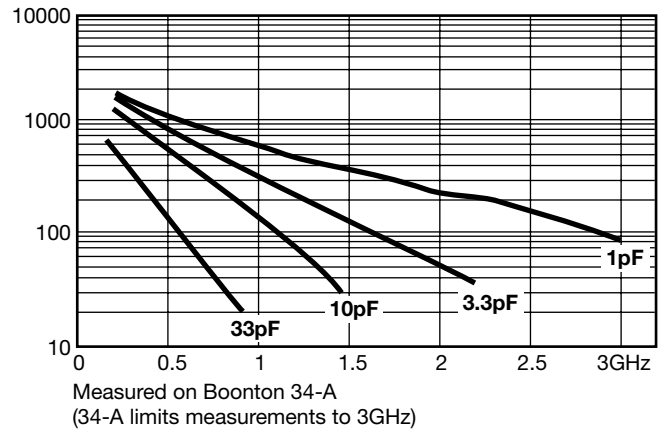

Typical Self Resonant Frequency vs. Capacitance
Accu-F®/Accu-P® 0805

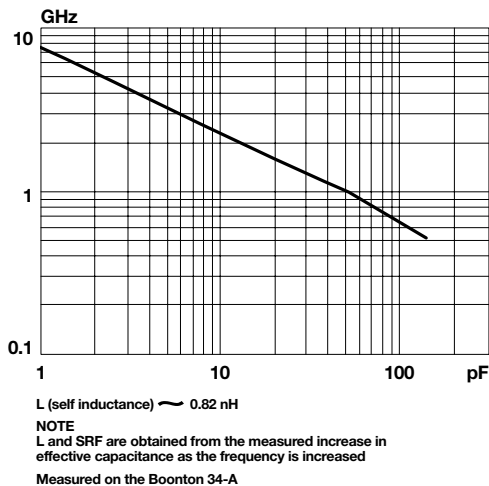

Typical Self Resonant Frequency vs. Capacitance
Accu-P® 1210

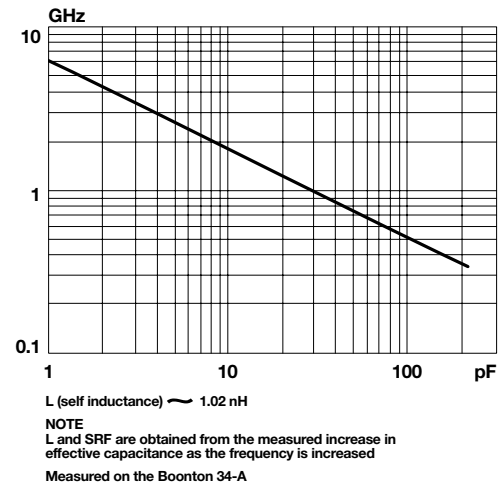

Environmental / Mechanical Characteristics

ENVIRONMENTAL CHARACTERISTICS

TEST	CONDITIONS	REQUIREMENT
Life (Endurance) MIL-STD-202F Method 108A	125°C, 2U _R , 1000 hours	No visible damage $\Delta C/C \leq 2\%$ for C \geq 5pF $\Delta C \leq 0.25\text{pF}$ for C<5pF
Accelerated Damp Heat Steady State MIL-STD-202F Method 103B	85°C, 85% RH, U _R , 1000 hours	No visible damage $\Delta C/C \leq 2\%$ for C \geq 5pF $\Delta C \leq 0.25\text{pF}$ for C<5pF
Temperature Cycling MIL-STD-202F Method 107E MIL-STD-883D Method 1010.7	-55°C to +125°C, 15 cycles – Accu-P® -55°C to +125°C, 5 cycles – Accu-F®	No visible damage $\Delta C/C \leq 2\%$ for C \geq 5pF $\Delta C \leq 0.25\text{pF}$ for C<5pF
Resistance to Solder Heat IEC-68-2-58	260°C \pm 5°C for 10 secs	C remains within initial limits

MECHANICAL CHARACTERISTICS

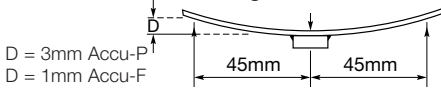
TEST	CONDITIONS	REQUIREMENT
Solderability IEC-68-2-58	Components completely immersed in a solder bath at 235°C for 2 secs.	Terminations to be well tinned, minimum 95% coverage
Leach Resistance IEC-68-2-58	Components completely immersed in a solder bath at 260 \pm 5°C for 60 secs.	Dissolution of termination faces \leq 15% of area Dissolution of termination edges \leq 25% of length
Adhesion MIL-STD-202F Method 211A	A force of 5N applied for 10 secs.	No visible damage
Termination Bond Strength IEC-68-2-21 Amend. 2	Tested as shown in diagram  D = 3mm Accu-P D = 1mm Accu-F	No visible damage $\Delta C/C \leq 2\%$ for C \geq 5pF $\Delta C \leq 0.25\text{pF}$ for C<5pF
Robustness of Termination IEC-68-2-21 Amend. 2	A force of 5N applied for 10 secs.	No visible damage
High Frequency Vibration MIL-STD-202F Method 201A, 204D (Accu-P® only)	55Hz to 2000Hz, 20G	No visible damage
Storage	12 months minimum with components stored in "as received" packaging	Good solderability

QUALITY & RELIABILITY

Accu-P® is based on well established thin-film technology and materials.

• ON-LINE PROCESS CONTROL

This program forms an integral part of the production cycle and acts as a feedback system to regulate and control production processes. The test procedures, which are integrated into the production process, were developed after long research work and are based on the highly developed semiconductor industry test procedures and equipment. These measures help AVX to produce a consistent and high yield line of products.

• FINAL QUALITY INSPECTION

Finished parts are tested for standard electrical parameters and visual/mechanical characteristics. Each production lot is 100% evaluated for: capacitance and proof voltage at 2.5 U_R. In addition, production is periodically evaluated for:

- Average capacitance with histogram printout for capacitance distribution;
- IR and Breakdown Voltage distribution;
- Temperature Coefficient;
- Solderability;
- Dimensional, mechanical and temperature stability.

QUALITY ASSURANCE

The reliability of these thin-film chip capacitors has been studied intensively for several years. Various measures have been taken to obtain the high reliability required today by the industry. Quality assurance policy is based on well established international industry standards. The reliability of the capacitors is determined by accelerated testing under the following conditions:

Life (Endurance)	125°C, 2U _R , 1000 hours
Accelerated Damp Heat Steady State	85°C, 85% RH, U _R , 1000 hours.

Performance Characteristics RF Power Applications

RF POWER APPLICATIONS

In RF power applications capacitor losses generate heat. Two factors of particular importance to designers are:

- Minimizing the generation of heat.
- Dissipating heat as efficiently as possible.

CAPACITOR HEATING

- The major source of heat generation in a capacitor in RF power applications is a function of RF current (I) and ESR, from the relationship:

$$\text{Power dissipation} = I_{\text{RMS}}^2 \times \text{ESR}$$

- Accu-P® capacitors are specially designed to minimize

ESR and therefore RF heating. Values of ESR for Accu-P® capacitors are significantly less than those of ceramic MLC components currently available.

HEAT DISSIPATION

- Heat is dissipated from a capacitor through a variety of paths, but the key factor in the removal of heat is the thermal conductivity of the capacitor material.
- The higher the thermal conductivity of the capacitor, the more rapidly heat will be dissipated.
- The table below illustrates the importance of thermal conductivity to the performance of Accu-P® in power applications.



PRODUCT	MATERIAL	THERMAL CONDUCTIVITY W/mK
Accu-P® Microwave MLC	Alumina Magnesium Titanate	18.9 6.0

**Power Handling
Accu-P® 10pF**

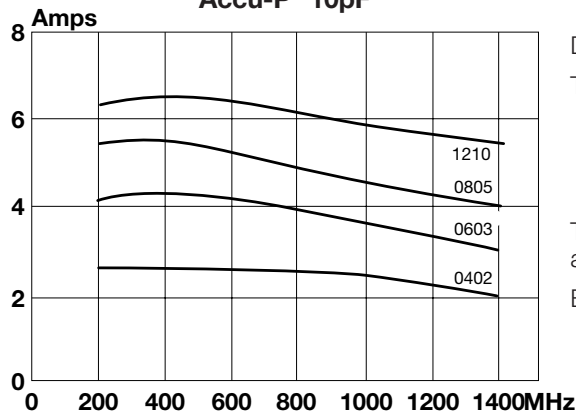

Data used in calculating the graph:

Thermal impedance of capacitors:

0402	17°C/W
0603	12°C/W
0805	6.5°C/W
1210	5°C/W

Thermal impedance measured using RF generator, amplifier and strip-line transformer.

ESR of capacitors measured on Boonton 34A

THERMAL IMPEDANCE

Thermal impedance of Accu-P® chips is shown below compared with the thermal impedance of Microwave MLC's.

CAPACITOR TYPE	CHIP SIZE	THERMAL IMPEDANCE (°C/W)
Accu-P®	0805	6.5
	1210	5
Microwave MLC	0505	12
	1210	7.5

The thermal impedance expresses the temperature difference in °C between chip center and termination caused by a power dissipation of 1 watt in the chip. It is expressed in °C/W.

ADVANTAGES OF ACCU-P® IN RF POWER CIRCUITS

The optimized design of Accu-P® offers the designer of RF power circuits the following advantages:

- Reduced power losses due to the inherently low ESR of Accu-P®.
- Increased power dissipation due to the high thermal conductivity of Accu-P®.

• THE ONLY TRUE TEST OF A CAPACITOR IN ANY PARTICULAR APPLICATION IS ITS PERFORMANCE UNDER OPERATING CONDITIONS IN THE ACTUAL CIRCUIT.

PRACTICAL APPLICATION IN RF POWER CIRCUITS

- There is a wide variety of different experimental methods for measuring the power handling performance of a capacitor in RF power circuits. Each method has its own problems and few of them exactly reproduce the conditions present in "real" circuit applications.
- Similarly, there is a very wide range of different circuit applications, all with their unique characteristics and operating conditions which cannot possibly be covered by such "theoretical" testing.

Application Notes

GENERAL

Accu-F® and Accu-P® SMD capacitors are designed for soldering to printed circuit boards or other substrates. The construction of the components is such that they will withstand the time/temperature profiles used in both wave and reflow soldering methods.

1

CIRCUIT BOARD TYPE

The circuit board types which may be used with Accu-F® and Accu-P® are as follows:

- Accu-F®: All flexible types of circuit boards (eg. FR-4, G-10).
- Accu-P®: All flexible types of circuit boards (eg. FR-4, G-10) and also alumina.

For other circuit board materials, please consult factory.

HANDLING

SMD capacitors should be handled with care to avoid damage or contamination from perspiration and skin oils. The use of plastic tipped tweezers or vacuum pick-ups is strongly recommended for individual components. Bulk handling should ensure that abrasion and mechanical shock are minimized. For automatic equipment, taped and reeled product gives the ideal medium for direct presentation to the placement machine.

COMPONENT PAD DESIGN

Component pads must be designed to achieve good joints and minimize component movement during reflow soldering. Pad designs are given below for both wave and reflow soldering.

The basis of these designs is:

- Pad width equal to component width. It is permissible to decrease this to as low as 85% of component width but it is not advisable to go below this.
- Pad overlap 0.5mm beneath large components. Pad overlap about 0.3mm beneath small components.
- Pad extension of 0.5mm for reflow of large components and pad extension about 0.3mm for reflow of small components. Pad extension about 1.0mm for wave soldering.

WAVE SOLDERING

DIMENSIONS: millimeters (inches)

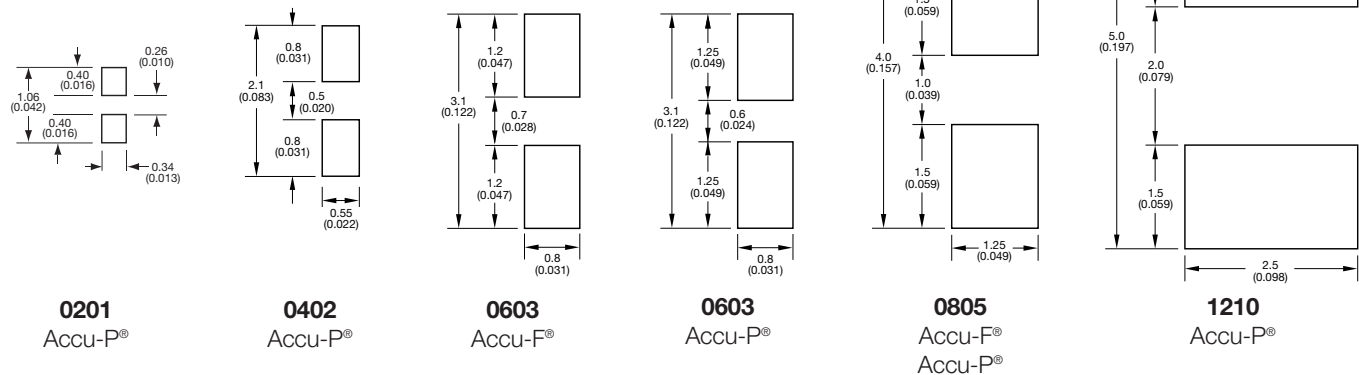

REFLOW SOLDERING

DIMENSIONS: millimeters (inches)

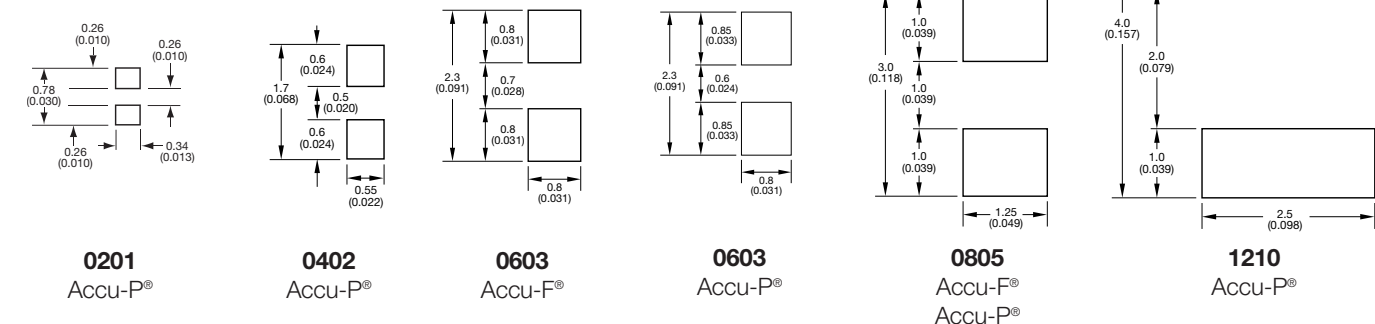

Application Notes

PREHEAT & SOLDERING

The rate of preheat in production should not exceed 4°C/second and a recommended maximum is about 2°C/second. Temperature differential from preheat to soldering should not exceed 100°C.

For further specific application or process advice, please consult AVX.

COOLING

After soldering, the assembly should preferably be allowed to cool naturally. In the event of assisted cooling, similar conditions to those recommended for preheating should be used.

HAND SOLDERING & REWORK

Hand soldering is permissible. Preheat of the PCB to 150°C is required. The most preferable technique is to use hot air soldering tools. Where a soldering iron is used, a temperature controlled model not exceeding 30 watts should be used and set to not more than 260°C.

RECOMMENDED SOLDERING PROFILE

IR REFLOW

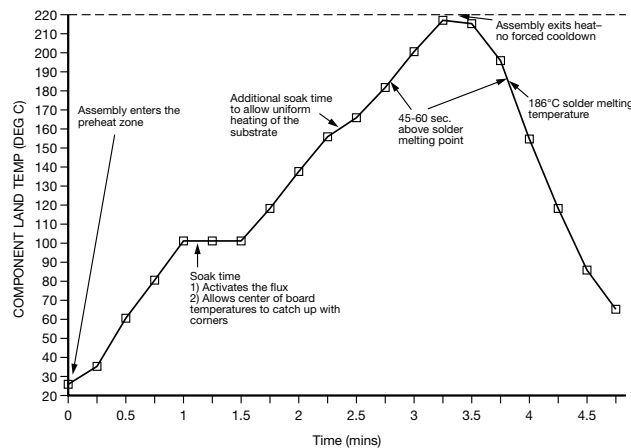

VAPOR PHASE

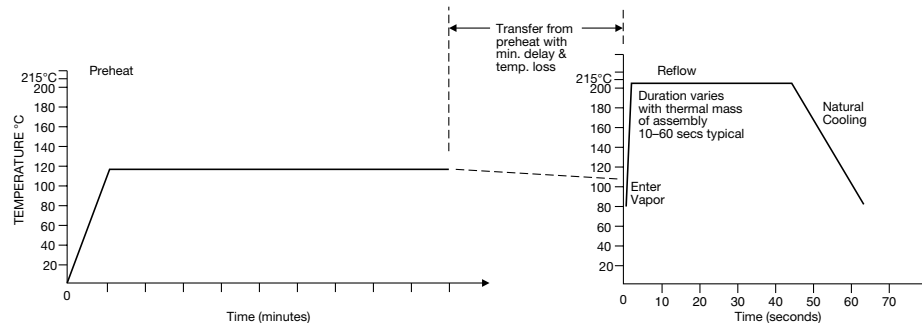

CLEANING RECOMMENDATIONS

Care should be taken to ensure that the devices are thoroughly cleaned of flux residues, especially the space beneath the device. Such residues may otherwise become conductive and effectively offer a lossy bypass to the device. Various recommended cleaning conditions (which must be optimized for the flux system being used) are as follows:

Cleaning liquids. i-propanol, ethanol, acetylacetone, water and other standard PCB cleaning liquids.

Ultrasonic conditions . . power-20w/liter max. frequency-20kHz to 45kHz.

Temperature 80°C maximum (if not otherwise limited by chosen solvent system).

Time 5 minutes max.

STORAGE CONDITIONS

Recommended storage conditions for Accu-F® and Accu-P® prior to use are as follows:

Temperature 15°C to 35°C

Humidity ≤65%

Air Pressure 860mbar to 1060mbar

WAVE SOLDERING

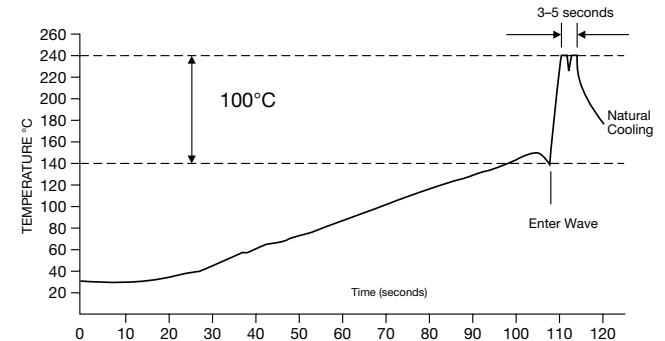

Automatic Insertion Packaging

TAPE & REEL

All tape and reel specifications are in compliance with EIA 481-1-A.
(equivalent to IEC 286 part 3).

- 8mm carrier
- Reeled quantities: Reels of 3,000 per 7" reel or 10,000 pieces per 13" reel
0201 and 0402 = 5,000 pieces per 7" reel and 20,000 pieces per 13" reel

1

REEL

DIMENSIONS: millimeters (inches)

A ⁽¹⁾	B	C	D	E	F	G
180±1.0 (7.087±0.039)	1.5 min. (0.059 min.)	13±0.2 (0.512 ± 0.008)	20.2 min. (0.795 min.)	50 min. (1.969 min.)	9.6±1.5 (0.370 ± 0.050)	14.4 max. (0.567 max.)

Metric dimensions will govern.
Inch measurements rounded and for reference only.

(1) 330mm (13 inch) reels are available.

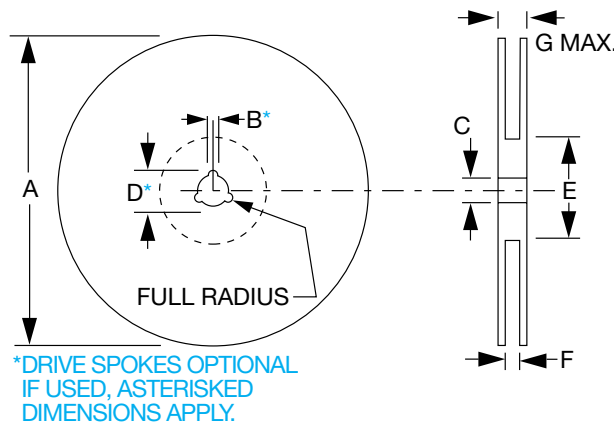

CARRIER

DIMENSIONS: millimeters (inches)

A	B	C	D	E	F
8.0 ± 0.3 (0.315 ± 0.012)	3.5 ± 0.05 (0.138 ± 0.002)	1.75±0.1 (0.069 ± 0.004)	2.0 ± 0.05 (0.079 ± 0.002)	4.0 ± 0.1 (0.157 ± 0.004)	1.5 ^{+0.1} _{-0.0} (0.059 ^{+0.004} _{-0.000})

NOTE: The nominal dimensions of the component compartment (W,L) are derived from the component size.

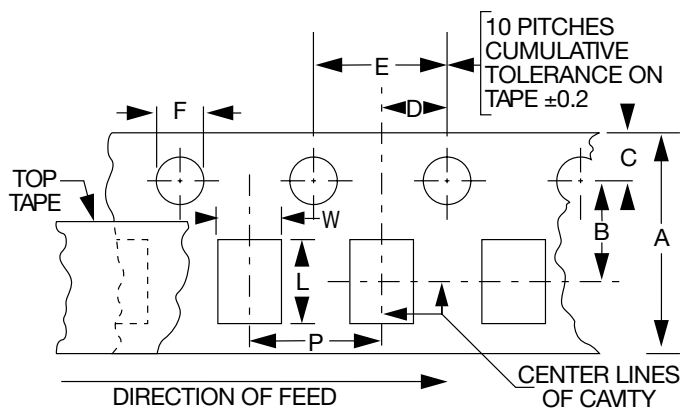

P = 4mm except 0201 and 0402 where P = 2mm

NOTE: AVX reserves the right to change the information published herein without notice.



Thin-Film Technology

2

Accu-L[®] L0603/L0805

Thin-Film RF/Microwave Inductors



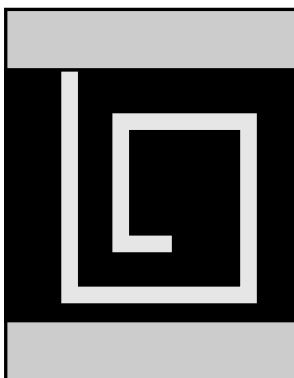

10 nH Inductor (Top View)

ACCU-L[®] TECHNOLOGY

The Accu-L[®] SMD Inductor is based on thin-film multilayer technology. This technology provides a level of control on the electrical and physical characteristics of the component which gives consistent characteristics within a lot and lot-to-lot.

The original design provides small size, excellent high-frequency performance and rugged construction for reliable automatic assembly.

The Accu-L[®] inductor is particularly suited for the telecommunications industry where there is a continuing trend towards miniaturization and increasing frequencies. The Accu-L[®] inductor meets both the performance and tolerance requirements of present cellular frequencies 450MHz and 900MHz and of future frequencies, such as 1700MHz, 1900MHz and 2400MHz.

FEATURES

- High Q
- RF Power Capability
- High SRF
- Low DC Resistance
- Ultra-Tight Tolerance on Inductance
- Standard 0603 and 0805 Chip Size
- Low Profile
- Rugged Construction
- Taped and Reeled

APPLICATIONS

- Mobile Communications
- Satellite TV Receivers
- GPS
- Vehicle Locations Systems
- Filters
- Matching Networks

Accu-L[®] 0603 and 0805



SMD High-Q RF Inductor

DIMENSIONS: millimeters (inches)

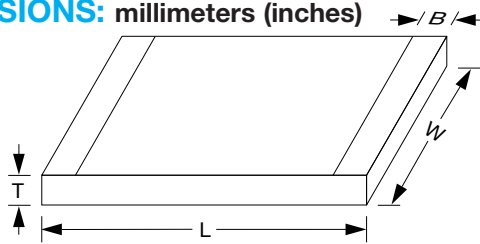

	0603	0805
L	1.6±0.10 (0.063±0.004)	2.11±0.10 (0.083±0.004)
W	0.81±0.10 (0.032±0.004)	1.5±0.10 (0.059±0.004)
T	0.61±0.10 (0.024±0.004)	0.91±0.13 (0.036±0.005)
B	top: 0.0 +0.3/-0.0 (0.0+0.012) bottom: 0.35±0.20 (0.014±0.008)	0.25±0.15 (0.010±0.006)

Operating/Storage
Temp. Range:
-55°C to +125°C

HOW TO ORDER

L	0805	4R7	D	E	W	TR
Product Inductor	Size 0603 0805	Inductance Expressed in nH (2 significant digits + number of zeros) for values <10nH, letter R denotes decimal point. Example: 22nH = 220 4.7nH = 4R7	Tolerance for L ≤ 4.7nH, B = ±0.1nH C = ±0.2nH D = ±0.5nH 4.7nH < L < 10nH, C = ±0.2nH D = ±0.5nH	Specification Code E = Accu-L [®] 0805 technology G = Accu-L [®] 0603 technology	Termination Code W = Nickel/ solder coated (Sn 63, Pb 37)	Packaging Code TR = Tape and Reel (3,000/reel)

2

ELECTRICAL SPECIFICATIONS TABLE FOR ACCU-L[®] 0603

450 MHz Test Frequency			900 MHz Test Frequency		1900 MHz Test Frequency		2400 MHz Test Frequency		SRF min (MHz)	R _{DC} max (Ω)	I _{DC} max (mA)
Inductance L (nH)	Available Inductance Tolerance	Q Typical	L (nH)	Q Typical	L (nH)	Q Typical	L (nH)	Q Typical			
1.2	±0.1, ±0.2nH	49	1.2	70	1.2	134	1.2	170	10000	0.04	1000
1.5	±0.1, ±0.2nH	26	1.54	39	1.52	63	1.52	76	10000	0.06	1000
1.8	±0.1, ±0.2nH	20	1.74	30	1.73	50	1.72	59	10000	0.07	1000
2.2	±0.1, ±0.2nH	20	2.2	30	2.24	49	2.24	56	10000	0.08	1000
2.7	±0.1, ±0.2nH	21	2.7	30	2.75	48	2.79	54	9000	0.08	750
3.3	±0.1, ±0.2, ±0.5nH	24	3.33	35	3.39	56	3.47	64	8400	0.08	750
3.9	±0.1, ±0.2, ±0.5nH	25	3.9	57	4.06	60	4.21	69	6500	0.12	500
4.7	±0.1, ±0.2, ±0.5nH	23	4.68	32	4.92	46	5.2	49	5500	0.15	500
5.6	±0.2, ±0.5nH	26	5.65	36	5.94	54	6.23	60	5000	0.25	300
6.8	±0.2, ±0.5nH	23	6.9	33	7.3	47	8.1	39	4500	0.30	300
8.2	±0.2, ±0.5nH	23	8.4	31	10	35	12.1	31	3800	0.35	300
10.0	±2%, ±5%	28	10	39	11.8	47	14.1	41	3500	0.45	300
12.0	±2%, ±5%	28	13.2	38	14.1	30	17.2	20	3000	0.50	300
15.0	±2%, ±5%	28	16.2	38	25.9	30	49.8	15	2500	0.60	300

(1) I_{DC} measured for 15°C rise at 25°C ambient temperature when soldered to FR-4 board.

Inductance and Q measured on Agilent 4291B / 4287 using the 16196A test fixture.

ELECTRICAL SPECIFICATIONS TABLE FOR ACCU-L[®] 0805

450 MHz Test Frequency			900 MHz Test Frequency		1700 MHz Test Frequency		2400 MHz Test Frequency		SRF min (MHz)	R _{DC} max (Ω)	I _{DC} max (mA)	
Inductance L (nH)	Available Inductance Tolerance	Q Typical	L (nH)	Q Typical	L (nH)	Q Typical	L (nH)	Q Typical			ΔT = 15°C (1)	ΔT = 70°C (2)
1.2	±0.1nH, ±0.2nH, ±0.5nH	60	1.2	92	1.2	122	1.2	92	10000	0.05	1000	2000
1.5	±0.1nH, ±0.2nH, ±0.5nH	50	1.5	74	1.5	102	1.5	84	10000	0.05	1000	2000
1.8	±0.1nH, ±0.2nH, ±0.5nH	50	1.8	72	1.8	88	1.9	73	10000	0.06	1000	2000
2.2	±0.1nH, ±0.2nH, ±0.5nH	42	2.2	62	2.2	82	2.3	72	10000	0.07	1000	2000
2.7	±0.1nH, ±0.2nH, ±0.5nH	42	2.7	62	2.8	80	2.9	70	10000	0.08	1000	2000
3.3	±0.1nH, ±0.2nH, ±0.5nH	38	3.3	46	3.4	48	3.5	57	10000	0.11	750	1500
3.9	±0.1nH, ±0.2nH, ±0.5nH	27	3.9	36	4.0	38	4.1	42	10000	0.20	750	1500
4.7	±0.1nH, ±0.2nH, ±0.5nH	43	4.8	62	5.3	76	5.8	60	5500	0.10	750	1500
5.6	±0.5nH	50	5.7	68	6.3	73	7.6	62	4600	0.10	750	1500
6.8	±0.5nH	43	7.0	62	7.7	71	9.4	50	4500	0.11	750	1500
8.2	±0.5nH	43	8.5	56	10.0	55	15.2	32	3500	0.12	750	1500
10	±2%, ±5%	46	10.6	60	13.4	52	-	-	2500	0.13	750	1500
12	±2%, ±5%	40	12.9	50	17.3	40	-	-	2400	0.20	750	1500
15	±2%, ±5%	36	16.7	46	27	23	-	-	2200	0.20	750	1000
18	±2%, ±5%	30	21.9	27	-	-	-	-	1700	0.35	500	1000
22	±2%, ±5%	36	27.5	33	-	-	-	-	1400	0.40	500	1000

(1) I_{DC} measured for 15°C rise at 25°C ambient temperature

(2) I_{DC} measured for 70°C rise at 25°C ambient temperature

L, Q, SRF measured on HP 4291A, Boonton 34A and Wiltron 360
Vector Analyzer, R_{DC} measured on Keithley 580 micro-ohmmeter.



Accu-L[®] 0603 and 0805



SMD High-Q RF Inductor

L0603

Typical Q vs. Frequency
L0603

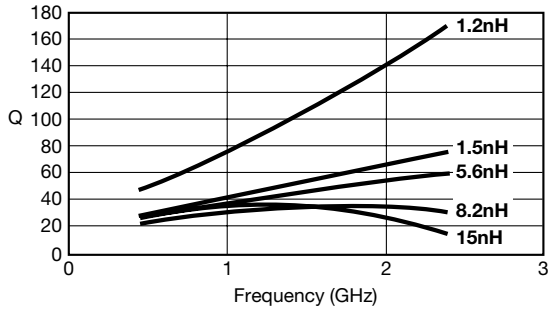

Measured on AGILENT 4291B/4287
using the 16196A test fixture

Typical Inductance vs. Frequency
L0603

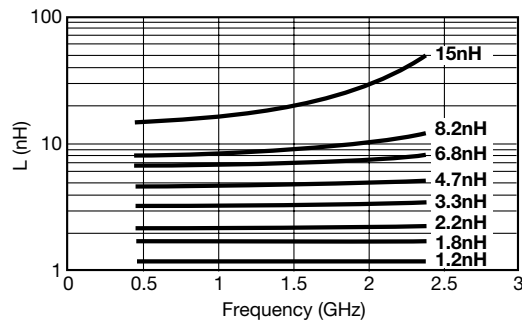

Measured on AGILENT 4291B/4287
using the 16196A test fixture

L0805

Typical Q vs. Frequency
L0805

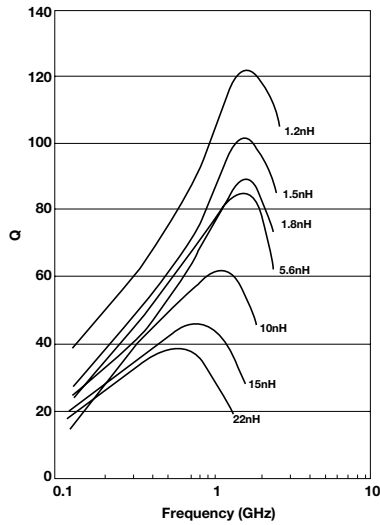

Measured on HP4291A and
Boonton 34A Coaxial Line

Typical Inductance vs. Frequency
L0805

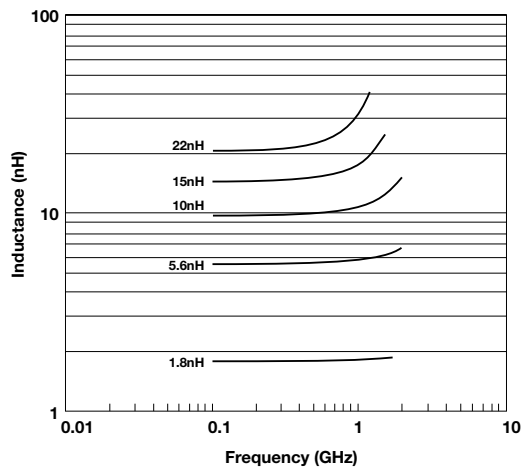

Measured on HP4291A and
Wiltron 360 Vector Analyzer

Maximum Temperature Rise
at 25°C ambient temperature (on FR-4)
L0805

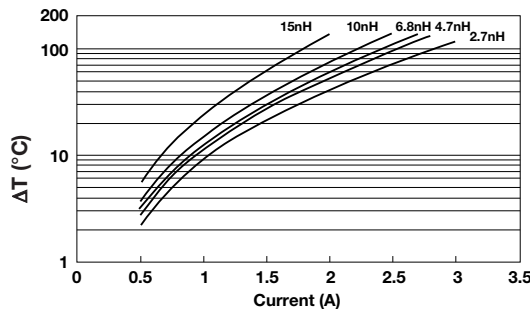

Temperature rise will typically be no higher than shown by the graph



Accu-L[®] 0603 and 0805



SMD High-Q RF Inductor

FINAL QUALITY INSPECTION

Finished parts are tested for electrical parameters and visual/mechanical characteristics.

Parts are 100% tested for inductance at 450MHz. Parts are 100% tested for R_{DC} . Each production lot is evaluated on a sample basis for:

- Q at test frequency
- Static Humidity Resistance: 85°C, 85% RH, 160 hours
- Endurance: 125°C, I_R , 4 hours

2

ENVIRONMENTAL CHARACTERISTICS

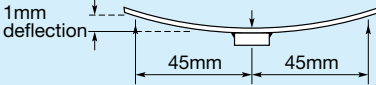
TEST	CONDITIONS	REQUIREMENT
Solderability	Components completely immersed in a solder bath at $235 \pm 5^\circ\text{C}$ for 2 secs.	Terminations to be well tinned. No visible damage.
Leach Resistance	Components completely immersed in a solder bath at $260 \pm 5^\circ\text{C}$ for 60 secs.	Dissolution of termination faces $\leq 15\%$ of area. Dissolution of termination edges $\leq 25\%$ of length.
Storage	12 months minimum with components stored in "as received" packaging.	Good solderability
Shear	Components mounted to a substrate. A force of 5N applied normal to the line joining the terminations and in a line parallel to the substrate.	No visible damage
Rapid Change of Temperature	Components mounted to a substrate. 5 cycles -55°C to $+125^\circ\text{C}$.	No visible damage
Bend Strength	Tested as shown in diagram 	No visible damage
Temperature Coefficient of Inductance (TCL)	Component placed in environmental chamber -55°C to $+125^\circ\text{C}$.	$+0$ to $+125$ ppm/ $^\circ\text{C}$ (typical) $TCL = \frac{L_2 - L_1}{L_1 (T_2 - T_1)} \cdot 10^6$ $T_1 = 25^\circ\text{C}$

Application Notes

HANDLING

SMD chips should be handled with care to avoid damage or contamination from perspiration and skin oils. The use of plastic tipped tweezers or vacuum pick-ups is strongly recommended for individual components. Bulk handling should ensure that abrasion and mechanical shock are minimized. For automatic equipment, taped and reeled product is the ideal medium for direct presentation to the placement machine.

CIRCUIT BOARD TYPE

All flexible types of circuit boards may be used (e.g. FR-4, G-10) and also alumina.

For other circuit board materials, please consult factory.

COMPONENT PAD DESIGN

Component pads must be designed to achieve good joints and minimize component movement during soldering.

Pad designs are given below for both wave and reflow soldering.

The basis of these designs is:

- Pad width equal to component width. It is permissible to decrease this to as low as 85% of component width but it is not advisable to go below this.
- Pad overlap about 0.3mm.
- Pad extension about 0.3mm for reflow.
Pad extension about 0.8mm for wave soldering.

WAVE SOLDERING

DIMENSIONS: millimeters (inches)

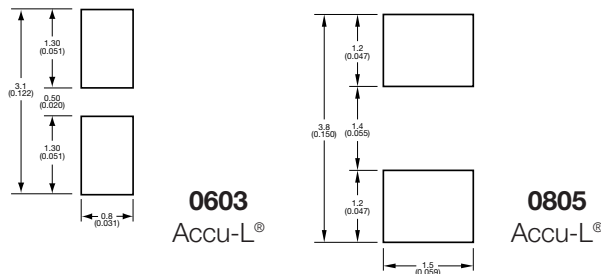

REFLOW SOLDERING

DIMENSIONS: millimeters (inches)

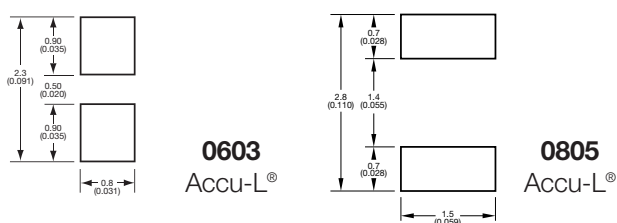

PREHEAT & SOLDERING

The rate of preheat in production should not exceed 4°C/second. It is recommended not to exceed 2°C/second.

Temperature differential from preheat to soldering should not exceed 150°C.

For further specific application or process advice, please consult AVX.

HAND SOLDERING & REWORK

Hand soldering is permissible. Preheat of the PCB to 100°C is required. The most preferable technique is to use hot air soldering tools. Where a soldering iron is used, a temperature controlled model not exceeding 30 watts should be used and set to not more than 260°C. Maximum allowed time at temperature is 1 minute. When hand soldering, the base side (white side) must be soldered to the board.

COOLING

After soldering, the assembly should preferably be allowed to cool naturally. In the event of assisted cooling, similar conditions to those recommended for preheating should be used.

CLEANING RECOMMENDATIONS

Care should be taken to ensure that the devices are thoroughly cleaned of flux residues, especially the space beneath the device. Such residues may otherwise become conductive and effectively offer a lossy bypass to the device. Various recommended cleaning conditions (which must be optimized for the flux system being used) are as follows:

Cleaning liquids i-propanol, ethanol, acetylacetone, water, and other standard PCB cleaning liquids.

Ultrasonic conditions . . . power – 20w/liter max.
frequency – 20kHz to 45kHz.

Temperature 80°C maximum (if not otherwise limited by chosen solvent system).

Time 5 minutes max.

STORAGE CONDITIONS

Recommended storage conditions for Accu-L[®] prior to use are as follows:

Temperature 15°C to 35°C

Humidity ≤65%

Air Pressure 860mbar to 1060mbar

RECOMMENDED SOLDERING PROFILE

For recommended soldering profile see page 23



Thin-Film Technology

CP0402/CP0603/CP0805
and DB0805 3dB 90°
Thin-Film RF/Microwave
Directional Couplers

3

Thin-Film Directional Couplers



CP0402 High Directivity LGA Termination

GENERAL DESCRIPTION

ITF (Integrated Thin-Film) TECHNOLOGY

The ITF High Directivity LGA Coupler is based on thin-film multilayer technology. The technology provides a miniature part with excellent high frequency performance and rugged construction for reliable automatic assembly.

The ITF Coupler is offered in a variety of frequency bands compatible with various types of high frequency wireless systems.

APPLICATIONS

- Mobile Communications
- Satellite TV Receivers
- GPS
- Vehicle Location Systems
- Wireless LAN's

FEATURES

- Inherent Low Profile
- Self Alignment during Reflow
- Excellent Solderability
- Low Parasitics
- Better Heat Dissipation
- Operating/Storage Temp -40°C to +85°C
- Power Rating 3W RF Cont

DIMENSIONS: (Bottom View)

millimeters (inches)

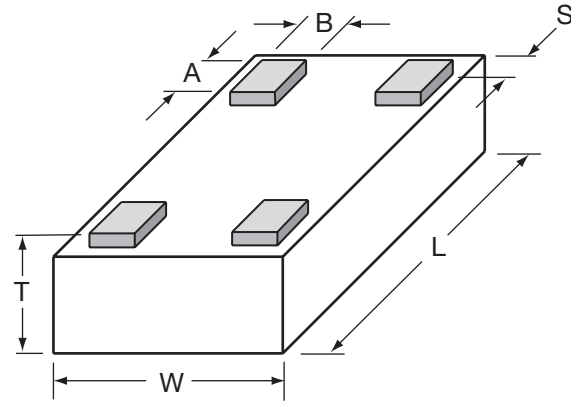

L	1.00±0.05 (0.040±0.002)
W	0.58±0.04 (0.023±0.002)
T	0.35±0.05 (0.014±0.002)

A	0.20±0.05 (0.008±0.002)
B	0.18±0.05 (0.007±0.002)
S	0.05±0.05 (0.002±0.002)

3

HOW TO ORDER

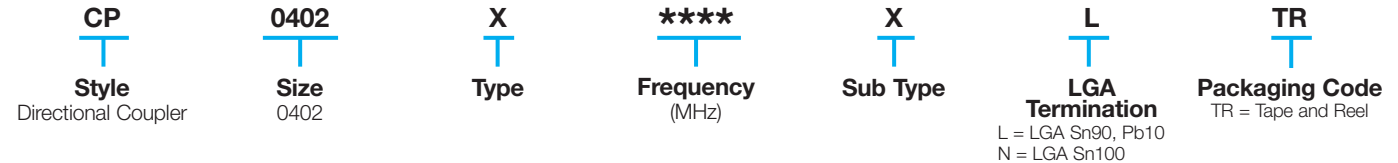

QUALITY INSPECTION

Finished parts are 100% tested for electrical parameters and visual characteristics. Each production lot is evaluated on a sample basis for:

- Static Humidity: 85°C, 85% RH, 160 hours
- Endurance: 125°C, I_R, 4 hours

TERMINATION

Sn90Pb10 or Lead-Free Sn100 Nickel/Solder coating compatible with automatic soldering technologies: reflow, wave soldering, vapor phase and manual.

TERMINALS (Top View)

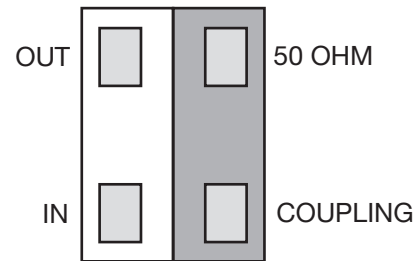

ORIENTATION IN TAPE

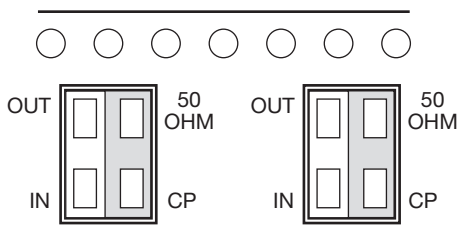

Recommended Pad Layout Dimensions

mm (inches)

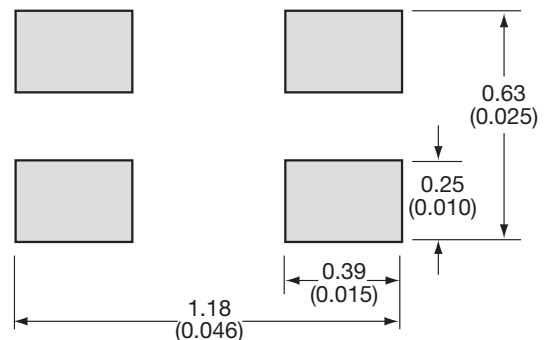

*The recommended distance to the PCB Ground Plane is 0.254mm (0.010")



Thin-Film Directional Couplers



CP0402 High Directivity LGA Termination

COUPLER TYPE SELECTION GRAPH

Coupling vs. Frequency

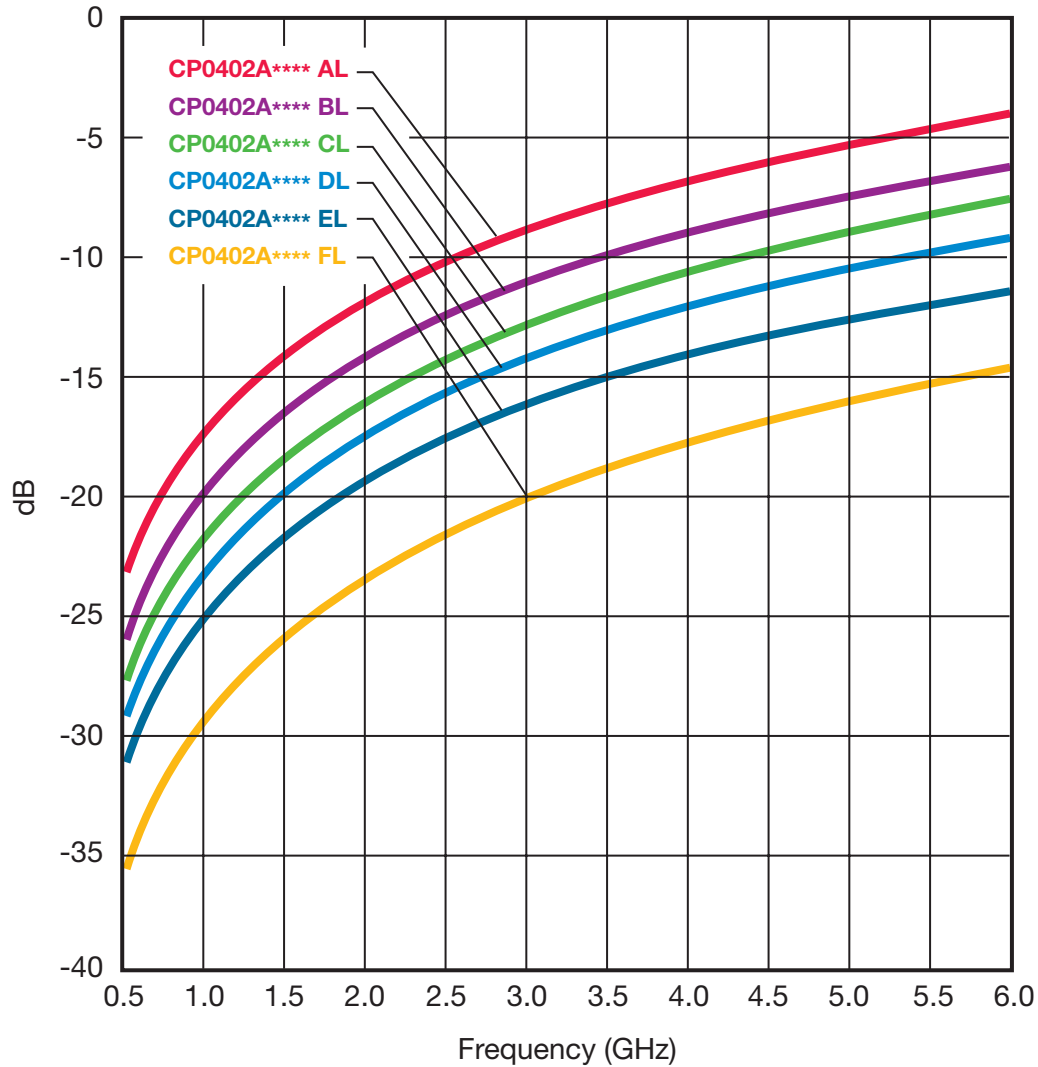

3

Intermediate coupling factors are readily available.
Please contact factory.



Thin-Film Directional Couplers



CP0402 High Directivity LGA Termination

Coupler P/N CP0402AxxxxAL

Application	P/N Examples	Frequency Band [MHz]	Coupling [dB]	I. Loss max. [dB]	Return Loss [dB]	Directivity [dB]
AMPS	CP0402A0836AL	824 - 849	19.10	0.25	32	21
	CP0402A0881AL	869 - 894	18.60			
GSM	CP0402A0902AL	890 - 915	18.50	0.25	31	
	CP0402A0947AL	935 - 960	18.00			
E-GSM	CP0402A0897AL	880 - 915	18.50	0.25	31	
	CP0402A0942AL	925 - 960	18.00			
PDC	CP0402A1441AL	1429 - 1453	14.50	0.40	28	
PCN	CP0402A1747AL	1710 - 1785	13.00	0.50	26	
	CP0402A1842AL	1805 - 1880	12.50			
PCS	CP0402A1880AL	1850 - 1910	12.30	0.50	25	
	CP0402A1960AL	1930 - 1990	12.00			
PHP	CP0402A1907AL	1895 - 1920	12.30	0.50	25	
DECT	CP0402A1890AL	1880 - 1900	12.30	0.70	23	
Wireless LAN	CP0402A2442AL	2400 - 2484	10.30	0.70	23	

CP0402AxxxxALTR

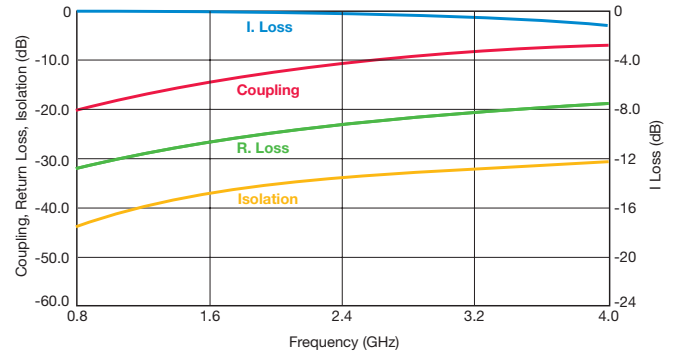

Coupler P/N CP0402AxxxxBL

Application	P/N Examples	Frequency Band [MHz]	Coupling [dB]	I. Loss max. [dB]	Return Loss [dB]	Directivity [dB]
AMPS	CP0402A0836BL	824 - 849	22.00	0.20	28	27
	CP0402A0881BL	869 - 894	21.70			
GSM	CP0402A0902BL	890 - 915	21.50	0.25	27	
	CP0402A0947BL	935 - 960	21.00			
E-GSM	CP0402A0897BL	880 - 915	21.50	0.20	28	
	CP0402A0942BL	925 - 960	21.00			
PDC	CP0402A1441BL	1429 - 1453	17.50	0.25	24	
PCN	CP0402A1747BL	1710 - 1785	16.00	0.30	23	
	CP0402A1842BL	1805 - 1880	15.50			
PCS	CP0402A1880BL	1850 - 1910	15.00	0.35	22	
	CP0402A1960BL	1930 - 1990	15.00			
PHP	CP0402A1907BL	1895 - 1920	15.50	0.35	23	
DECT	CP0402A1890BL	1880 - 1900	15.50	0.40	21	
Wireless LAN	CP0402A2442BL	2400 - 2484	13.30	0.40	21	

CP0402AxxxxBLTR

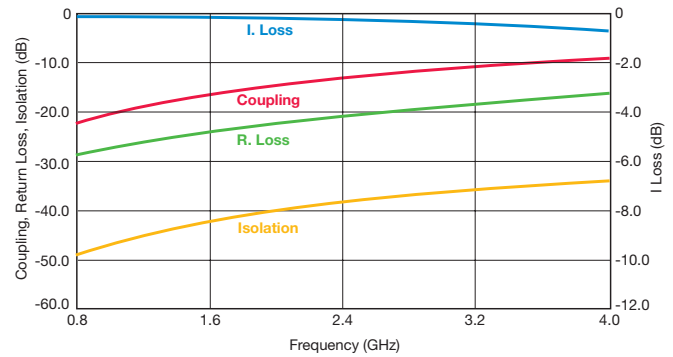

Coupler P/N CP0402AxxxxCL

Application	P/N Examples	Frequency Band [MHz]	Coupling [dB]	I. Loss max. [dB]	Return Loss [dB]	Directivity [dB]
AMPS	CP0402A0836CL	824 - 849	23.60	0.20	33	22
	CP0402A0881CL	869 - 894	23.00			
GSM	CP0402A0902CL	890 - 915	23.00	0.20	26	
	CP0402A0947CL	935 - 960	22.50			
E-GSM	CP0402A0897CL	880 - 915	23.00	0.25	25	
	CP0402A0942CL	925 - 960	22.50			
PDC	CP0402A1441CL	1429 - 1453	19.00	0.25	31	
PCN	CP0402A1747CL	1710 - 1785	17.20	0.25	30	
	CP0402A1842CL	1805 - 1880	17.00			
PCS	CP0402A1880CL	1850 - 1910	16.80	0.25	29	
	CP0402A1960CL	1930 - 1990	16.50			
PHP	CP0402A1907CL	1895 - 1920	16.80	0.25	29	
DECT	CP0402A1890CL	1880 - 1900	16.80	0.45	30	
Wireless LAN	CP0402A2442CL	2400 - 2484	14.70	0.45	28	

CP0402AxxxxCLTR

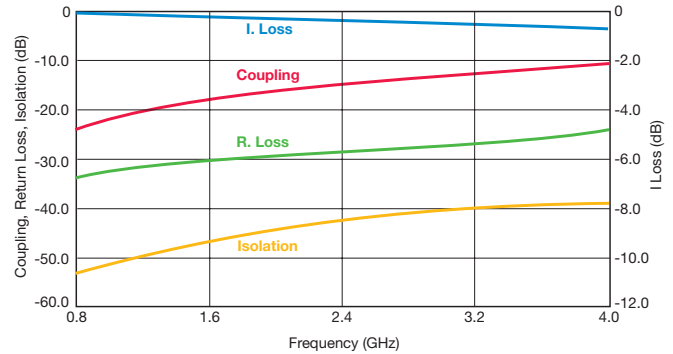

Important: Couplers can be used at any frequency within the indicated range.

Thin-Film Directional Couplers



CP0402 High Directivity LGA Termination

Coupler P/N CP0402AxxxxDL

Application	P/N Examples	Frequency Band [MHz]	Coupling [dB]	I. Loss max. [dB]	Return Loss [dB]	Directivity [dB]						
AMPS	CP0402A0836DL	824 - 849	25.20	0.20	29	20						
	CP0402A0881DL	869 - 894	24.80		28							
GSM	CP0402A0902DL	890 - 915	24.70				25	23				
	CP0402A0947DL	935 - 960	24.10						24			
E-GSM	CP0402A0897DL	880 - 915	24.70							0.25	23	
	CP0402A0942DL	925 - 960	24.10									23
PDC	CP0402A1441DL	1429 - 1453	20.50			0.35						
PCN	CP0402A1747DL	1710 - 1785	19.00		23							
	CP0402A1842DL	1805 - 1880	18.50				23					
PCS	CP0402A1880DL	1850 - 1910	18.20					23				
	CP0402A1960DL	1930 - 1990	18.00						23			
PHP	CP0402A1907DL	1895 - 1920	18.10							23		
DECT	CP0402A1890DL	1880 - 1900	18.20	23								
Wireless LAN	CP0402A2442DL	2400 - 2484	16.00		22							

CP0402AxxxxDLTR

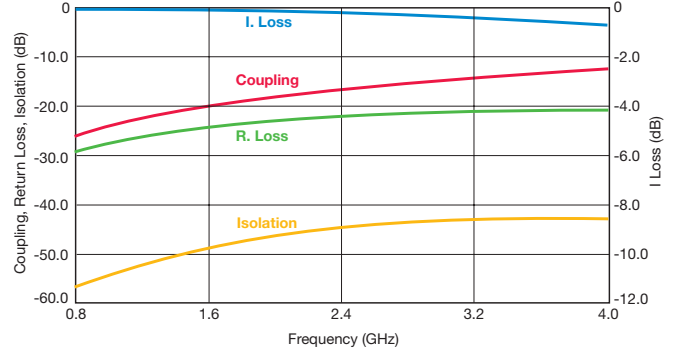

Coupler P/N CP0402AxxxxEL

Application	P/N Examples	Frequency Band [MHz]	Coupling [dB]	I. Loss max. [dB]	Return Loss [dB]	Directivity [dB]						
AMPS	CP0402A0836EL	824 - 849	27.20	0.20	35	25						
	CP0402A0881EL	869 - 894	26.80		34							
GSM	CP0402A0902EL	890 - 915	26.50				29	23				
	CP0402A0947EL	935 - 960	26.00						27			
E-GSM	CP0402A0897EL	880 - 915	26.50							0.25	26	
	CP0402A0942EL	925 - 960	26.00									23
PDC	CP0402A1441EL	1429 - 1453	22.30			0.35						
PCN	CP0402A1747EL	1710 - 1785	20.50		23							
	CP0402A1842EL	1805 - 1880	20.30				23					
PCS	CP0402A1880EL	1850 - 1910	20.00					23				
	CP0402A1960EL	1930 - 1990	20.00						23			
PHP	CP0402A1907EL	1895 - 1920	20.00							23		
DECT	CP0402A1890EL	1880 - 1900	20.00	23								
Wireless LAN	CP0402A2442EL	2400 - 2484	18.00		23							

CP0402AxxxxELTR

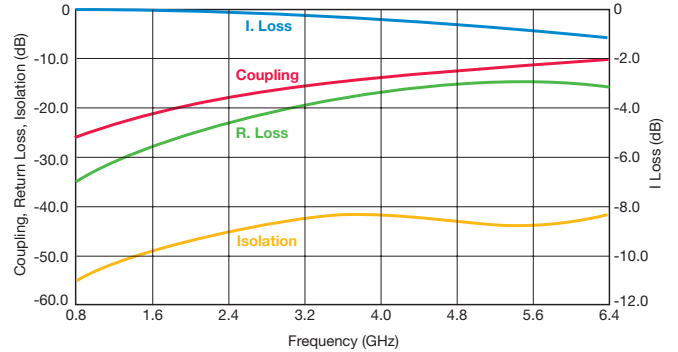

Coupler P/N CP0402AxxxxFL

Application	P/N Examples	Frequency Band [MHz]	Coupling [dB]	I. Loss max. [dB]	Return Loss [dB]	Directivity [dB]		
AMPS	CP0402A0836FL	824 - 849	31.00	0.20	29.10	11		
	CP0402A0881FL	869 - 894	30.70		28.60			
GSM	CP0402A0902FL	890 - 915	30.60		28.50		11	
	CP0402A0947FL	935 - 960	30.00		28.10			
E-GSM	CP0402A0897FL	880 - 915	30.60		28.50			11
	CP0402A0942FL	925 - 960	30.00		28.10			
PDC	CP0402A1441FL	1429 - 1453	26.50		25.00	11		
PCN	CP0402A1747FL	1710 - 1785	25.00		23.80			
	CP0402A1842FL	1805 - 1880	24.50		23.60			
PCS	CP0402A1880FL	1850 - 1910	24.20		23.50		11	
	CP0402A1960FL	1930 - 1990	24.00		23.30			
PHP	CP0402A1907FL	1895 - 1920	24.20		23.40			11
DECT	CP0402A1890FL	1880 - 1900	24.20	23.50				
Wireless LAN	CP0402A2442FL	2400 - 2484	22.00	22.60	11			

CP0402AxxxxFLTR

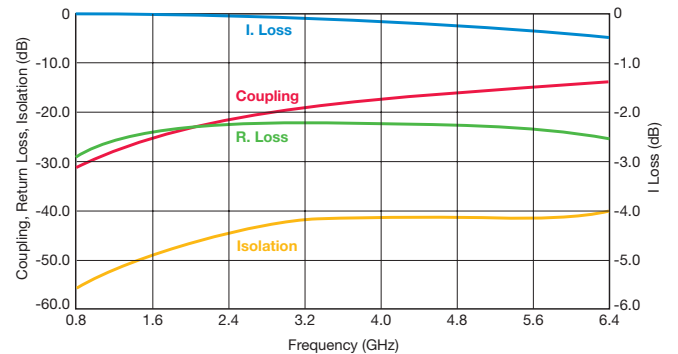

Important: Couplers can be used at any frequency within the indicated range.



Thin-Film Directional Couplers



CP0603 High Directivity LGA Termination

GENERAL DESCRIPTION ITF (Integrated Thin-Film) TECHNOLOGY

The ITF LGA Coupler is based on thin-film multilayer technology. The technology provides a miniature part with excellent high frequency performance and rugged construction for reliable automatic assembly. The ITF Coupler is offered in a variety of frequency bands compatible with various types of high frequency wireless systems.

APPLICATIONS

- Mobile Communications
- Satellite TV Receivers
- GPS
- Vehicle Location Systems
- Wireless LAN's

FEATURES

- Inherent Low Profile
- Self Alignment during Reflow
- Excellent Solderability
- Low Parasitics
- Better Heat Dissipation
- Operating/Storage Temp -40°C to +85°C
- Power Rating 3W RF Cont

DIMENSIONS: (Bottom View)

millimeters (inches)

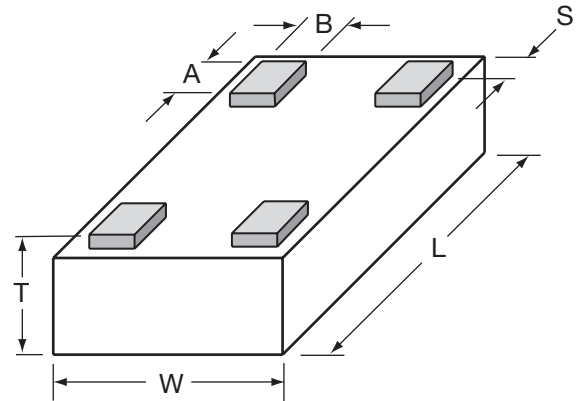

L	1.60±0.10 (0.063±0.004)
W	0.84±0.10 (0.033±0.004)
T	0.60±0.10 (0.024±0.004)

A	0.25±0.05 (0.010±0.002)
B	0.20±0.05 (0.008±0.002)
S	0.05±0.05 (0.002±0.002)

3

HOW TO ORDER

CP └─┘ Style Directional Coupler	0603 └─┘ Size 0603	X └─┘ Type	**** └─┘ Frequency (MHz)	X └─┘ Sub Type	L └─┘ Termination Code L = LGA Sn90, Pb10 N = LGA Sn100	TR └─┘ Packaging Code TR = Tape and Reel
---	---	--------------------------------	---	------------------------------------	---	---

QUALITY INSPECTION

Finished parts are 100% tested for electrical parameters and visual characteristics. Each production lot is evaluated on a sample basis for:

- Static Humidity: 85°C, 85% RH, 160 hours
- Endurance: 125°C, I_R, 4 hours

TERMINATION

Sn90Pb10 or Lead-Free Sn100 Nickel/Solder coating compatible with automatic soldering technologies: reflow, wave soldering, vapor phase and manual.

TERMINALS (Top View)

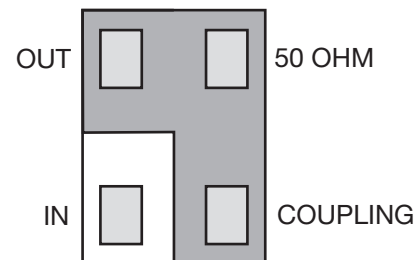

ORIENTATION IN TAPE

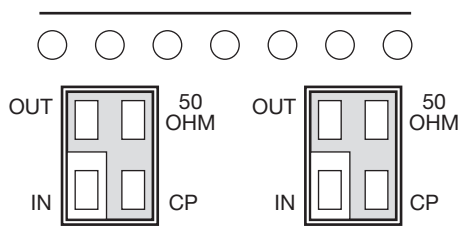

Recommended Pad Layout Dimensions

mm (inches)

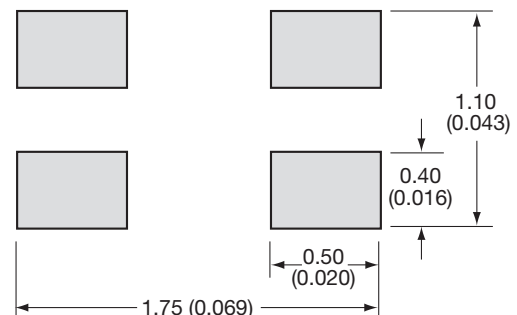

*The recommended distance to the PCB Ground Plane is 0.254mm (0.010")

Thin-Film Directional Couplers



CP0603 High Directivity LGA Termination

COUPLER TYPE SELECTION GRAPH

Coupling vs. Frequency

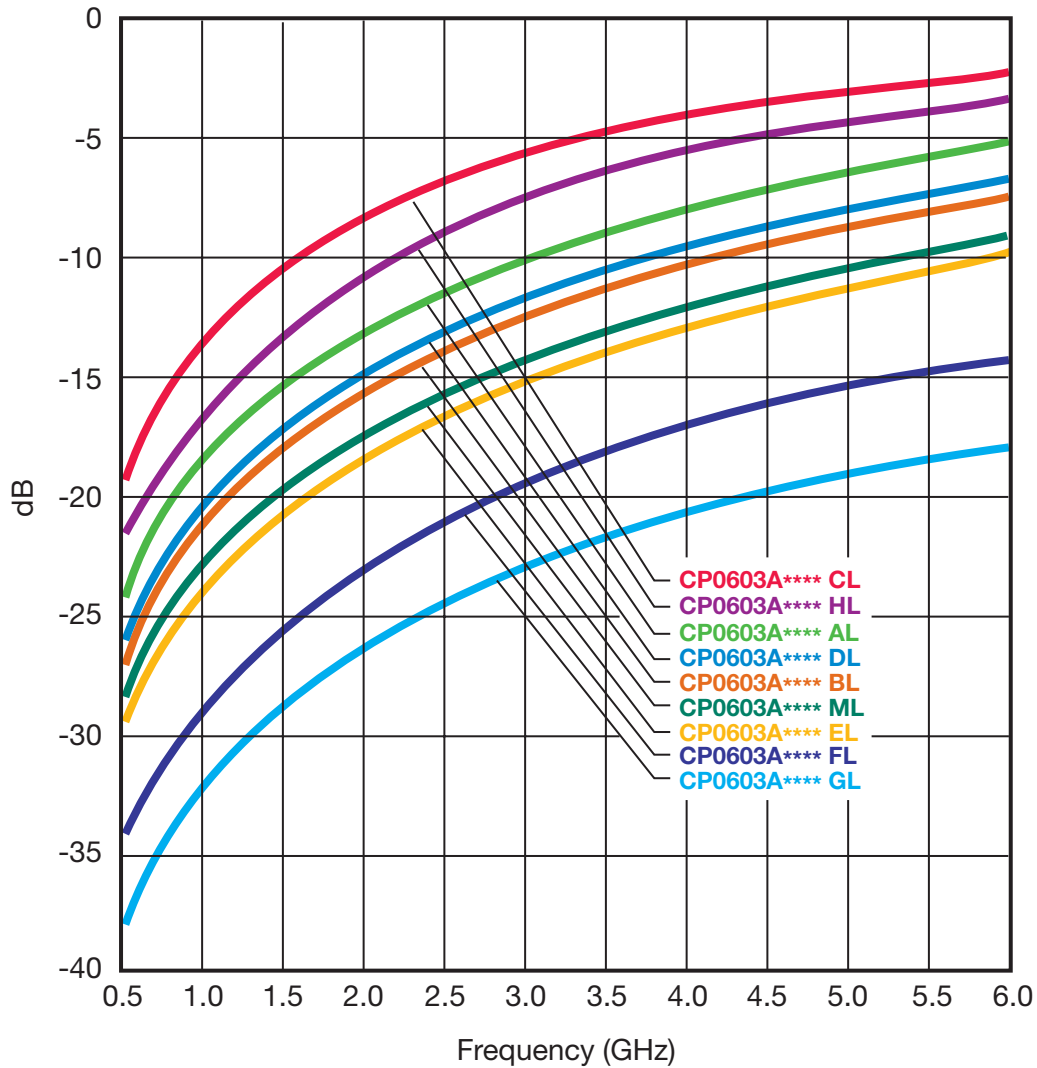

3

Intermediate coupling factors are readily available.
Please contact factory.



Thin-Film Directional Couplers



CP0603 High Directivity LGA Type

Coupler P/N CP0603AxxxxAL

Application	P/N Examples	Frequency Band [MHz]	Coupling [dB]	I. Loss max. [dB]	Return Loss [dB]	Directivity [dB]	
AMPS	CP0603A0836AL	824 - 849	20.0	0.25	28	22	
	CP0603A0881AL	869 - 894	19.7				
GSM	CP0603A0902AL	890 - 915	19.4				
	CP0603A0947AL	935 - 960	19.0				
E-GSM	CP0603A0897AL	880 - 915	19.4				
	CP0603A0942AL	925 - 960	19.0				
PDC	CP0603A1441AL	1429 - 1453	15.5		0.40		24
PCN	CP0603A1747AL	1710 - 1785	14.0		0.50		22
	CP0603A1842AL	1805 - 1880	13.5				
PCS	CP0603A1880AL	1850 - 1910	13.2		0.55		21
	CP0603A1960AL	1930 - 1990	13.0				
PHP	CP0603A1907AL	1895 - 1920	13.2	0.50	22		
DECT	CP0603A1890AL	1880 - 1900	13.2	0.50	22		
Wireless LAN	CP0603A2442AL	2400 - 2484	11.5	0.75	20		

CP0603AxxxxALTR

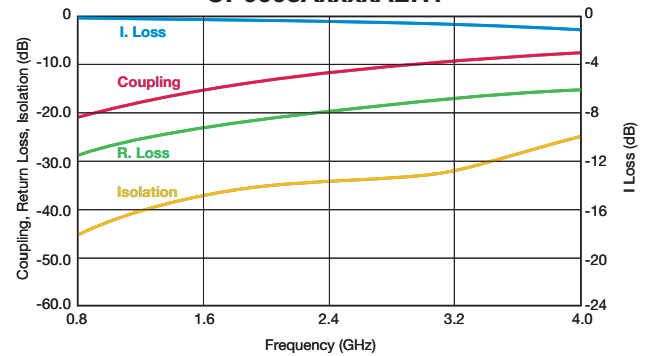

Coupler P/N CP0603AxxxxBL

Application	P/N Examples	Frequency Band [MHz]	Coupling [dB]	I. Loss max. [dB]	Return Loss [dB]	Directivity [dB]	
AMPS	CP0603A0836BL	824 - 849	23.0	0.20	31	29	
	CP0603A0881BL	869 - 894	22.7				
GSM	CP0603A0902BL	890 - 915	22.5				
	CP0603A0947BL	935 - 960	22.0				
E-GSM	CP0603A0897BL	880 - 915	22.5				
	CP0603A0942BL	925 - 960	22.0				
PDC	CP0603A1441BL	1429 - 1453	18.5		0.25		27
PCN	CP0603A1747BL	1710 - 1785	17.0				
	CP0603A1842BL	1805 - 1880	16.4		0.25		25
PCS	CP0603A1880BL	1850 - 1910	16.2				
	CP0603A1960BL	1930 - 1990	16.0	0.35	23		
PHP	CP0603A1907BL	1895 - 1920	16.1				
DECT	CP0603A1890BL	1880 - 1900	16.2	0.35	23		
Wireless LAN	CP0603A2442BL	2400 - 2484	14.2	0.35	23		

CP0603AxxxxBLTR

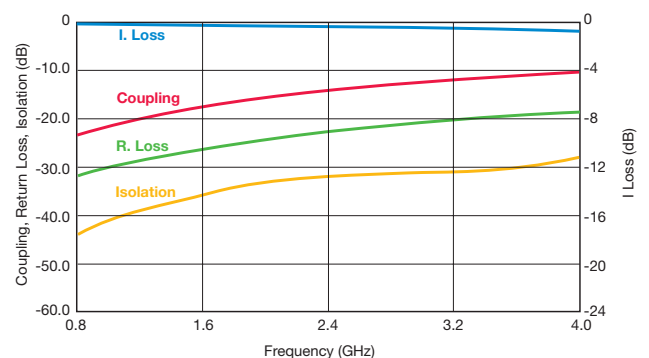

Coupler P/N CP0603AxxxxCL

Application	P/N Examples	Frequency Band [MHz]	Coupling [dB]	I. Loss max. [dB]	Return Loss [dB]	Directivity [dB]	
AMPS	CP0603A0836CL	824 - 849	15.2	0.35	23	23	
	CP0603A0881CL	869 - 894	15.0				
GSM	CP0603A0902CL	890 - 915	14.7				
	CP0603A0947CL	935 - 960	14.3				
E-GSM	CP0603A0897CL	880 - 915	14.7				
	CP0603A0942CL	925 - 960	14.3				
PDC	CP0603A1441CL	1429 - 1453	11.0		0.70		19
PCN	CP0603A1747CL	1710 - 1785	9.5		0.80		18
	CP0603A1842CL	1805 - 1880	9.0				
PCS	CP0603A1880CL	1850 - 1910	8.8		0.90		17
	CP0603A1960CL	1930 - 1990	8.5				
PHP	CP0603A1907CL	1895 - 1920	8.8	0.90	17		
DECT	CP0603A1890CL	1880 - 1900	8.8	0.90	17		
Wireless LAN	CP0603A2442CL	2400 - 2484	7.0	1.40	15		

CP0603AxxxxCLTR

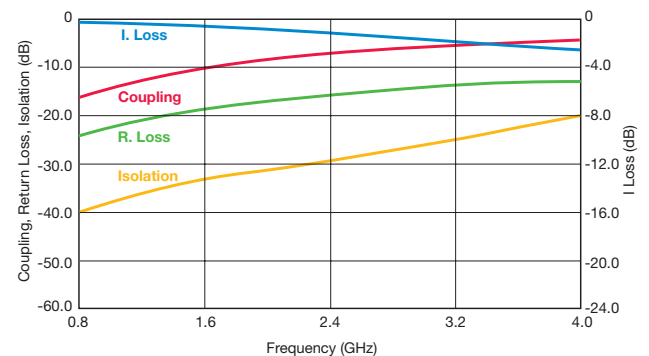

Important: Couplers can be used at any frequency within the indicated range.



Thin-Film Directional Couplers



CP0603 High Directivity LGA Type

Coupler P/N CP0603AxxxxDL

Application	P/N Examples	Frequency Band [MHz]	Coupling [dB]	I. Loss max. [dB]	Return Loss [dB]	Directivity [dB]
AMPS	CP0603A0836DL	824 - 849	22.0	0.25	31	30
	CP0603A0881DL	869 - 894	21.8			
GSM	CP0603A0902DL	890 - 915	21.3	0.30	30	
	CP0603A0947DL	935 - 960	21.0			
E-GSM	CP0603A0897DL	880 - 915	21.3	0.30	30	
	CP0603A0942DL	925 - 960	21.0			
PDC	CP0603A1441DL	1429 - 1453	17.7	0.40	27	
PCN	CP0603A1747DL	1710 - 1785	16.0		25	
	CP0603A1842DL	1805 - 1880	15.4			
PCS	CP0603A1880DL	1850 - 1910	15.2		24	
	CP0603A1960DL	1930 - 1990	15.0			
PHP	CP0603A1907DL	1895 - 1920	15.2	0.55	22	
DECT	CP0603A1890DL	1880 - 1900	15.2			
Wireless LAN	CP0603A2442DL	2400 - 2484	13.3	0.55	22	

CP0603AxxxxDLTR

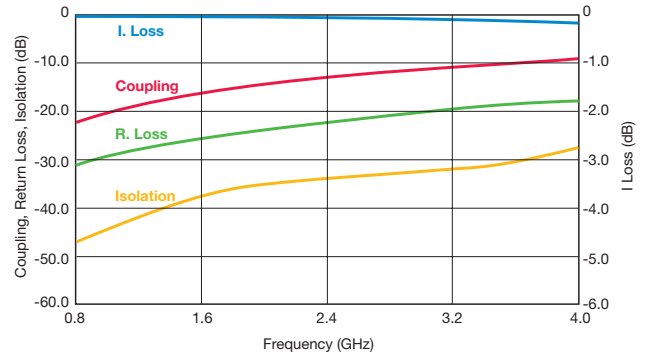

Coupler P/N CP0603AxxxxEL

Application	P/N Examples	Frequency Band [MHz]	Coupling [dB]	I. Loss max. [dB]	Return Loss [dB]	Directivity [dB]
AMPS	CP0603A0836EL	824 - 849	25.8	0.20	32	21
	CP0603A0881EL	869 - 894	25.3			
GSM	CP0603A0902EL	890 - 915	25.0	0.30	31	
	CP0603A0947EL	935 - 960	24.7			
E-GSM	CP0603A0897EL	880 - 915	26.0	0.30	31	
	CP0603A0942EL	925 - 960	24.7			
PDC	CP0603A1441EL	1429 - 1453	22.0	0.40	28	
PCN	CP0603A1747EL	1710 - 1785	19.5		26	
	CP0603A1842EL	1805 - 1880	19.0			
PCS	CP0603A1880EL	1850 - 1910	18.8		24	
	CP0603A1960EL	1930 - 1990	18.5			
PHP	CP0603A1907EL	1895 - 1920	18.7	0.40	24	
DECT	CP0603A1890EL	1880 - 1900	18.8			
Wireless LAN	CP0603A2442EL	2400 - 2484	17.0	0.40	24	

CP0603AxxxxELTR

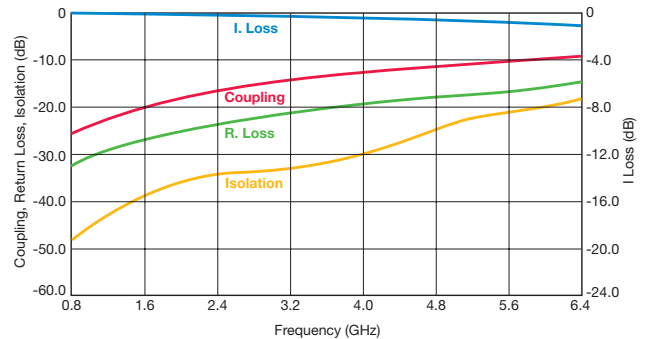

Coupler P/N CP0603AxxxxFL

Application	P/N Examples	Frequency Band [MHz]	Coupling [dB]	I. Loss max. [dB]	Return Loss [dB]	Directivity [dB]
AMPS	CP0603A0836FL	824 - 849	31.2	0.20	38	12
	CP0603A0881FL	869 - 894	30.8			
GSM	CP0603A0902FL	890 - 915	30.5	0.25	37	
	CP0603A0947FL	935 - 960	30.2			
E-GSM	CP0603A0897FL	880 - 915	30.5	0.25	33	
	CP0603A0942FL	925 - 960	30.2			
PDC	CP0603A1441FL	1429 - 1453	27.0	0.25	31	
PCN	CP0603A1747FL	1710 - 1785	25.0			
	CP0603A1842FL	1805 - 1880	26.5			
PCS	CP0603A1880FL	1850 - 1910	24.3			30
	CP0603A1960FL	1930 - 1990	24.0			
PHP	CP0603A1907FL	1895 - 1920	24.2	0.25	31	
DECT	CP0603A1890FL	1880 - 1900	24.2			
Wireless LAN	CP0603A2442FL	2400 - 2484	21.5	0.25	30	

CP0603AxxxxFLTR

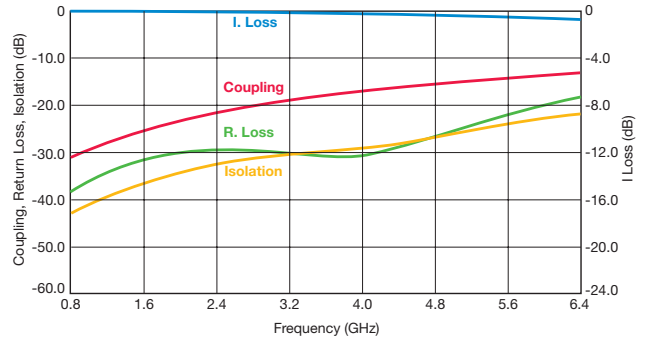

Important: Couplers can be used at any frequency within the indicated range.



Thin-Film Directional Couplers



CP0603 High Directivity LGA Type

Coupler P/N CP0603AxxxxGL

Application	P/N Examples	Frequency Band [MHz]	Coupling [dB]	I. Loss max. [dB]	Return Loss [dB]	Directivity [dB]
AMPS	CP0603A0836GL	824 - 849	34.2	0.20	39	13
	CP0603A0881GL	869 - 894	33.8			
GSM	CP0603A0902GL	890 - 915	33.6	0.25	38	
	CP0603A0947GL	935 - 960	33.2			
E-GSM	CP0603A0897GL	880 - 915	33.6	0.25	38	
	CP0603A0942GL	925 - 960	33.2			
PDC	CP0603A1441GL	1429 - 1453	30.0	0.25	34	
PCN	CP0603A1747GL	1710 - 1785	28.5			
		CP0603A1842GL	1805 - 1880	28.0	0.25	
PCS	CP0603A1880GL	1850 - 1910	27.7			
		CP0603A1960GL	1930 - 1990	27.5	0.25	31
PHP	CP0603A1907GL	1895 - 1920	27.6			
DECT	CP0603A1890GL	1880 - 1900	27.7	0.25	32	
Wireless LAN	CP0603A2442GL	2400 - 2484	25.5			

CP0603AxxxxGLTR

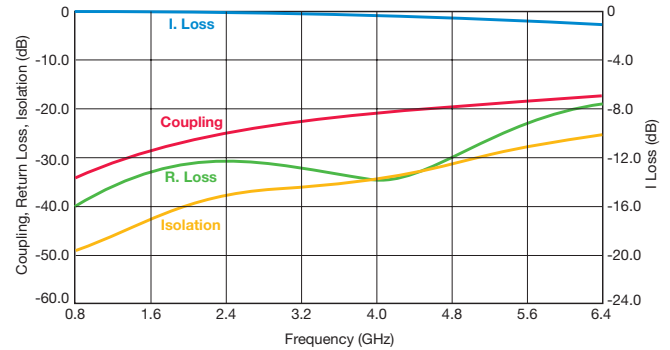

Coupler P/N CP0603AxxxxHL

Application	P/N Examples	Frequency Band [MHz]	Coupling [dB]	I. Loss max. [dB]	Return Loss [dB]	Directivity [dB]
AMPS	CP0603A0836HL	824 - 849	17.3	0.30	26	26
	CP0603A0881HL	869 - 894	17.0			
GSM	CP0603A0902HL	890 - 915	16.7	0.35	25	
	CP0603A0947HL	935 - 960	16.3			
E-GSM	CP0603A0897HL	880 - 915	17.0	0.55	22	
	CP0603A0942HL	925 - 960	16.3			
PDC	CP0603A1441HL	1429 - 1453	13.0	0.75	20	
PCN	CP0603A1747HL	1710 - 1785	11.4			
		CP0603A1842HL	1805 - 1880	11.0	0.75	19
PCS	CP0603A1880HL	1850 - 1910	10.8			
		CP0603A1960HL	1930 - 1990	10.5	0.75	19
PHP	CP0603A1907HL	1895 - 1920	10.7			
DECT	CP0603A1890HL	1880 - 1900	10.8	1.00	17	
Wireless LAN	CP0603A2442HL	2400 - 2484	8.8			

CP0603AxxxxHLTR

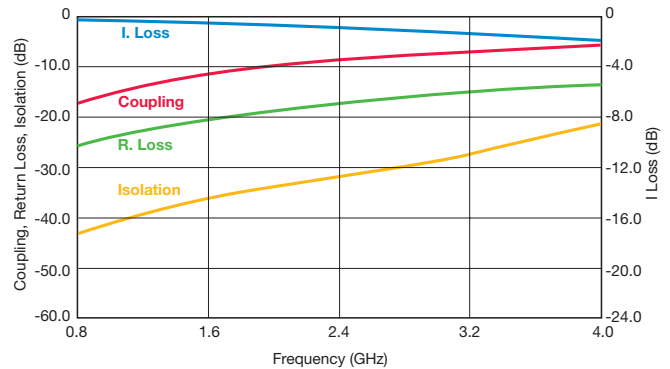

Coupler P/N CP0603AxxxxML

Application	P/N Examples	Frequency Band [MHz]	Coupling [dB]	I. Loss max. [dB]	Return Loss [dB]	Directivity [dB]
AMPS	CP0603A0836ML	824 - 849	24.2	0.20	33	23
	CP0603A0881ML	869 - 894	23.8			
GSM	CP0603A0902ML	890 - 915	23.4	0.25	32	
	CP0603A0947ML	935 - 960	23.2			
E-GSM	CP0603A0897ML	880 - 915	23.4	0.35	28	
	CP0603A0942ML	925 - 960	23.2			
PDC	CP0603A1441ML	1429 - 1453	20.0	0.35	27	
PCN	CP0603A1747ML	1710 - 1785	18.4			
		CP0603A1842ML	1805 - 1880	18.0	0.35	26
PCS	CP0603A1880ML	1850 - 1910	17.8			
		CP0603A1960ML	1930 - 1990	17.5	0.35	26
PHP	CP0603A1907ML	1895 - 1920	17.7			
DECT	CP0603A1890ML	1880 - 1900	17.8	0.35	24	
Wireless LAN	CP0603A2442ML	2400 - 2484	15.6			

CP0603AxxxxMLTR

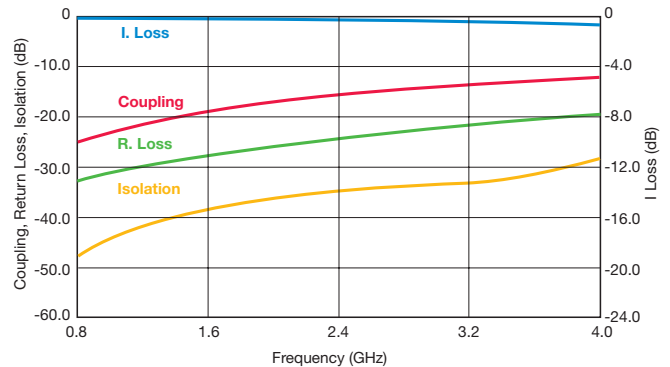

Important: Couplers can be used at any frequency within the indicated range.



Thin-Film Directional Couplers



CP0402 / CP0603 High Directivity Couplers Test Jigs

GENERAL DESCRIPTION

These jigs are designed for testing the CP0402 and CP0603 High Directivity Couplers using a Vector Network Analyzer.

They consist of a dielectric substrate, having 50Ω microstrips as conducting lines and a bottom ground plane located at a distance of 0.254mm (0.010") from the microstrips.

The substrate used is Neltec's NH9338ST0254C1BC.

The connectors are SMA type (female), 'Johnson Components Inc.' Product P/N: 142-0701-841.

Both a measurement jig and a calibration jig are provided.

The calibration jig is designed for a full 2-port calibration, and consists of an open line, short line and through line. LOAD calibration can be done by a 50Ω SMA termination.

MEASUREMENT PROCEDURE

When measuring a component, it can be either soldered or pressed using a non-metallic stick until all four ports touch the appropriate pads. Set the VNA to the relevant frequency band. Connect the VNA using a 10dB attenuator on the jig

terminal connected to port 2. Follow the VNA's instruction manual and use the [calibration jig](#) to perform a full 2-Port calibration in the required bandwidths.

3

Place the coupler on the **measurement jig** as follows:

Input (Coupler) → Connector 1 (Jig) Termination (Coupler) → Connector 3 (Jig)
Output (Coupler) → Connector 2 (Jig) Coupling (Coupler) → Connector 4 (Jig)

To measure **I. Loss** connect:

Connector 1 (Jig) → Port 1 (VNA) Connector 3 (Jig) → 50Ω
Connector 2 (Jig) → Port 2 (VNA) Connector 4 (Jig) → 50Ω

To measure **R. Loss and Coupling** connect:

Connector 1 (Jig) → Port 1 (VNA) Connector 3 (Jig) → 50Ω
Connector 2 (Jig) → 50Ω Connector 4 (Jig) → Port 2 (VNA)

To measure **Isolation** connect:

Connector 1 (Jig) → 50Ω Connector 3 (Jig) → 50Ω
Connector 2 (Jig) → Port 1 (VNA) Connector 4 (Jig) → Port 2 (VNA)

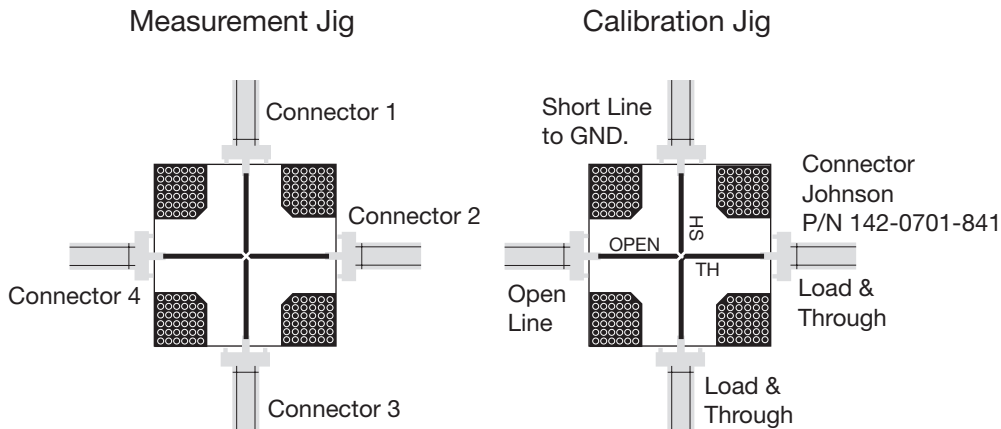

Thin-Film Directional Couplers



CP0603 SMD Type

GENERAL DESCRIPTION ITF (Integrated Thin-Film) TECHNOLOGY

The ITF SMD Coupler is based on thin-film multilayer technology. The technology provides a miniature part with excellent high frequency performance and rugged construction for reliable automatic assembly. The ITF Coupler is offered in a variety of frequency bands compatible with various types of high frequency wireless systems.

DIMENSIONS:

millimeters (inches)

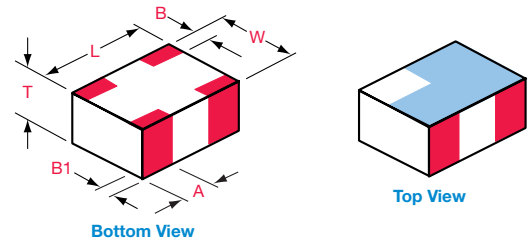

	0603
L	1.6±0.1 (0.063±0.004)
W	0.84±0.1 (0.033±0.004)
T	0.60±0.1 (0.028±0.004)
A	0.35±0.15 (0.014±0.006)
B	0.175±0.1 (0.007±0.004)
B1	0.00+0.1/0-0.0 (0.00+0.004/-0.0)

APPLICATIONS

- Mobile Communications
- Satellite TV Receivers
- GPS
- Vehicle Location Systems
- Wireless LAN's

FEATURES

- Miniature Size: 0603
- Frequency Range: 800MHz - 3GHz
- Characteristic Impedance: 50Ω
- Operating / Storage Temp.: -40°C to +85°C
- Power Rating: 3W Continuous
- Low Profile
- Rugged Construction
- Taped and Reeled

3

HOW TO ORDER



QUALITY INSPECTION

Finished parts are 100% tested for electrical parameters and visual characteristics. Each production lot is evaluated on a sample basis for:

- Static Humidity: 85°C, 85% RH, 160 hours
- Endurance: 125°C, I_R, 4 hours

TERMINATION

Nickel/Solder coating compatible with automatic soldering technologies: reflow, wave soldering, vapor phase and manual.

Recommended Pad Layout Dimensions mm (inches)

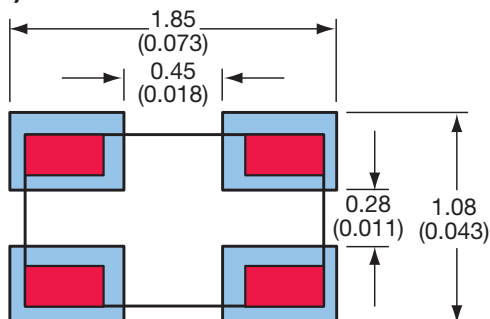

TERMINALS (Top View)

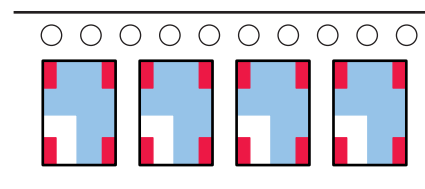
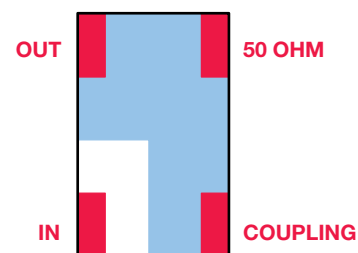

Orientation in tape

Thin-Film Directional Couplers



CP0603 SMD Type

Coupler P/N CP0603A****AW

Application	P/N Examples	Frequency Band [MHz]	Coupling [dB]	I. Loss max	VSWR max
AMPS	CP0603A0836AW	824 - 849	18.5±1	0.25	1.2
	CP0603A0881AW	869 - 894	18.5±1		
GSM	CP0603A0902AW	890 - 915	18±1	0.25	
	CP0603A0947AW	935 - 960	17.5±1		
E-GSM	CP0603A0897AW	880 - 915	18±1	0.4	
	CP0603A0942AW	925 - 960	17.5±1		
PDC	CP0603A1441AW	1429 - 1453	14±1	0.6	
PCN	CP0603A1747AW	1710 - 1785	12.5±1		
	CP0603A1842AW	1805 - 1880	12±1		
PCS	CP0603A1880AW	1850 - 1910	12±1	0.6	
	CP0603A1960AW	1930 - 1990	11.5±1		
PHP	CP0603A1907AW	1895 - 1920	12±1	0.85	
DECT	CP0603A1890AW	1880 - 1900	12±1		
Wireless LAN	CP0603A2442AW	2400 - 2484	10±1		

P/N CP0603A****AW

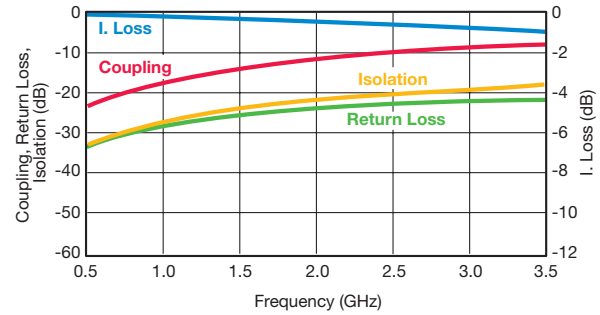

Coupler P/N CP0603A****BW

Application	P/N Examples	Frequency Band [MHz]	Coupling [dB]	I. Loss max	VSWR max
AMPS	CP0603A0836BW	824 - 849	16±1	0.25	1.2
	CP0603A0881BW	869 - 894	15.5±1		
GSM	CP0603A0902BW	890 - 915	15.5±1	0.55	
	CP0603A0947BW	935 - 960	15±1		
E-GSM	CP0603A0897BW	880 - 915	15.5±1	0.8	
	CP0603A0942BW	925 - 960	15±1		
PDC	CP0603A1441BW	1429 - 1453	11.5±1	1.3	
PCN	CP0603A1747BW	1710 - 1785	10±1		1.4
	CP0603A1842BW	1805 - 1880	9.5±1		
PCS	CP0603A1880BW	1850 - 1910	9±1	1.1	
	CP0603A1960BW	1930 - 1990	9±1		
PHP	CP0603A1907BW	1895 - 1920	9±1		
DECT	CP0603A1890BW	1880 - 1900	9±1		
Wireless LAN	CP0603A2442BW	2400 - 2484	7.5±1		

CP0603A****BW

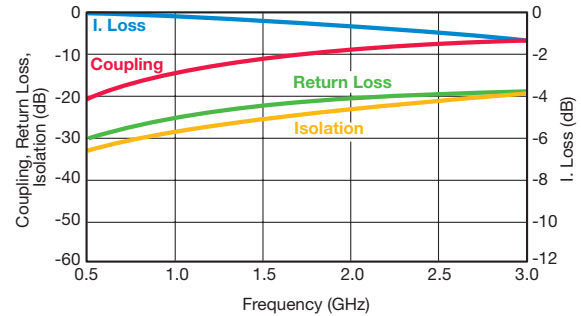

Coupler P/N CP0603A****CW

Application	P/N Examples	Frequency Band [MHz]	Coupling [dB]	I. Loss max	VSWR max
AMPS	CP0603A0836CW	824 - 849	21±1	0.25	1.2
	CP0603A0881CW	869 - 894	20.5±1		
GSM	CP0603A0902CW	890 - 915	20.5±1	0.40	
	CP0603A0947CW	935 - 960	20±1		
E-GSM	CP0603A0897CW	880 - 915	20.5±1	0.5	
	CP0603A0942CW	925 - 960	20±1		
PDC	CP0603A1441CW	1429 - 1453	16.5±1	0.65	
PCN	CP0603A1747CW	1710 - 1785	15±1		
	CP0603A1842CW	1805 - 1880	14.5±1		
PCS	CP0603A1880CW	1850 - 1910	14.5±1		
	CP0603A1960CW	1930 - 1990	14±1		
PHP	CP0603A1907CW	1895 - 1920	14.5±1		
DECT	CP0603A1890CW	1880 - 1900	14.5±1		
Wireless LAN	CP0603A2442CW	2400 - 2484	12.5±1		

CP0603A****CW

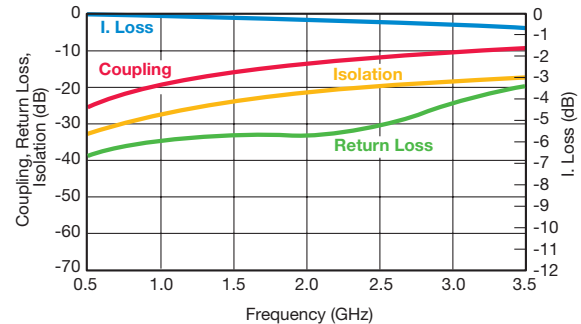

Coupler P/N CP0603A****DW

Application	P/N Examples	Frequency Band [MHz]	Coupling [dB]	I. Loss max	VSWR max
AMPS	CP0603A0836DW	824 - 849	15.0±1	0.40	1.2
	CP0603A0881DW	869 - 894	14.5±1		
GSM	CP0603A0902DW	890 - 915	14.5±1	0.7	
	CP0603A0947DW	935 - 960	14±1		
E-GSM	CP0603A0897DW	880 - 915	14.5±1	0.9	
	CP0603A0942DW	925 - 960	14±1		
PDC	CP0603A1441DW	1429 - 1453	10.5±1	1.0	
PCN	CP0603A1747DW	1710 - 1785	9±1		1.5
	CP0603A1842DW	1805 - 1880	8.5±1		
PCS	CP0603A1880DW	1850 - 1910	8.5±1		
	CP0603A1960DW	1930 - 1990	8±1		
PHP	CP0603A1907DW	1895 - 1920	8.5±1		
DECT	CP0603A1890DW	1880 - 1900	8.5±1		
Wireless LAN	CP0603A2442DW	2400 - 2484	6.5±1		

CP0603A****DW

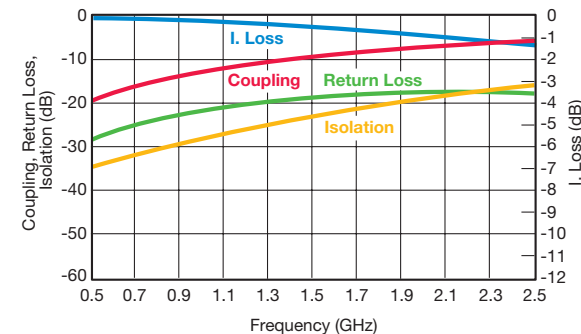

Important: Couplers can be used at any frequency within the indicated range.



Thin-Film Directional Couplers



CP0603 SMD Type

Coupler P/N CP0603B****AW

Application	P/N Examples	Frequency Band [MHz]	Coupling [dB]	I. Loss max	VSWR max	
AMPS	CP0603B0836AW	824 - 849	24.5±1	0.2	1.2	
	CP0603B0881AW	869 - 894	24±1			
GSM	CP0603B0902AW	890 - 915	24±1			
	CP0603B0947AW	935 - 960	23.5±1			
E-GSM	CP0603B0897AW	880 - 915	24±1			0.25
	CP0603B0942AW	925 - 960	23.5±1			
PDC	CP0603B1441AW	1429 - 1453	20±1	0.3		
PCN	CP0603B1747AW	1710 - 1785	18±1			
	CP0603B1842AW	1805 - 1880	17.5±1			
PCS	CP0603B1880AW	1850 - 1910	17.5±1	0.3		
	CP0603B1960AW	1930 - 1990	17.5±1			
PHP	CP0603B1907AW	1895 - 1920	17.5±1	0.45		
DECT	CP0603B1890AW	1880 - 1900	17.5±1			
Wireless LAN	CP0603B2442AW	2400 - 2484	15.5±1			

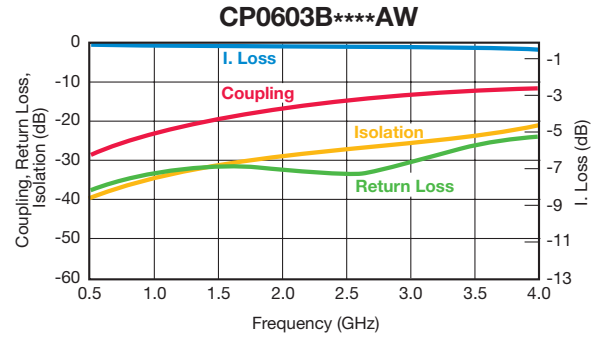

Coupler P/N CP0603B****BW

Application	P/N Examples	Frequency Band [MHz]	Coupling [dB]	I. Loss max	VSWR max	
AMPS	CP0603B0836BW	824 - 849	25.5±1	0.2	1.2	
	CP0603B0881BW	869 - 894	25±1			
GSM	CP0603B0902BW	890 - 915	25±1			
	CP0603B0947BW	935 - 960	24.5±1			
E-GSM	CP0603B0897BW	880 - 915	25±1			0.25
	CP0603B0942BW	925 - 960	24.5±1			
PDC	CP0603B1441BW	1429 - 1453	21±1	0.25		
PCN	CP0603B1747BW	1710 - 1785	19±1			
	CP0603B1842BW	1805 - 1880	19±1			
PCS	CP0603B1880BW	1850 - 1910	18.5±1	0.35		
	CP0603B1960BW	1930 - 1990	18.5±1			
PHP	CP0603B1907BW	1895 - 1920	18.5±1	0.35		
DECT	CP0603B1890BW	1880 - 1900	18.5±1			
Wireless LAN	CP0603B2442BW	2400 - 2484	16.5±1			

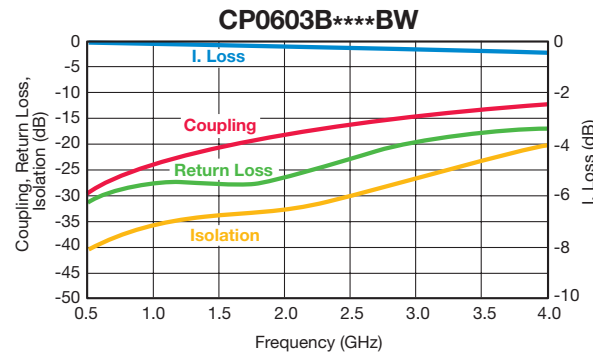

Coupler P/N CP0603B****CW

Application	P/N Examples	Frequency Band [MHz]	Coupling [dB]	I. Loss max	VSWR max	
AMPS	CP0603B0836CW	824 - 849	26.5±1	0.2	1.2	
	CP0603B0881CW	869 - 894	26±1			
GSM	CP0603B0902CW	890 - 915	26±1			
	CP0603B0947CW	935 - 960	25.5±1			
E-GSM	CP0603B0897CW	880 - 915	26±1			0.25
	CP0603B0942CW	925 - 960	25.5±1			
PDC	CP0603B1441CW	1429 - 1453	22±1	0.25		
PCN	CP0603B1747CW	1710 - 1785	20.5±1			
	CP0603B1842CW	1805 - 1880	20±1			
PCS	CP0603B1880CW	1850 - 1910	20±1	0.35		
	CP0603B1960CW	1930 - 1990	19.5±1			
PHP	CP0603B1907CW	1895 - 1920	20±1	1.3		
DECT	CP0603B1890CW	1880 - 1900	20±1			
Wireless LAN	CP0603B2442CW	2400 - 2484	18±1			

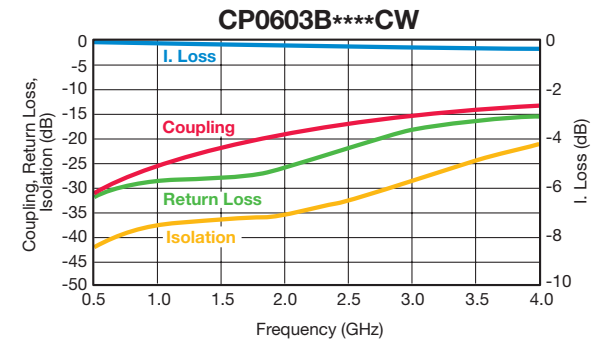

Important: Couplers can be used at any frequency within the indicated range.



Thin-Film Directional Couplers



CP0603 SMD Type – High Directivity

Coupler P/N CP0603D****AW

Application	P/N Examples	Frequency Band [MHz]	Coupling [dB]	I. Loss max. [dB]	Return Loss [dB]	Directivity [dB]
AMPS	CP0603D0836AW	824 - 849	13.50	0.50	23	21
	CP0603D0881AW	869 - 894	13.00			
GSM	CP0603D0902AW	890 - 915	12.50	1.00	18	19
	CP0603D0947AW	935 - 960	13.00			
E-GSM	CP0603D0897AW	880 - 915	12.50	1.40	17	17
	CP0603D0942AW	925 - 960	7.00			
PDC	CP0603D1441AW	1429 - 1453	9.00	2.00	15	15
PCN	CP0603D1747AW	1710 - 1785	8.00	7.50	16	17
	CP0603D1842AW	1805 - 1880	7.00			
PCS	CP0603D1880AW	1850 - 1910	7.00	11.00	24	19
	CP0603D1960AW	1930 - 1990	13.00			
PHP	CP0603D1907AW	1895 - 1920	13.00	0.70	24	19
DECT	CP0603D1890AW	1880 - 1900	13.00	0.70	24	19
Wireless LAN	CP0603D2442AW	2400 - 2484	5.50	2.00	15	15

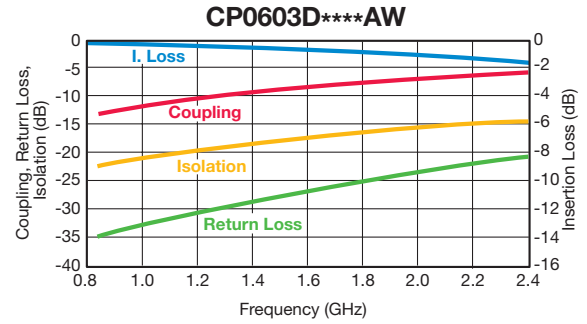

Coupler P/N CP0603D****BW

Application	P/N Examples	Frequency Band [MHz]	Coupling [dB]	I. Loss max. [dB]	Return Loss [dB]	Directivity [dB]
AMPS	CP0603D0836BW	824 - 849	20.00	0.25	36	19
	CP0603D0881BW	869 - 894	19.50			
GSM	CP0603D0902BW	890 - 915	19.00	0.50	28	19
	CP0603D0947BW	935 - 960	19.00			
E-GSM	CP0603D0897BW	880 - 915	19.50	0.55	27	19
	CP0603D0942BW	925 - 960	19.00			
PDC	CP0603D1441BW	1429 - 1453	15.50	0.40	30	19
PCN	CP0603D1747BW	1710 - 1785	14.00	13.50	27	19
	CP0603D1842BW	1805 - 1880	13.00			
PCS	CP0603D1880BW	1850 - 1910	13.00	11.00	24	19
	CP0603D1960BW	1930 - 1990	13.00			
PHP	CP0603D1907BW	1895 - 1920	13.00	0.70	24	19
DECT	CP0603D1890BW	1880 - 1900	13.00	0.70	24	19
Wireless LAN	CP0603D2442BW	2400 - 2484	11.00	0.70	24	19

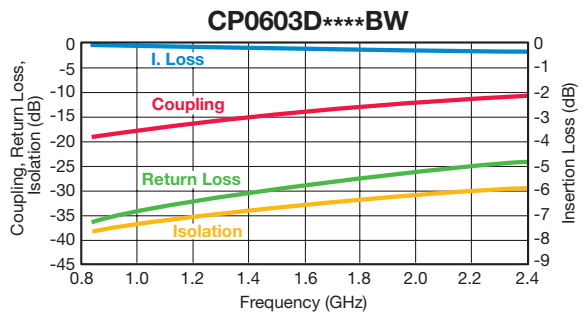

3

Important: Couplers can be used at any frequency within the indicated range.



Thin-Film Directional Couplers



CP0805 Type

GENERAL DESCRIPTION ITF (Integrated Thin-Film) TECHNOLOGY

The ITF SMD Coupler is based on thin-film multilayer technology. The technology provides a miniature part with excellent high frequency performance and rugged construction for reliable automatic assembly. The ITF Coupler is offered in a variety of frequency bands compatible with various types of high frequency wireless systems.

FEATURES

- Small Size: 0805
- Frequency Range: 800MHz - 3GHz
- Characteristic Impedance: 50Ω
- Operating / Storage Temp.: -40°C to +85°C
- Power Rating: 3W Continuous
- Low Profile
- Rugged Construction
- Taped and Reeled

APPLICATIONS

- Mobile Communications
- Satellite TV Receivers
- GPS
- Vehicle Location Systems
- Wireless LAN's

DIMENSIONS: (Top View)

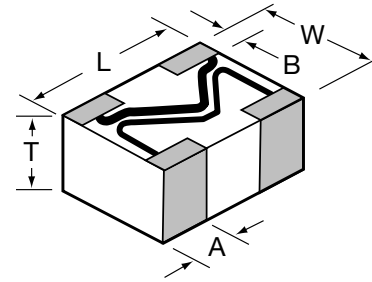

	0805
L	2.03±0.1 (0.080±0.004)
W	1.55±0.1 (0.061±0.004)
T	0.98±0.1 (0.039±0.004)
A	0.56±0.25 (0.022±0.010)
B	0.35±0.15 (0.014±0.006)

3

HOW TO ORDER



QUALITY INSPECTION

Finished parts are 100% tested for electrical parameters and visual characteristics. Each production lot is evaluated on a sample basis for:

- Static Humidity: 85°C, 85% RH, 160 hours
- Endurance: 125°C, I_R, 4 hours

TERMINATION

Nickel/Solder coating (Sn, Pb) compatible with automatic soldering technologies: reflow, wave soldering, vapor phase and manual.

Recommended Pad Layout Dimensions mm (inches)

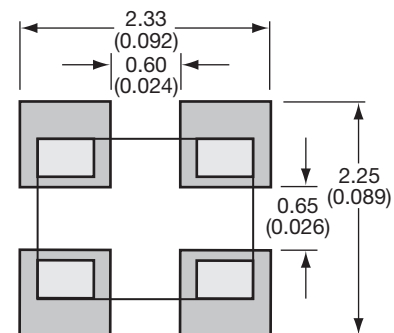

NOTE: Components must be mounted on the board with the white (Alumina) side DOWN.

Thin-Film Directional Couplers



CP0805 Layout Types

LAYOUT

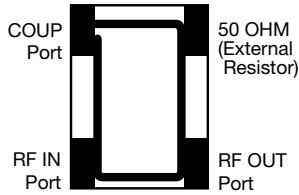

Type: A
Sub-Type: A

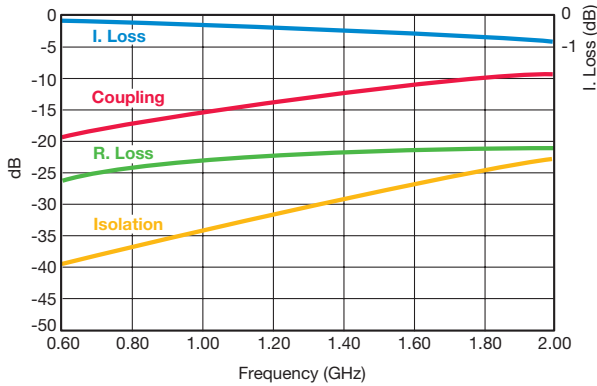

Application	P/N Examples	Frequency Band [MHz]	Coupling [dB]	I. Loss max	VSWR max
AMPS	CP0805A0836AW	824 - 849	16.5±1	0.25	1.2
	CP0805A0881AW	869 - 894	16±1		
GSM	CP0805A0902AW	890 - 915	16±1		
	CP0805A0947AW	935 - 960	15.5±1		
E-GSM	CP0805A0897AW	880 - 915	16±1		
	CP0805A0942AW	925 - 960	15.5±1		
PDC	CP0805A1441AW	1429 - 1453	12±1	0.5	1.3
PCN	CP0805A1747AW	1710 - 1785	10.5±1	0.7	1.4
	CP0805A1842AW	1805 - 1880	10±1	0.8	
PCS	CP0805A1880AW	1850 - 1910	9.5±1		
	CP0805A1960AW	1930 - 1990	9.5±1		
PHP	CP0805A1907AW	1895 - 1920	9.5±1		
DECT	CP0805A1890AW	1880 - 1900	9.5±1		

LAYOUT

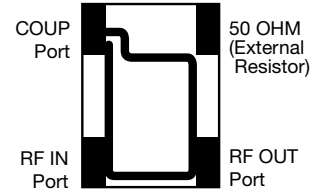

Type: A
Sub-Type: B

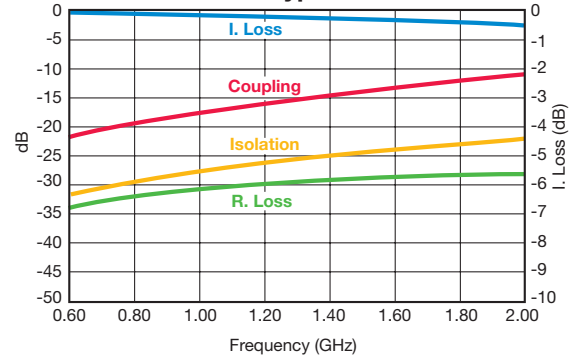

Application	P/N Examples	Frequency Band [MHz]	Coupling [dB]	I. Loss max	VSWR max
AMPS	CP0805A0836BW	824 - 849	19±1	0.25	1.2
	CP0805A0881BW	869 - 894	18.5±1		
GSM	CP0805A0902BW	890 - 915	18±1		
	CP0805A0947BW	935 - 960	18±1		
E-GSM	CP0805A0897BW	880 - 915	18.5±1		
	CP0805A0942BW	925 - 960	18±1		
PDC	CP0805A1441BW	1429 - 1453	14.5±1	0.35	
PCN	CP0805A1747BW	1710 - 1785	12.5±1	0.5	1.4
	CP0805A1842BW	1805 - 1880	12.5±1	0.6	
PCS	CP0805A1880BW	1850 - 1910	12±1	0.6	
	CP0805A1960BW	1930 - 1990	11.5±1	0.7	
PHP	CP0805A1907BW	1895 - 1920	12±1	0.6	
DECT	CP0805A1890BW	1880 - 1900	12±1		
Wireless LAN	CP0805A2442BW	2400 - 2484	10±1	0.9	

Type: A
Sub-Type: C

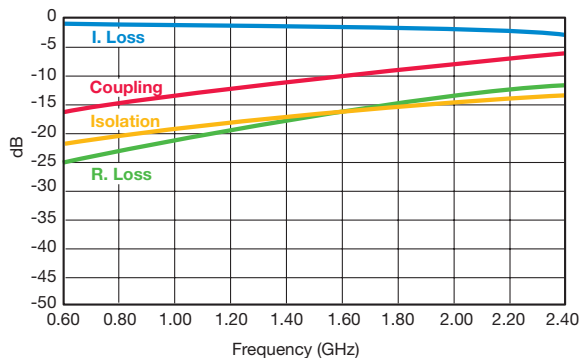

LAYOUT

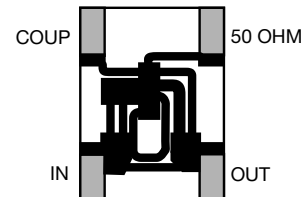

Application	P/N Examples	Frequency Band [MHz]	Coupling [dB]	I. Loss max	VSWR max
AMPS	CP0805A0836CW	824 - 849	14±1	0.5	1.4
	CP0805A0881CW	869 - 894	13.5±1		
GSM	CP0805A0902CW	890 - 915	13.5±1		
	CP0805A0947CW	935 - 960	13±1		
E-GSM	CP0805A0897CW	880 - 915	13.5±1		
	CP0805A0942CW	925 - 960	13±1		
PDC	CP0805A1441CW	1429 - 1453	9.5±1	1.15	1.8
PCN	CP0805A1747CW	1710 - 1785	8±1	1.6	2.2
	CP0805A1842CW	1805 - 1880	8±1	1.75	
PCS	CP0805A1880CW	1850 - 1910	7.5±1		
	CP0805A1960CW	1930 - 1990	7.5±1		
PHP	CP0805A1907CW	1895 - 1920	7.5±1		
DECT	CP0805A1890CW	1880 - 1900	7.5±1		
Wireless LAN	CP0805A2442CW	2400 - 2484	6±1	2.5	

Important: Couplers can be used at any frequency within the indicated range.



Thin-Film Directional Couplers



CP0805 Layout Types

3

LAYOUT

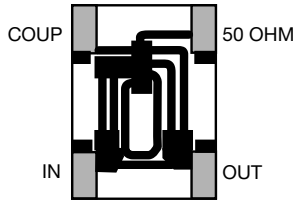

Type: A
Sub-Type: D

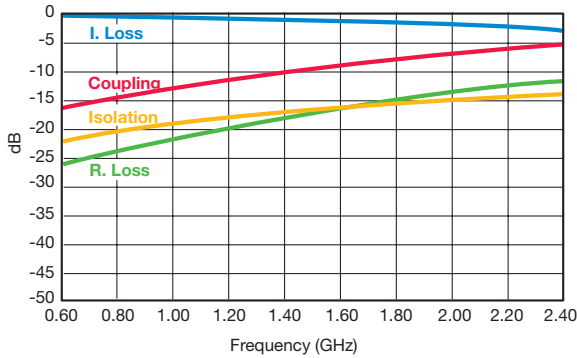

LAYOUT

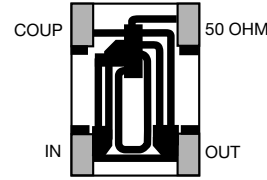

Type: A
Sub-Type: E

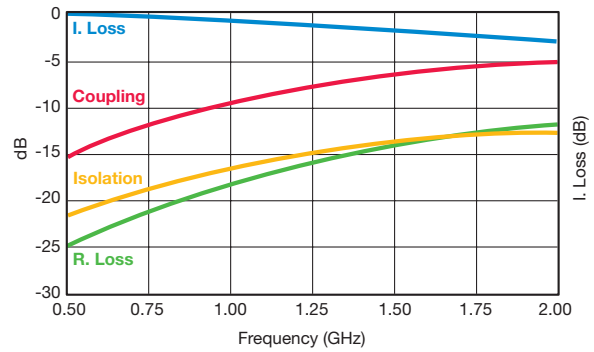

Application	P/N Examples	Frequency Band [MHz]	Coupling [dB]	I. Loss max	VSWR max
AMPS	CP0805A0836DW	824 - 849	13.0±1	0.5	1.4
	CP0805A0881DW	869 - 894	12.5±1		
GSM	CP0805A0902DW	890 - 915	12.5±1	0.5	1.4
	CP0805A0947DW	935 - 960	12±1		
E-GSM	CP0805A0897DW	880 - 915	12.5±1	0.5	1.4
	CP0805A0942DW	925 - 960	12±1		
PDC	CP0805A1441DW	1429 - 1453	8.5±1	1.25	1.8
PCN	CP0805A1747DW	1710 - 1785	7±1	1.85	2.1
	CP0805A1842DW	1805 - 1880	7±1		
PCS	CP0805A1880DW	1850 - 1910	7±1	2.15	2.1
	Cp0805A1960DW	1930 - 1990	6.5±1		
PHP	CP0805A1907DW	1895 - 1920	6.5±1	1.85	1.8
DECT	CP0805A1890DW	1880 - 1900	7±1	1.85	1.8
Wireless LAN	CP0805A2442DW	2400 - 2484	5.5±1	2.4	2.1

Application	P/N Examples	Frequency Band [MHz]	Coupling [dB]	I. Loss max	VSWR max
AMPS	CP0805A0836EW	824 - 849	11±1	0.85	1.4
	CP0805A0881EW	869 - 894	10.5±1		
GSM	CP0805A0902EW	890 - 915	10.5±1	0.85	1.4
	CP0805A0947EW	935 - 960	10±1		
E-GSM	CP0805A0897EW	880 - 915	10.5±1	0.85	1.4
	CP0805A0942EW	925 - 960	10±1		
PDC	CP0805A1441EW	1429 - 1453	7±1	1.8	1.8
PCN	CP0805A1747EW	1710 - 1785	5.5±1	2.7	2.2
	CP0805A1842EW	1805 - 1880	5.5±1		
PCS	CP0805A1880EW	1850 - 1910	5±1	3.15	2.4
	Cp0805A1960EW	1930 - 1990	5±1		
PHP	CP0805A1907EW	1895 - 1920	5±1	3.15	2.4
DECT	CP0805A1890EW	1880 - 1900	5±1	3.15	2.4
Wireless LAN	CP0805A2442EW	2400 - 2484	4±1	4.2	2.4

Type: B
Sub-Type: A

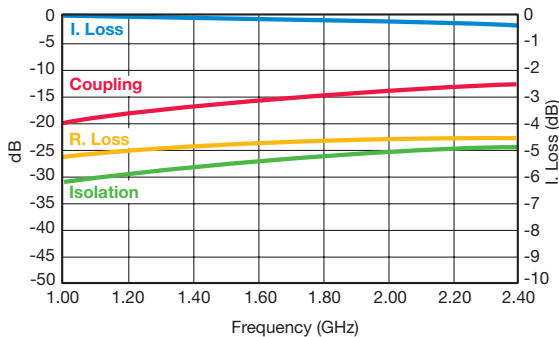

LAYOUT

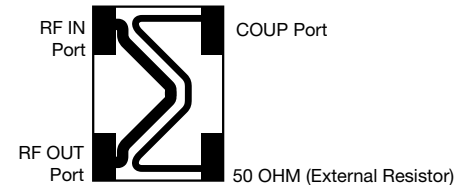

Application	P/N Examples	Frequency Band [MHz]	Coupling [dB]	I. Loss max	VSWR max
AMPS	CP0805B0836AW	824 - 849	21.5±1	0.25	1.2
	CP0805B0881AW	869 - 894	21±1		
GSM	CP0805B0902AW	890 - 915	21±1	0.25	1.2
	CP0805B0947AW	935 - 960	20.5±1		
E-GSM	CP0805B0897AW	880 - 915	21±1	0.25	1.2
	CP0805B0942AW	925 - 960	20.5±1		
PDC	CP0805B1441AW	1429 - 1453	17±1	0.3	1.2
PCN	CP0805B1747AW	1710 - 1785	15.5±1	0.3	1.2
	Cp0805B1842AW	1805 - 1880	15.5±1		
PCS	CP0805B1880AW	1850 - 1910	15±1	0.3	1.2
	CP0805B1960AW	1930 - 1990	14.5±1		
PHP	CP0805B1907AW	1895 - 1920	15±1	0.3	1.2
DECT	CP0805B1890AW	1880 - 1900	15±1	0.3	1.2
Wireless LAN	CP0805B2442AW	2400 - 2484	13±1	0.4	1.2

Important: Couplers can be used at any frequency within the indicated range.



Thin-Film Directional Couplers



CP0805 Layout Types

LAYOUT

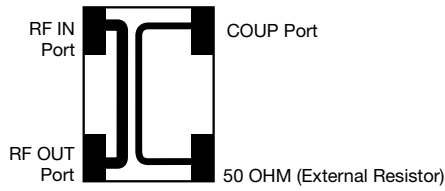

Type: B
Sub-Type: B

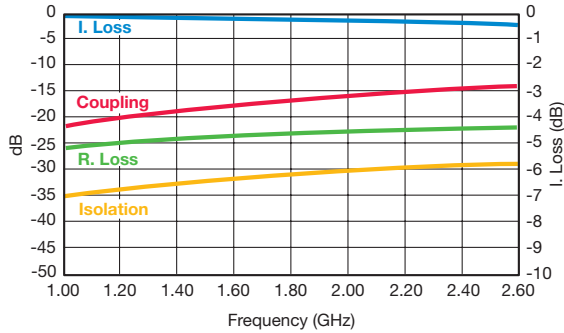

LAYOUT

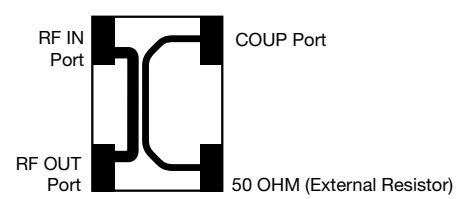

Type: B
Sub-Type: C

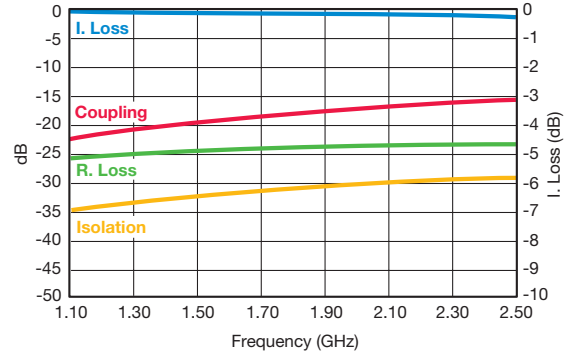

Application	P/N Examples	Frequency Band [MHz]	Coupling [dB]	I. Loss max	VSWR max
AMPS	CP0805B0836BW	824 - 849	23.5±1	0.25	1.2
	CP0805B0881BW	869 - 894	23±1		
GSM	CP0805B0902BW	890 - 915	22.5±1		
	CP0805B0947BW	935 - 960	22±1		
E-GSM	CP0805B0897BW	880 - 915	23±1		
	CP0805B0942BW	925 - 960	22±1		
PDC	CP0805B1441BW	1429 - 1453	18.5±1		
PCN	CP0805B1747BW	1710 - 1785	17±1		
	CP0805B1842BW	1805 - 1880	16.5±1		
PCS	CP0805B1880BW	1850 - 1910	16.5±1		
	CP0805B1960BW	1930 - 1990	16±1		
PHP	CP0805B1907BW	1895 - 1920	16±1		
DECT	CP0805B1890BW	1880 - 1900	16±1		
Wireless LAN	CP0805B2442BW	2400 - 2484	14±1	0.4	

Application	P/N Examples	Frequency Band [MHz]	Coupling [dB]	I. Loss max	VSWR max
AMPS	CP0805B0836CW	824 - 849	25±1	0.25	1.2
	CP0805B0881CW	869 - 894	24.5±1		
GSM	CP0805B0902CW	890 - 915	24±1		
	CP0805B0947CW	935 - 960	24±1		
E-GSM	CP0805B0897CW	880 - 915	24.5±1		
	CP0805B0942CW	925 - 960	24±1		
PDC	CP0805B1441CW	1429 - 1453	20±1		
PCN	CP0805B1747CW	1710 - 1785	18.5±1		
	CP0805B1842CW	1805 - 1880	18.5±1		
PCS	CP0805B1880CW	1850 - 1910	18±1		
	CP0805B1960CW	1930 - 1990	17.5±1		
PHP	CP0805B1907CW	1895 - 1920	18±1		
DECT	CP0805B1890CW	1880 - 1900	18±1		
Wireless LAN	CP0805B2442CW	2400 - 2484	16±1	0.4	

3

Important: Couplers can be used at any frequency within the indicated range.



Thin-Film Directional Couplers



CP0805 and CP0603 Test Jig

ITF TEST JIG FOR COUPLER TYPES 0805 AND 0603 SMD

GENERAL DESCRIPTION

This jig is designed for the testing of CP0805 and CP0603 series Directional Couplers using a vector network analyzer. It consists of a FR4 multi-layer substrate, having 50Ω microstrips as conducting lines and a ground plane in the middle layer, located at a distance of 0.2mm from the microstrips.

The connectors are SMA type (female), 'Johnson Components Inc.' Product P/N: 142-0701-881.

The jig is designed for a full 2-port calibration. LOAD calibration can be done either by a 50Ω SMA termination, or by soldering a 50Ω chip resistor at the 50Ω ports.

MEASUREMENT PROCEDURE

When measuring a component, it can be either soldered or pressed by a non-metallic stick until all four ports touch the appropriate pads. To measure the coupling (and the R. Loss) place the component on the Port 1 & Port 2 pads. Use two SMA 50Ω terminations (male) to terminate the ports, which are not connected to the network analyzer, and connect the network analyzer to the two ports. A 90° rotation of the component on its pads allows measuring a second parameter (I. Loss).

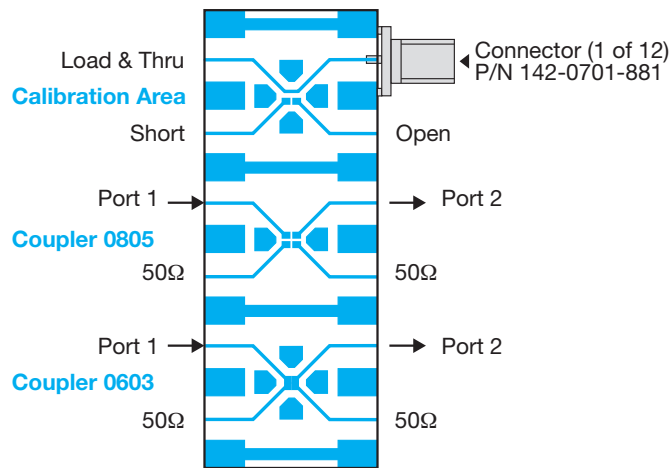

CP0805 SERIES DIRECTIONAL COUPLERS

Orientation and Tape and Reel Packaging Specification

(Top View)

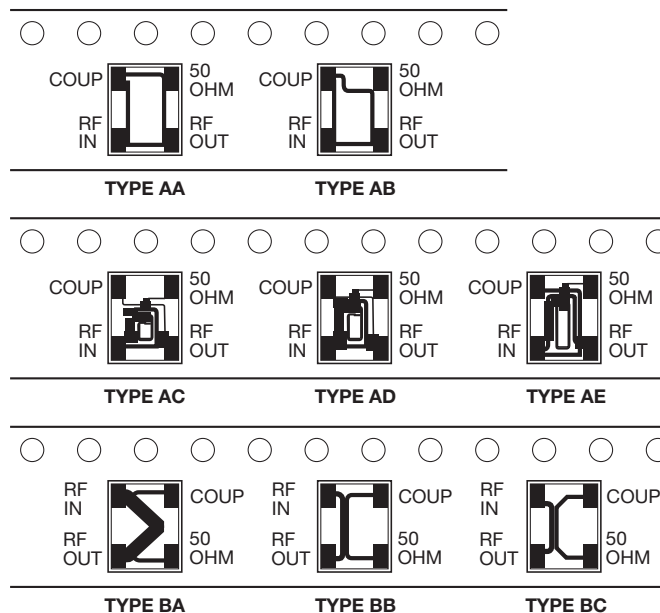

The parts should be mounted on the PCB with White (Alumina) side down and the "dark" side up.

3



Thin-Film Directional Couplers

DB0805 3dB 90° Couplers



GENERAL DESCRIPTION ITF TECHNOLOGY

The ITF SMD 3dB 90° Coupler is based on thin-film multilayer technology. The technology provides a miniature part with excellent high frequency performance and rugged construction for reliable automatic assembly.

The ITF 3dB 90° Coupler is offered in a variety of frequency bands compatible with various types of high frequency wireless systems.

Recommended Pad Layout Dimensions mm (inches)

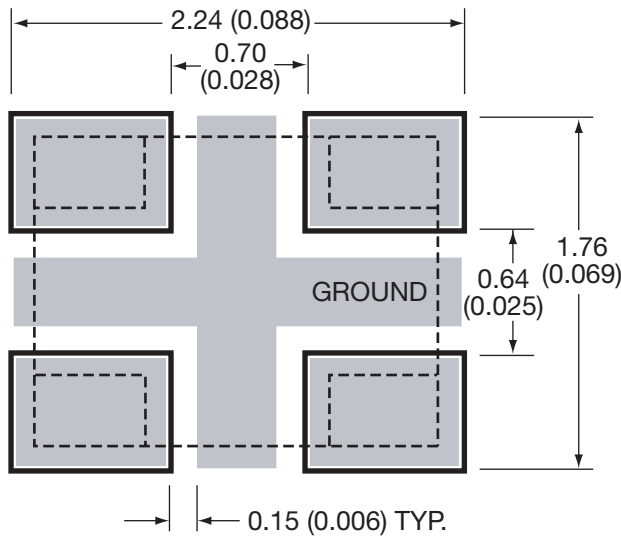

APPLICATIONS

- Balanced Amplifiers and Signal Distribution in Mobile Communications

FEATURES

- Miniature 0805 size
- Low I. Loss
- High Isolation
- Power Handling: 10W RF CW
- Surface Mountable
- Supplied on Tape and Reel
- Operating Temperature -40°C to +85°C

DIMENSIONS:

millimeters (inches)

L	2.03±0.10 (0.080±0.004)
W	1.55±0.10 (0.061±0.004)
T	0.98±0.15 (0.037±0.006)
A	0.56±0.25 (0.022±0.010)
B	0.35±0.15 (0.014±0.006)

Bottom View

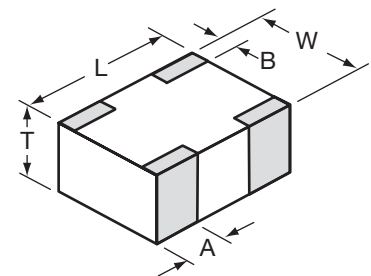

TERMINALS (Top View) Orientation in Tape

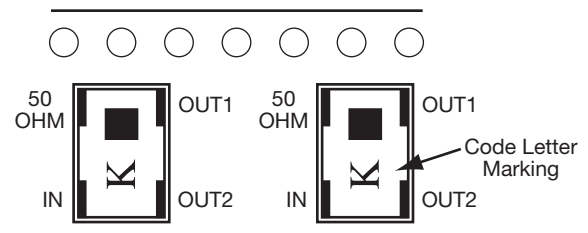

ELECTRICAL PARAMETERS*

Part Number	Frequency F ₀ [MHz]	I. Loss @ F ₀ [dB]	Phase Balance [deg] max.	Code Letter Marking
DB0805A0880AWTR	880±30	0.35	3	Y
DB0805A0915AWTR	915±30	0.35	3	V
DB0805A0967AWTR	967±30	0.35	3	V
DB0805A1350AWTR	1350±50	0.35	3	C
DB0805A1650AWTR	1650±50	0.35	3	F
DB0805A1800AWTR	1800±50	0.30	3	F
DB0805A1850AWTR	1850±50	0.30	3	K
DB0805A1900AWTR	1900±50	0.30	3	K
DB0805A1950AWTR	1950±50	0.25	3	K
DB0805A2140AWTR	2140±50	0.25	3	L
DB0805A2325AWTR	2325±50	0.25	3	T

*With Recommended Pad Layout

Important: All intermediate frequencies within the indicated range are readily available.

Thin-Film Directional Couplers

DB0805 3dB 90° Couplers



880 ± 30MHz DB0805A0880AWTR

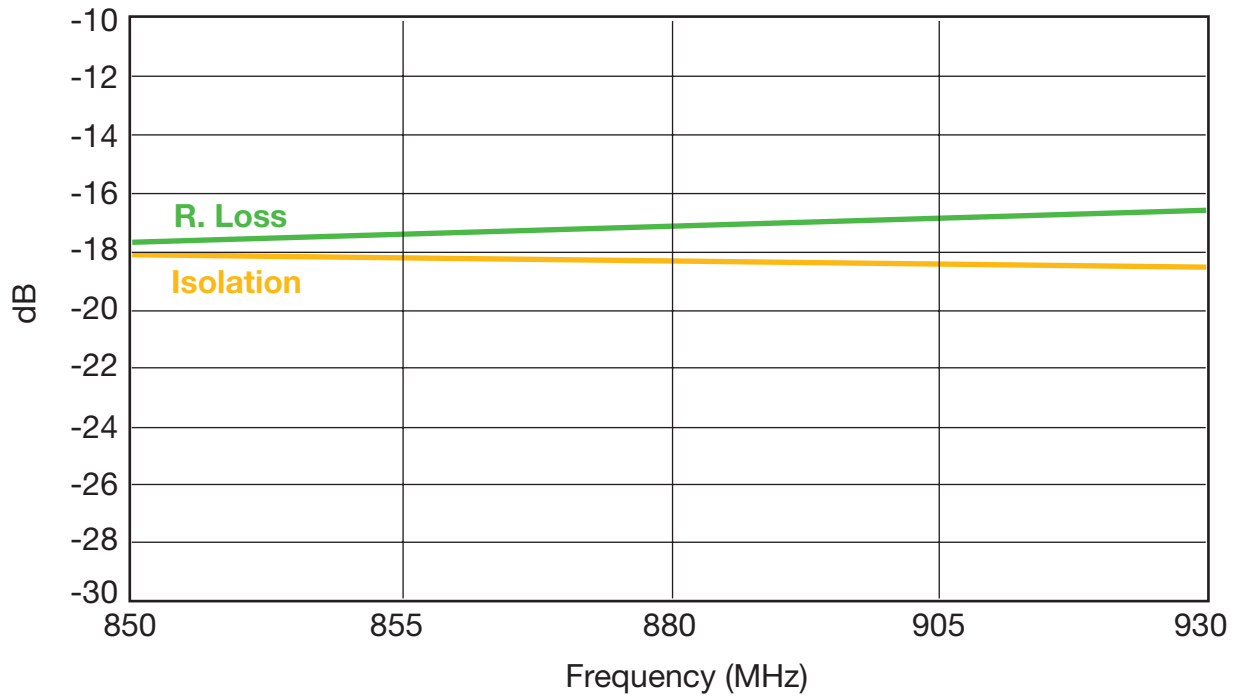
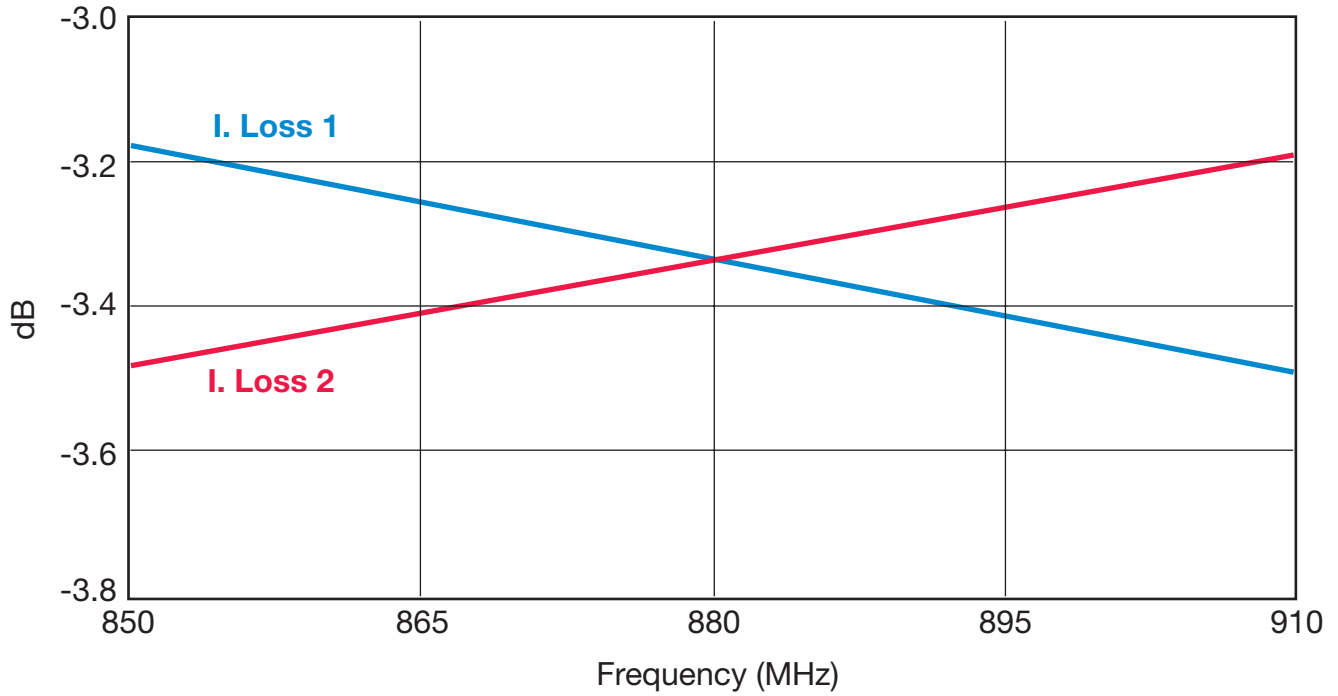

3



Thin-Film Directional Couplers

DB0805 3dB 90° Couplers



915 ± 30MHz DB0805A0915AWTR

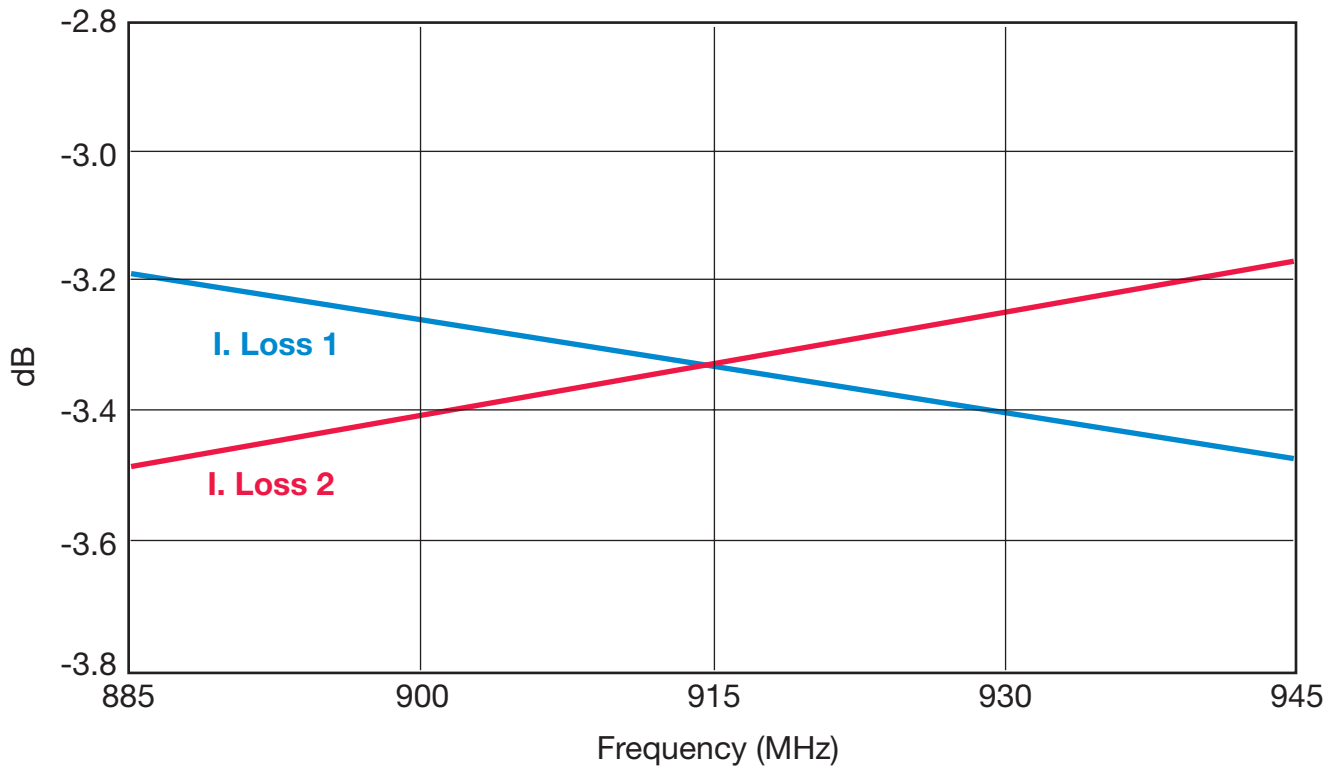

3

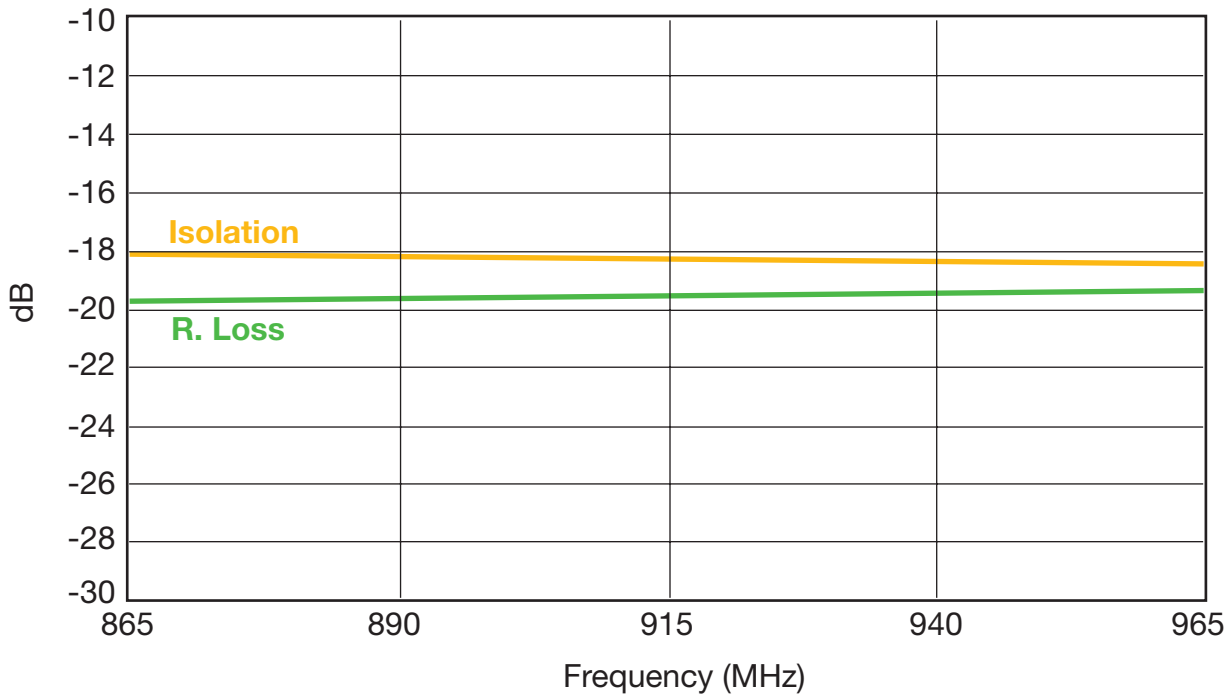

Thin-Film Directional Couplers

DB0805 3dB 90° Couplers



967± 30MHz DB0805A0967AWTR

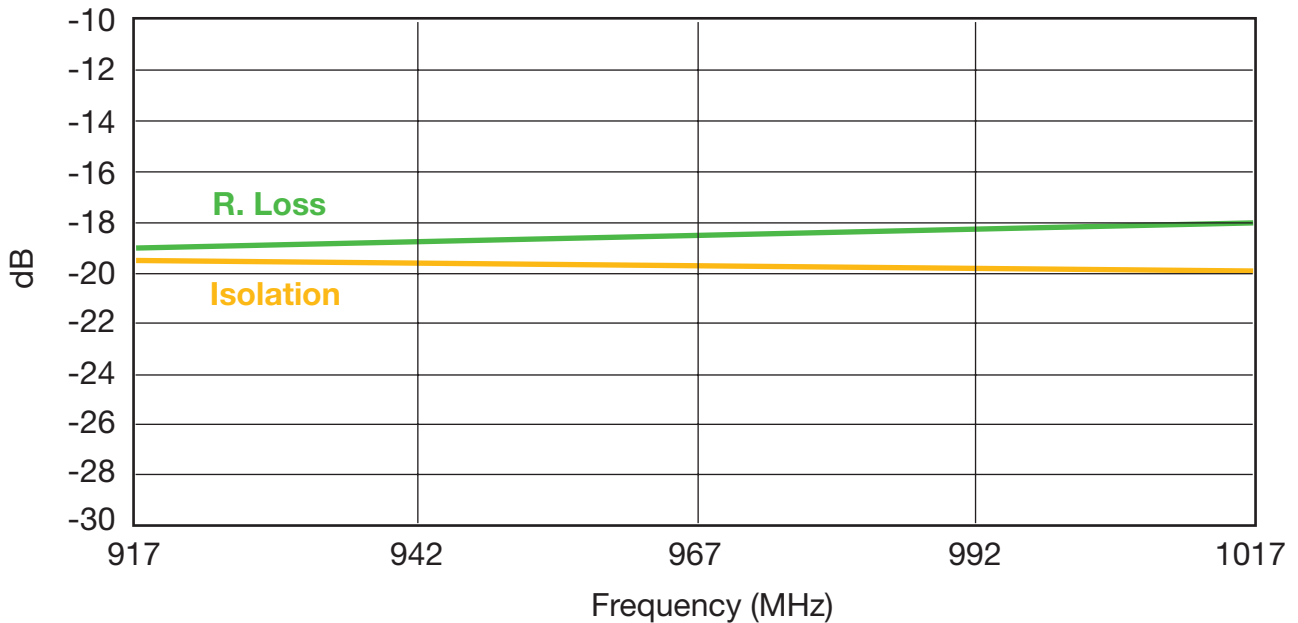
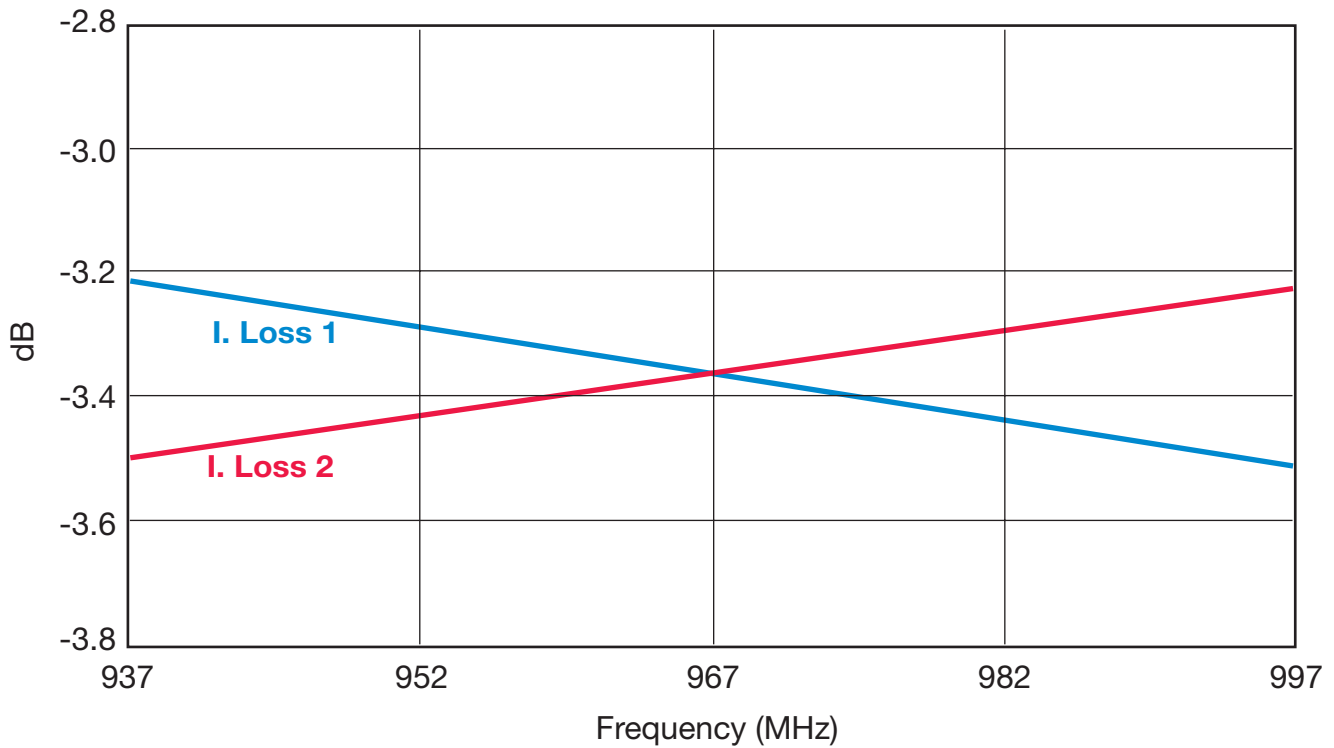

3



Thin-Film Directional Couplers

DB0805 3dB 90° Couplers



1350 ± 50MHz DB0805A1350AWTR

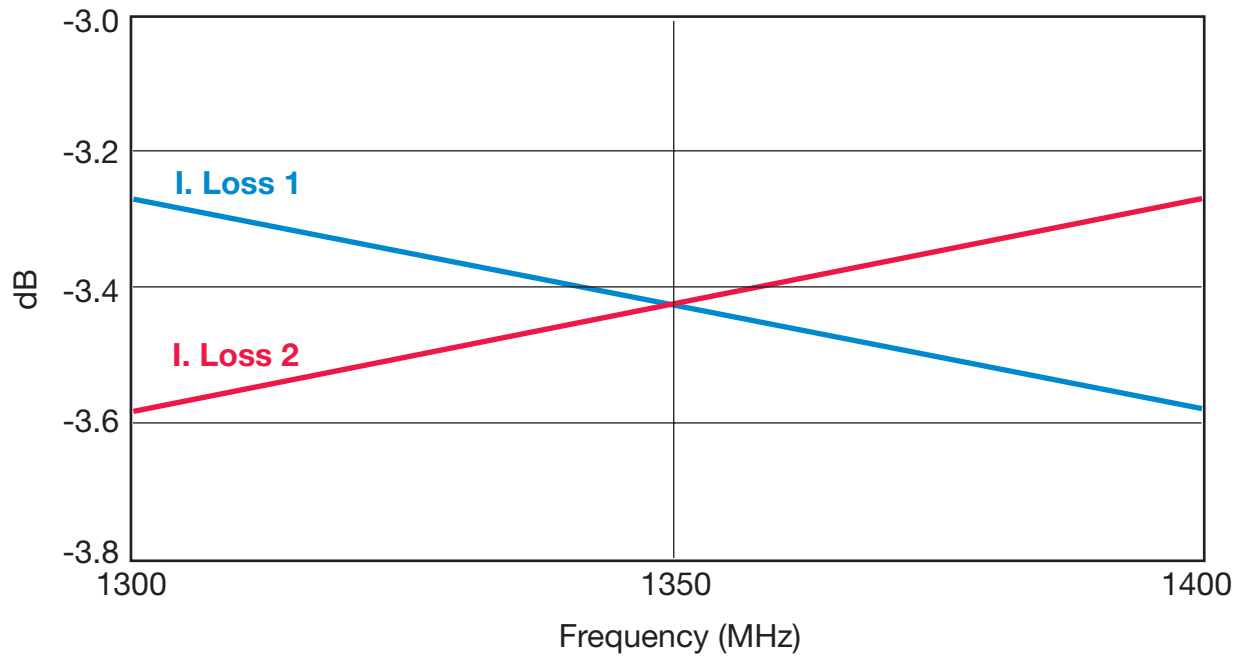

3

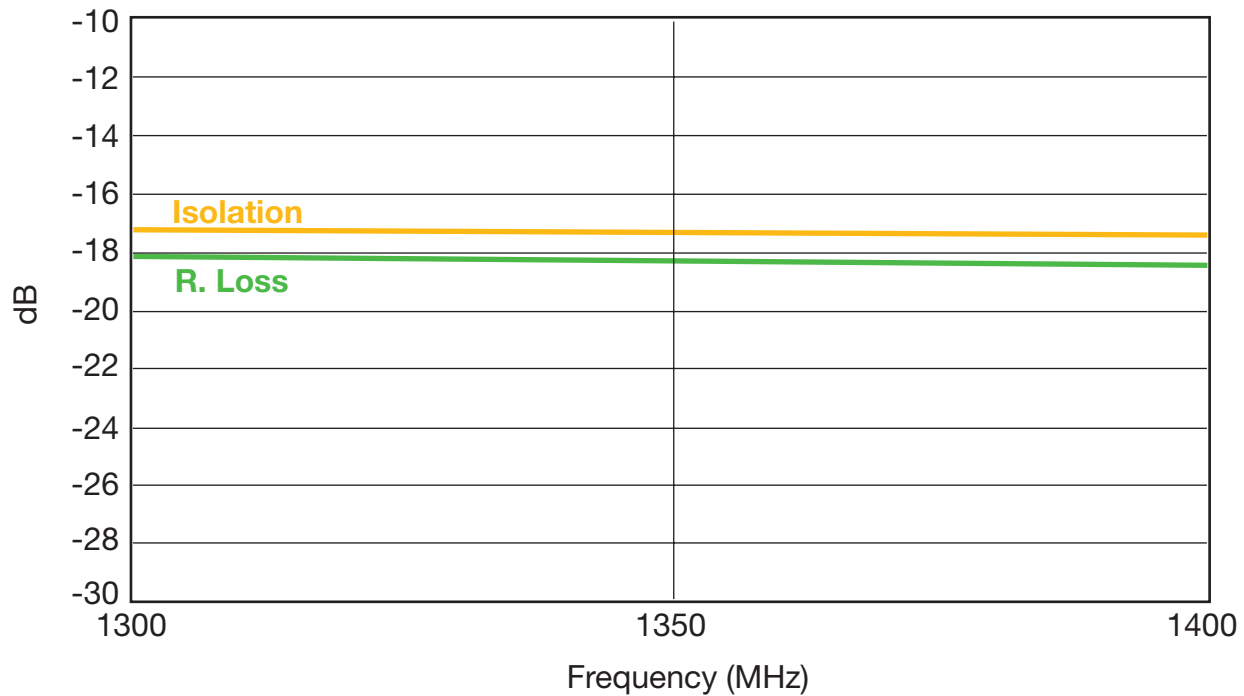

Thin-Film Directional Couplers

DB0805 3dB 90° Couplers



1650 ± 50MHz DB0805A1650AWTR

3

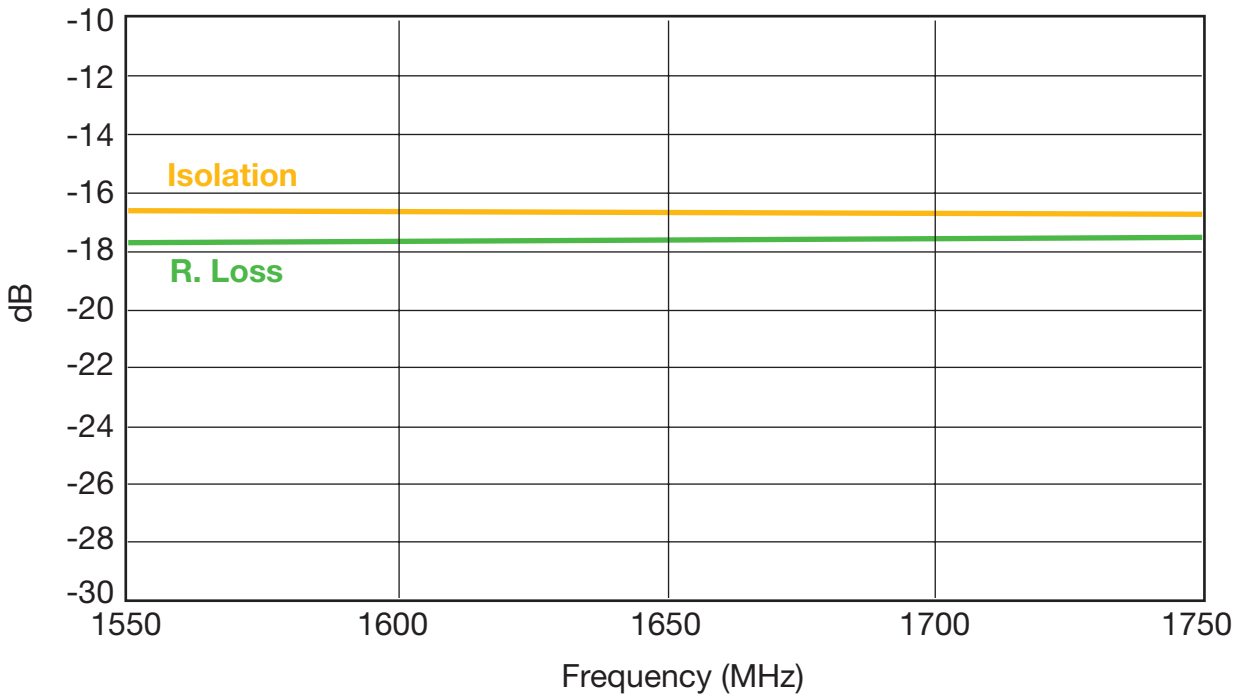
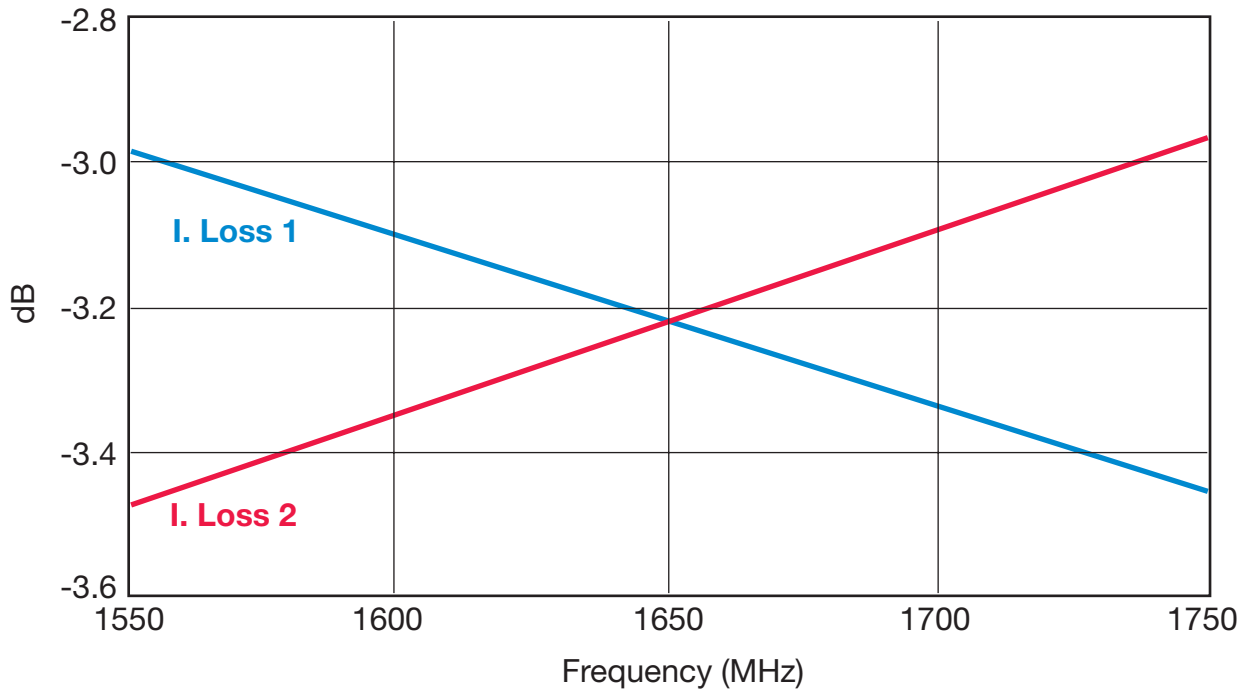

Thin-Film Directional Couplers

DB0805 3dB 90° Couplers



1800 ± 50MHz DB0805A1800AWTR

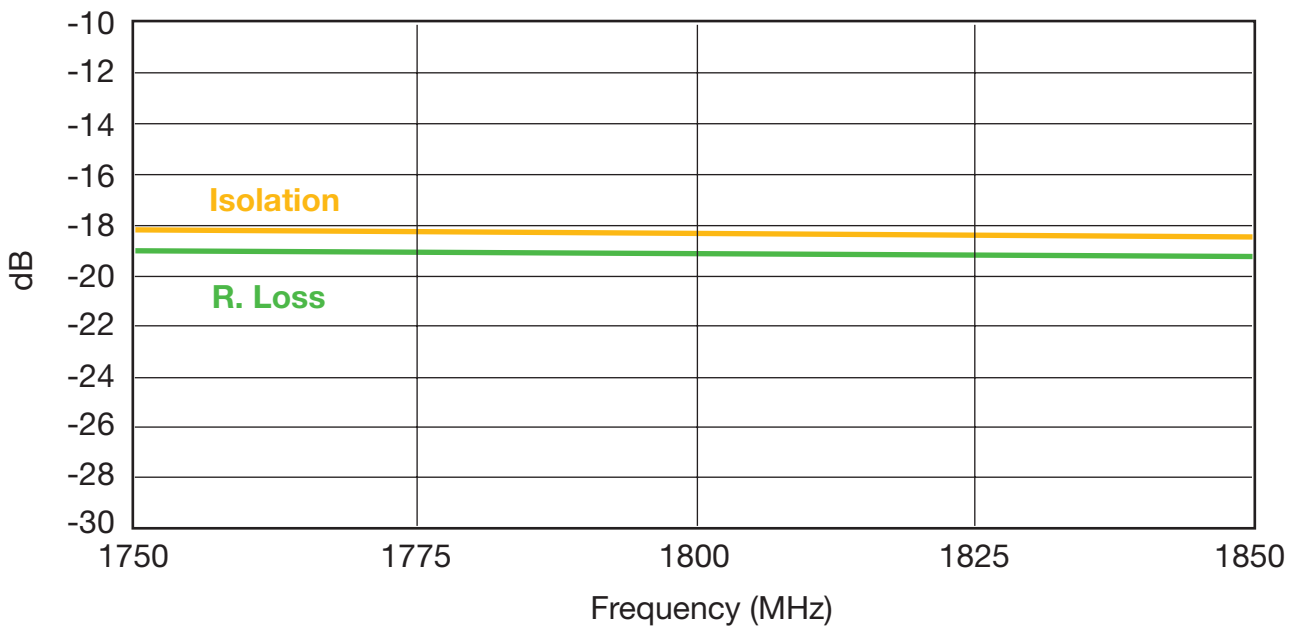
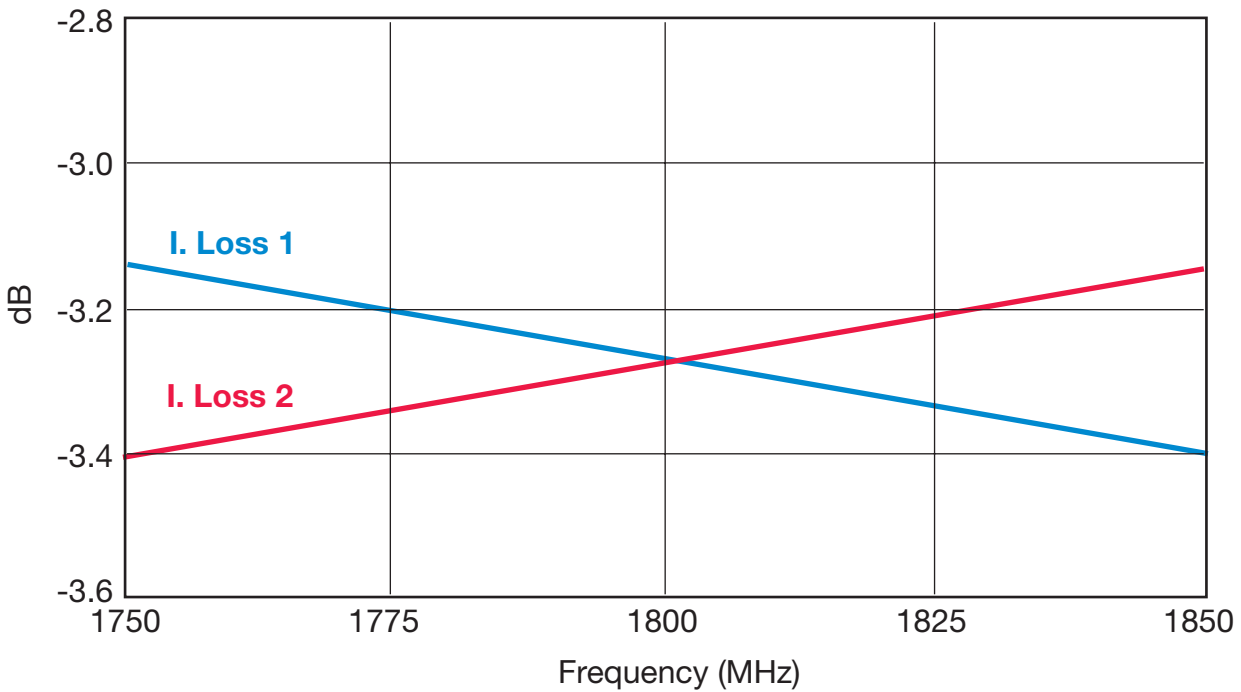

3

Thin-Film Directional Couplers

DB0805 3dB 90° Couplers



1850 ± 50MHz DB0805A1850AWTR

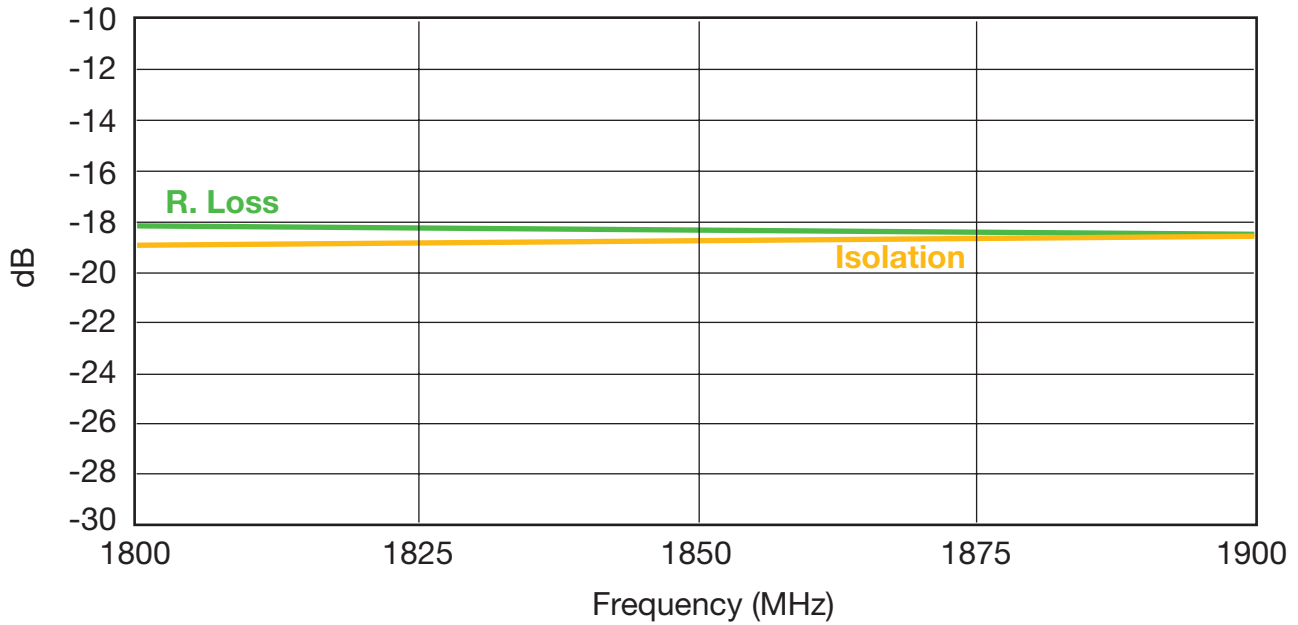
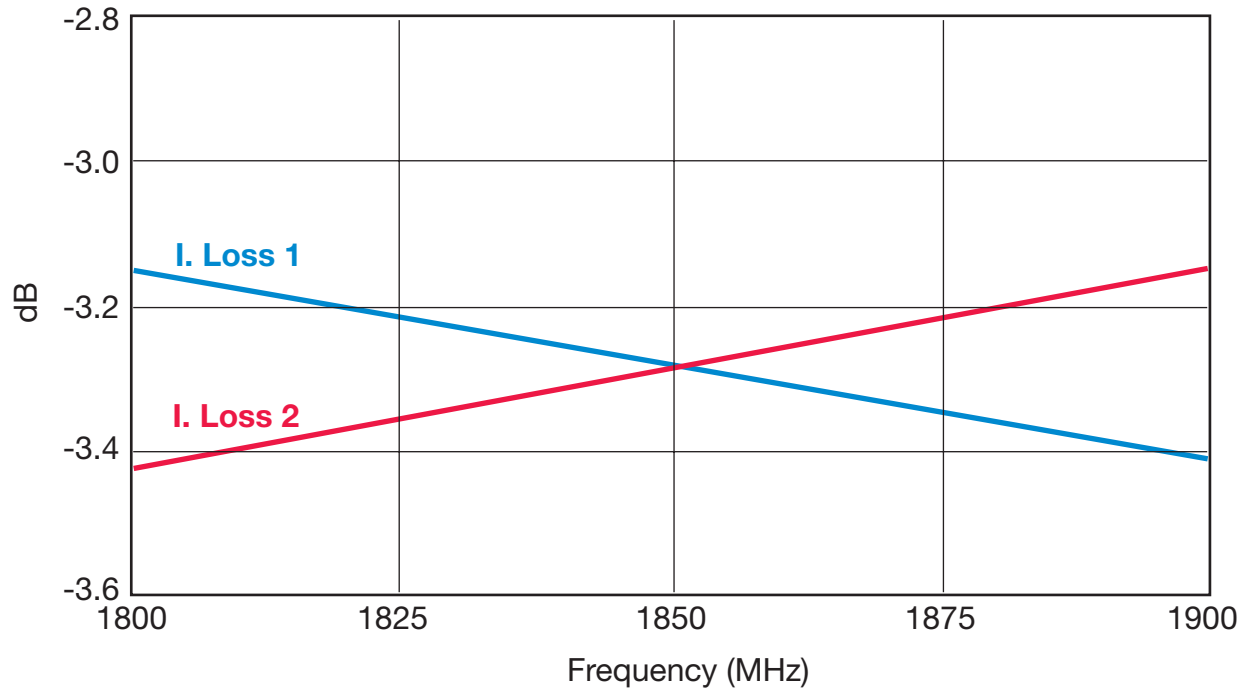

3



Thin-Film Directional Couplers

DB0805 3dB 90° Couplers



1900 ± 50MHz DB0805A1900AWTR

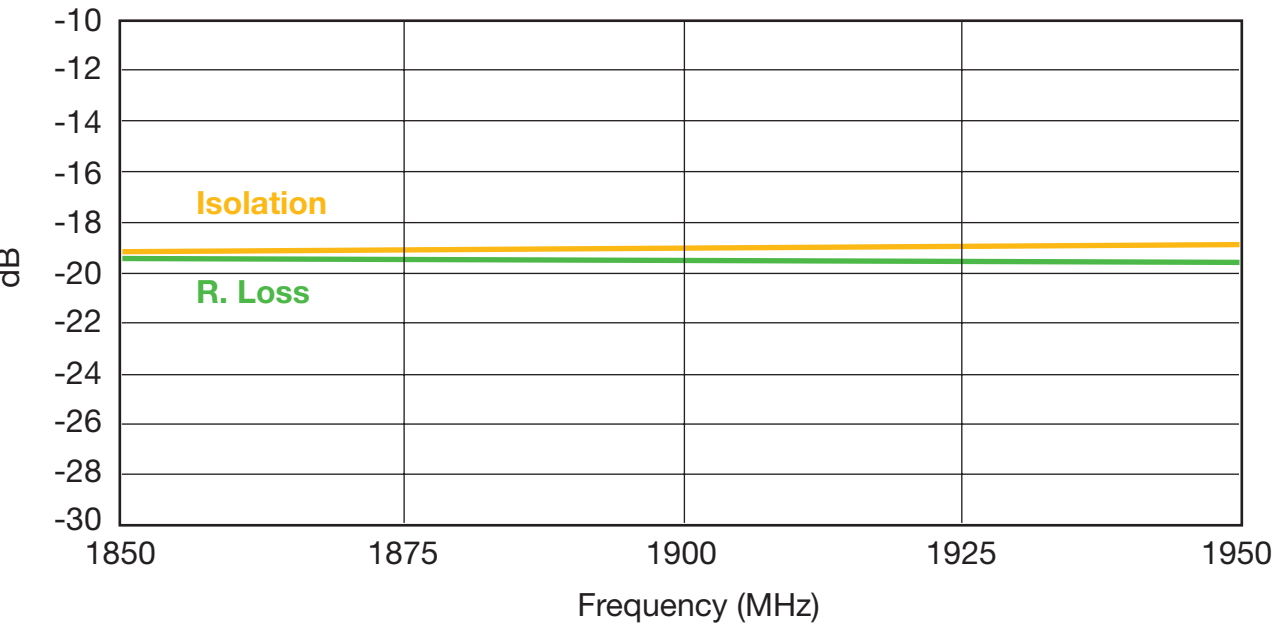
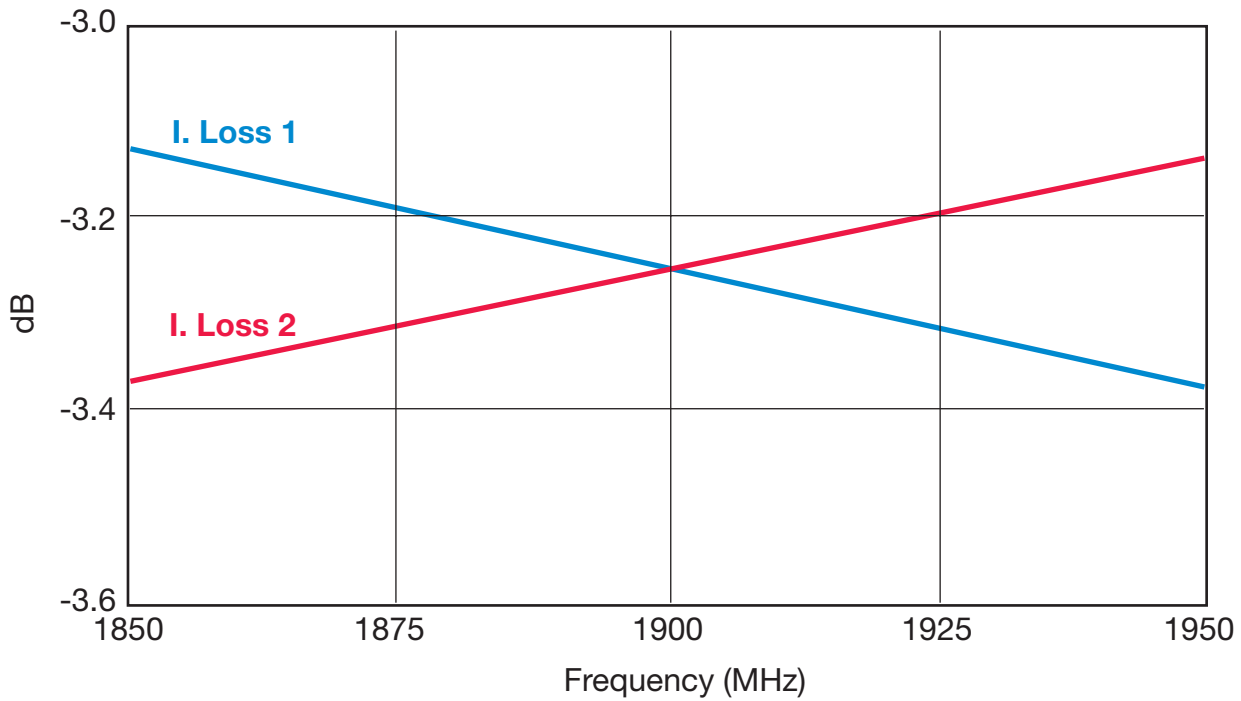

3

Thin-Film Directional Couplers

DB0805 3dB 90° Couplers



1950 ± 50MHz DB0805A1950AWTR

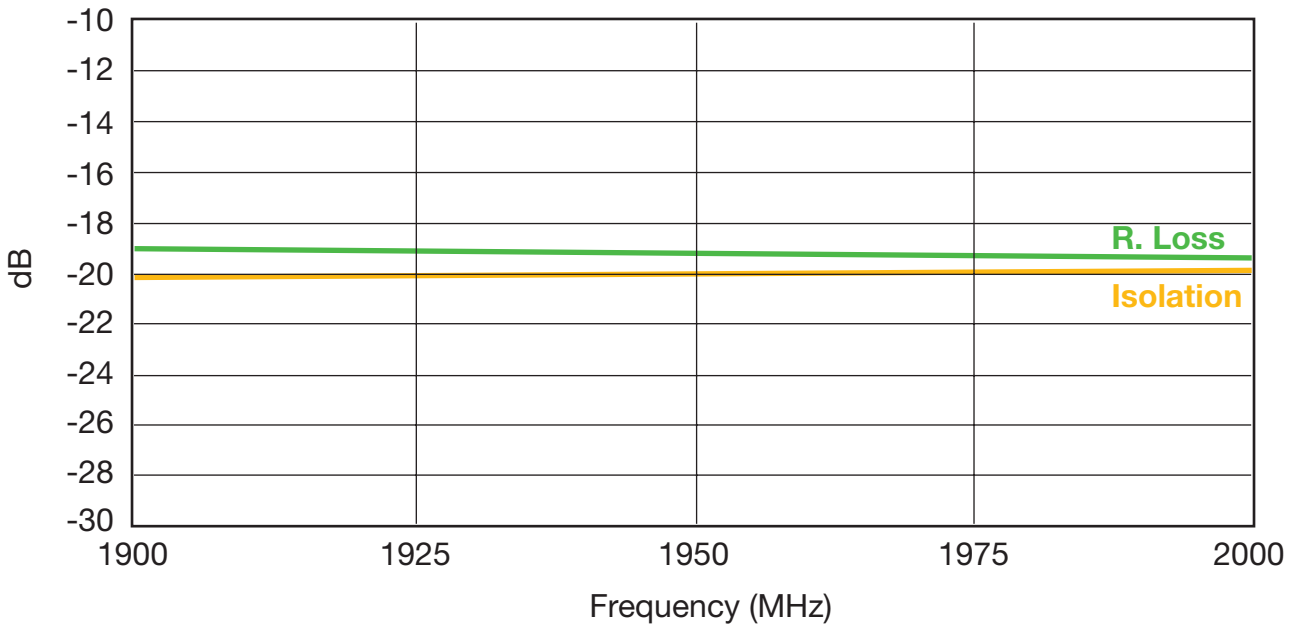
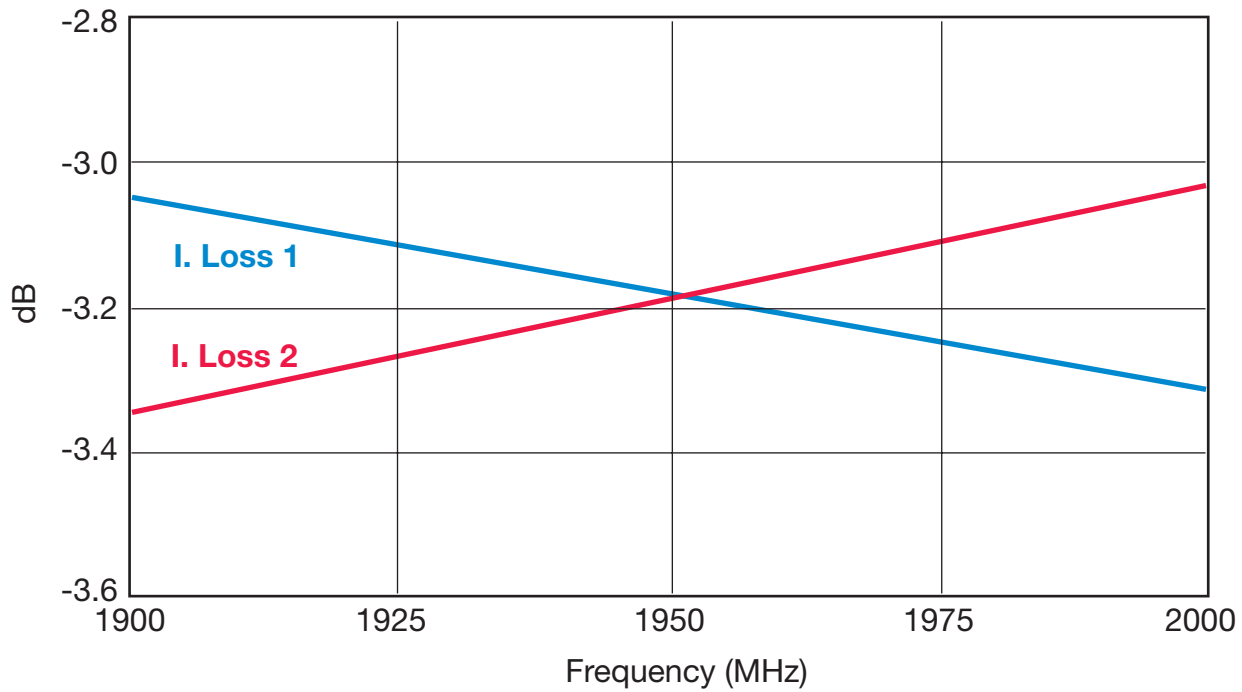

3



Thin-Film Directional Couplers

DB0805 3dB 90° Couplers



2140 ± 50MHz DB0805A2140AWTR

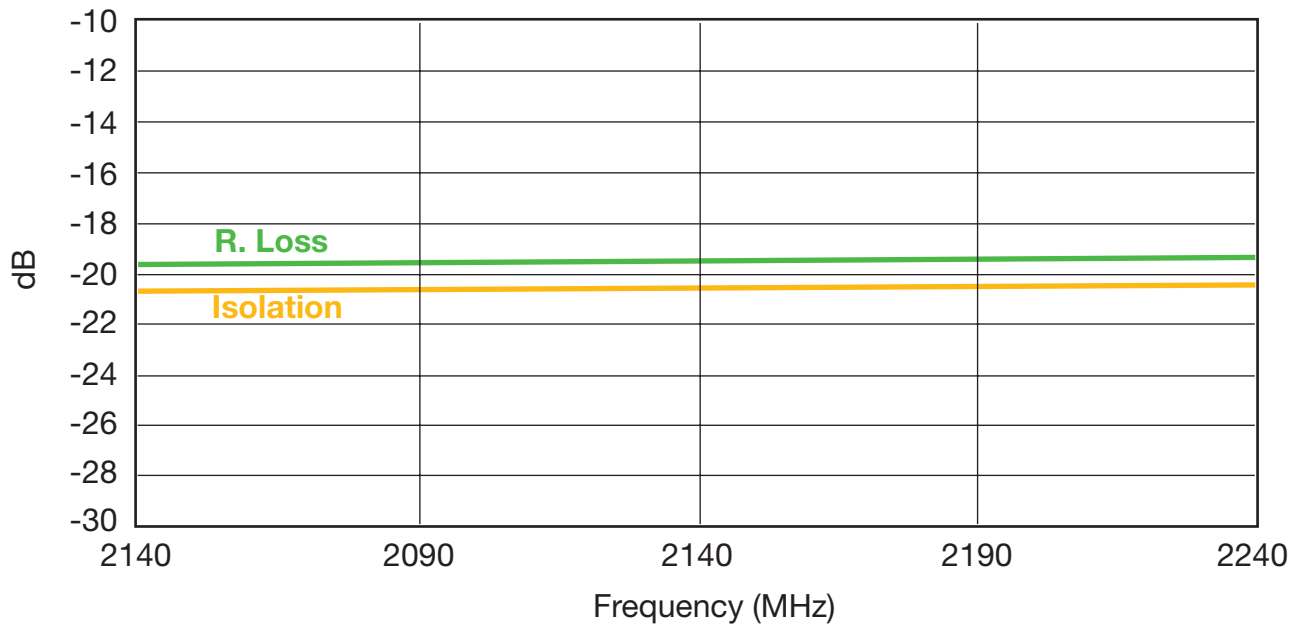
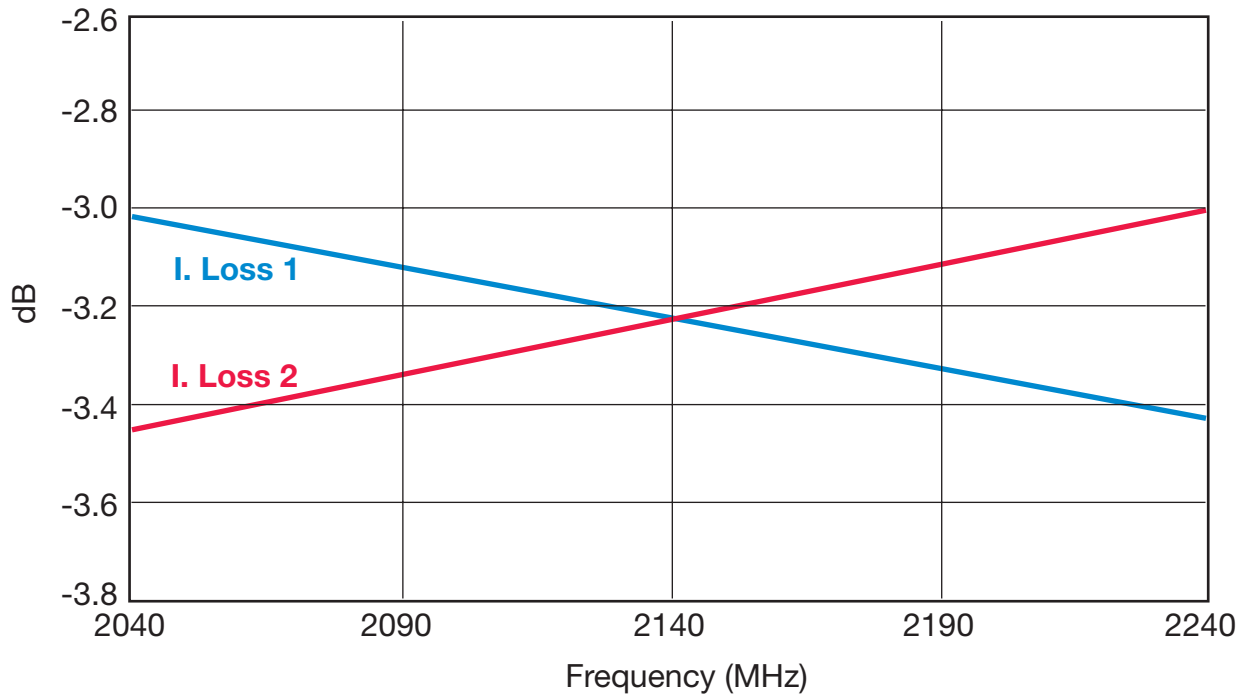

3

Thin-Film Directional Couplers

DB0805 3dB 90° Couplers



2325 ± 50MHz DB0805A2325AWTR

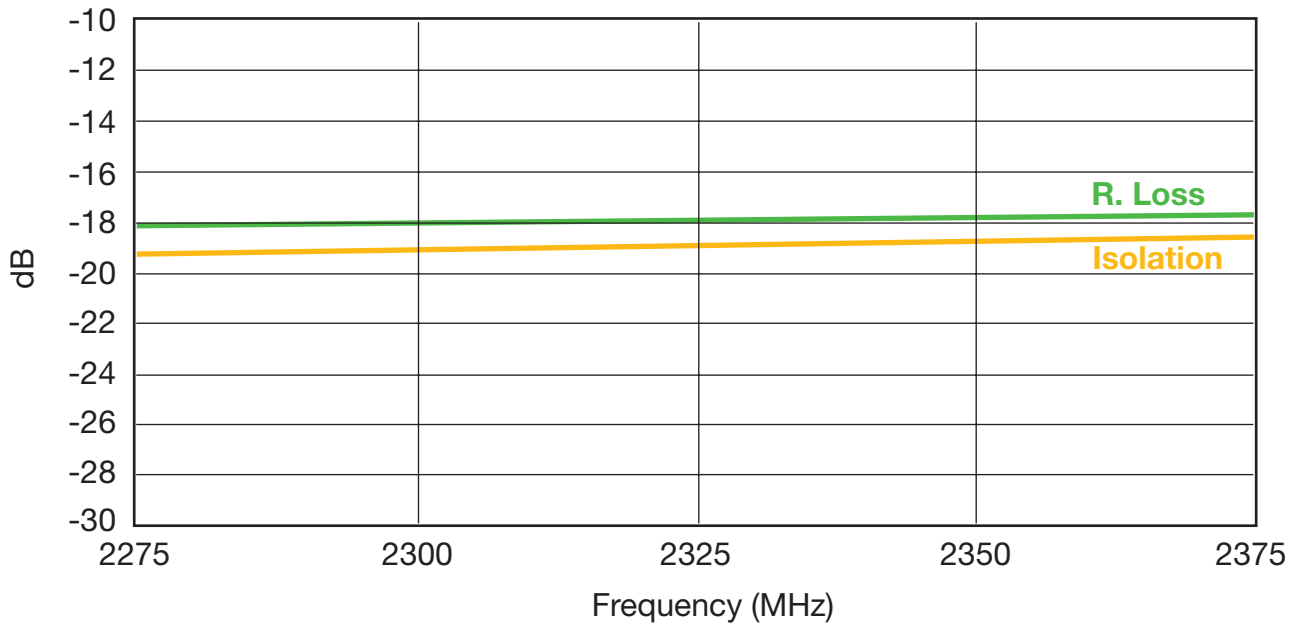
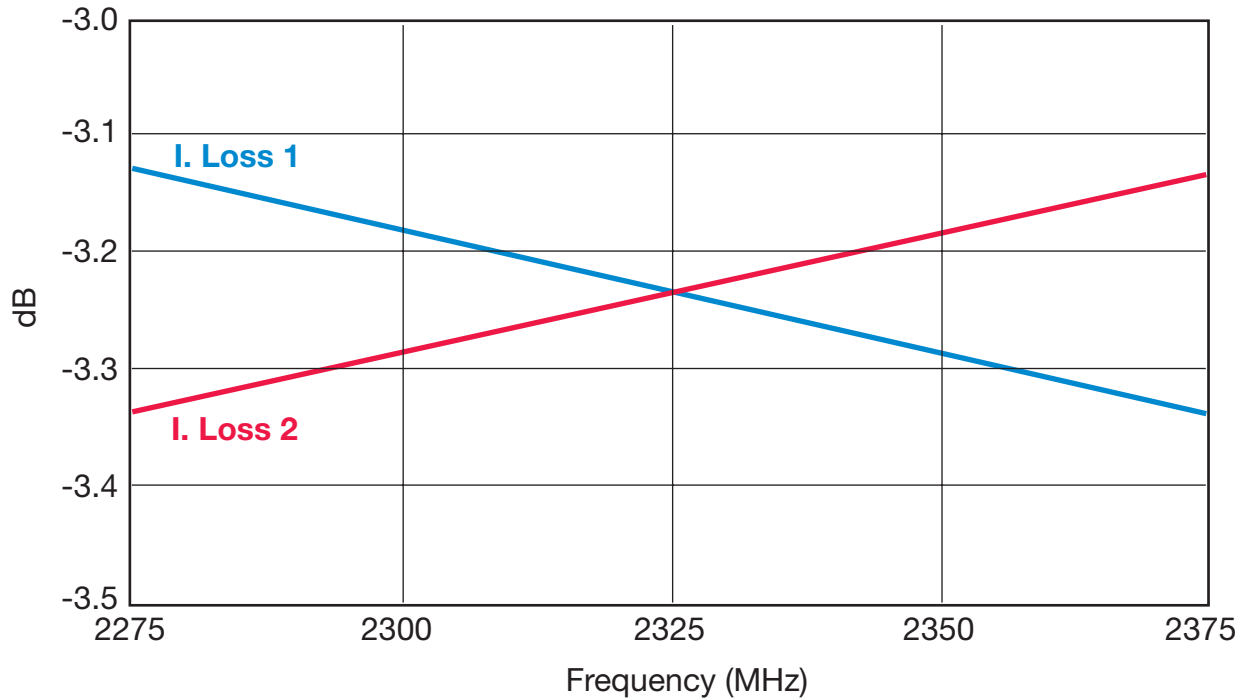

3



Thin-Film Directional Couplers



DB0805 3dB 90° Test Jigs

GENERAL DESCRIPTION

These jigs are designed for testing the DB0805 3dB 90° Couplers using a Vector Network Analyzer.

They consist of a dielectric substrate, having 50Ω microstrips as conducting lines and a bottom ground plane located at a distance of 0.254mm from the microstrips.

The substrate used is Neltec's NH9338ST0254C1BC.

The connectors are SMA type (female), 'Johnson Components Inc.' Product P/N: 142-0701-841.

Both a measurement jig and a calibration jig are provided.

The calibration jig is designed for a full 2-port calibration, and consists of an open line, short line and through line. LOAD calibration can be done by a 50Ω SMA termination.

MEASUREMENT PROCEDURE

When measuring a component, it can be either soldered or pressed using a non-metallic stick until all four ports touch the appropriate pads. Set the VNA to the relevant frequency band. Connect the VNA using a 10dB attenuator on the jig

terminal connected to port 2. Follow the VNA's instruction manual and use the [calibration jig](#) to perform a full 2-port calibration in the required bandwidths.

3

Place the coupler on the **measurement jig** as follows:

Input (Coupler) → Connector 1 (Jig) Output 1 (Coupler) → Connector 3 (Jig)
50Ω (Coupler) → Connector 2 (Jig) Output 2 (Coupler) → Connector 4 (Jig)

To measure **R. Loss** and **I. Loss 1** connect:

Connector 1 (Jig) → Port 1 (VNA) Connector 3 (Jig) → Port 2 (VNA)
Connector 2 (Jig) → 50Ω Connector 4 (Jig) → 50Ω

To measure **R. Loss** and **I. Loss 2** connect:

Connector 1 (Jig) → Port 1 (VNA) Connector 3 (Jig) → 50Ω
Connector 2 (Jig) → 50Ω Connector 4 (Jig) → Port 2 (VNA)

To measure **Isolation** connect:

Connector 1 (Jig) → 50Ω Connector 3 (Jig) → Port 1 (VNA)
Connector 2 (Jig) → 50Ω Connector 4 (Jig) → Port 2 (VNA)

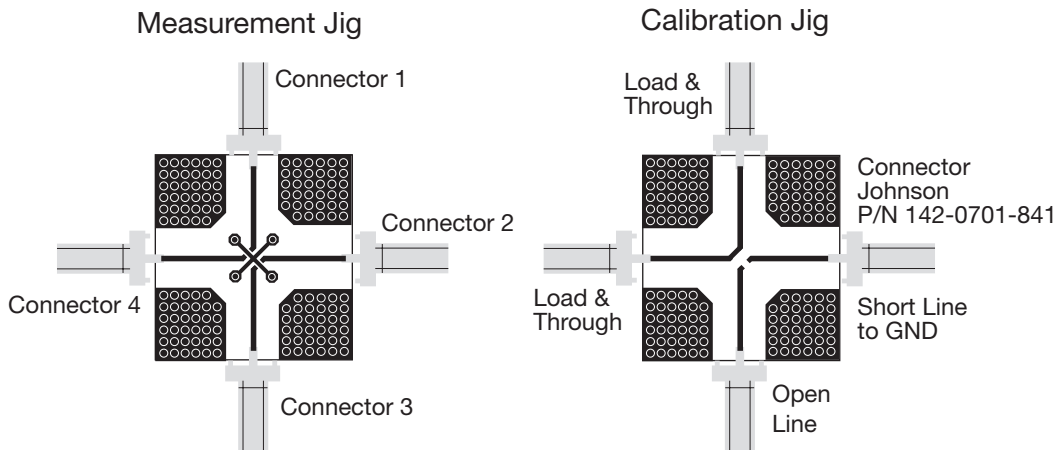



Thin-Film Technology

Integrated Thin-Film
Low-Pass Filters

4



Thin-Film Low Pass Filter

LP0603 Lead-Free LGA Type

GENERAL DESCRIPTION

The LP0603 ITF (Integrated Thin Film) Lead-Free LGA Low Pass Filter is based on thin-film multilayer technology. The technology provides a miniature part with excellent high frequency performance and rugged construction for reliable automatic assembly.

The ITF Low Pass Filters are offered in a variety of frequency bands compatible with various types of high frequency wireless systems.

FEATURES

- Miniature Size: 0603
- Frequency Range: 900MHz -2.4GHz
- Characteristic Impedance: 50 Ohm
- Operating/Storage Temperature: -40°C to +85°C
- Power Rating: 3W Continuous
- Low Profile
- Rugged Construction
- Lead Free
- Taped and Reeled

APPLICATIONS

- Mobile communications
- Satellite TV receivers
- GPS
- Vehicle location systems
- Wireless LANs
- RFID

LAND GRID ARRAY ADVANTAGES

- Inherent Low Profile
- Self Alignment during Reflow
- Excellent Solderability
- Low Parasitics
- Better Heat Dissipation

HOW TO ORDER

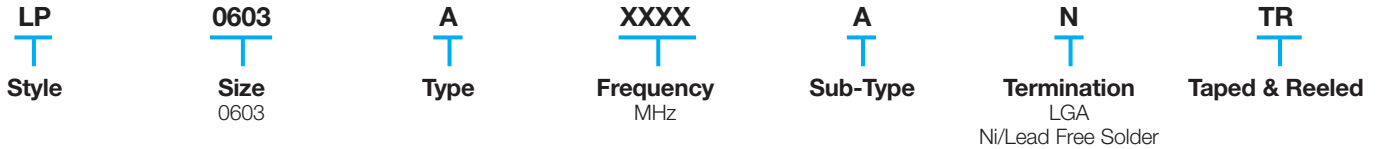

FINAL QUALITY INSPECTION

Finished parts are 100% tested for electrical parameters and visual characteristics. Each production lot is evaluated on a sample basis for:

- Static Humidity: 85°C, 85% RH, 160 hours
- Endurance: 125°C, IR, 4 hours

TERMINATION

Nickel/Lead-Free Solder coating compatible with automatic soldering technologies: reflow, wave soldering, vapor phase and manual.

Thin-Film Low Pass Filter



LP0603 Lead-Free LGA Type

DIMENSIONS: millimeters (inches) (Bottom View)

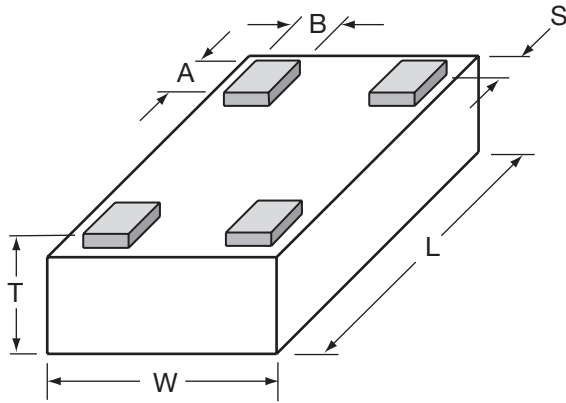

L	1.6±0.1 (0.063±0.004)	A	0.25±0.05 (0.010±0.002)
W	0.84±0.1 (0.033±0.004)	B	0.20±0.05 (0.008±0.002)
T	0.60±0.1 (0.024±0.004)	S	0.05±0.05 (0.002±0.002)

TERMINALS AND ORIENTATION IN TAPE (Top View)

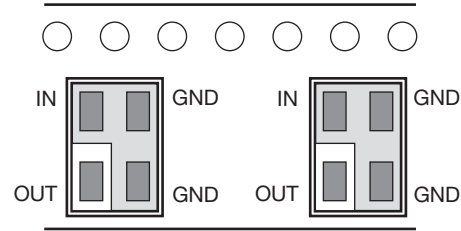

RECOMMENDED PAD LAYOUT (mm)

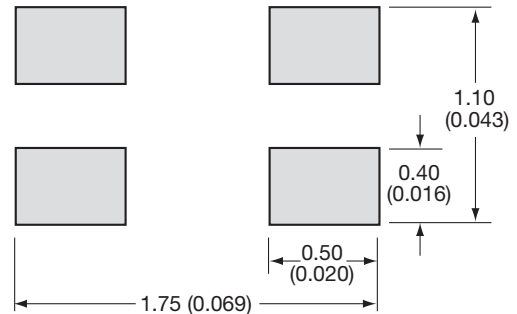

4

ELECTRICAL CHARACTERISTICS

(Guaranteed over -40°C to $+85^{\circ}\text{C}$ Operating Temperature Range)

P/N	Frequency Band [MHz]	I. Loss [dB]	VSWR max [dB]	Attenuation typ. [dB]
LP0603A0902ANTR	890-915	0.35 typ (0.5 max)	1.4	25 @ $2 \times F_0$ 14 @ $3 \times F_0$
LP0603A0947ANTR	935-960	0.35 typ (0.5 max)	1.4	25 @ $2 \times F_0$ 17 @ $3 \times F_0$
LP0603A1747ANTR	1710-1785	0.3 typ (0.5 max)	1.4	25 @ $2 \times F_0$ 17 @ $3 \times F_0$
LP0603A1842ANTR	1805-1880	0.3 typ (0.5 max)	1.4	27 @ $2 \times F_0$ 15 @ $3 \times F_0$
LP0603A1880ANTR	1840-1920	0.3 typ (0.5 max)	1.4	25 @ $2 \times F_0$ 17 @ $3 \times F_0$
LP0603A1950ANTR	1920-1980	0.3 typ (0.5 max)	1.4	27 @ $2 \times F_0$ 15 @ $3 \times F_0$
LP0603A2140ANTR	2110-2170	0.3 typ (0.5 max)	1.4	27 @ $2 \times F_0$ 17 @ $3 \times F_0$
LP0603A2442ANTR	2412-2472	0.3 typ (0.5 max)	1.4	25 @ $2 \times F_0$ 17 @ $3 \times F_0$

Note: additional frequencies available upon request

Thin-Film Low Pass Filter

LP0603 Lead-Free LGA Type Test Jig

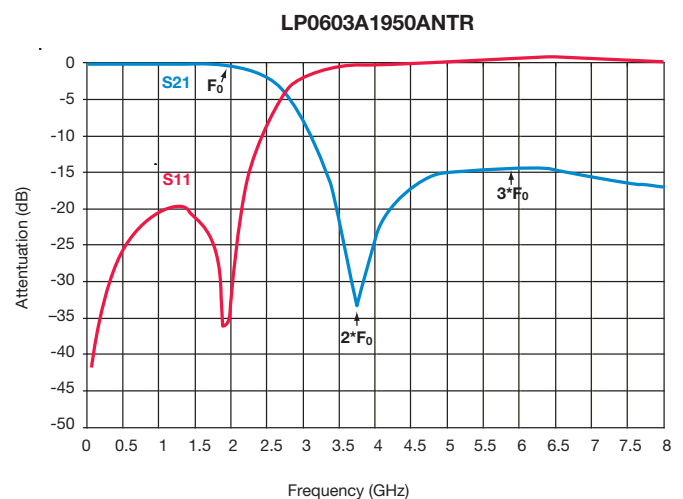
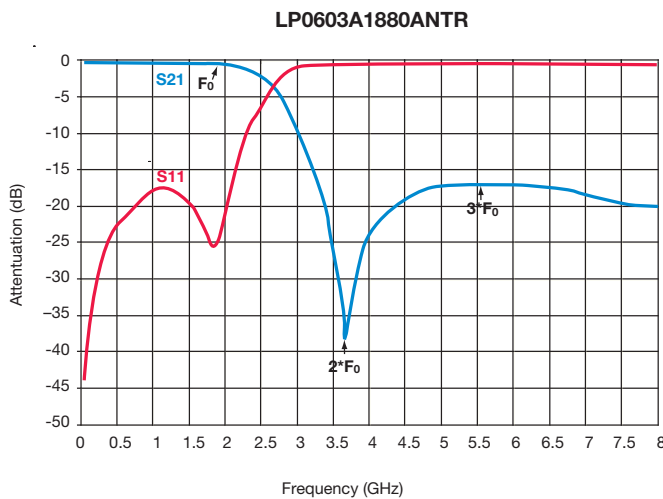
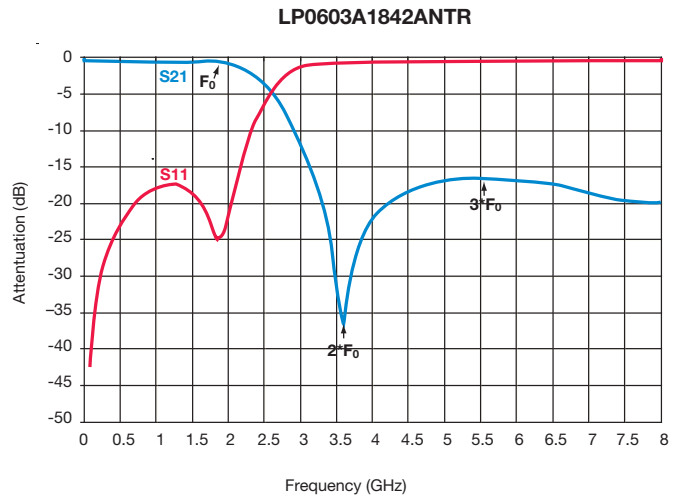
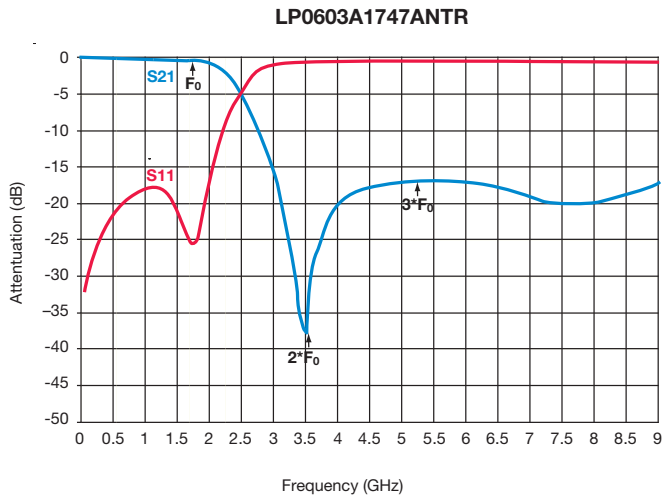
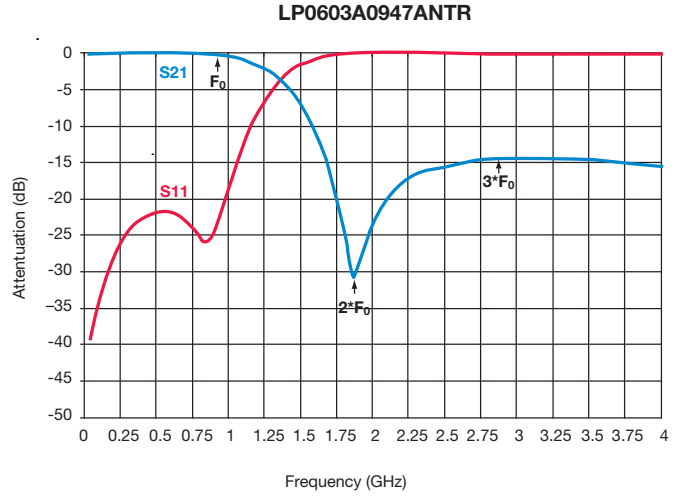
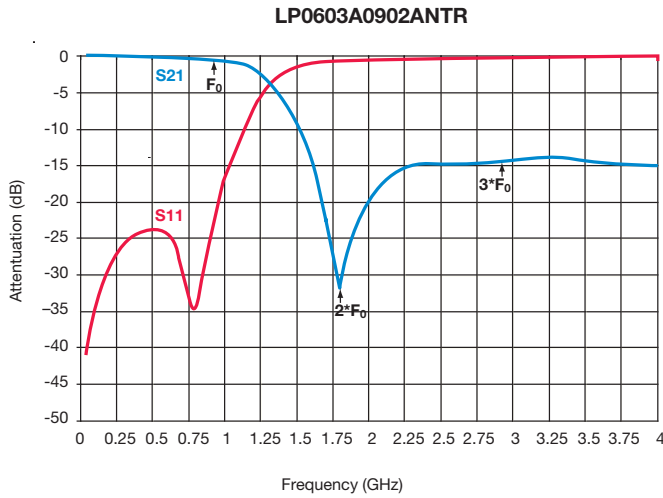

4

Thin-Film Low Pass Filter



LP0603 Lead-Free LGA Type Test Jig

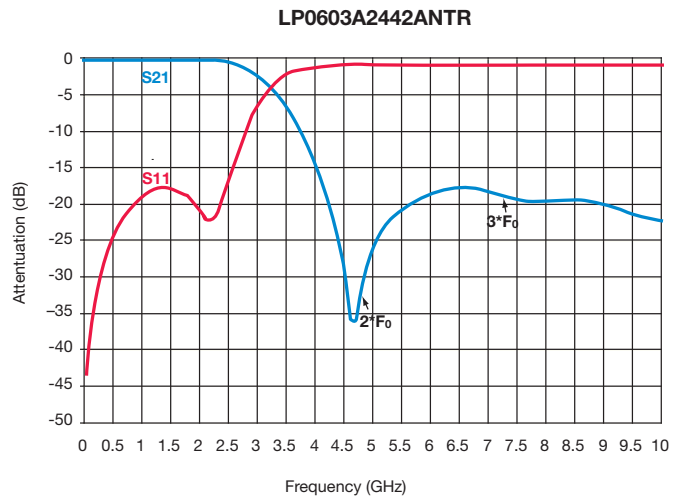
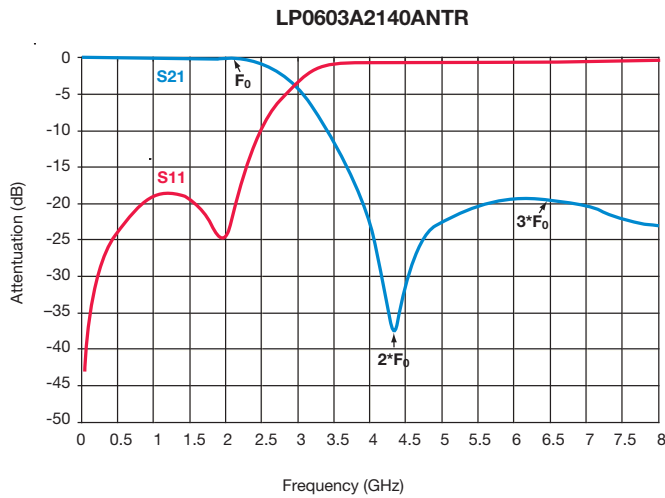

TEST JIG FOR LP0603 LEAD-FREE LGA LOW PASS FILTER

GENERAL DESCRIPTION

These jigs are designed for testing the LP0603 LGA Low Pass Filters using a Vector Network Analyzer.

They consist of a dielectric substrate, having 50Ω microstrips as conducting lines and a bottom ground plane located at a distance of 0.127mm from the microstrips.

The substrate used is Neltec's NH9338ST0127C1BC (or similar).

The connectors are SMA type (female), 'Johnson Components Inc.' Product P/N: 142-0701-841 (or similar).

Both a measurement jig and a calibration jig are provided.

The calibration jig is designed for a full 2-port calibration, and consists of an open line, short line and through line. LOAD calibration can be done by a 50Ω SMA termination.

MEASUREMENT PROCEDURE

Follow the VNA's instruction manual and use the [calibration jig](#) to perform a full 2-Port calibration in the required bandwidths.

Solder the filter to the [measurement jig](#) as follows:

- | | | | |
|-----------------|---------------------|--------------|-------------|
| Input (Filter) | ➔ Connector 1 (Jig) | GND (Filter) | ➔ GND (Jig) |
| Output (Filter) | ➔ Connector 2 (Jig) | GND (Filter) | ➔ GND (Jig) |

Set the VNA to the relevant frequency band. Connect the VNA using a 10dB attenuator on the jig terminal connected to port 2 (using an RF cable).

Measurement

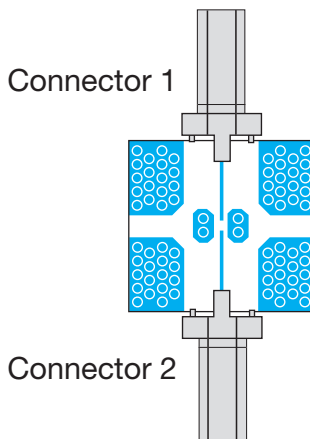

Calibration Jig

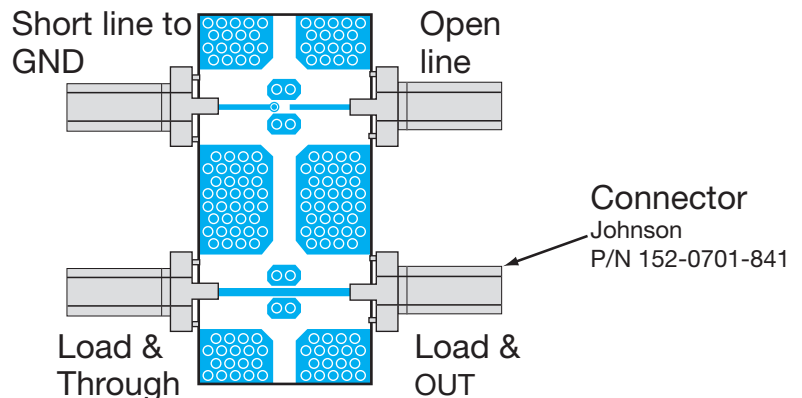

Thin-Film Low Pass Filter

LP0805 Type Harmonic

GENERAL DESCRIPTION

The ITF (Integrated Thin-Film) SMD Filter is based on thin-film multilayer technology. The technology provides a miniature part with excellent high frequency performance and rugged construction for reliable automatic assembly.

The ITF Filter is offered in a variety of frequency bands compatible with various types of high frequency wireless systems.

FEATURES

- Small Size: 0805
- Frequency Range: 800MHz - 3.5GHz
- Characteristic Impedance: 50Ω
- Operating / Storage Temp.: -40°C to +85°C
- Power Rating: 3W Continuous
- Low Profile
- Rugged Construction
- Taped and Reeled

APPLICATIONS

- Mobile Communications
- Satellite TV Receivers
- GPS
- Vehicle Location Systems
- Wireless LAN's

DIMENSIONS: millimeters (inches)

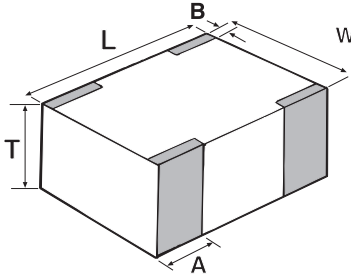

L	2.03±0.1 (0.080±0.004)
W	1.55±0.1 (0.061±0.004)
T	1.02±0.1 (0.040±0.004)
A	0.56±0.25 (0.022±0.010)
B	0.35±0.15 (0.014±0.006)

FINAL QUALITY INSPECTION

Finished parts are 100% tested for electrical parameters and visual/mechanical characteristics. Each production lot is evaluated on a sample basis for:

- Static Humidity: 85°C, 85% RH, 160 hours
- Endurance: 125°C, I_R 4 hours

TERMINATION

Nickel/Solder coating (Sn, Pb) compatible with automatic soldering technologies: reflow, wave soldering, vapor phase and manual.

HOW TO ORDER

LP
T
Style
Low Pass

0805A
T
Size
0805

0902
T
Frequency
MHz

AW
T
Termination
Nickel/Solder (Sn/Pb)

TR
T
Packaging Code
TR = Tape and Reel

TERMINALS AND LAYOUT (Top View)

Orientation in Tape

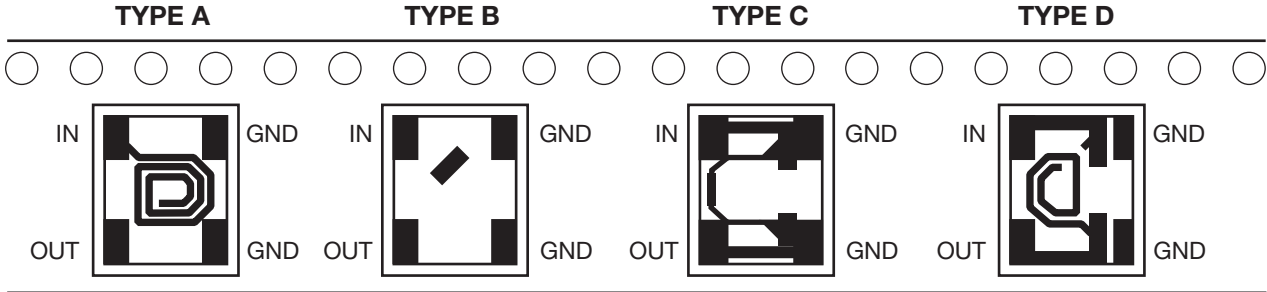

Thin-Film Low Pass Filter



LP0805 Type Harmonic

ELECTRICAL CHARACTERISTICS

Application	Part Number	Frequency Band (MHz)	I. Loss max	VSWR max	Attenuation (dB) Typical	Layout Type
E-GSM	LP0805A0897AW	880 - 915	0.4dB (0.3dB typ)	1.7	30 @ 2X F_o 20 @ 3x F_o	A
	LP0805A0942AW	925 - 960				A
GSM	LP0805A0902AW	890 - 915				A
	LP0805A0947AW	935 - 960				A
	LP0805A1119AW	1007 - 1231				A
AMPS	LP0805A0836AW	824 - 849				A
	LP0805A0881AW	869 - 894				A
PCN	LP0805A1747AW	1710 - 1785				D
	LP0805A1842AW	1805 - 1880				D
PCS	LP0805A1880AW	1850 - 1910				D
	LP0805A1960AW	1930 - 1990				D
PHP	LP0805A1907AW	1895 - 1920				D
DECT	LP0805A1890AW	1880 - 1900				D
3G	LP0805A2150AW	1935 - 2365				B
Wireless LAN	LP0805A2442AW	2400 - 2484				B
WLL	LP0805A3500AW	3400 ~ 3600				C

Typical Electrical Performance

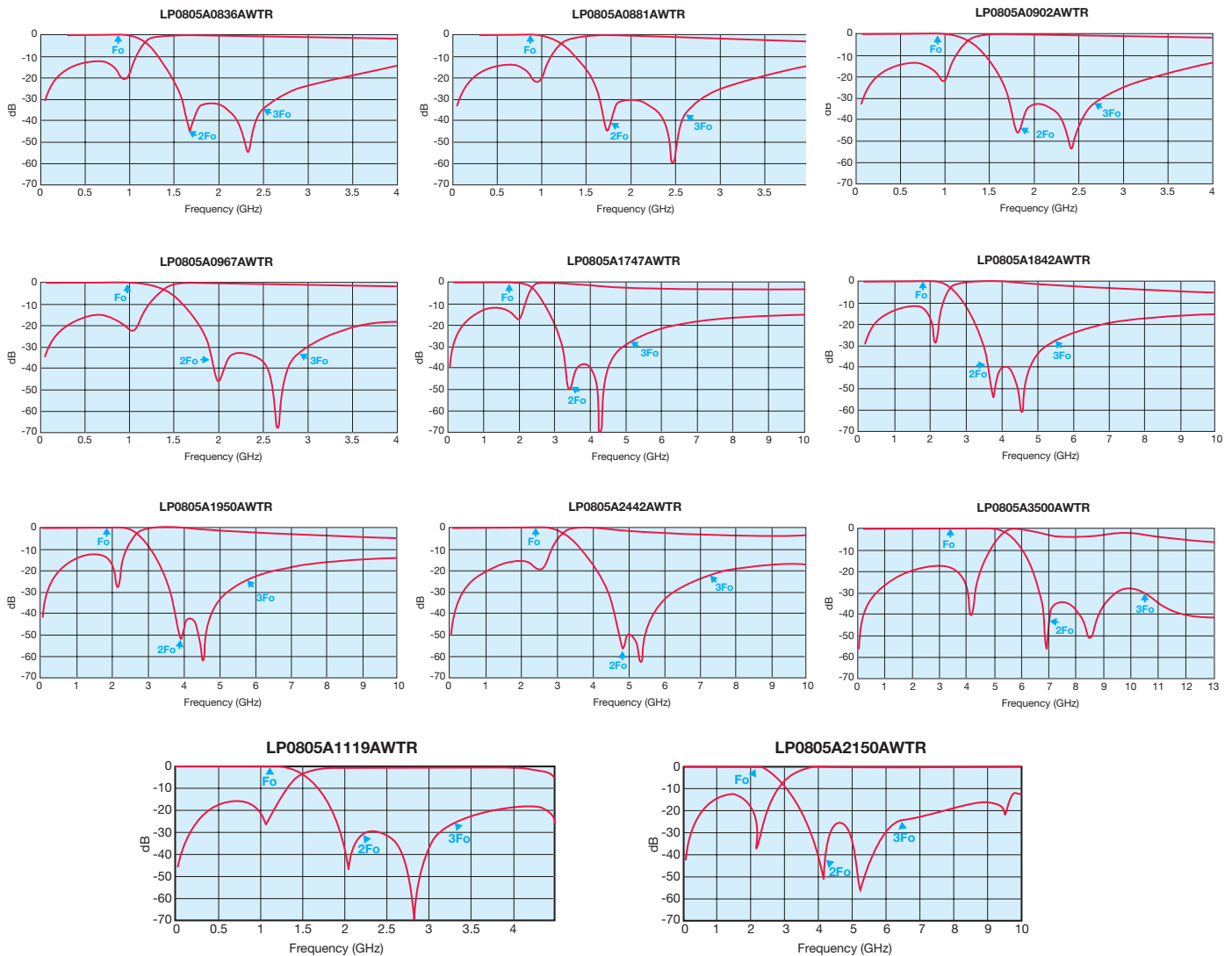

4



Thin-Film Low Pass Filter



LP0805 Test Jig

ITF TEST JIG FOR LOW PASS FILTER 0805

GENERAL DESCRIPTION

This jig is designed for the testing of the 0805 Low Pass Filter using a vector network analyzer.

It consists of a FR4 multi-layer substrate, having 50Ω microstrips as conducting lines and a ground plane in the middle layer, located at a distance of 0.2mm from the microstrips.

The connectors are SMA type (female), 'Johnson Components Inc.' Product P/N: 142-0701-881.

CALIBRATION AND MEASUREMENT PROCEDURE

The jig is designed for a full 2-port calibration. LOAD calibration is carried out using a 50Ω SMA termination.

To measure a component, it can be either soldered or pressed down by a non-metallic stick until all four ports touch the appropriate pads.

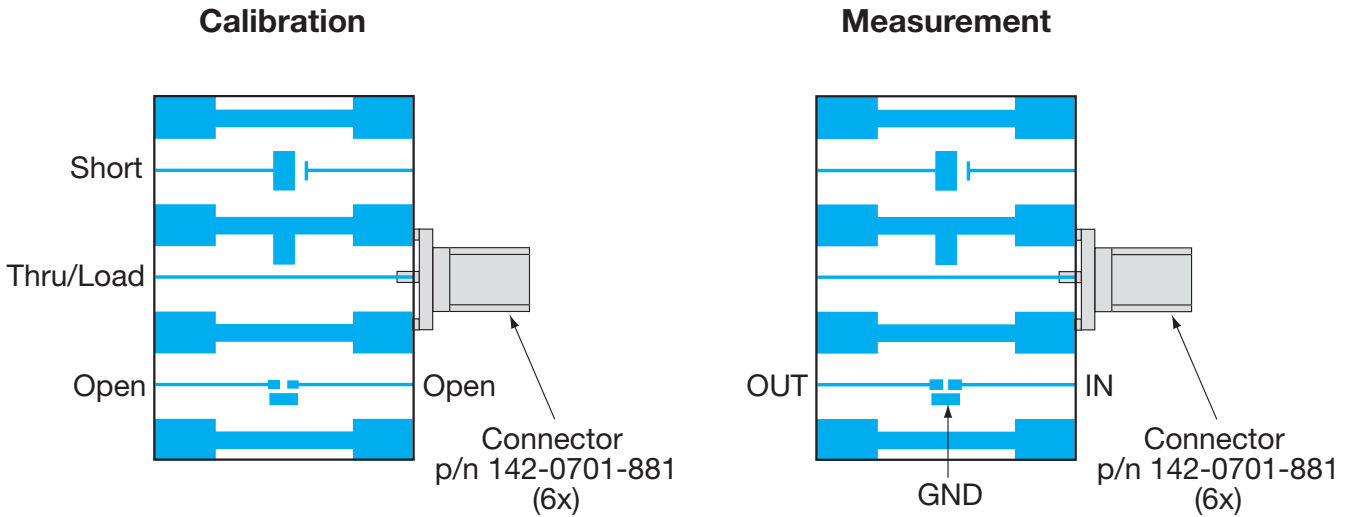

4



Thin-Film Products Designer Kits

Accu-P[®]/Accu-L[®] Kits



RF/Microwave Thin-Film Products



Designer Kits *(Special Kits Available Upon Request)*

Accu-P®
Designer Kit Type 1700
Order Number: Accu-P® 0201KIT02

Volts	Capacitors Value pF	Tolerance
25	0.1	A
	0.2	A
	0.3	A
	0.4	B
	0.5	B
	0.6	B
	0.7	B
	0.8	B
	0.9	B
	1.0	B
	1.1	B
	1.2	B
	1.3	B
	1.5	B
	1.8	B
16	2.0	B
	2.2	B
	2.4	B
	2.7	B
10	3.0	B
	3.3	B
	3.6	B
	3.9	B
	4.7	B
10	5.6	B
	6.8	B
	7.5	B
	8.2	B
	10.0	G
12.0	G	

600 Capacitors, 20 each of 30 values
Tolerance A = ± 0.05pF
 B = ± 0.1pF
 G = ± 2%

Accu-P®
Designer Kit Type 1800
Order Number: Accu-P® 0201KIT03

Volts	Capacitors Value pF	Tolerance
25	1.0	A
	1.1	A
	1.2	A
	1.3	A
	1.4	A
	1.5	A
	1.6	A
	1.7	A
	1.8	A
	1.9	A
	2.0	A
	2.1	B
	2.2	B
	2.3	B
	2.4	B
16	2.5	B
	2.6	B
	2.7	B
	2.8	B
	2.9	B
10	3.0	B
	3.1	B
	3.3	B
	3.4	B
	3.6	B
10	3.9	B
	4.1	B
	4.3	B
	4.5	B
4.7	B	

600 Capacitors, 20 each of 30 values
Tolerance A = ± 0.05pF
 B = ± 0.1pF

Accu-P®
Designer Kit Type 1300
Order Number: Accu-P® 0402KIT01

Volts	Capacitors Value pF	Tolerance
25	0.1	A
	0.2	A
	0.3	A
	0.4	B
	0.5	B
	0.6	B
	0.7	B
	0.8	B
	0.9	B
	1.0	B
	1.1	B
	1.2	B
	1.5	B
	1.8	B
	16	2.0
2.2		B
2.4		B
2.7		B
3.0		B
10	3.3	B
	3.9	B
	4.7	B
	5.6	B
	6.8	B
16	8.2	B
	10.0	G
10	12.0	G
	15.0	G
	18.0	G
	22.0	G

600 Capacitors, 20 each of 30 values
Tolerance A = ± 0.05pF
 B = ± 0.1pF
 G = ± 2%

Accu-P®
Designer Kit Type 1400
Order Number: Accu-P® 0402KIT02

Volts	Capacitors Value pF	Tolerance
25	1.0	A
	1.1	A
	1.2	A
	1.3	A
	1.4	A
	1.5	A
	1.6	A
	1.7	A
	1.8	A
	1.9	A
	2.0	A
	2.1	B
	2.2	B
	2.3	B
	2.4	B
	2.5	B
	2.6	B
	2.7	B
	2.8	B
	2.9	B
25	3.0	B
	3.1	B
	3.3	B
	3.4	B
	3.6	B
	3.9	B
	4.1	B
	4.3	B
4.5	B	
4.7	B	

600 Capacitors, 20 each of 30 values
Tolerance A = ± 0.05pF
 B = ± 0.1pF

Accu-P®
Designer Kit Type 900
Order Number: Accu-P® 0603KIT01

Volts	Capacitors Value pF	Tolerance
50	0.1	A
	0.2	A
	0.3	A
	0.4	B
	0.5	B
	0.6	B
	0.7	B
	0.8	B
	0.9	B
	1.0	B
	1.1	B
	1.2	B
	1.5	B
	1.8	B
	25	2.0
2.2		B
2.4		B
2.7		B
3.0		B
3.3		B
3.9		B
4.7		B
5.6		B
6.8		B
25	8.2	B
	10.0	G
	12.0	G
	15.0	G
	18.0	G
22.0	G	

600 Capacitors, 20 each of 30 values
Tolerance A = ± 0.05pF
 B = ± 0.1pF
 G = ± 2%

Accu-P®
Designer Kit Type 800
Order Number: Accu-P® 0805KIT02

Volts	Capacitors Value pF	Tolerance
100	0.1	A
	0.2	A
	0.3	A
	0.4	A
	0.5	B
	0.7	B
	0.8	B
	0.9	B
	1.0	B
	1.2	B
	1.5	B
	1.8	B
	2.0	B
	2.2	B
	50	2.7
3.3		B
3.9		B
4.7		B
5.6		B
6.8		B
8.2		B
10.0		B
12.0		G
15.0		G
25	18.0	G
	22.0	G
	27.0	J
	33.0	J
	39.0	J
47.0	J	

300 Capacitors, 10 each of 30 values
Tolerance A = ± 0.05pF G = ± 2%
 B = ± 0.1pF J = ± 5%



RF/Microwave Thin-Film Products



Designer Kits *(Special Kits Available Upon Request)*

Accu-P®
Designer Kit Type 700
Order Number: Accu-P® 1210KIT02

Volts	Capacitors Value pF	Tolerance
100	1.0	B
	1.5	B
	1.8	B
	2.2	B
	2.7	B
	3.3	B
	4.7	B
	5.6	B
	6.8	B
	10.0	G
	12.0	G
	18.0	G
	22.0	G
	27.0	G
	33.0	G

150 Capacitors, 10 each of 15 values
Tolerance B = ± 0.1pF
G = ± 2%

Accu-P®
Designer Kit Type 2100
Order Number: Accu-P® 0402KIT03

Volts	Capacitors Value pF	Tolerance
25	0.05	P
	0.10	P
	0.15	P
	0.20	P
	0.25	P
	0.30	P
	0.35	P
	0.40	P
	0.45	P
	0.50	P
	0.55	P
	0.60	P
	0.65	P
	0.70	P
	0.75	P

300 Capacitors, 20 each of 15 values
Tolerance P = ± 0.02pF

Accu-P®
Designer Kit Type 2200
Order Number: Accu-P® 0603KIT02

Volts	Capacitors Value pF	Tolerance
50	0.05	P
	0.10	P
	0.15	P
	0.20	P
	0.25	P
	0.30	P
	0.35	P
	0.40	P
	0.45	P
	0.50	P
	0.55	P
	0.60	P
	0.65	P
	0.70	P
	0.75	P

300 Capacitors, 20 each of 15 values
Tolerance P = ± 0.02pF

Accu-P®
Designer Kit Type 2000
Order Number: Accu-P® 0201KIT04

Volts	Capacitors Value pF	Tolerance
25	0.05	P
	0.10	P
	0.15	P
	0.20	P
	0.25	P
	0.30	P
	0.35	P
	0.40	P
	0.45	P
	0.50	P
	0.55	P
	0.60	P
	0.65	P
	0.70	P
	0.75	P

300 Capacitors, 20 each of 15 values
Tolerance P = ± 0.02pF

Accu-L®
Designer Kit Type 1600
Order Number: Accu-L® 0603KIT02

Inductance Value (nH)	Tolerance
1.2	C
1.5	C
1.8	C
2.2	C
2.7	C
3.3	C
3.9	C
4.7	C
5.6	C
6.8	C
8.2	C
10	G
12	G
15	G

280 Inductors, 20 each of 14 values
Tolerance C = ±0.2nH
G = ±2%

Accu-L®
Designer Kit Type 1100
Order Number: Accu-L® 0805KIT02

Inductance Value (nH)	Tolerance
1.8	C
2.2	C
2.7	C
3.3	C
3.9	C
4.7	C
5.6	C
6.8	D
8.2	D
10.0	J
12.0	J
15.0	J
18.0	J
22.0	J

280 Inductors, 20 each of 14 values
Tolerance C = ±0.2nH
D = ±0.5nH
J = ±5%





RF/Microwave MLC's

AQ Series
CDR Series
Porcelain and Ceramic
RF/Microwave
Multilayer Capacitors
High Voltage RF Power Capacitors

6

Microwave MLC's



AQ Series

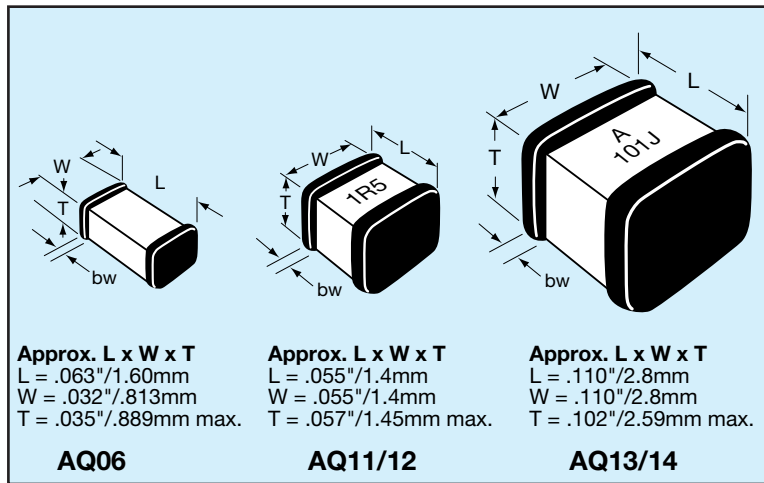

These porcelain and ceramic dielectric multilayer capacitor (MLC) chips are best suited for RF/Microwave applications typically ranging from 10 MHz to 4.2 GHz. Characteristic is a fine grained, high density, high purity dielectric material impervious to moisture with heavy internal palladium electrodes.

These characteristics lend well to applications requiring:

- 1) high current carrying capabilities;
- 2) high quality factors;
- 3) very low equivalent series resistance;
- 4) very high series resonance;
- 5) excellent stability under stresses of changing voltage, frequency, time and temperature.

MECHANICAL DIMENSIONS: inches (millimeters)

Case	Length (L)	Width (W)	Thickness (T)	Band Width (bw)
AQ06	.063±.006 (1.60±.152)	.032±.006 (.813±.152)	.035 Max. (.889)	.014±.006 (.357 +.152)
AQ11	.055±.015 (1.40±.381)	.055±.015 (1.40±.381)	.020/.057 (.508/1.45)	.010 + .010 -.005 (.254 +.254 -.127)
AQ12	.055 + .015 - .010 (1.40+ .381 - .254)	.055±.015 (1.40±.381)	.020/.057 (.508/1.45)	.010 + .010 -.005 (.254 +.254 -.127)
AQ13	.110±.020 (2.79±.508)	.110±.020 (2.79±.508)	.030/.102 (.762/2.59)	.015±.010 (.381±.254)
AQ14	.110 + .020 - .010 (2.79 +.889 -.254)	.110±.010 (2.79±.508)	.030/.102 (.762/2.59)	.015±.010 (.381±.254)

*For Tape and Reel packaging details see page 88

HOW TO ORDER

6

<p>AQ</p> <p>AVX Style AQ06, AQ11, AQ12, AQ13, AQ14</p>	<p>11</p> <p>Case Size (See Chart)</p>	<p>E</p> <p>Voltage Code 5 = 50V 1 = 100V E = 150V 2 = 200V V = 250V 9 = 300V 7 = 500V</p>	<p>M</p> <p>Temperature Coefficient Code M = +90±20ppm/°C (AQ06/11/12/13/14) A = 0±30ppm/°C (AQ11/12/13/14) C = 15% ("J" Termination only) (AQ12/14)</p>	<p>100</p> <p>Capacitance EIA Capacitance Code in pF. First two digits = significant figures or "R" for decimal place. Third digit = number of zeros or after "R" significant figures.</p>	<p>J</p> <p>Capacitance Tolerance Code A = ±.05 pF B = ±.1 pF C = ±.25 pF D = ±.5 pF F = ±1% G = ±2% J = ±5% K = ±10% M = ±20% N = ±30%</p>	<p>A</p> <p>Failure Rate Code A = Not Applicable</p>	<p>1</p> <p>Termination Style Code 1 = Pd/Ag (AQ11/13 only) 7 = Ag/Ni/Au (AQ11/13 only) J = Nickel Barrier Sn/Pb (60/40) - (AQ06/12/14 only)</p>	<p>ME</p> <p>Packaging* Code 3A = 13" Reel (AQ06 only) 6A = Waffle Pack (AQ06 only) ME = 7" Reel RE = 13" Reel WE = Waffle Pack 1A = 7" Reel (AQ06 only)</p>
--	---	---	---	---	--	---	---	---

PACKAGING

Standard Packaging = Waffle Pack (for T&R packaging see page 88)
AQ11/12 maximum quantity per waffle pack is 100.
AQ13/14 maximum quantity is 80.



ELECTRICAL SPECIFICATIONS

AQ06, AQ11, AQ12, AQ13, AQ14		
	M & A	C
Temperature Coefficient	(M) +90 ±20PPM/°C and (A) 0 ±30PPM/°C	±15%
Capacitance Range	0.1 pF to 5100 pF	0.001µF to 0.1µF
Capacitance Tolerance	±0.1 pF to ±20%	±10%, ±20%, ±30%
Operating Temperature	-55°C + 125°C	-55°C to +125°C
Quality Factor or Dissipation Factor	Per MIL-PRF-55681/4	2.5% @ 1kHz
Insulation Resistance	Per MIL-PRF-55681 10 ⁶ megohm to 470 pF @ +25°C 10 ⁵ megohm to 470 pF @ +125°C 10 ⁵ megohm above 470 pF @ +25°C 10 ⁴ megohm above 470 pF @ +125°C	10 ⁴ megohm min @ 25°C & R VDC 10 ³ megohm min @ 25°C & R VDC
Aging	None	<3% per decade hour
Piezoelectric Effects	None	None
Dielectric Withstanding Voltage	2.5 x rated voltage (for 500V rated 1.5 x rated voltage)	2.5 x rated voltage (for 500V rated 1.5 x rated voltage)

ENVIRONMENTAL CHARACTERISTICS

Will meet or exceed performance characteristics as outlined in MIL-PRF-55681/4.

REQUIREMENT	MIL-STD-202 METHOD
Life	108, Condition F
Shock	213, Condition J
Vibration	204, Condition B
Immersion	104, Condition B
Salt Spray	101, Condition B
Solderability	208
Thermal Shock	107, Condition B
Terminal Strength	211
Temperature Cycling	102, Condition C
Moisture Resistance	106
Barometric Pressure	105, Condition B
Resistance to Soldering Heat	210, Condition C

QUALITY FACTOR vs. FREQUENCY (Typical)

Capacitance	@ 30 MHz	@ 150 MHz	@ 500 MHz	@ 1000 MHz
1 pF	30000	4000	800	350
10 pF	9000	2000	400	150
30 pF	5000	800	200	60
100 pF	2800	400	70	25
200 pF	1500	250	40	12

CAPACITANCE AND SIZE vs. SERIES SELF RESONANT FREQUENCY (Typical)

DIMENSIONS: inches (millimeters)

Case	Size (Nominal)	1 pF	10 pF	50 pF	100 pF
AQ06	.063 x .032 x .035 (1.60 x .813 x .889)	9.6 GHz	3.2 GHz	1.5 GHz	1.0 GHz
AQ11/12	.055 x .055 x .057 (1.40 x 1.40 x 1.45)	9.6 GHz	3.2 GHz	1.5 GHz	1.0 GHz
AQ13/14	.110 x .110 x .102 (2.79 x 2.79 x 2.59)	6.4 GHz	2.2 GHz	1.0 GHz	0.7 GHz

Microwave MLC's



AQ Series Available Capacitance/Size/WVDC/T.C.

TABLE I: TC: M (+90±20PPM/°C)
CASE SIZE 06, 11, 12, 13 & 14

DIMENSIONS: inches (millimeters)

Case	Length	Width	Thickness	Band Width	Avail. Term.
06	.063±.006 (1.60±.152)	.032±.006 (.813±.152)	.035 Max. (.889)	.014±.006 (.357 ±.152)	J
11	.055±.015 (1.40±.381)	.055±.015 (1.40±.381)	.020/.057 (.508/1.45)	.010 +.010 -.005 (.254 +.254 -.127)	1 & 7
12	.055±.025 (1.40±.635)	.055±.015 (1.40±.381)	.020/.057 (.508/1.45)	.010 +.010 -.005 (.254 +.254 -.127)	J
13	.110±.020 (2.79±.508)	.110±.020 (2.79±.508)	.030/.102 (.762/2.59)	.015±.010 (.381±.254)	1 & 7
14	.110 +0.035 -0.020 (2.79 +.889 -.508)	.110±.020 (2.79±.508)	.030/.102 (.762/2.59)	.015±.010 (.381±.254)	J

Case: AQ06			Case: AQ11, AQ12			Case: AQ13, AQ14					
Cap. pF	Cap. Tol.	WVDC	Cap. pF	Cap. Tol.	WVDC	Cap. pF	Cap. Tol.	WVDC	Cap. pF	Cap. Tol.	WVDC
0.1	B	250	0.1	B	150	0.1	B	500	100	F, G, J, K, M	500
0.2	B	250	0.2	B	150	0.2	B	500	110	F, G, J, K, M	300
0.3	B,C	250	0.3	B,C	150	0.3	B,C	500	120	F, G, J, K, M	300
0.4	B,C	250	0.4	B,C	150	0.4	B,C	500	130	F, G, J, K, M	300
0.5	B, C, D	250	0.5	B, C, D	150	0.5	B, C, D	500	150	F, G, J, K, M	300
0.6	B, C, D	250	0.6	B, C, D	150	0.6	B, C, D	500	160	F, G, J, K, M	300
0.7	B, C, D	250	0.7	B, C, D	150	0.7	B, C, D	500	180	F, G, J, K, M	300
0.8	B, C, D	250	0.8	B, C, D	150	0.8	B, C, D	500	200	F, G, J, K, M	300
0.9	B, C, D	250	0.9	B, C, D	150	0.9	B, C, D	500	220	F, G, J, K, M	200
1.0	B, C, D	250	1.0	B, C, D	150	1.0	B, C, D	500	240	F, G, J, K, M	200
1.1	B, C, D	250	1.1	B, C, D	150	1.1	B, C, D	500	270	F, G, J, K, M	200
1.2	B, C, D	250	1.2	B, C, D	150	1.2	B, C, D	500	300	F, G, J, K, M	200
1.3	B, C, D	250	1.3	B, C, D	150	1.3	B, C, D	500	330	F, G, J, K, M	200
1.4	B, C, D	250	1.4	B, C, D	150	1.4	B, C, D	500	360	F, G, J, K, M	200
1.5	B, C, D	250	1.5	B, C, D	150	1.5	B, C, D	500	390	F, G, J, K, M	200
1.6	B, C, D	250	1.6	B, C, D	150	1.6	B, C, D	500	430	F, G, J, K, M	200
1.7	B, C, D	250	1.7	B, C, D	150	1.7	B, C, D	500	470	F, G, J, K, M	200
1.8	B, C, D	250	1.8	B, C, D	150	1.8	B, C, D	500	510	F, G, J, K, M	150
1.9	B, C, D	250	1.9	B, C, D	150	1.9	B, C, D	500	560	F, G, J, K, M	150
2.0	B, C, D	250	2.0	B, C, D	150	2.0	B, C, D	500	620	F, G, J, K, M	150
2.2	B, C, D	250	2.2	B, C, D	150	2.2	B, C, D	500	680	F, G, J, K, M	150
2.4	B, C, D	250	2.4	B, C, D	150	2.4	B, C, D	500	750	F, G, J, K, M	150
2.7	B, C, D	250	2.7	B, C, D	150	2.7	B, C, D	500	820	F, G, J, K, M	150
3.0	B, C, D	250	3.0	B, C, D	150	3.0	B, C, D	500	910	F, G, J, K, M	150
3.3	B, C, D	250	3.3	B, C, D	150	3.3	B, C, D	500	1000	F, G, J, K, M	150
3.6	B, C, D	250	3.6	B, C, D	150	3.6	B, C, D	500			
3.9	B, C, D	250	3.9	B, C, D	150	3.9	B, C, D	500			
4.3	B, C, D	250	4.3	B, C, D	150	4.3	B, C, D	500			
4.7	B, C, D	250	4.7	B, C, D	150	4.7	B, C, D	500			
5.1	B, C, D	250	5.1	B, C, D	150	5.1	B, C, D	500			
5.6	B, C, D	250	5.6	B, C, D	150	5.6	B, C, D	500			
6.2	B, C, D	250	6.2	B, C, D	150	6.2	B, C, D	500			
6.8	B, C, J, K, M	250	6.8	B, C, J, K, M	150	6.8	B, C, J, K, M	500			
7.5	B, C, J, K, M	250	7.5	B, C, J, K, M	150	7.5	B, C, J, K, M	500			
8.2	B, C, J, K, M	250	8.2	B, C, J, K, M	150	8.2	B, C, J, K, M	500			
9.1	B, C, J, K, M	250	9.1	B, C, J, K, M	150	9.1	B, C, J, K, M	500			
10	F, G, J, K, M	250	10	F, G, J, K, M	150	10	F, G, J, K, M	500			
11	F, G, J, K, M	250	11	F, G, J, K, M	150	11	F, G, J, K, M	500			
12	F, G, J, K, M	250	12	F, G, J, K, M	150	12	F, G, J, K, M	500			
13	F, G, J, K, M	250	13	F, G, J, K, M	150	13	F, G, J, K, M	500			
15	F, G, J, K, M	250	15	F, G, J, K, M	150	15	F, G, J, K, M	500			
16	F, G, J, K, M	250	16	F, G, J, K, M	150	16	F, G, J, K, M	500			
18	F, G, J, K, M	250	18	F, G, J, K, M	150	18	F, G, J, K, M	500			
20	F, G, J, K, M	250	20	F, G, J, K, M	150	20	F, G, J, K, M	500			
22	F, G, J, K, M	250	22	F, G, J, K, M	150	22	F, G, J, K, M	500			
24	F, G, J, K, M	250	24	F, G, J, K, M	150	24	F, G, J, K, M	500			
27	F, G, J, K, M	250	27	F, G, J, K, M	150	27	F, G, J, K, M	500			
30	F, G, J, K, M	250	30	F, G, J, K, M	150	30	F, G, J, K, M	500			
33	F, G, J, K, M	250	33	F, G, J, K, M	150	33	F, G, J, K, M	500			
36	F, G, J, K, M	50	36	F, G, J, K, M	150	36	F, G, J, K, M	500			
39	F, G, J, K, M	50	39	F, G, J, K, M	150	39	F, G, J, K, M	500			
43	F, G, J, K, M	50	43	F, G, J, K, M	150	43	F, G, J, K, M	500			
47	F, G, J, K, M	50	47	F, G, J, K, M	150	47	F, G, J, K, M	500			
51	F, G, J, K, M	50	51	F, G, J, K, M	150	51	F, G, J, K, M	500			
56	F, G, J, K, M	50	56	F, G, J, K, M	150	56	F, G, J, K, M	500			
62	F, G, J, K, M	50	62	F, G, J, K, M	150	62	F, G, J, K, M	500			
68	F, G, J, K, M	50	68	F, G, J, K, M	150	68	F, G, J, K, M	500			
75	F, G, J, K, M	50	75	F, G, J, K, M	150	75	F, G, J, K, M	500			
82	F, G, J, K, M	50	82	F, G, J, K, M	150	82	F, G, J, K, M	500			
91	F, G, J, K, M	50	91	F, G, J, K, M	150	91	F, G, J, K, M	500			
100	F, G, J, K, M	50	100	F, G, J, K, M	150						
120	F, G, J, K, M	50									

6



Microwave MLC's



AQ Series Available Capacitance/Size/WVDC/T.C.

**TABLE II: TC: A (0±30PPM/°C)
CASE SIZE 06, 11, 12, 13 & 14**

DIMENSIONS: inches (millimeters)

Case	Length	Width	Thickness	Band Width	Avail. Term.
06	.063±.006 (1.60±.152)	.032±.006 (.813±.152)	.035 Max. (.889)	.014±.006 (.357 +.152)	J
11	.055±.015 (1.40±.381)	.055±.015 (1.40±.381)	.020/.057 (.508/1.45)	.010 +.010 -.005 (.254 +.254 -.127)	1 & 7
12	.055±.025 (1.40±.635)	.055±.015 (1.40±.381)	.020/.057 (.508/1.45)	.010 +.010 -.005 (.254 +.254 -.127)	J
13	.110±.020 (2.79±.508)	.110±.020 (2.79±.508)	.030/.102 (.762/2.59)	.015±.010 (.381±.254)	1 & 7
14	.110 +0.035 -0.020 (2.79 +.889 -.508)	.110±.020 (2.79±.508)	.030/.102 (.762/2.59)	.015±.010 (.381±.254)	J

Case: AQ06		
Cap. pF	Cap. Tol.	WVDC
0.1	B	250
0.2	B	250
0.3	B,C	250
0.4	B,C	250
0.5	B, C, D	250
0.6	B, C, D	250
0.7	B, C, D	250
0.8	B, C, D	250
0.9	B, C, D	250
1.0	B, C, D	250
1.1	B, C, D	250
1.2	B, C, D	250
1.3	B, C, D	250
1.4	B, C, D	250
1.5	B, C, D	250
1.6	B, C, D	250
1.7	B, C, D	250
1.8	B, C, D	250
1.9	B, C, D	250
2.0	B, C, D	250
2.2	B, C, D	250
2.4	B, C, D	250
2.7	B, C, D	250
3.0	B, C, D	250
3.3	B, C, D	250
3.6	B, C, D	250
3.9	B, C, D	250
4.3	B, C, D	250
4.7	B, C, D	250
5.1	B, C, D	250
5.6	B, C, D	250
6.2	B, C, D	250
6.8	B, C, J, K, M	250
7.5	B, C, J, K, M	250
8.2	B, C, J, K, M	250
9.1	B, C, J, K, M	250
10	F, G, J, K, M	250
11	F, G, J, K, M	250
12	F, G, J, K, M	250
13	F, G, J, K, M	250
15	F, G, J, K, M	250
16	F, G, J, K, M	250
18	F, G, J, K, M	250
20	F, G, J, K, M	250
22	F, G, J, K, M	250
24	F, G, J, K, M	250
27	F, G, J, K, M	250
30	F, G, J, K, M	250
33	F, G, J, K, M	250
36	F, G, J, K, M	50
39	F, G, J, K, M	50
43	F, G, J, K, M	50
47	F, G, J, K, M	50
51	F, G, J, K, M	50
56	F, G, J, K, M	50
62	F, G, J, K, M	50
68	F, G, J, K, M	50
75	F, G, J, K, M	50
82	F, G, J, K, M	50
91	F, G, J, K, M	50
100	F, G, J, K, M	50
120	F, G, J, K, M	50

Case: AQ11, AQ12					
Cap. pF	Cap. Tol.	WVDC	Cap. pF	Cap. Tol.	WVDC
0.1	B	150	24	F, G, J, K, M	150
0.2	B	150	27	F, G, J, K, M	150
0.3	B,C	150	30	F, G, J, K, M	150
0.4	B,C	150	33	F, G, J, K, M	150
0.5	B, C, D	150	36	F, G, J, K, M	150
0.6	B, C, D	150	39	F, G, J, K, M	150
0.7	B, C, D	150	43	F, G, J, K, M	150
0.8	B, C, D	150	47	F, G, J, K, M	150
0.9	B, C, D	150	51	F, G, J, K, M	150
1.0	B, C, D	150	56	F, G, J, K, M	150
1.1	B, C, D	150	62	F, G, J, K, M	150
1.2	B, C, D	150	68	F, G, J, K, M	150
1.3	B, C, D	150	75	F, G, J, K, M	150
1.4	B, C, D	150	82	F, G, J, K, M	150
1.5	B, C, D	150	91	F, G, J, K, M	150
1.6	B, C, D	150	100	F, G, J, K, M	150
1.7	B, C, D	150	110	F, G, J, K, M	50
1.8	B, C, D	150	120	F, G, J, K, M	50
1.9	B, C, D	150	130	F, G, J, K, M	50
2.0	B, C, D	150	150	F, G, J, K, M	50
2.2	B, C, D	150	160	F, G, J, K, M	50
2.4	B, C, D	150	180	F, G, J, K, M	50
2.7	B, C, D	150	200	F, G, J, K, M	50
3.0	B, C, D	150	220	F, G, J, K, M	50
3.3	B, C, D	150	240	F, G, J, K, M	50
3.6	B, C, D	150	270	F, G, J, K, M	50
3.9	B, C, D	150	300	F, G, J, K, M	50
4.3	B, C, D	150	330	F, G, J, K, M	50
4.7	B, C, D	150	360	F, G, J, K, M	50
5.1	B, C, D	150	390	F, G, J, K, M	50
5.6	B, C, D	150	430	F, G, J, K, M	50
6.2	B, C, D	150	470	F, G, J, K, M	50
6.8	B, C, J, K, M	150	510	F, G, J, K, M	50
7.5	B, C, J, K, M	150	560	F, G, J, K, M	50
8.2	B, C, J, K, M	150	620	F, G, J, K, M	50
9.1	B, C, J, K, M	150	680	F, G, J, K, M	50
10	F, G, J, K, M	150	750	F, G, J, K, M	50
11	F, G, J, K, M	150	820	F, G, J, K, M	50
12	F, G, J, K, M	150	910	F, G, J, K, M	50
13	F, G, J, K, M	150	1000	F, G, J, K, M	50
15	F, G, J, K, M	150			
16	F, G, J, K, M	150			
18	F, G, J, K, M	150			
20	F, G, J, K, M	150			
22	F, G, J, K, M	150			

Case: AQ13, AQ14					
Cap. pF	Cap. Tol.	WVDC	Cap. pF	Cap. Tol.	WVDC
0.1	B	500	51	F, G, J, K, M	500
0.2	B	500	56	F, G, J, K, M	500
0.3	B,C	500	62	F, G, J, K, M	500
0.4	B,C	500	68	F, G, J, K, M	500
0.5	B, C, D	500	75	F, G, J, K, M	500
0.6	B, C, D	500	82	F, G, J, K, M	500
0.7	B, C, D	500	91	F, G, J, K, M	500
0.8	B, C, D	500	100	F, G, J, K, M	500
0.9	B, C, D	500	110	F, G, J, K, M	300
1.0	B, C, D	500	120	F, G, J, K, M	300
1.1	B, C, D	500	130	F, G, J, K, M	300
1.2	B, C, D	500	150	F, G, J, K, M	300
1.3	B, C, D	500	160	F, G, J, K, M	300
1.4	B, C, D	500	180	F, G, J, K, M	300
1.5	B, C, D	500	200	F, G, J, K, M	300
1.6	B, C, D	500	220	F, G, J, K, M	200
1.7	B, C, D	500	240	F, G, J, K, M	200
1.8	B, C, D	500	270	F, G, J, K, M	200
1.9	B, C, D	500	300	F, G, J, K, M	200
2.0	B, C, D	500	330	F, G, J, K, M	200
2.2	B, C, D	500	360	F, G, J, K, M	200
2.4	B, C, D	500	390	F, G, J, K, M	200
2.7	B, C, D	500	430	F, G, J, K, M	200
3.0	B, C, D	500	470	F, G, J, K, M	200
3.3	B, C, D	500	510	F, G, J, K, M	150
3.6	B, C, D	500	560	F, G, J, K, M	150
3.9	B, C, D	500	620	F, G, J, K, M	150
4.3	B, C, D	500	680	F, G, J, K, M	150
4.7	B, C, D	500	750	F, G, J, K, M	150
5.1	B, C, D	500	820	F, G, J, K, M	150
5.6	B, C, D	500	910	F, G, J, K, M	150
6.2	B, C, D	500	1000	F, G, J, K, M	150
6.8	B, C, J, K, M	500	1100	F, G, J, K, M	50
7.5	B, C, J, K, M	500	1200	F, G, J, K, M	50
8.2	B, C, J, K, M	500	1300	F, G, J, K, M	50
9.1	B, C, J, K, M	500	1500	F, G, J, K, M	50
10	F, G, J, K, M	500	1600	F, G, J, K, M	50
11	F, G, J, K, M	500	1800	F, G, J, K, M	50
12	F, G, J, K, M	500	2000	F, G, J, K, M	50
13	F, G, J, K, M	500	2200	F, G, J, K, M	50
15	F, G, J, K, M	500	2400	F, G, J, K, M	50
16	F, G, J, K, M	500	2700	F, G, J, K, M	50
18	F, G, J, K, M	500	3000	F, G, J, K, M	50
20	F, G, J, K, M	500	3300	F, G, J, K, M	50
22	F, G, J, K, M	500	3600	F, G, J, K, M	50
24	F, G, J, K, M	500	3900	F, G, J, K, M	50
27	F, G, J, K, M	500	4300	F, G, J, K, M	50
30	F, G, J, K, M	500	4700	F, G, J, K, M	50
33	F, G, J, K, M	500	5000	F, G, J, K, M	50
36	F, G, J, K, M	500	5100	F, G, J, K, M	50
39	F, G, J, K, M	500			
43	F, G, J, K, M	500			
47	F, G, J, K, M	500			

TABLE III: TC: C (±15%) CASE SIZE 12 & 14

Case: AQ12									Case: AQ14									
Cap. pF	Cap. Tol.	WVDC	Cap. pF	Cap. Tol.	WVDC	Cap. pF	Cap. Tol.	WVDC	Cap. pF	Cap. Tol.	WVDC	Cap. pF	Cap. Tol.	WVDC	Cap. pF	Cap. Tol.	WVDC	
1000	K, M, N	50	2200	K, M, N	50	5100	K, M, N	50	5000	K, M, N	50	15000	K, M, N	50	47000	K, M, N	50	
1200	K, M, N	50	2700	K, M, N	50	5600	K, M, N	50	6800	K, M, N	50	18000	K, M, N	50	68000	K, M, N	50	
1500	K, M, N	50	3300	K, M, N	50	6800	K, M, N	50	8200	K, M, N	50		27000	K, M, N	50	82000	K, M, N	50
1800	K, M, N	50	3900	K, M, N	50	8200	K, M, N	50	10000	K, M, N	50		33000	K, M, N	50	100000	K, M, N	50
2000	K, M, N	50	4700	K, M, N	50	10000	K, M, N	50	12000	K, M, N	50		39000	K, M, N	50			



6

Microwave MLC's



CDR Series — MIL-PRF-55681 (RF/Microwave Chips)

MILITARY DESIGNATION PER MIL-PRF-55681

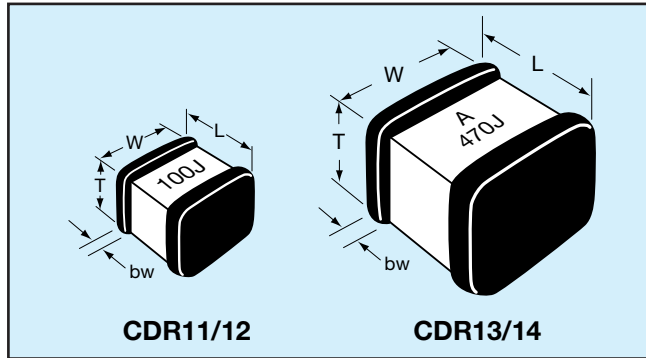

CROSS REFERENCE: AVX/MIL-PRF-55681

Per MIL-C-55681	AVX Style	Length (L)	Width (W)	Thickness (T)		Termination Band (bw)	
				Max	Min	Max	Min
CDR11	AQ11	.055±.015 (1.40±.381)	.055±.015 (1.40±.381)	.057 (1.45)	.020 (.508)	.020 (.508)	.005 (.127)
CDR12	AQ12	.055±.025 (1.40±.635)	.055±.015 (1.40±.381)	.057 (1.45)	.020 (.508)	.020 (.508)	.005 (.127)
CDR13	AQ13	.110±.020 (2.79±.508)	.110±.020 (2.79±.508)	.102 (2.59)	.030 (.762)	.025 (.635)	.005 (.127)
CDR14	AQ14	.110 +.035 -0.20 (2.79 +.889 -.508)	.110±.020 (2.79±.508)	.102 (2.59)	.030 (.762)	.025 (.635)	.005 (.127)

HOW TO ORDER

CDR12

MIL Style
CDR11, CDR12,
CDR13, CDR14

BG

**Voltage
Temperature
Limits**

BG = +90±20 ppm/°C
with and without
rated voltage from
-55°C to +125°C
BP = 0±30ppm/°C
with and without
rated voltage from
-55°C to +125°C

101

Capacitance

EIA Capacitance Code in pF.
First two digits = significant figures
or "R" for decimal place.
Third digit = number of zeros or
after "R" significant figures.

A

**Rated Voltage
Code**

A = 50V
B = 100V
C = 200V
D = 300V
E = 500V

K

**Capacitance
Tolerance Code**

B = ±.1 pF
C = ±.25 pF
D = ±.5 pF
F = ±1%
G = ±2%
J = ±5%
K = ±10%
M = ±20%

U

**Termination
Finish (Military
Designations)
Code**

M = Palladium/Silver
(CDR11 & 13 only)
N = Silver, Nickel, Gold
(CDR11 & 13 only)
S = Solder Coated, Final
(CDR12 & 14 only)
U = Base Metalization, Barrier Metal,
Solder Coated.
(Solder M.P. 200°C or less)
(CDR12 & 14 only)
W = Base Metalization, Barrier Metal,
Tinned (Tin or Tin/Lead Alloy)
(CDR12 & 14 only)
Y = 100% Tin
Z = Base Metalization, Barrier Metal
(Tin Lead Alloy With 4% Lead Min.)

S

**Failure Rate
Level**

M = 1.0%
P = .1%
R = .01%
S = .001%

6

PACKAGING

Standard Packaging = Waffle Pack (for T&R packaging see page 88)
AQ11/12 maximum quantity per waffle pack is 100.
AQ13/14 maximum quantity is 80.

Microwave MLC's



CDR Series — MIL-PRF-55681 (RF/Microwave Chips)

TABLE I: STYLES CDR11 AND CDR12 CAPACITOR CHARACTERISTICS

Type Designation 1/	Capacitance in pF	Capacitance tolerance	Rated temperature and V/Temperature	WVDC	Type Designation 1/	Capacitance in pF	Capacitance tolerance	Rated temperature and V/Temperature	WVDC
CDR1 -B-0R1AB--	0.1	B	BG, BP	50	CDR1 -B-300A--	30	F, G, J, K, M	BG, BP	50
CDR1 -B-0R2AB--	0.2	B	BG, BP	50	CDR1 -B-330A--	33	F, G, J, K, M	BG, BP	50
CDR1 -B-0R3A--	0.3	B, C	BG, BP	50	CDR1 -B-360A--	36	F, G, J, K, M	BG, BP	50
CDR1 -B-0R4A--	0.4	B, C	BG, BP	50	CDR1 -B-390A--	39	F, G, J, K, M	BG, BP	50
CDR1 -B-0R5A--	0.5	B, C, D	BG, BP	50	CDR1 -B-430A--	43	F, G, J, K, M	BG, BP	50
CDR1 -B-0R6A--	0.6	B, C, D	BG, BP	50	CDR1 -B-470A--	47	F, G, J, K, M	BG, BP	50
CDR1 -B-0R7A--	0.7	B, C, D	BG, BP	50	CDR1 -B-510A--	51	F, G, J, K, M	BG, BP	50
CDR1 -B-0R8A--	0.8	B, C, D	BG, BP	50	CDR1 -B-560A--	56	F, G, J, K, M	BG, BP	50
CDR1 -B-0R9A--	0.9	B, C, D	BG, BP	50	CDR1 -B-620A--	62	F, G, J, K, M	BG, BP	50
CDR1 -B-1R0A--	1.0	B, C, D	BG, BP	50	CDR1 -B-680A--	68	F, G, J, K, M	BG, BP	50
CDR1 -B-1R1A--	1.1	B, C, D	BG, BP	50	CDR1 -B-750A--	75	F, G, J, K, M	BG, BP	50
CDR1 -B-1R2A--	1.2	B, C, D	BG, BP	50	CDR1 -B-820A--	82	F, G, J, K, M	BG, BP	50
CDR1 -B-1R3A--	1.3	B, C, D	BG, BP	50	CDR1 -B-910A--	91	F, G, J, K, M	BG, BP	50
CDR1 -B-1R4A--	1.4	B, C, D	BG, BP	50	CDR1 -B-101A--	100	F, G, J, K, M	BG, BP	50
CDR1 -B-1R5A--	1.5	B, C, D	BG, BP	50	CDR1 -B-111A--	110	F, G, J, K, M	BP	50
CDR1 -B-1R6A--	1.6	B, C, D	BG, BP	50	CDR1 -B-121A--	120	F, G, J, K, M	BP	50
CDR1 -B-1R7A--	1.7	B, C, D	BG, BP	50	CDR1 -B-131A--	130	F, G, J, K, M	BP	50
CDR1 -B-1R8A--	1.8	B, C, D	BG, BP	50	CDR1 -B-151A--	150	F, G, J, K, M	BP	50
CDR1 -B-1R9A--	1.9	B, C, D	BG, BP	50	CDR1 -B-161A--	160	F, G, J, K, M	BP	50
CDR1 -B-2R0A--	2.0	B, C, D	BG, BP	50	CDR1 -B-181A--	180	F, G, J, K, M	BP	50
CDR1 -B-2R1A--	2.1	B, C, D	BG, BP	50	CDR1 -B-201A--	200	F, G, J, K, M	BP	50
CDR1 -B-2R2A--	2.2	B, C, D	BG, BP	50	CDR1 -B-221A--	220	F, G, J, K, M	BP	50
CDR1 -B-2R4A--	2.4	B, C, D	BG, BP	50	CDR1 -B-241A--	240	F, G, J, K, M	BP	50
CDR1 -B-2R7A--	2.7	B, C, D	BG, BP	50	CDR1 -B-271A--	270	F, G, J, K, M	BP	50
CDR1 -B-3R0A--	3.0	B, C, D	BG, BP	50	CDR1 -B-301A--	300	F, G, J, K, M	BP	50
CDR1 -B-3R3A--	3.3	B, C, D	BG, BP	50	CDR1 -B-331A--	330	F, G, J, K, M	BP	50
CDR1 -B-3R6A--	3.6	B, C, D	BG, BP	50	CDR1 -B-361A--	360	F, G, J, K, M	BP	50
CDR1 -B-3R9A--	3.9	B, C, D	BG, BP	50	CDR1 -B-391A--	390	F, G, J, K, M	BP	50
CDR1 -B-4R3A--	4.3	B, C, D	BG, BP	50	CDR1 -B-431A--	430	F, G, J, K, M	BP	50
CDR1 -B-4R7A--	4.7	B, C, D	BG, BP	50	CDR1 -B-471A--	470	F, G, J, K, M	BP	50
CDR1 -B-5R1A--	5.1	B, C, D	BG, BP	50	CDR1 -B-511A--	510	F, G, J, K, M	BP	50
CDR1 -B-5R6A--	5.6	B, C, D	BG, BP	50	CDR1 -B-561A--	560	F, G, J, K, M	BP	50
CDR1 -B-6R2A--	6.2	B, C, D	BG, BP	50	CDR1 -B-621A--	620	F, G, J, K, M	BP	50
CDR1 -B-6R8A--	6.8	B, C, J, K, M	BG, BP	50	CDR1 -B-681A--	680	F, G, J, K, M	BP	50
CDR1 -B-7R5A--	7.5	B, C, J, K, M	BG, BP	50	CDR1 -B-751A--	750	F, G, J, K, M	BP	50
CDR1 -B-8R2A--	8.2	B, C, J, K, M	BG, BP	50	CDR1 -B-821A--	820	F, G, J, K, M	BP	50
CDR1 -B-9R1A--	9.1	B, C, J, K, M	BG, BP	50	CDR1 -B-911A--	910	F, G, J, K, M	BP	50
CDR1 -B-100A--	10	F, G, J, K, M	BG, BP	50	CDR1 -B-102A--	1000	F, G, J, K, M	BP	50
CDR1 -B-110A--	11	F, G, J, K, M	BG, BP	50					
CDR1 -B-120A--	12	F, G, J, K, M	BG, BP	50					
CDR1 -B-130A--	13	F, G, J, K, M	BG, BP	50					
CDR1 -B-150A--	15	F, G, J, K, M	BG, BP	50					
CDR1 -B-160A--	16	F, G, J, K, M	BG, BP	50					
CDR1 -B-180A--	18	F, G, J, K, M	BG, BP	50					
CDR1 -B-200A--	20	F, G, J, K, M	BG, BP	50					
CDR1 -B-220A--	22	F, G, J, K, M	BG, BP	50					
CDR1 -B-240A--	24	F, G, J, K, M	BG, BP	50					
CDR1 -B-270A--	27	F, G, J, K, M	BG, BP	50					

1/Complete type designation will include additional symbols to indicate style, voltage-temperature limits, capacitance tolerance (where applicable), termination finish ("M" or "N" for style CDR11, and "S", "U" or "W" for style CDR12) and failure rate level.

Microwave MLC's



CDR Series — MIL-PRF-55681 (RF/Microwave Chips)

TABLE II: STYLES CDR13 AND CDR14 CAPACITOR CHARACTERISTICS

Type Designation 1/	Capacitance in pF	Capacitance tolerance	Rated temperature and V/Temperature	WVDC	Type Designation 1/	Capacitance in pF	Capacitance tolerance	Rated temperature and V/Temperature	WVDC
CDR1 -B-0R1*B--	0.1	B	BG, BP	200/500	CDR1 -B-560*---	56	F, G, J, K, M	BG, BP	200/500
CDR1 -B-0R2*B--	0.2	B	BG, BP	200/500	CDR1 -B-620*---	62	F, G, J, K, M	BG, BP	200/500
CDR1 -B-0R3*---	0.3	B, C	BG, BP	200/500	CDR1 -B-680*---	68	F, G, J, K, M	BG, BP	200/500
CDR1 -B-0R4*---	0.4	B, C	BG, BP	200/500	CDR1 -B-750*---	75	F, G, J, K, M	BG, BP	200/500
CDR1 -B-0R5*---	0.5	B, C, D	BG, BP	200/500	CDR1 -B-820*---	82	F, G, J, K, M	BG, BP	200/500
CDR1 -B-0R6*---	0.6	B, C, D	BG, BP	200/500	CDR1 -B-910*---	91	F, G, J, K, M	BG, BP	200/500
CDR1 -B-0R7*---	0.7	B, C, D	BG, BP	200/500	CDR1 -B-101*---	100	F, G, J, K, M	BG, BP	200/500
CDR1 -B-0R8*---	0.8	B, C, D	BG, BP	200/500	CDR1 -B-111‡--	110	F, G, J, K, M	BG, BP	200/300
CDR1 -B-0R9*---	0.9	B, C, D	BG, BP	200/500	CDR1 -B-121‡--	120	F, G, J, K, M	BG, BP	200/300
CDR1 -B-1R0*---	1.0	B, C, D	BG, BP	200/500	CDR1 -B-131‡--	130	F, G, J, K, M	BG, BP	200/300
CDR1 -B-1R1*---	1.1	B, C, D	BG, BP	200/500	CDR1 -B-151‡--	150	F, G, J, K, M	BG, BP	200/300
CDR1 -B-1R2*---	1.2	B, C, D	BG, BP	200/500	CDR1 -B-161‡--	160	F, G, J, K, M	BG, BP	200/300
CDR1 -B-1R3*---	1.3	B, C, D	BG, BP	200/500	CDR1 -B-181‡--	180	F, G, J, K, M	BG, BP	200/300
CDR1 -B-1R4*---	1.4	B, C, D	BG, BP	200/500	CDR1 -B-201‡--	200	F, G, J, K, M	BG, BP	200/300
CDR1 -B-1R5*---	1.5	B, C, D	BG, BP	200/500	CDR1 -B-221C---	220	F, G, J, K, M	BG, BP	200
CDR1 -B-1R6*---	1.6	B, C, D	BG, BP	200/500	CDR1 -B-241C---	240	F, G, J, K, M	BG, BP	200
CDR1 -B-1R7*---	1.7	B, C, D	BG, BP	200/500	CDR1 -B-271C---	270	F, G, J, K, M	BG, BP	200
CDR1 -B-1R8*---	1.8	B, C, D	BG, BP	200/500	CDR1 -B-301C---	300	F, G, J, K, M	BG, BP	200
CDR1 -B-1R9*---	1.9	B, C, D	BG, BP	200/500	CDR1 -B-331C---	330	F, G, J, K, M	BG, BP	200
CDR1 -B-2R0*---	2.0	B, C, D	BG, BP	200/500	CDR1 -B-361C---	360	F, G, J, K, M	BG, BP	200
CDR1 -B-2R1*---	2.1	B, C, D	BG, BP	200/500	CDR1 -B-391C---	390	F, G, J, K, M	BG, BP	200
CDR1 -B-2R2*---	2.2	B, C, D	BG, BP	200/500	CDR1 -B-431C---	430	F, G, J, K, M	BG, BP	200
CDR1 -B-2R4*---	2.4	B, C, D	BG, BP	200/500	CDR1 -B-471C---	470	F, G, J, K, M	BG, BP	200
CDR1 -B-2R7*---	2.7	B, C, D	BG, BP	200/500	CDR1 -B-511B---	510	F, G, J, K, M	BG, BP	100
CDR1 -B-3R0*---	3.0	B, C, D	BG, BP	200/500	CDR1 -B-561B---	560	F, G, J, K, M	BG, BP	100
CDR1 -B-3R3*---	3.3	B, C, D	BG, BP	200/500	CDR1 -B-621B---	620	F, G, J, K, M	BG, BP	100
CDR1 -B-3R6*---	3.6	B, C, D	BG, BP	200/500	CDR1 -B-681A---	680	F, G, J, K, M	BG, BP	50
CDR1 -B-3R9*---	3.9	B, C, D	BG, BP	200/500	CDR1 -B-751A---	750	F, G, J, K, M	BG, BP	50
CDR1 -B-4R3*---	4.3	B, C, D	BG, BP	200/500	CDR1 -B-821A---	820	F, G, J, K, M	BG, BP	50
CDR1 -B-4R7*---	4.7	B, C, D	BG, BP	200/500	CDR1 -B-911A---	910	F, G, J, K, M	BG, BP	50
CDR1 -B-5R1*---	5.1	B, C, D	BG, BP	200/500	CDR1 -B-102A---	1000	F, G, J, K, M	BG, BP	50
CDR1 -B-5R6*---	5.6	B, C, D	BG, BP	200/500	CDR1 -B-112A---	1100	F, G, J, K, M	BP	50
CDR1 -B-6R2*---	6.2	B, C, D	BG, BP	200/500	CDR1 -B-122A---	1200	F, G, J, K, M	BP	50
CDR1 -B-6R8*---	6.8	B, C, J, K, M	BG, BP	200/500	CDR1 -B-132A---	1300	F, G, J, K, M	BP	50
CDR1 -B-7R5*---	7.5	B, C, J, K, M	BG, BP	200/500	CDR1 -B-152A---	1500	F, G, J, K, M	BP	50
CDR1 -B-8R2*---	8.2	B, C, J, K, M	BG, BP	200/500	CDR1 -B-162A---	1600	F, G, J, K, M	BP	50
CDR1 -B-9R1*---	9.1	B, C, J, K, M	BG, BP	200/500	CDR1 -B-182A---	1800	F, G, J, K, M	BP	50
CDR1 -B-100*---	10	F, G, J, K, M	BG, BP	200/500	CDR1 -B-202A---	2000	F, G, J, K, M	BP	50
CDR1 -B-110*---	11	F, G, J, K, M	BG, BP	200/500	CDR1 -B-222A---	2200	F, G, J, K, M	BP	50
CDR1 -B-120*---	12	F, G, J, K, M	BG, BP	200/500	CDR1 -B-242A---	2400	F, G, J, K, M	BP	50
CDR1 -B-130*---	13	F, G, J, K, M	BG, BP	200/500	CDR1 -B-272A---	2700	F, G, J, K, M	BP	50
CDR1 -B-150*---	15	F, G, J, K, M	BG, BP	200/500	CDR1 -B-302A---	3000	F, G, J, K, M	BP	50
CDR1 -B-160*---	16	F, G, J, K, M	BG, BP	200/500	CDR1 -B-332A---	3300	F, G, J, K, M	BP	50
CDR1 -B-180*---	18	F, G, J, K, M	BG, BP	200/500	CDR1 -B-362A---	3600	F, G, J, K, M	BP	50
CDR1 -B-200*---	20	F, G, J, K, M	BG, BP	200/500	CDR1 -B-392A---	3900	F, G, J, K, M	BP	50
CDR1 -B-220*---	22	F, G, J, K, M	BG, BP	200/500	CDR1 -B-432A---	4300	F, G, J, K, M	BP	50
CDR1 -B-240*---	24	F, G, J, K, M	BG, BP	200/500	CDR1 -B-472A---	4700	F, G, J, K, M	BP	50
CDR1 -B-270*---	27	F, G, J, K, M	BG, BP	200/500	CDR1 -B-502A---	5000	F, G, J, K, M	BP	50
CDR1 -B-300*---	30	F, G, J, K, M	BG, BP	200/500	CDR1 -B-512A---	5100	F, G, J, K, M	BP	50
CDR1 -B-330*---	33	F, G, J, K, M	BG, BP	200/500					
CDR1 -B-360*---	36	F, G, J, K, M	BG, BP	200/500					
CDR1 -B-390*---	39	F, G, J, K, M	BG, BP	200/500					
CDR1 -B-430*---	43	F, G, J, K, M	BG, BP	200/500					
CDR1 -B-470*---	47	F, G, J, K, M	BG, BP	200/500					
CDR1 -B-510*---	51	F, G, J, K, M	BG, BP	200/500					

1/Complete type designation will include additional symbols to indicate style, voltage-temperature limits, capacitance tolerance (where applicable), termination finish ("M" or "N" for style CDR13, and "S", "U" or "W" for style CDR14) and failure rate level.

*C=200V; E=500V.

‡C=200V; D=300V.



Performance Curves

TYPICAL Q vs. FREQUENCY
AQ11/12
MIL-PRF-55681E - BG
STANDARD - M

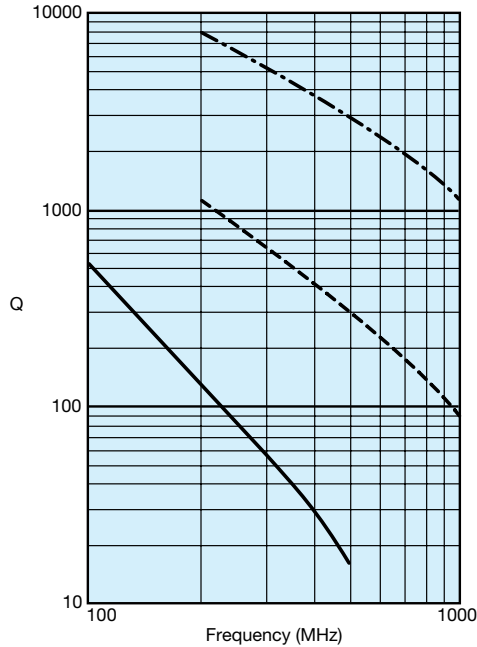

AVX CORPORATION
 - - - 1 Picofarad - - - 10 Picofarad — 100 Picofarad

TYPICAL ESR vs. FREQUENCY
AQ11/12
MIL-PRF-55681E - BG
STANDARD - M

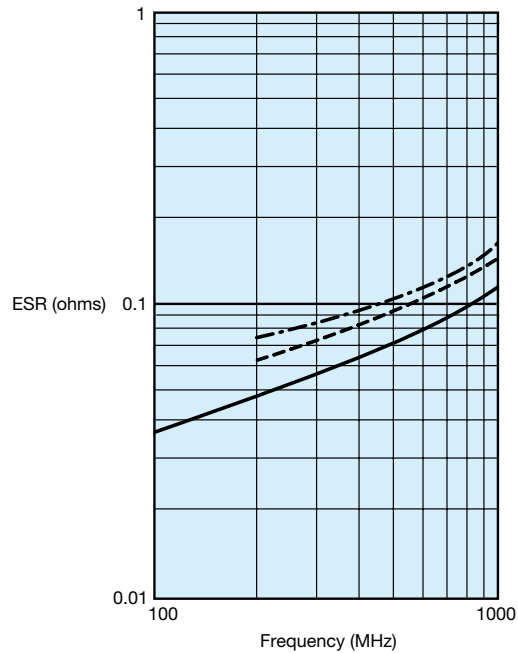

AVX CORPORATION
 - - - 3.3 Picofarad - - - 10 Picofarad — 100 Picofarad

TYPICAL Q vs. CAPACITANCE
AQ11/12
MIL-PRF-55681E - BG
STANDARD - M

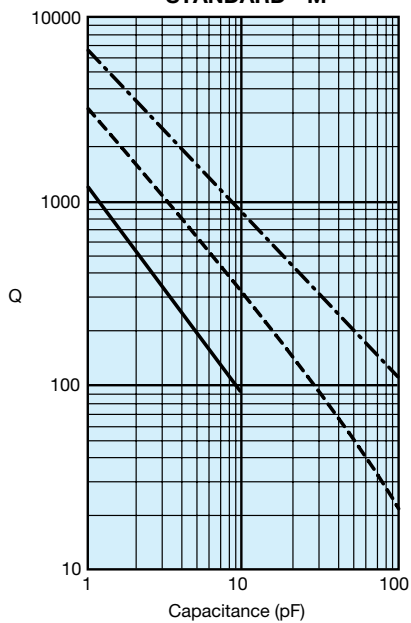

AVX CORPORATION
 - - - 250 MHz - - - 500 MHz — 1000 MHz

TYPICAL ESR vs. CAPACITANCE
AQ11/12
MIL-PRF-55681E - BG
STANDARD - M

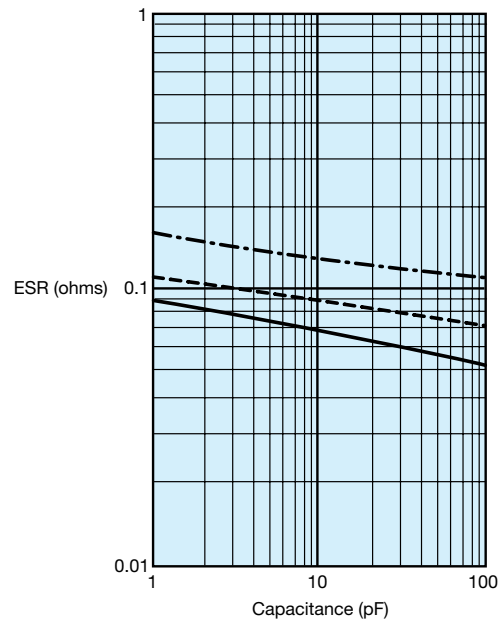

AVX CORPORATION
 — 250 MHz - - - 500 MHz - - - 1000 MHz

Performance Curves

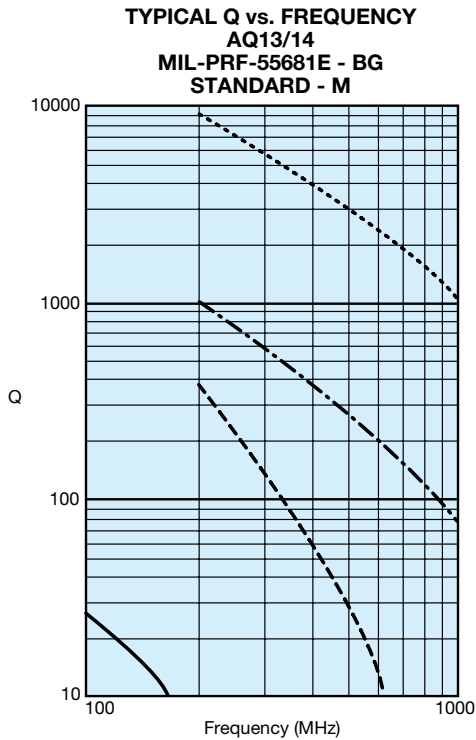

AVX CORPORATION
 - - - - 1 Picofarad - - - - 10 Picofarad - - - - 47 Picofarad ——— 330 Picofarad

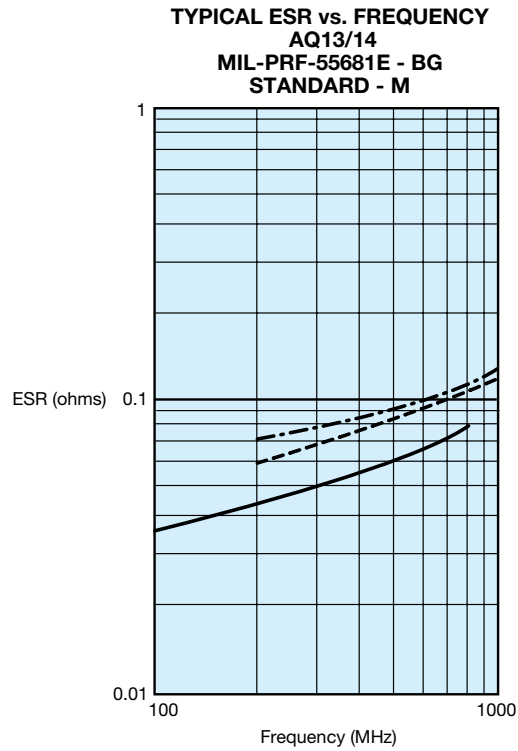

AVX CORPORATION
 - - - - 1 Picofarad - - - - 15 Picofarad ——— 100 Picofarad

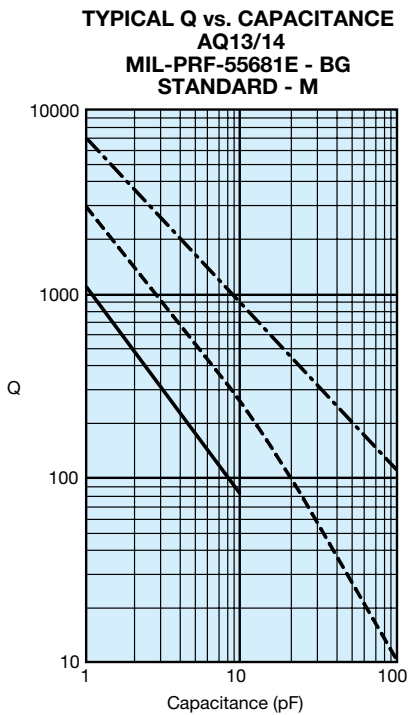

AVX CORPORATION
 - - - - 250 MHz - - - - 500 MHz ——— 1000 MHz

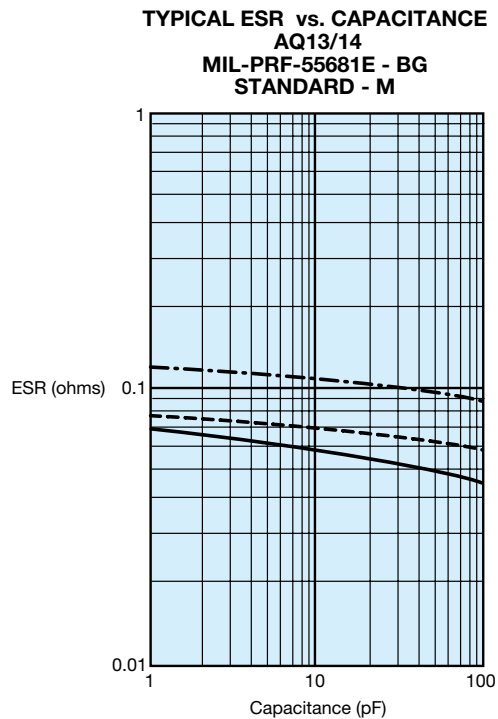

AVX CORPORATION
 ——— 250 MHz - - - - 500 MHz - - - - 1000 MHz

6

Performance Curves

TYPICAL Q vs. FREQUENCY
AQ11/12
MIL-PRF-55681E - BP
STANDARD - A

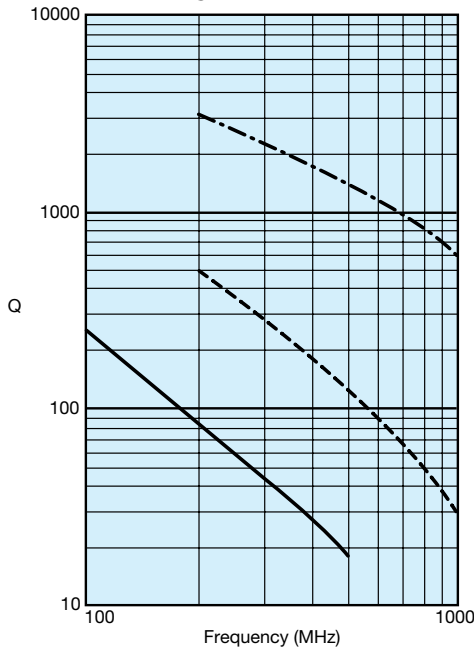

AVX CORPORATION
--- 1 Picofarad - - - 15 Picofarad — 100 Picofarad

TYPICAL ESR vs. FREQUENCY
AQ11/12
MIL-PRF-55681E - BP
STANDARD - A

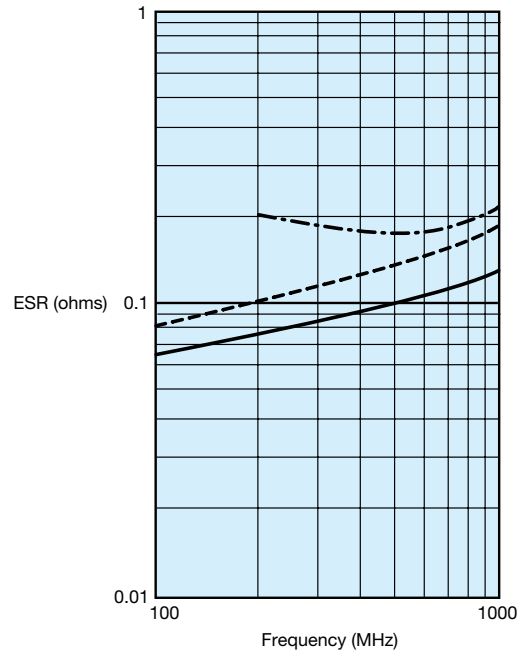

AVX CORPORATION
--- 1 Picofarad - - - 15 Picofarad — 100 Picofarad

TYPICAL Q vs. CAPACITANCE
AQ11/12
MIL-PRF-55681E - BP
STANDARD - A

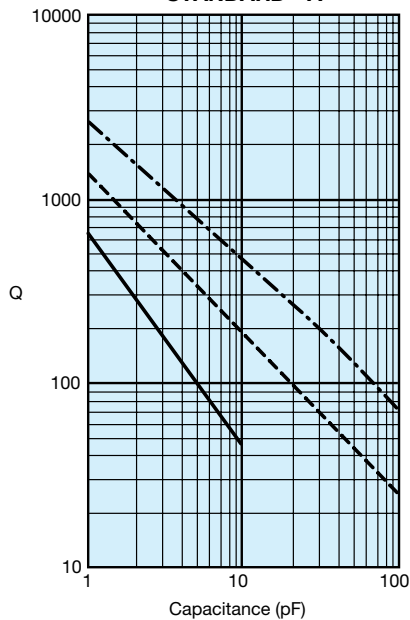

AVX CORPORATION
--- 250 MHz - - - 500 MHz — 1000 MHz

TYPICAL ESR vs. CAPACITANCE
AQ11/12
MIL-PRF-55681E - BP
STANDARD - A

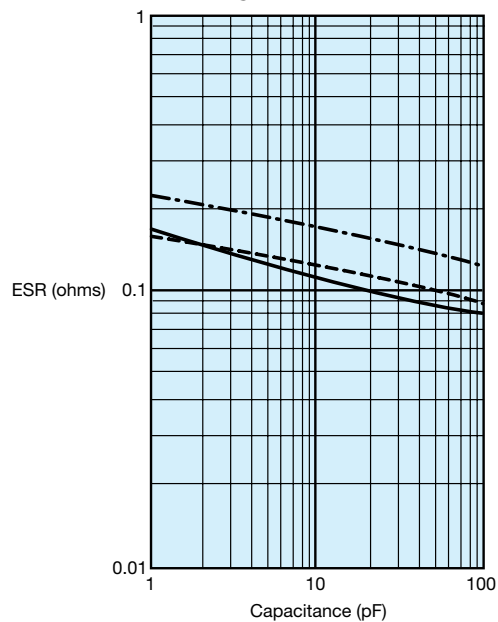

AVX CORPORATION
--- 250 MHz - - - 500 MHz — 1000 MHz

Performance Curves

TYPICAL Q vs. FREQUENCY
AQ13/14
MIL-PRF-55681E - BP
STANDARD - A

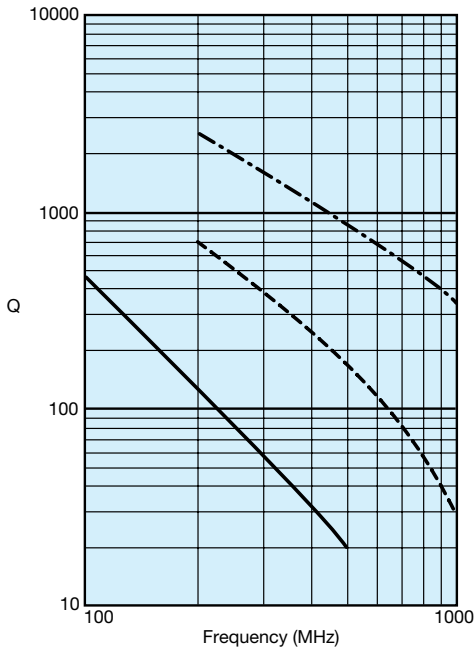

AVX CORPORATION
 - - - 2 Picofarad - - - 15 Picofarad — 100 Picofarad

TYPICAL ESR vs. FREQUENCY
AQ13/14
MIL-PRF-55681E - BP
STANDARD - A

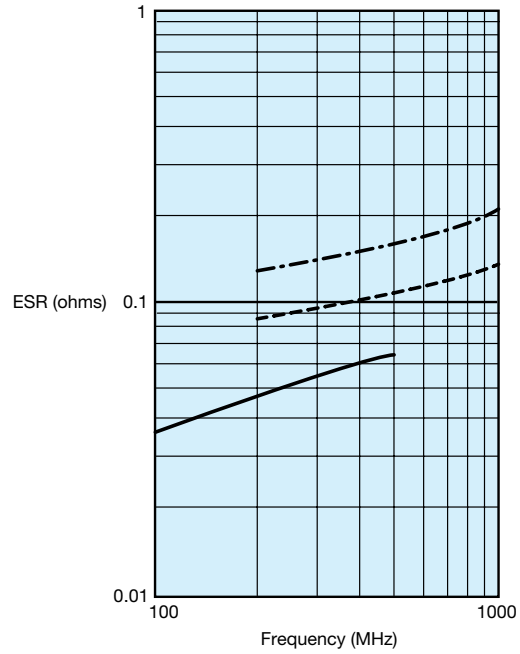

AVX CORPORATION
 - - - 15 Picofarad - - - 47 Picofarad — 100 Picofarad

TYPICAL Q vs. CAPACITANCE
AQ13/14
MIL-PRF-55681E - BP
STANDARD - A

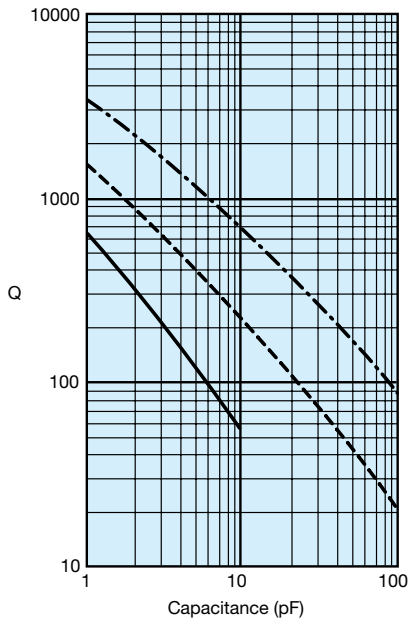

AVX CORPORATION
 - - - 250 MHz - - - 500 MHz — 1000 MHz

TYPICAL ESR vs. CAPACITANCE
AQ13/14
MIL-PRF-55681E - BP
STANDARD - A

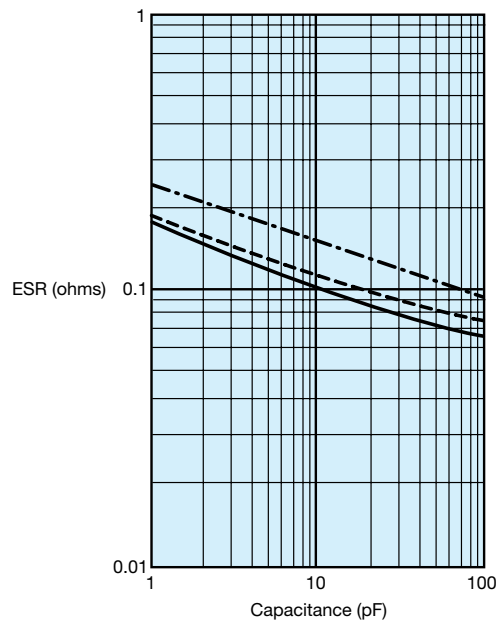

AVX CORPORATION
 — 250 MHz - - - 500 MHz - - - 1000 MHz

**TYPICAL RESONANT FREQUENCY vs. CAPACITANCE
AVX AQ11-14 (CDR11-14)**

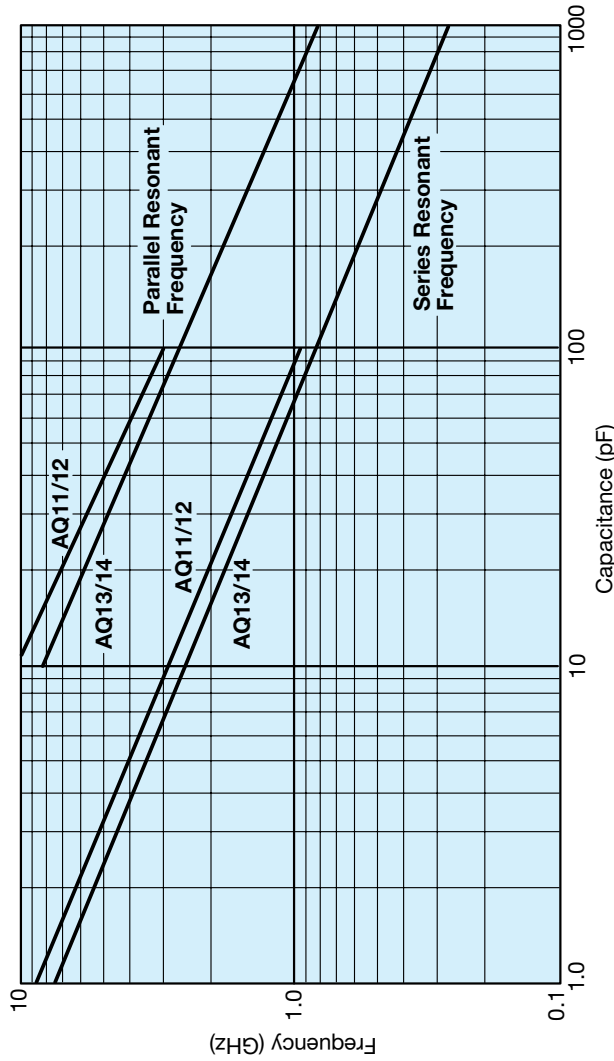

**TYPICAL RESONANT FREQUENCY vs. CAPACITANCE
AVX 0603**

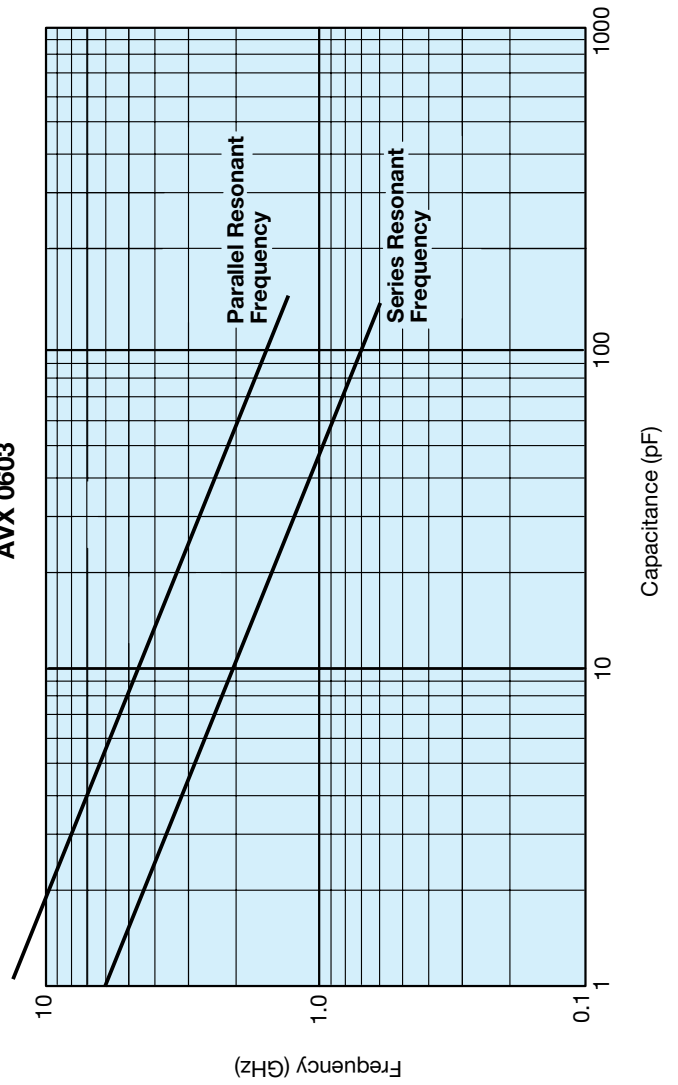

Microwave MLC's

Automatic Insertion Packaging



TAPE & REEL: All tape and reel specifications are in compliance with EIA RS481 (equivalent to IEC 286 part 3).

Sizes AQ11/12 through 13/14, CDR11/12 through 13/14.

“U” Series - 0603/0805/1210 Size Chips

—8mm carrier

—8mm carrier

—7" reel: ≤ 0.040 " thickness = 2000 pcs

—7" reel: 0603 & 0805 ≤ 0.40 " thickness = 4000 pcs

≤ 0.075 " thickness = 2000 pcs

0805 . 0.040" thickness & 1210= 2000 pcs

—13" reel: ≤ 0.075 " thickness = 10,000 pcs

—13" reel: ≤ 0.075 " thickness = 10,000 pcs

REEL DIMENSIONS: millimeters (inches)

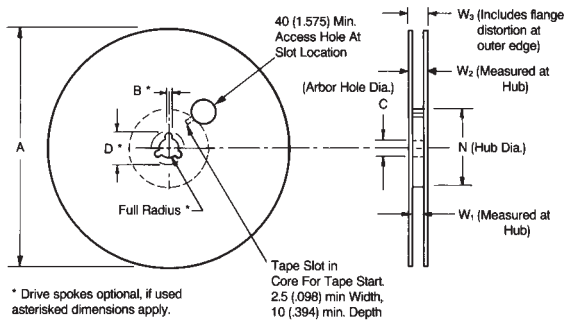

Tape Size ⁽¹⁾	A Max.	B* Min.	C	D* Min.	N Min.	W ₁	W ₂ Max.	W ₃
8mm	330 (12.992)	1.5 (.059)	13.0±0.20 (.512±.008)	20.2 (.795)	50 (1.969)	8.4 ^{+1.0} / _{-0.0} (.331 ^{+0.060} / _{-0.0})	14.4 (.567)	7.9 Min. (.311) 10.9 Max. (.429)
12mm						12.4 ^{+2.0} / _{-0.0} (.488 ^{+0.075} / _{-0.0})	18.4 (.724)	11.9 Min. (.469) 15.4 Max. (.607)

Metric dimensions will govern.

English measurements rounded and for reference only.

(1) For tape sizes 16mm and 24mm (used with chip size 3640) consult EIA RS-481 latest revision.

EMBOSSED CARRIER CONFIGURATION

8 & 12 MM TAPE ONLY

CONSTANT DIMENSIONS

Tape Size	D ₀	E	P ₀	P ₂	T Max.	T ₁	G ₁	G ₂
8mm and 12mm	8.4 ^{+0.10} / _{-0.0} (.059 ^{+0.004} / _{-0.0})	1.75 ± 0.10 (.069 ± .004)	4.0 ± 0.10 (.157 ± .004)	2.0 ± 0.05 (.079 ± .002)	0.600 (.024)	0.10 Max. (.004)	0.75 Min. (.030)	0.75 Min. (.030)

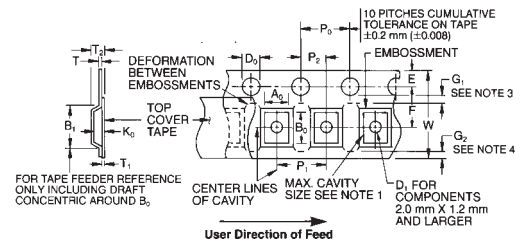

VARIABLE DIMENSIONS

Tape Size	B ₁ Max. See Note 6	D ₁ Min. See Note 5	F	P ₁	R Min. See Note 2	T ₂	W	A ₀ B ₀ K ₀
8mm	4.55 (.179)	1.0 (.039)	3.5 ± 0.05 (.138 ± .002)	4.0 ± 0.10 (.157 ± .004)	25 (.984)	2.5 Max (.098)	8.0 ^{+0.3} / _{-0.1} (.315 ^{+0.012} / _{-0.004})	See Note 1
12mm	8.2 (.323)	1.5 (.059)	5.5 ± 0.05 (.217 ± .002)	4.0 ± 0.10 (.157 ± .004)	30 (1.181)	6.5 Max (.256)	12.0 ± .30 (.472 ± .012)	See Note 1

NOTES:

- A₀, B₀, and K₀ are determined by the max. dimensions to the ends of the terminals extending from the component body and/or the body dimensions of the component. The clearance between the end of the terminals or body of the component to the sides and depth of the cavity (A₀, B₀, and K₀) must be within 0.05 mm (.002) min. and 0.50 mm (.020) max. The clearance allowed must also prevent rotation of the component within the cavity of not more than 20 degrees (see sketches C & D).
- Tape with components shall pass around radius “R” without damage. The minimum trailer length (Note 2 Fig. 3) may require additional length to provide R min. for 12mm embossed tape for reels with hub diameters approaching N min. (Table 4).

- G₁ dimension is the flat area from the edge of the sprocket hole to either the outward deformation of the carrier tape between the embossed cavities or to the edge of the cavity whichever is less.
- G₂ dimension is the flat area from the edge of the carrier tape opposite the sprocket holes to either the outward deformation of the carrier tape between the embossed cavity or to the edge of the cavity whichever is less.
- The embossment hole location shall be measured from the sprocket hole controlling the location of the embossment. Dimensions of embossment location and hole location shall be applied independent of each other.
- B₁ dimension is a reference dimension for tape feeder clearance only.

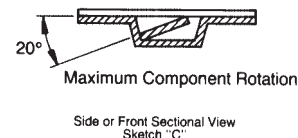
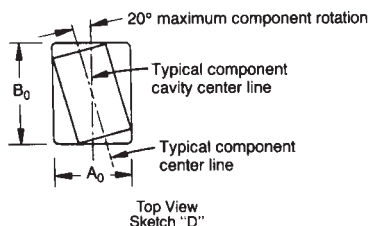

Hi-Q[®] High RF Power MLC Surface Mount Capacitors

For 600V to 4000V Application



PRODUCT OFFERING

Hi-Q[®], high RF power, surface mount MLC capacitors from AVX Corporation are characterized with ultra-low ESR and dissipation factor at high frequencies. They are designed to handle high power and high voltage levels for applications in RF power amplifiers, inductive heating, high magnetic field environments (MRI coils), medical and industrial electronics.

HOW TO ORDER

HQCC	A	A	271	J	A	T	1	A
AVX Style	Voltage	Temperature Coefficient	Capacitance Code	Capacitance Tolerance	Test Level	Termination	Packaging	Special Code
HQCC	600V = C 1000V = A 1500V = S 2000V = G 2500V = W 3000V = H 4000V = J	COG = A	(2 significant digits + no. of zeros) Examples: 10 pF = 100 100 pF = 101 1,000 pF = 102 22,000 pF = 223	F = ±1% G = ±2% J = ±5% K = ±10% M = ±20%	A = Standard	1 = Pd/Ag T = Solderable Plate	1 = 7" Reel 3 = 13" Reel 9 = Bulk	A = Standard

DIMENSIONS

millimeters (inches)

STYLE	HQCC	HQCE
(L) Length	5.84 ± 0.51 (0.230 ± 0.020)	9.4 ± 0.51 (0.370 ± 0.020)
(W) Width	6.35 ± 0.51 (0.250 ± 0.020)	9.9 ± 0.51 (0.390 ± 0.020)
(T) Thickness Max.	3.3 max. (0.130 max.)	3.3 max. (0.130 max.)
(t) terminal	0.64 ± 0.38 (0.025 ± 0.015)	0.64 ± 0.38 (0.025 ± 0.015)

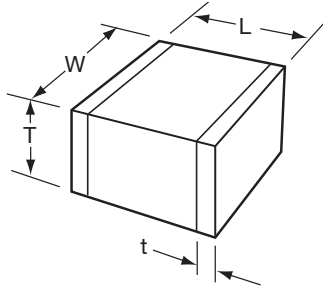

DIELECTRIC PERFORMANCE CHARACTERISTICS

Capacitance Range	10pF to 6,800pF (25°C, 1.0 ±0.2 Vrms at 1kHz, for ≤ 1000 pF use 1MHz)
Capacitance Tolerances	±1%, ±2%, ±5%, ±10%, ±20%
Dissipation Factor 25°C	0.1% Max (+25°C, 1.0 ±0.2 Vrms at 1kHz, for ≤ 1000 pF use 1MHz)
Operating Temperature Range	-55°C to +125°C
Temperature Characteristic	COG: 0 ± 30 ppm/°C (-55°C to +125°C)
Voltage Ratings	600, 1000, 1500, 2000, 2500, 3000, 4000VDC
Insulation Resistance	100K MΩ min. @ +25°C and 500VDC 10K MΩ min. @ +125°C and 500VDC
Dielectric Strength	120% of rated WVDC

HIGH VOLTAGE CAPACITANCE VALUES (pF)

Style	600 WDC min./max.	1000 WVDC min./max.	1500 WVDC min./max.	2000 WVDC min./max.	2500 WVDC min./max.	3000 WVDC min./max.	4000 WVDC min./max.
HQCC	2,200 - 2,700	1,500 - 1,800	820 - 1,200	470 - 680	330 - 390	10 - 270	
HQCE	5,600 - 6,800	3,300 - 4,700	2,200 - 2,700	1,200 - 1,800	820 - 1,000	470-680	10-390



RF/Microwave NP0 Capacitors

“U” Series
Ceramic C0G (NP0) Microwave
Multilayer Capacitors

RF/Microwave COG (NP0) Capacitors

Ultra Low ESR, “U” Series, COG (NP0) Chip Capacitors

GENERAL INFORMATION

“U” Series capacitors are COG (NP0) chip capacitors specially designed for “Ultra” low ESR for applications in the communications market. Max ESR and effective capacitance

are met on each value producing lot to lot uniformity. Sizes available are EIA chip sizes 0603, 0805, and 1210.

DIMENSIONS: inches (millimeters)

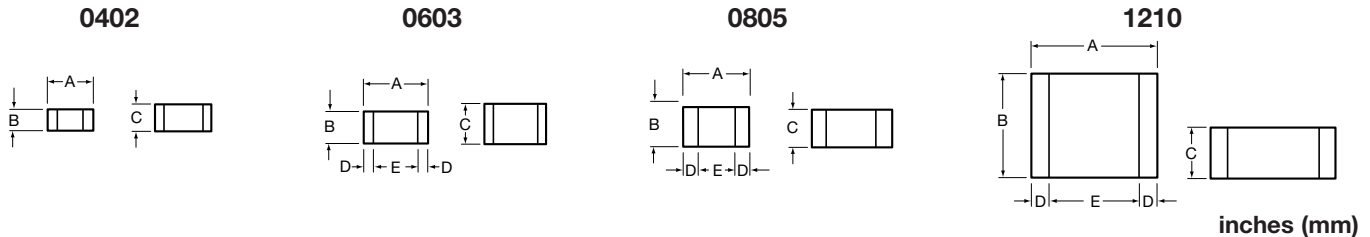

Size	A	B	C	D	E
0402	0.039±0.004 (1.00±0.1)	0.020±0.004 (0.50±0.1)	0.024 (0.6) max	N/A	N/A
0603	0.060±0.010 (1.52±0.25)	0.030±0.010 (0.76±0.25)	0.036 (0.91) max	0.010±0.005 (0.25±0.13)	0.030 (0.76) min
0805	0.079±0.008 (2.01±0.2)	0.049±0.008 (1.25±0.2)	0.040±0.005 (1.02±0.127)	0.020±0.010 (0.51±0.254)	0.020 (0.51) min
1210	0.126±0.008 (3.2±0.2)	0.098±0.008 (2.49±0.2)	0.050±0.005 (1.27±0.127)	0.025±0.015 (0.635±0.381)	0.040 (1.02) min

HOW TO ORDER

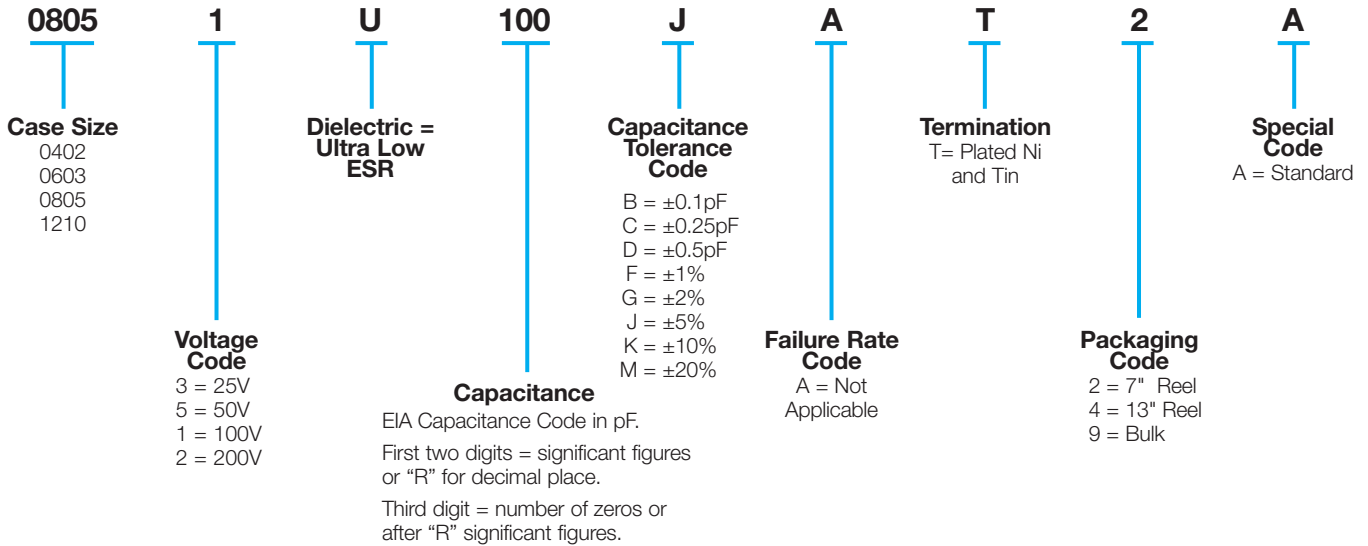

ELECTRICAL CHARACTERISTICS

Capacitance Values and Tolerances:

- Size 0402 - 0.2 pF to 22 pF @ 1 MHz
- Size 0603 - 1.0 pF to 100 pF @ 1 MHz
- Size 0805 - 1.6 pF to 160 pF @ 1 MHz
- Size 1210 - 2.4 pF to 1000 pF @ 1 MHz

Temperature Coefficient of Capacitance (TC):

0±30 ppm/°C (-55° to +125°C)

Insulation Resistance (IR):

- 10¹² Ω min. @ 25°C and rated WVDC
- 10¹¹ Ω min. @ 125°C and rated WVDC

Working Voltage (WVDC):

- Size Working Voltage
- 0402 - 50, 25 WVDC
- 0603 - 200, 100, 50 WVDC
- 0805 - 200, 100 WVDC
- 1210 - 200, 100 WVDC

Dielectric Working Voltage (DWV):

250% of rated WVDC

Equivalent Series Resistance Typical (ESR):

- 0402 - See Performance Curve, page 92
- 0603 - See Performance Curve, page 92
- 0805 - See Performance Curve, page 92
- 1210 - See Performance Curve, page 92

Marking: Laser marking EIA J marking standard (except 0603) (capacitance code and tolerance upon request).

MILITARY SPECIFICATIONS

Meets or exceeds the requirements of MIL-C-55681



RF/Microwave C0G (NP0) Capacitors



Ultra Low ESR, "U" Series, C0G (NP0) Chip Capacitors

CAPACITANCE RANGE

Cap (pF)	Available	Size			
	Tolerance	0402	0603	0805	1210
0.2	B,C	50V	N/A	N/A	N/A
0.3	↑	↓	↓	↓	↓
0.4	B,C	↓	↓	↓	↓
0.5	B,C	↓	↓	↓	↓
0.6	B,C,D	↓	↓	↓	↓
0.7	↑	↓	↓	↓	↓
0.8	B,C,D	↓	↓	↓	↓
0.9	↓	↓	↓	↓	↓

Cap (pF)	Available	Size			
	Tolerance	0402	0603	0805	1210
1.0	B,C,D	50V	200V	200V	200V
1.1	↑	↓	↓	↓	↓
1.2	B,C,D	↓	↓	↓	↓
1.3	↑	↓	↓	↓	↓
1.4	B,C,D	↓	↓	↓	↓
1.5	↑	↓	↓	↓	↓
1.6	B,C,D	↓	↓	↓	↓
1.7	↑	↓	↓	↓	↓
1.8	B,C,D	↓	↓	↓	↓
1.9	↑	↓	↓	↓	↓
2.0	B,C,D	↓	↓	↓	↓
2.1	↑	↓	↓	↓	↓
2.2	B,C,D	↓	↓	↓	↓
2.4	↑	↓	↓	↓	↓
2.7	B,C,D	↓	↓	↓	↓
3.0	↑	↓	↓	↓	↓
3.3	B,C,D	↓	↓	↓	↓
3.6	↑	↓	↓	↓	↓
3.9	B,C,D	↓	↓	↓	↓
4.3	↑	↓	↓	↓	↓
4.7	B,C,D	↓	↓	↓	↓
5.1	↑	↓	↓	↓	↓
5.6	B,C,D	↓	↓	↓	↓
6.2	↑	↓	↓	↓	↓
6.8	B,C,J,K,M	↓	↓	↓	↓

Cap (pF)	Available	Size			
	Tolerance	0402	0603	0805	1210
7.5	B,C,J,K,M	50V	200V	200V	200V
8.2	↑	↓	↓	↓	↓
9.1	B,C,J,K,M	↓	↓	↓	↓
10	F,G,J,K,M	↓	↓	↓	↓
11	↑	↓	↓	↓	↓
12	B,C,D	↓	↓	↓	↓
13	↑	↓	↓	↓	↓
15	B,C,D	↓	↓	↓	↓
18	↑	↓	↓	↓	↓
20	B,C,D	↓	↓	↓	↓
22	↑	↓	↓	↓	↓
24	B,C,D	↓	↓	↓	↓
27	↑	↓	↓	↓	↓
30	B,C,D	↓	↓	↓	↓
33	↑	↓	↓	↓	↓
36	B,C,D	↓	↓	↓	↓
39	↑	↓	↓	↓	↓
43	B,C,D	↓	↓	↓	↓
47	↑	↓	↓	↓	↓
51	B,C,D	↓	↓	↓	↓
56	↑	↓	↓	↓	↓
68	B,C,D	↓	↓	↓	↓
75	↑	↓	↓	↓	↓
82	B,C,D	↓	↓	↓	↓
91	F,G,J,K,M	↓	↓	↓	↓

Cap (pF)	Available	Size			
	Tolerance	0402	0603	0805	1210
100	F,G,J,K,M	N/A	100V	200V	200V
110	↑	↓	↓	↓	↓
120	F,G,J,K,M	↓	↓	↓	↓
130	↑	↓	↓	↓	↓
140	F,G,J,K,M	↓	↓	↓	↓
150	↑	↓	↓	↓	↓
160	F,G,J,K,M	↓	↓	↓	↓
180	↑	↓	↓	↓	↓
200	F,G,J,K,M	↓	↓	↓	↓
220	↑	↓	↓	↓	↓
270	F,G,J,K,M	↓	↓	↓	↓
300	↑	↓	↓	↓	↓
330	F,G,J,K,M	↓	↓	↓	↓
360	↑	↓	↓	↓	↓
390	F,G,J,K,M	↓	↓	↓	↓
430	↑	↓	↓	↓	↓
470	F,G,J,K,M	↓	↓	↓	↓
510	↑	↓	↓	↓	↓
560	F,G,J,K,M	↓	↓	↓	↓
620	↑	↓	↓	↓	↓
680	F,G,J,K,M	↓	↓	↓	↓
750	↑	↓	↓	↓	↓
820	F,G,J,K,M	↓	↓	↓	↓
910	↑	↓	↓	↓	↓
1000	F,G,J,K,M	↓	↓	↓	↓

ULTRA LOW ESR, "U" SERIES

TYPICAL ESR vs. FREQUENCY
0402 "U" SERIES

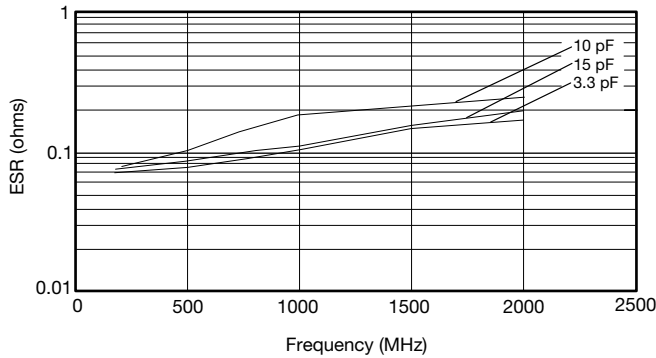

TYPICAL ESR vs. FREQUENCY
0603 "U" SERIES

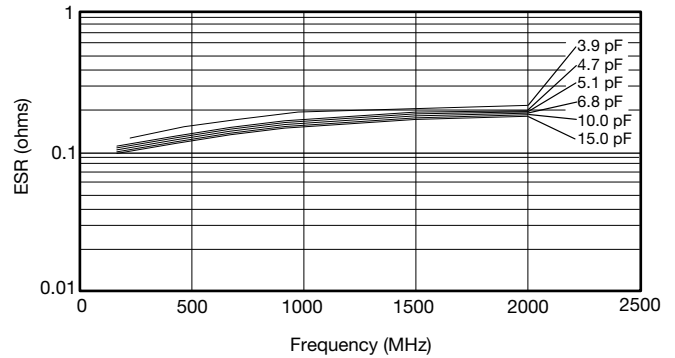

TYPICAL ESR vs. FREQUENCY
0805 "U" SERIES

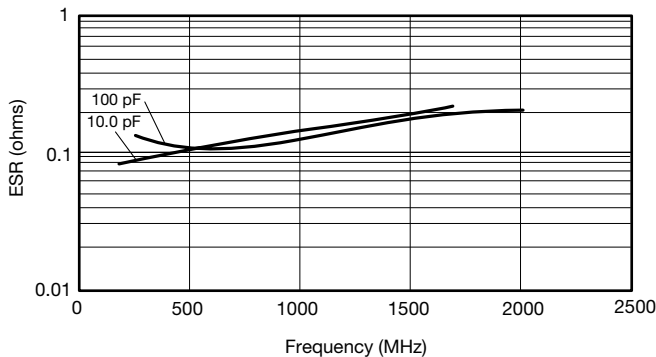

TYPICAL ESR vs. FREQUENCY
1210 "U" SERIES

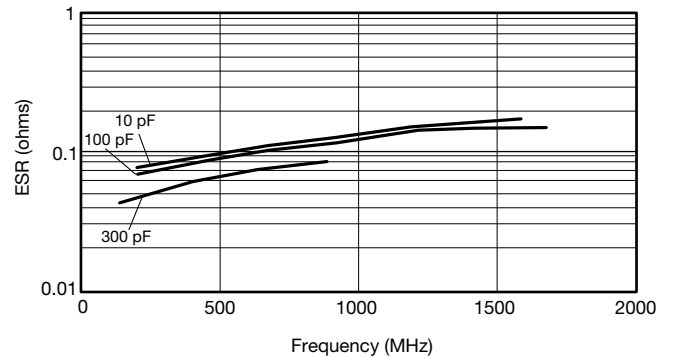

ESR Measured on the Boonton 34A

7



RF/Microwave C0G (NP0) Capacitors



Ultra Low ESR, "U" Series, C0G (NP0) Chip Capacitors

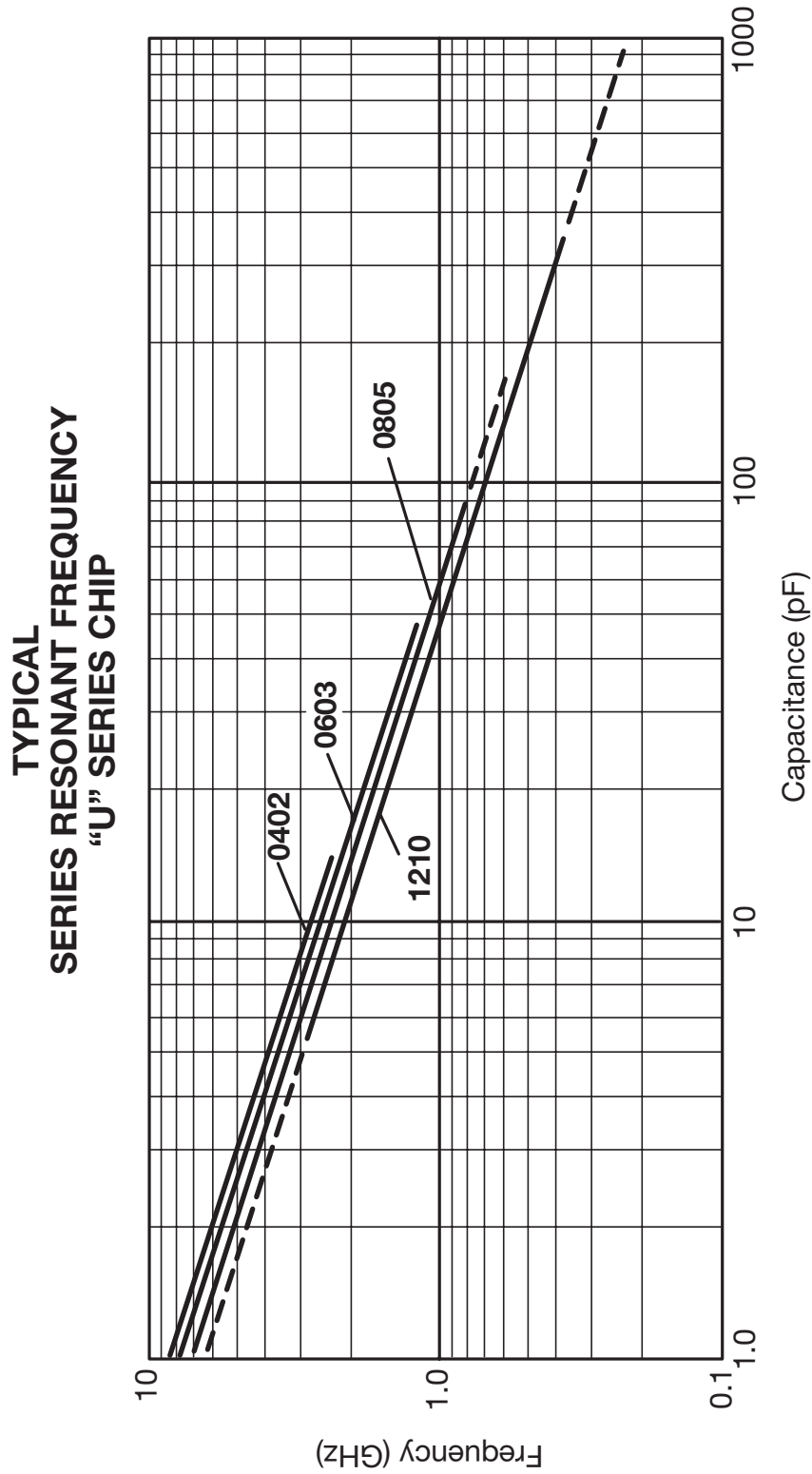



RF/Microwave

AQ 12 & 14 and “U” Series
Designer Kits

Tuning Kits: AQ12/AQ14 Series

TUNING KITS

Solder Plated, Nickel Barrier

Porcelain (+90)

Ceramic (NP0)

AQ12		AQ14		AQ12		AQ14	
Kit 1500 UZ		Kit 2500 UZ		Kit 1501 UZ		Kit 2501 UZ	
Capacitor Value pF	Tolerance*	Capacitor Value pF	Tolerance*	Capacitor Value pF	Tolerance*	Capacitor Value pF	Tolerance*
0.1	B	0.1	B	0.1	B	0.1	B
0.2	B	0.2	B	0.2	B	0.2	B
0.3	B	0.3	B	0.3	B	0.3	B
0.4	B	0.4	B	0.4	B	0.4	B
0.5	B	0.5	B	0.5	B	0.5	B
0.6	B	0.6	B	0.6	B	0.6	B
0.7	B	0.7	B	0.7	B	0.7	B
0.8	B	0.8	B	0.8	B	0.8	B
0.9	B	0.9	B	0.9	B	0.9	B
1.0	B	1.0	B	1.0	B	1.0	B
1.1	B	1.1	B	1.1	B	1.1	B
1.2	B	1.2	B	1.2	B	1.2	B
1.3	B	1.3	B	1.3	B	1.3	B
1.4	B	1.4	B	1.4	B	1.4	B
1.5	B	1.5	B	1.5	B	1.5	B
1.6	B	1.6	B	1.6	B	1.6	B
1.7	B	1.7	B	1.7	B	1.7	B
1.8	B	1.8	B	1.8	B	1.8	B
1.9	B	1.9	B	1.9	B	1.9	B
2.0	B	2.0	B	2.0	B	2.0	B
2.1	B	2.1	B	2.1	B	2.1	B
2.2	B	2.2	B	2.2	B	2.2	B
2.4	B	2.4	B	2.4	B	2.4	B
2.7	B	2.7	B	2.7	B	2.7	B
3.0	B	3.0	B	3.0	B	3.0	B
3.3	C	3.3	C	3.3	C	3.3	C
3.6	C	3.6	C	3.6	C	3.6	C
3.9	C	3.9	C	3.9	C	3.9	C
4.3	C	4.3	C	4.3	C	4.3	C
4.7	C	4.7	C	4.7	C	4.7	C
5.1	C	5.1	C	5.1	C	5.1	C
5.6	C	5.6	C	5.6	C	5.6	C
6.2	C	6.2	C	6.2	C	6.2	C
6.8	J	6.8	J	6.8	J	6.8	J
7.5	J	7.5	J	7.5	J	7.5	J
8.2	J	8.2	J	8.2	J	8.2	J
9.1	J	9.1	J	9.1	J	9.1	J
10.0	J	10.0	J	10.0	J	10.0	J

380 Capacitors 10 each of 38 values. All chips are laser marked.
 *Tolerance: B =±0.1pF, C =±0.25pF, J =±5%.

EVALUATION KITS

Solder Plated, Nickel Barrier

Porcelain (+90)

Ceramic (NP0)

AQ12

AQ14

AQ12

AQ14

Kit 1000 UZ	
Capacitor Value pF	Tolerance*
.5	B
1.0	B
1.2	B
1.5	B
1.8	B
2.0	B
2.2	B
2.4	C
2.7	C
3.0	C
3.3	C
3.6	C
3.9	C
4.3	C
4.7	C
6.8	J
8.2	J
10.0	J
12.0	J
15.0	J
18.0	J
22.0	J
27.0	J
33.0	J
39.0	J
47.0	J
56.0	J
68.0	J
82.0	J
100.0	J

300 Capacitors 10 each of 30 values.
All chips are laser marked.

*Tolerance: B = ± 0.1 pF, C = ± 0.25 pF, J = $\pm 5\%$.

Kit 2000 UZ	
Capacitor Value pF	Tolerance*
1.0	B
1.2	B
1.5	B
1.8	B
2.0	B
2.2	B
2.4	C
2.7	C
3.0	C
3.3	C
3.6	C
3.9	C
4.3	C
4.7	C
5.1	C
5.6	C
6.2	C
6.8	J
8.2	J
10.0	J
12.0	J
15.0	J
18.0	J
22.0	J
27.0	J
33.0	J
39.0	J
47.0	J
56.0	J
68.0	J
82.0	J
100.0	J
120.0	J
150.0	J
180.0	J
220.0	J
240.0	J
270.0	K
330.0	K
390.0	K
470.0	K
560.0	K
680.0	K
820.0	K
1000.0	K

450 Capacitors 10 each of 45 values.
All chips are laser marked.

*Tolerance: B = ± 0.1 pF, C = ± 0.25 pF, J = $\pm 5\%$, K = $\pm 10\%$

Kit 1001 UZ	
Capacitor Value pF	Tolerance*
.5	B
1.0	B
1.5	B
1.8	B
2.0	B
2.2	B
2.4	C
2.7	C
3.0	C
3.3	C
3.6	C
3.9	C
4.3	C
4.7	C
6.8	J
8.2	J
10.0	J
12.0	J
15.0	J
22.0	J
27.0	J
33.0	J
39.0	J
47.0	J
56.0	J
68.0	J
82.0	J
100.0	J
470.0	J
1000.0	J

300 Capacitors 10 each of 30 values.
All chips are laser marked.

*Tolerance: B = ± 0.1 pF, C = ± 0.25 pF, J = $\pm 5\%$.

Kit 2001 UZ	
Capacitor Value pF	Tolerance*
1.0	B
1.5	B
1.8	B
2.0	B
2.2	B
2.4	C
2.7	C
3.0	C
3.3	C
3.6	C
3.9	C
4.3	C
4.7	C
5.1	C
5.6	C
6.2	C
6.8	J
8.2	J
10.0	J
12.0	J
15.0	J
22.0	J
27.0	J
33.0	J
39.0	J
47.0	J
56.0	J
68.0	J
82.0	J
100.0	J
120.0	J
150.0	J
180.0	J
220.0	J
240.0	J
270.0	K
330.0	K
390.0	K
470.0	K
560.0	K
680.0	K
820.0	K
1000.0	K
2700.0	K
5100.0	K

450 Capacitors 10 each of 45 values.
All chips are laser marked.

*Tolerance: B = ± 0.1 pF, C = ± 0.25 pF, J = $\pm 5\%$, K = $\pm 10\%$

NOTE: Order by Kit Number
Example: Kit 1000 UZ

“U” SERIES KITS

Solder Plated, Nickel Barrier

0402

Kit 5000 UZ*			
Cap. Value pF	Tol. †	Cap. Value pF	Tol. †
0.5	B	4.7	B
1.0	B	5.6	B
1.5	B	6.8	B
1.8	B	8.2	B
2.2	B	10.0	J
2.4	B	12.0	J
3.0	B	15.0	J
3.6	B		

* 150 Capacitors 10 each of 15 values.

0603

Kit 4000 UZ**			
Cap. Value pF	Tol. †	Cap. Value pF	Tol. †
1.0	±.25pF	6.8	±.25pF
1.2	±.25pF	7.5	±.25pF
1.5	±.25pF	8.2	±.25pF
1.8	±.25pF	10.0	±5%
2.0	±.25pF	12.0	±5%
2.4	±.25pF	15.0	±5%
2.7	±.25pF	18.0	±5%
3.0	±.25pF	22.0	±5%
3.3	±.25pF	27.0	±5%
3.9	±.25pF	33.0	±5%
4.7	±.25pF	39.0	±5%
5.6	±.25pF	47.0	±5%

** 240 Capacitors 10 each of 24 values.

0805

Kit 3000 UZ***					
Cap. Value pF	Tol. †	Cap. Value pF	Tol. †	Cap. Value pF	Tol. †
1.0	C	7.5	C	33	J
1.5	C	8.2	C	36	J
2.2	C	9.1	C	39	J
2.4	C	10.0	J	47	J
2.7	C	12.0	J	56	J
3.0	C	15.0	J	68	J
3.3	C	18.0	J	82	J
3.9	C	22.0	J	100	J
4.7	C	24.0	J	130	J
5.6	C	27.0	J	160	J

*** 300 Capacitors 10 each of 30 values.

1210

Kit 3500 UZ***					
Cap. Value pF	Tol. †	Cap. Value pF	Tol. †	Cap. Value pF	Tol. †
2.2	C	18	J	68	J
2.7	C	20	J	82	J
4.7	C	24	J	100	J
5.1	C	27	J	120	J
6.8	C	30	J	130	J
8.2	C	36	J	240	J
9.1	C	39	J	300	J
10	J	47	J	390	J
13	J	51	J	470	J
15	J	56	J	680	J

†Tolerance – B = ±0.1pF
 C = ±0.25pF
 J = ±5%



Introduction to Microwave Capacitors

Introduction to Microwave Capacitors

Microwave Capacitors in MICs

Typical Microwave Circuit Applications

Microwave MLC, SLC, or Thin-Film capacitor applications in MIC circuits can be grouped into the following categories:

- DC Block (in series with an MIC transmission line)
- RF Bypass (in shunt with transmission lines)
- Source Bypass (in shunt with active device)
- Impedance Matching

This chapter discusses these applications and the performance parameters of microwave capacitors affecting these applications.

DC Block

In the DC block application, the chip capacitor is placed in series with the transmission line to prevent the DC voltage from one circuit from affecting another circuit.

The capacitance is chosen so that the reactance is only a fraction of an ohm at the lowest microwave frequency of interest.

The largest value capacitor is used as long as the self-resonant frequency is still much higher than the highest frequency of interest.

RF Bypass

The RF bypass application is used to effectively short out the RF to ground. The capacitor value is also picked to be as large as possible without approaching the self-resonance of the capacitor.

Source Bypass

The source bypass application is the same as the RF bypass except the capacitor is used in conjunction with an active device.

In this application the chip capacitor is butted up to the source of the microwave FET device mounted on the MIC circuit. This is done to minimize the length of the wire bond from the source of the FET to the capacitor. The shorter the wire bond, the lower the corresponding inductance.

The top side of the capacitor should be completely metalized so that the bond wire from the FET to the edge of the capacitor is minimized.

The height of the capacitor must be less than or equal to the height of the FET, usually about 0.005 inches. If the capacitor is higher than the FET, the capacitor will interfere with the bonding tool when wire bonding to the FET.

Impedance Matching

The impedance matching application is to use the chip capacitor to provide the required reactance at a specific point in the circuit.

This is usually the most critical application in terms of the capacitor maintaining a tight tolerance over temperature and from unit-to-unit.

The other applications only require that the capacitance for the DC block and RF bypass maintains a low reactance and the tolerance can be as much as $\pm 50\%$. Whereas the impedance matching function often requires $\pm 1\%$ tolerance.

In general, microwave capacitors should have the following properties:

- Low-loss
- Operate very much below the self-resonant frequency
- The power handling capability should be commensurate with the expected power performance of the circuit
- Capable of wire bonding and gap welding
- Low variation of capacitance over temperature
- Low unit-to-unit variations in capacitance
- Low dimensional variations from unit-to-unit

Typical SLC applications in MIC circuits are shown in:

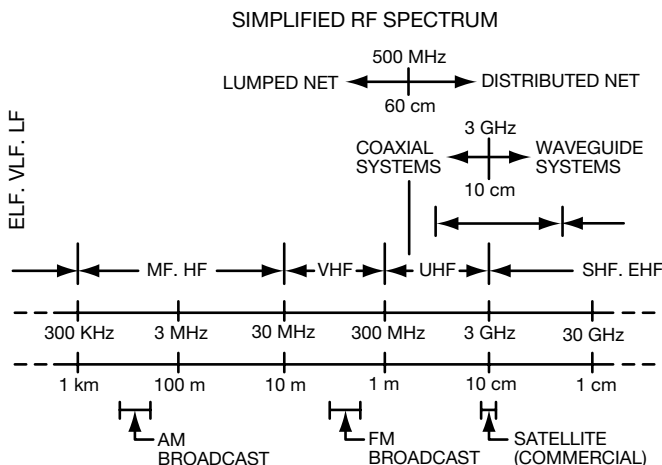

Figure 1

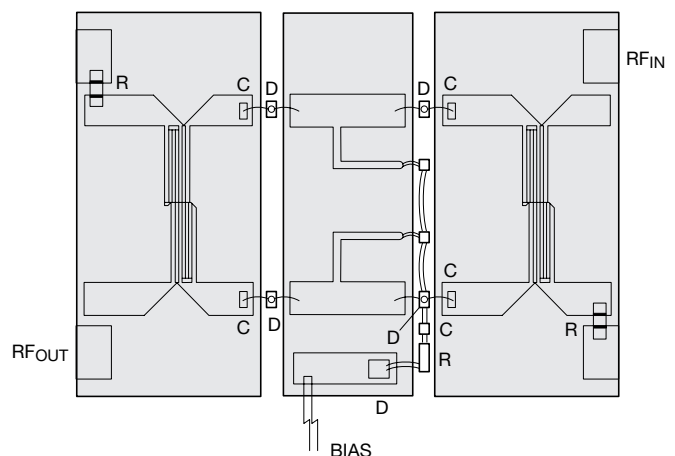

Figure 2. Typical MIC Microwave Attenuator Hybrid with SLC's. "C" indicates SLC locations.

Introduction to Microwave Capacitors

Microwave Parameters

Scattering Parameters

Generally, transmission and reflections coefficient measurements completely characterize any black box or network. Transmission and reflections parameters — attenuation (gain), phase shift, and complex impedance — can be described in terms of a set of linear parameters called “scattering” or “s” parameters. Knowing these characteristic parameters, one can predict the response of cascaded or parallel networks accurately. Unlike y or h parameters which require short circuit and open circuit terminations, “s” parameters are determined with the input and output ports terminated in the characteristic impedance of the transmission line which is a much more practical condition to obtain at RF and microwave frequencies.

To summarize, “s” parameters are more useful at microwave frequencies because:

1. Equipment to measure total voltage and total currents at the ports of the networks is not readily available.
2. Short and open circuits are difficult to achieve over a broad band of frequencies because of lead inductance and capacitance. Furthermore, these measurements typically require tuning stubs separately adjusted at each frequency to reflect short and open circuits to the device terminals, and this makes the process inconvenient and tedious.
3. Active devices such as transistors and negative resistance diodes are very often not short- or open-circuit stable.

There are four scattering parameters for a two-port network: S11, S12, S21, and S22.

S11 is the reflection coefficient at the input port with the output port terminated in a 50 ohm load.

S12 is the reverse transmission coefficient in a 50 ohm system.

S21 is the forward transmission coefficient in a 50 ohm system.

S22 is the reflection coefficient at the output port with the input port terminated into a 50 ohm load.

The reflection coefficients can be directly related to the impedance of the device by the equation:

Eq.1. $Z_{IN}/Z_0 = (1 + S_{11})/(1 - S_{11})$
 where Z_{IN} = input impedance
 Z_0 = characteristic impedance of the transmission line

This equation also defines the Smith Chart.

Return Loss

Return loss is the ratio of the incident power to the reflected power at a point on the transmission line and is expressed in decibels. The reflected power from a discontinuity is expressed as a certain number of decibels below the incident power upon the discontinuity. It can be shown that

return loss can be related to the reflection coefficient and VSWR:

Eq. 2. $RL \text{ (dB)} = 10 * \log (P_{inc}/P_{ref})$
 $= 20 * \log (E_{inc}/E_{ref}) = 20 * \log (1/Rho)$

Eq. 3. $Rho = (VSWR - 1)/(VSWR + 1)$

Eq. 4. $VSWR = (1 + Rho)/(1 - Rho)$

- where Rho = reflection coefficient
- RL = return loss
- Pinc = power incident
- Pref = power reflected
- Einc = voltage incident
- Eref = voltage reflected
- VSWR = voltage standing wave ratio

By the above equation, when the reflection coefficient is 1, the return loss is zero. In this case, no signal is lost and all the signal incident upon the discontinuity was returned to the source. As the reflection coefficient approaches zero, the return loss approaches infinity. That is, the more perfect the load, the less the reflection from that load.

The return loss can be improved by an attenuator.

Assume that we connect a perfectly matched 3 dB attenuator into a short circuit as shown in Figure 3.

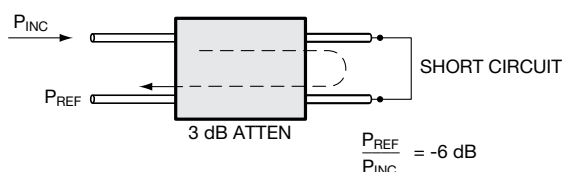

Figure 3

The indicated 100 mw is decreased to 50 mw at the output of the 3 dB attenuator. This 50 mw is reflected from the short circuit back through the attenuator in the reverse direction and one-half of this reflected power is lost in the 3 dB attenuator. The reflected power at the input is 25 mw. Notice the return loss is equal to twice the attenuation because it is the “round trip” loss. This example shows that VSWR is decreased when attenuation exists on a transmission line and also that a high VSWR can be decreased by placing an attenuator in the line.

Mismatch Loss

Mismatch loss is a measure of power loss caused by reflection. It is the ratio of incident power to the difference between incident and reflected power and is expressed in dBs as follows:

Eq. 5. $Mismatch \text{ loss (dB)} = 10 * \log [P_{inc}/(P_{inc} - P_{ref})]$
 $= 10 * \log [1/(1-Rho = 2)]$

Introduction to Microwave Capacitors

Microwave Parameters

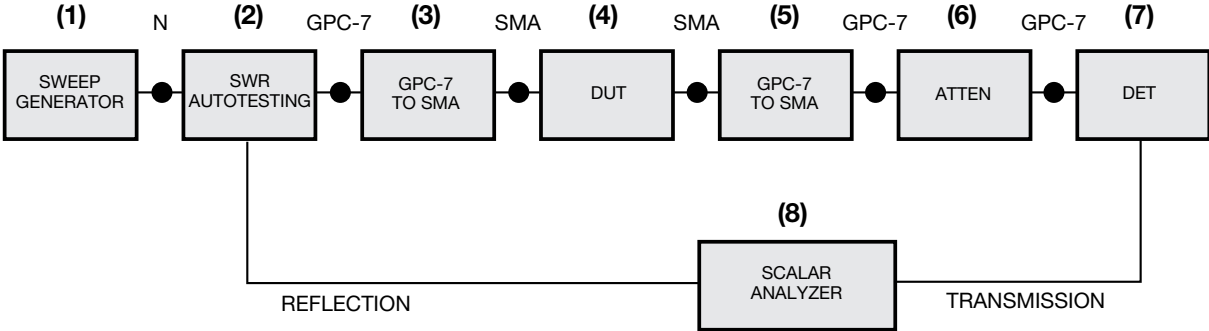

- (1) Wiltron 6647A 10MHz - 18GHz sweepers
- (2) Wiltron 560-97-A50
- (3) OSM 2082-2700-00
- (4) Device under test
- (5) OSM 2082-2700-00
- (6) OSM 7082-6193-10
- (7) Wiltron 560-7A50

Test set-up for:
 (1) Insertion loss
 (2) VSWR

Figure 4

The mismatch loss for various values of VSWR is tabulated as follows:

Table I

VSWR	Mismatch Loss
1.00	0.00 dB
1.20	0.04 dB
1.40	0.12 dB
1.50	0.18 dB
1.70	0.30 dB
2.00	0.51 dB
2.50	0.88 dB
3.00	1.25 dB

Insertion Loss Measurement

Insertion loss is measured by the substitution method. The insertion loss of the measurement system is used as a reference. Then the DUT (Device Under Test) is inserted into the setup and the new insertion loss is measured. The difference between the two losses is the insertion loss of the DUT.

The insertion loss is measured using the test setup as shown in Figure 5.

In order to accurately measure the insertion loss, source VSWR and load VSWR must be extremely low. It is assumed during calibration (loss of the measurement system with the DUT removed from the test setup) that the VSWR of the generator and the load does not contribute any mismatch losses. As discussed in the section on mismatch loss, any VSWR above 1.2:1 may cause a minimum error of 0.04 dB. In addition, the two VSWRs may be additive or subtractive depending on the phasing of the reflections. For example, source and load VSWRs of 1.2:1 can add to create an error of 0.08 dB. The mismatches usually exhibit themselves as amplitude ripple as a function of frequency. It is important when measuring low insertion losses that precautions are taken to ensure low source and load VSWRs and to keep the

mismatch losses due to the two VSWRs to a small fraction of the expected insertion loss of the DUT.

In using the scalar network analyzer it is a temptation to normalize the amplitude response regardless what the actual response is during calibration. It is advisable to eliminate the amplitude ripple first before normalizing the scalar analyzer. One way is to make use of the fact that VSWRs can be improved by the use of matched attenuators. Often, 10 dB attenuators are placed before and after the DUT to provide a minimum of 20 dB return loss which corresponds to source and load VSWRs of less than 1.20:1. This will reduce the uncertainties due to mismatch losses to less than 0.02 dB.

Return Loss Measurement

The return loss is measured by the following method: The test port is terminated by a short circuit so that all the incident power is reflected. A detector on the bridge measures this power and this power is used as the reference for the incident power. The test port is then terminated by the DUT and the reflected power now measured. The difference between the power levels is the return loss.

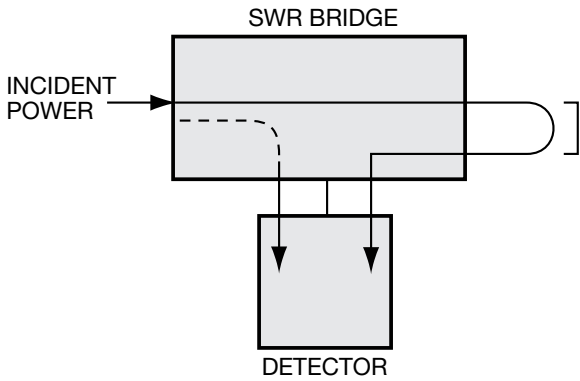
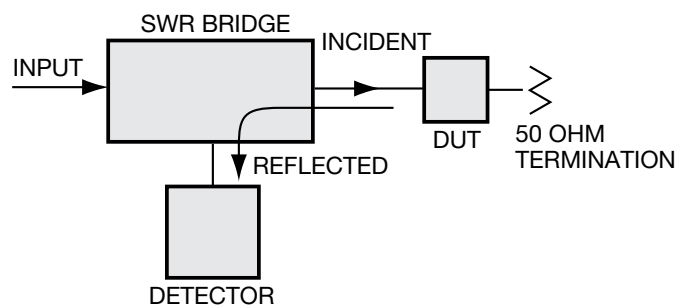

Figure 5. Return Loss Measurement: Establishing a Reference

Introduction to Microwave Capacitors

Microwave Parameters



DUT IN PLACE

Figure 6

- All incident power is reflected at the short circuit.
- The detector measures the reflected power.
- An SWR bridge usually has a directivity of 35 to 40 dB. In other words, only a minute fraction of the incident power reaches the detector (the dotted line path) that is not reflected off the short circuit.
- The DUT is substituted for the short circuit and the opposite port is terminated by a matched termination (50 ohms).
- The reflected power depends on the DUT and is sensed by the detector.
- The return loss is the difference between this reflected power and that measured with a reference short circuit.
- A significant improvement in calibrating a 0 dB return loss reference by averaging the short circuit and open circuit reflected powers.
- The dotted line in the figure below shows the reflections due to an open circuit.
- The solid line in the figure below shows the reflections due to a short circuit.
- Since the phase difference between short circuit and open circuit is 180 degrees.
- By taking the average between these two voltages, the actual full reflection is very closely approximated.

AVERAGING THE SHORT CIRCUIT AND OPEN CIRCUIT REFERENCES FOR HIGHER ACCURACY

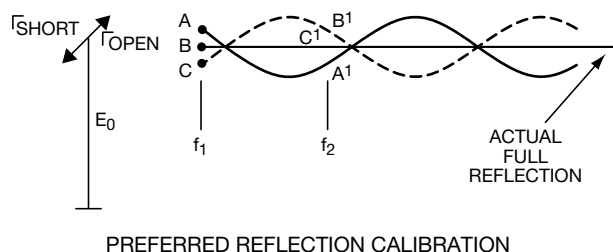

Figure 7

Note that the insertion loss and return loss can be measured simultaneously by using the dual trace feature of the Wiltron Scalar Analyzer. Furthermore, the two measurements can be done by using a controller such as the HP85 computer for semi-automatic testing.

The calibration for 0 dB return loss can be improved by averaging the short circuit and open circuit reflected powers. Since the phase difference is 180 degrees, the average closely approximates the actual full reflection.

Decibels

The decibel, abbreviated “dB,” is one-tenth of the international transmission unit known as the “bel.” The origin of the bel is the logarithm to the base 10 of the power ratio. It is the power to which the number 10 must be raised in order to equal the given number. The number 10 is raised to the second power, or squared, in order to get 100. Therefore, the log of 100 is 2.

The decibel is expressed mathematically by the equation:

Eq. 6 $dB = 10 * \log (P_2/P_1)$
 $P_2 =$ larger power
 $P_1 =$ lower power

The use of log tables can be avoided in practical applications where exact values of the power are not required. One only needs to know that a factor of 2 is equal to 3 dB and a factor of 10 is equal to 10 dB and the rest of the conversions are derived from these two relationships. The use of dBs reduces multiplication into an addition. For example:

3dB =	2
6dB = 2 x 2 =	4
9dB = 2 x 2 x 2 =	8
10dB =	10
20dB =	100

The technique is based on the fact that 3, 6, and/or 9 dB can be added or subtracted (in some combination) to any decibel value. Adding or subtracting 10 to a decibel value simply multiplies or divides the number by ten. Examples:

1. 17dB = 20dB - 3dB
 20dB is 10dB + 10dB or is equal to 100.
 3dB is equal to 2

Therefore, 20 dB - 3dB = 100/2 = 50

2. 36dB = 30dB + 6dB
 1000 x 4 = 4000

Decibel:

The decibel is not a unit of power but merely is a logarithmic expression of a ratio of two numbers. The unit of power may be expressed in terms of dBm, where “m” is the unit, meaning above or below one milliwatt. Since one mw is neither above nor below 1 mw, 1 mw= 0 dBm.

Nepers:

An alternate unit called the neper is defined in terms of the logarithm to the base “e.” e = 2.718.

1 neper = 8.686dB

1dB = 0.1151 neper

Introduction to Microwave Capacitors

Electrical Model

Capacitance

Microwave chip capacitors, although closely approximating an ideal capacitor, nonetheless also contain parasitic elements that are important at microwave frequencies. The equivalent circuit is shown below:

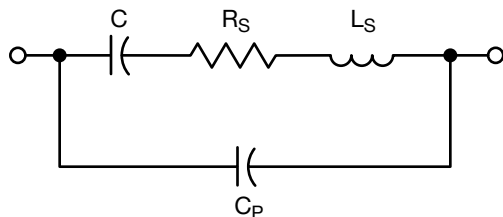

Figure 8. Equivalent Circuit of a Microwave Capacitor

where, C = desired capacitance
 L_s = parasitic series inductance
 R_s = series resistance
 C_p = parasitic parallel capacitance,

R_p , the parallel resistance is not shown as it is of concern only at dc and low frequencies.

The primary capacitance, C , is typically determined by measurement at 1 MHz where the effects of R_s , L_s , and C_p become negligible compared to the reactance of C . The value of C determined at this low frequency is also valid at microwave frequencies when the dielectric constant has a very low variation versus frequency, as is typical in the modern dielectrics employed in microwave capacitors.

The equivalent impedance of the capacitor at any frequency is:

$$\text{Eq. 7. } Z_s = \frac{1}{sC_p + \frac{1}{R_s + sL_s + \frac{1/s}{C_s}}}$$

where $s = j2\pi f$, f = frequency

Series and Parallel Resonance

Ideally, the impedance magnitude of a series mounted capacitor will vary monotonically from infinite at dc to zero at infinite frequency. However, the parasitics associated with any capacitor result in a nonideal response.

Figure 9 shows the magnitude, $|Z(f)|$, as a function of frequency.

Figure 10 shows $Z(f)$ on the Smith Chart, which includes magnitude and phase.

Eq. 8. In general, an impedance is represented by $Z=R + jX$. The Smith Chart maps the entire impedance half plane for $R > 0$ into the interior of a unit circle. The Smith Chart is a mapping of the reflection coefficient, S_{11} , of an impedance. $S_{11} = (Z - Z_0) / (Z + Z_0)$. Z_0 is a reference impedance, typically 50 ohms, and is in the center of the chart. The central horizontal axis is for $X = 0$, with $R < 50$ to the left of center, and $R > 50$ to the right of center.

Figures 9 and 10 also show the point of series resonance (LS in series with C), and parallel resonance (LS in parallel with CP).

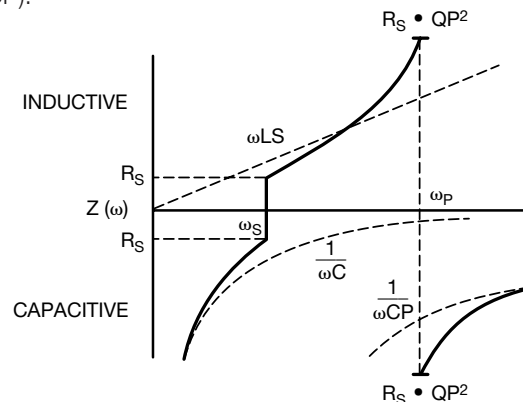

Figure 9. SLC Impedance Magnitude vs. Frequency

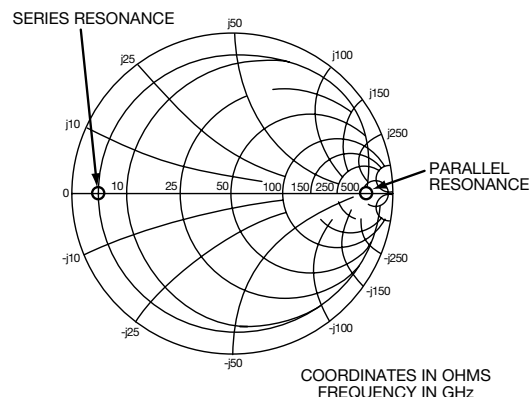

Figure 10. SLC Impedance on Smith Chart

Because there is always some parasitic inductance associated with capacitors, there will be a frequency at which the inductive reactance will equal that of the capacitor. This is known as the series resonant frequency (SRF). At the SRF, the capacitor will appear as a small resistor (R_s). The transmission loss through a series mounted capacitor at its series resonant frequency will be low.

At frequencies above the SRF, the capacitor begins to act like an inductor.

When used as a DC block, the capacitor will begin to exhibit gradually higher insertion loss above the SRF. In other words, the capacitor will cause a high frequency rolloff of its transmission amplitude response.

When used as an RF bypass, as for the source of an FET, the inductance will cause the FET to become unstable which can cause oscillations or undesirable effects on the gain response of the FET amplifier.

Beyond the SRF, there is a frequency called the parallel resonant frequency (PRF). This occurs when the reactance of the series inductor equals that of the parallel capacitor.

Introduction to Microwave Capacitors

Electrical Model

At this parallel resonant frequency, the capacitor will appear as a large resistor whose value is RPRF defined as:

Eq. 9. $R_{PRF} = R_s \times Q_p \times Q_p$; where, $Q_p = \frac{1}{R_s} \frac{W_p}{C_p}$
 $W_p = 2\pi f_{PRF}$

The parasitic parallel capacitance is usually very small which results in a parallel resonant frequency that is much higher than the series resonance.

For capacitor usage in RF impedance matching and tuning applications, the maximum practical frequency for use is up to 0.5 times the SRF.

For DC filtering and RF shunting applications, best performance is obtained near the SRF.

At frequencies above the SRF, but below the PRF, the SLC can be used as a low loss inductor with a built-in DC block for bypassing and decoupling.

The series resonant frequency (SRF) of an SLC can be measured by mounting the capacitor in series on a 50 ohm transmission line as shown in Figure 11.

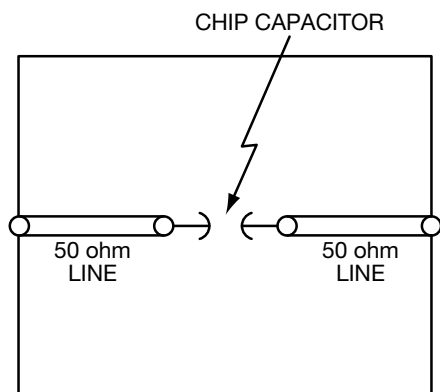

Figure 11

At its series resonant frequency (SRF), the SLC will appear as a small resistance. This measurement can be performed with a vector network analyzer such as the Hewlett Packard 8510. The SRF is at the frequency for which the phase of the input reflection coefficient, S11, is crossing the real axis on the Smith Chart at 180 degrees.

The resonant frequency will be lowered by the inductance associated with the bonding attachment to the capacitor (i.e., bonding wires, ribbons, leads, etc.). The actual resonant frequency of the capacitor by itself can be determined by taking out the effects of the bonding attachment inductance. Using the low frequency measurements of the primary capacitance alone, the inductance of the capacitor can be derived from the resonant frequency. With AVX SLC's, the inductance is low enough so that the practical operating frequencies achieved can be beyond 20 GHz.

Equivalent Series Resistance

The equivalent series resistance is the RS in the electrical model. At the SRF, the ESR can be readily determined on the Smith Chart display of the capacitor's impedance. However, the ESR is not necessarily constant with frequency and its value is typically determined by an insertion loss measurement of the capacitor at the desired frequency.

The insertion loss is a combination of reflective and absorptive components. The absorptive component is the part associated with the value of the ESR (i.e., the loss in RS). Because of the low values of ESR in microwave capacitors (on the order of 0.01 ohm), the insertion loss measurement is very difficult to make, but can be made with a test fixture similar to that shown in Figure 11, but with the input and output 50 ohm impedances transformed down to some more convenient impedance level, Rref, to obtain a more accurate measurement.

When used as a DC block in the transmission line test fixture, the forward transmission coefficient, S21, and the input reflection coefficient, S11, can be measured to determine:

Eq. 10. Dissipative Loss.
 $DL = (1 - |S_{11}|^2) / |S_{21}|^2$

Eq. 11. Reflection Loss.
 $RL = (1 - |S_{11}|^2)$ where S11 and S21 are expressed as complex phasors.

From the dissipative loss, DL, the ESR can be determined as:

Eq. 12. $ESR = R_{ref} * [1 - \sqrt{DL}] / [1 + \sqrt{DL}]$

The ESR typically increases with operating temperature and self-heating under high power. This increase can be seen directly in the lab by measuring the insertion loss of the capacitor as a function of temperature.

A low ESR is especially necessary in SLC's when used in series with transistors in low noise amplifiers, high gain amplifiers, or high power amplifiers. For example, an ESR of 1 ohm in series with a base input impedance of 1 ohm would result in a serious compromise in amplifier gain and noise figure by up to 3 dB.

Power Rating

The RF power rating of chip capacitors is dependent on:

- Thermal Breakdown
- Voltage Breakdown

Thermal Breakdown

Thermal breakdown is self-heating caused by RF power dissipated in the capacitor.

If the resultant heat generated is greater than what can be conducted away through the leads or other means of heat sinking, the capacitor temperature will rise.

Introduction to Microwave Capacitors

Electrical Model

As the capacitor temperature increases, the dissipation factor and ESR of the capacitor also increase which creates a thermal runaway situation.

The small signal insertion loss is used to determine the percentage of power which is dissipated in the capacitor.

For instance, if the insertion loss is:

- 0.01 dB then .2% of the incident power is lost as heat
- 0.10 dB then 2% of the incident power is lost as heat
- 1.00 dB then 20% of the incident power is lost as heat

The capacitor will heat up according to the amount of power dissipated in the capacitor and the heat sinking provided.

Even very low ESR, 0.01 ohm at 1 GHz, can be significant when passing power through a series mounted capacitor into a typically low impedance bipolar transistor base input with an input impedance of only 1 ohm. If 1% of 10 watts is dissipated in the capacitor, this 100 milliwatt of power causes a very large increase in the capacitor temperature dependent on its heat sinking in the MIC circuit.

Voltage Breakdown

The voltage breakdown also limits the maximum power handling capability of the capacitor.

The voltage breakdown properties of the capacitors is dependent on the following:

- dielectric material
- voids in the material
- form factor
- separation of the electrodes

Most microwave capacitors have a DC voltage rating of 50 VDC. This is much greater than typical DC voltages of 3 to 15 volts present on an MIC circuit.

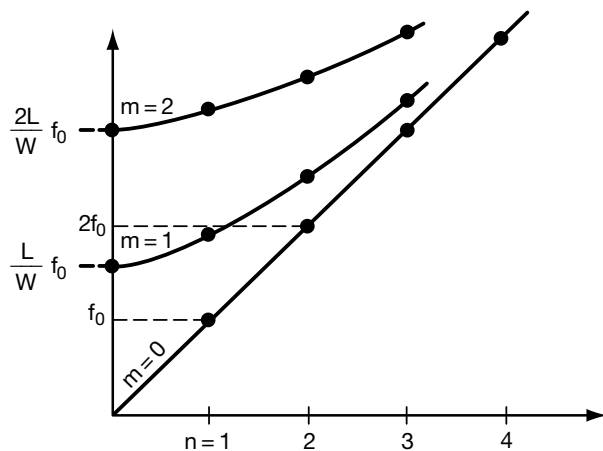

Figure 12

Dispersion Curve of a Rectangular Resonator

Dielectric Constant Measurement at Microwave Frequencies

The measurement of dielectric constants at low frequencies is easily done by measuring the capacitance of a substrate of known dimensions and calculating the dielectric constant.

The resonance method is used in measuring dielectric constants at microwave frequencies of metallized ceramic substrates. This is based on the model of the high dielectric constant substrate as a parallel plate dielectrically loaded waveguide resonator. By observing the resonant frequencies and knowing the dimensions of the substrate, the dielectric constant is calculated by fitting the resonances into a table of expected fundamental and higher order modes. This method can be measured by connecting the corners of the substrates to the center conductors of either an APC-7 or Type N connector. The test setup is the same as for insertion loss measurements. This method as described in the literature for an alumina substrate with a dielectric constant of approximately 10 and a substrate height of 0.025 inches can be measured to an accuracy of 2%. The Napoli-Hughes Method uses an open circuit assumption for the unmetallized edges which can be radiative. This inaccuracy is reduced if thinner substrates or if higher dielectric constant substrates are used which will tend to reduce radiation. Higher accuracy can be achieved by metallizing all six sides of the substrate except for the corners where the RF is coupled to the substrate. This method as reported by Howell provided more consistent results.

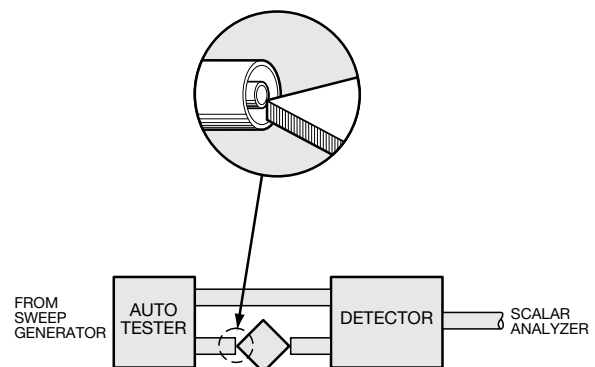

Figure 13

Test Configuration for Resonance Measurements

Introduction to Microwave Capacitors Transmission Lines



Propagation Constant and Characteristic Impedance

The incident waves of voltage and current decrease in magnitude and vary in phase as one goes toward the receiving end of the transmission line which has losses. The propagation constant is a measure of the phase shift and attenuation along the line.

- attenuation per unit length of line is called the attenuation constant. (dB or nepers per unit length)
- phase constant, phase shift per unit length. (radians per unit length)
- angular frequency, $2 * \pi * f$

$(R+j\omega L)$ - complex series impedance per unit length of line.

$(G+j\omega C)$ - complex shunt admittance per unit length of line.

Eq. 13. $Z_0 \rightarrow$ for lossless case: $Z_0 = \sqrt{L/C}$

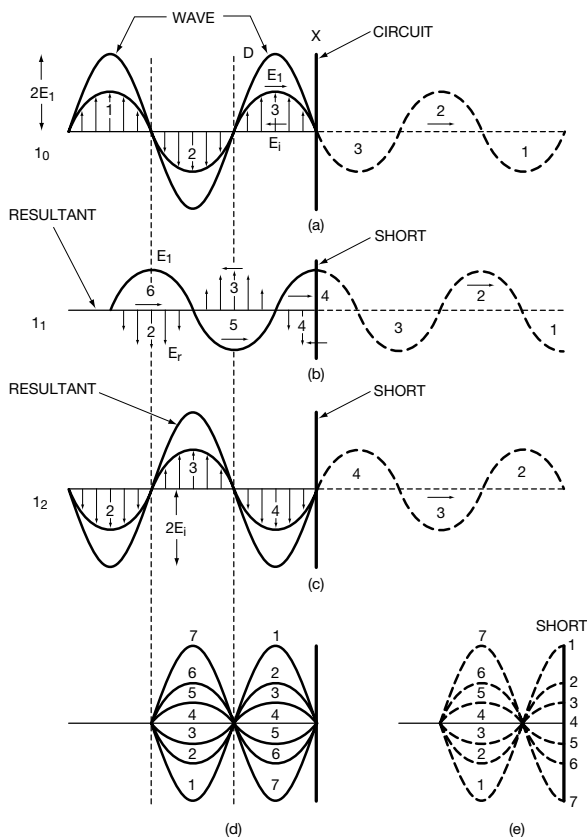

Figure 14

This figure shows generation of standing waves on a shorted transmission line. Dotted lines to the right of the short circuit represent the distance the wave would have traveled in absence of the short. Dotted vectors represent the reflected wave. The heavy solid line represents the vector sum of the incident and reflected waves. (d) and (e) represent instantaneous voltages and currents at different intervals of time.

Standing Waves

Standing waves on the lossless transmission line:

An incident wave will not be reflected if the transmission line is terminated in either matched load or if the transmission line is infinitely long. Otherwise, reflected waves will be present. In other words, any impedance will cause reflections.

Let us consider the case of a lossless transmission line terminated in a short line. In this case all of the incident wave will be reflected. See Figure 15.

The dotted sine wave to the right of the short circuit in the diagram indicates the position and distance the wave would have traveled in the absence of the short circuit. With the short circuit placed at X, the wave travels the same distance back toward the generator. In order to satisfy the boundary conditions, the voltage at the short circuit must be zero at all times. This is accomplished by a reflected wave which is equal in magnitude and reversed in polarity (shown by the superimposed reflected wave and the resultant total voltage on the line). Note that the total voltage is twice the amplitude of the incident voltage at a quarter wavelength back toward the generator and the total voltage is zero at one-half wavelength from the short.

DISTRIBUTED PARAMETER MODEL OF A SECTION OF TRANSMISSION LINES:

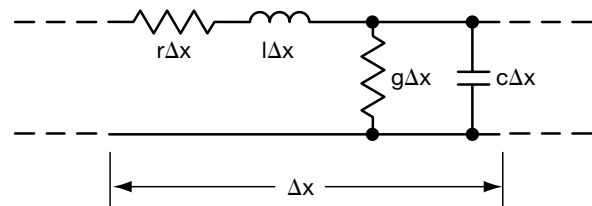

where G = Conductance per unit length
 R = Resistance per unit length
 C = Capacitance per unit length
 L = Inductance per unit length
 ΔX = Incremental length

Figure 15

PURE TRAVELING WAVE

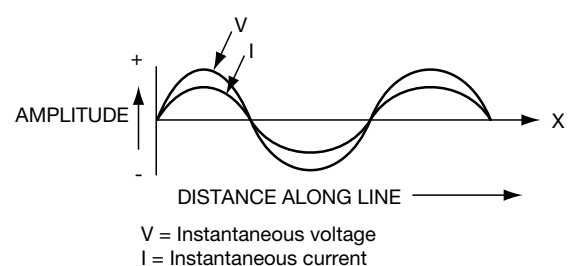

Pure traveling waves: V & I in the lossless case are in phase. V & I also reverse polarity every half wavelength.

Figure 16



Introduction to Microwave Capacitors

Transmission Lines

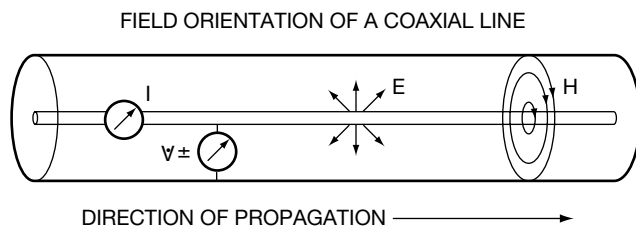

Figure 17

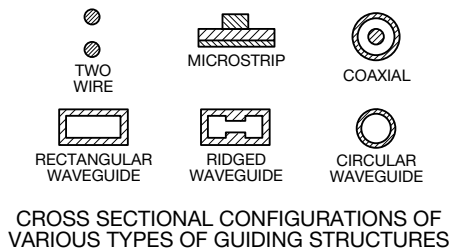

Figure 18

The total voltage pattern is called a standing wave. Standing waves exist as the result of two waves of the same frequency traveling in opposite directions on a transmission line.

The total voltage at any instant has a sine wave distribution along the line with zero voltage at the short and zero points at half wave intervals from the short circuit. The points of zero voltages are called voltage nodes and the points of maximum voltage halfway between these nodes are called antinodes.

Open Circuit:

At a distance of one-quarter wavelength from the short, the voltage is found to be twice the amplitude of the incident voltage, which is equivalent to an open circuit. Therefore, this same distribution would be obtained if an open circuit were placed a quarter wavelength from the short. In the case the first node is located a quarter wavelength from the open and the first antinode is right as the open. The node-to-node spacing remains half wavelength as is the antinode-to-antinode spacing.

Voltage Standing Wave Ratio:

The voltage standing wave ratio is defined as the ratio of the maximum voltage to the minimum voltage on a transmission line. This ratio is most frequently referred to as VSWR (Viswar).

$$\text{Eq. 14. } VSWR = \frac{E_{max}}{E_{min}} = \frac{E_i + E_r}{E_i - E_r} = \frac{1 + \rho}{1 - \rho}$$

where ρ = reflective coefficient

If the transmission line is terminated in a short or open circuit, the reflected voltage, E_r , is equal to the incident voltage, E_i . From the above equation the reflection coefficient is 1.0, and the VSWR is infinite. If a matched termination is connected to the line, the reflected wave is zero, the reflection coefficient is zero, and the VSWR is zero.

Introduction to Microwave Capacitors

Incorporation of Capacitors into Microwave Integrated Circuit Hybrids

Microwave Integrated Circuit Hybrids

A Microwave Integrated Circuit Hybrid (MIC) is a microwave circuit that uses integrated circuit production techniques involving such factors as thin or thick films, substrates, dielectrics, conductors, resistors, and microstrip lines, to build passive assemblies on a dielectric. Active elements such as microwave diodes and transistors are usually added after photo resist, masking, etching, and deposition processes have been completed. MICs usually are enclosed as shielded microstrip to prevent electromagnetic interference with other components or systems. This section will discuss some of the important characteristics of MICs, such as:

- MIC substrates
- MIC metallization
- MIC components

MIC Substrates:

Microstrip employs circuitry that is large compared to the wavelength of the frequency used with the circuit. For this reason, the etched metal patterns often are distributed circuits with transmission lines etched directly onto the MIC substrate. Figure 19 shows the pertinent dimensional parameters for a microstrip transmission line.

For the current discussion we are most interested in the higher microwave frequencies. The MIC circuit design requires a uniform and predictable substrate characteristic. Several types of substrates in common usage are: alumina, sapphire, quartz, and beryllium oxide. Key requirements for a MIC substrate are that it have:

- Low dielectric loss
- Uniform dielectric constant
- Smooth finish
- Low expansion coefficient

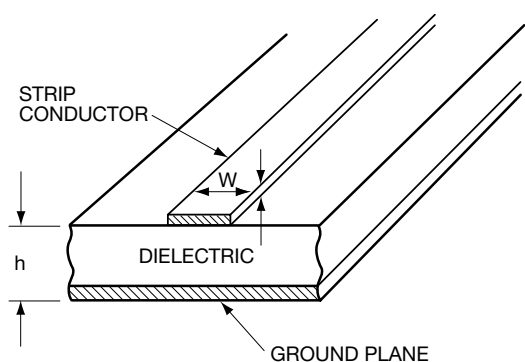

Figure 19. MIC Microstrip Outline

The characteristic impedance of the microstrip line is dependent primarily on the following:

- Width of the conductor: Increase in the width "W" of the conductor will decrease the ZO of the microstrip line.
- Height of the substrate: Increase in the height "H" of the substrate will increase the ZO of the microstrip line.

- Dielectric Constant: Increase of the dielectric constant of the substrate will decrease the ZO of the microstrip line.

Table II shows a brief listing of substrate properties.

Table II

Material	Alumina	Sapphire	Quartz	Beryllium Oxide
Relative Dielectric Constant, E_r	9.8*	11.7	3.8	6.6
Loss Tangent at 10 GHz	0.0001	0.0001	0.0001	0.0001
Thermal Conductivity K, in W/CM/Deg. C	0.3	0.4	0.01	2.5

*Alumina E_r depends on vendor and purity.

The dependence of ZO to the above parameters is as shown:

Eq. 15. $ZO(f) = 377 * H(W)/\text{Sqrt}(E_r)$

- where,
- H = height of the substrate
 - W = width of the microstrip conductor
 - E_r = dielectric constant of the substrate

A graph of ZO versus W/H for several values of dielectric constants is shown below:

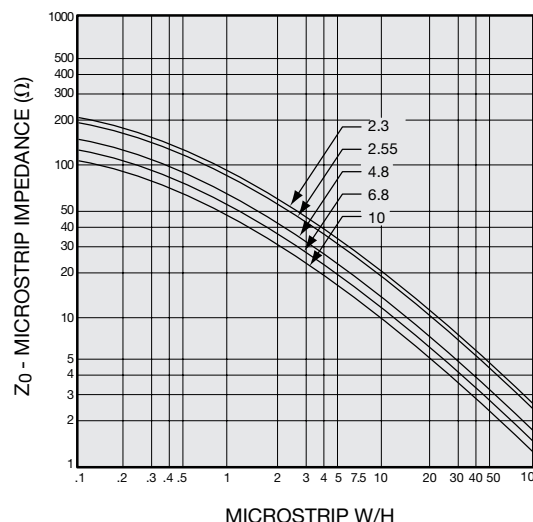

Figure 20

The most popular substrate material is alumina which has a dielectric constant of between 9.6 and 10.0 depending on the vendor and the purity. Other substrates are used where the specified unique properties of the material (beryllia for high power, ferrites for magnetic properties) are demanded by design.

Introduction to Microwave Capacitors

Incorporation of Capacitors into Microwave Integrated Circuit Hybrids

MIC Metallization:

MIC metallization is a thin film of two or more layers of metals. A base metallization layer is deposited onto the substrate, another layer may be optionally deposited on top of this, and then a final gold layer is deposited onto the surface. The base metallization is chosen for its adhesion to the substrate and for compatibility with the next layer.

The base metallization is usually lossy at microwave frequencies. The losses due to this metallization can be kept to a minimum if its thickness does not exceed one "skin depth" of the metal.

Skin effect defines a phenomenon at microwave frequencies where the current travelling along a conductor does not penetrate the conductor but remains on the surface of the conductor. The "skin depth" indicates how far the microwave current will penetrate into the metal. The "skin depth" is smaller as the frequency increases.

By keeping the lossy metallization as thin as possible, more of the microwave current will propagate in the top metallization gold layer and loss is minimized.

Typical metallization schemes used in the industry are:

- Chromium-Gold: Cr-Au
- Nichrome-Gold: NiCr-Au
- Chromium-Copper-Gold: Cr-Cu-Au
- Titanium-Tungsten-Gold: TiW-Au
- Others

MIC Components:

Microstrip has advantages over other microwave circuit topologies in that active semiconductors and passive components can easily be incorporated to make active hybrid circuits. It is possible to mix high and low frequency circuitry to attain a "system-on-a substrate."

Passive Components:

On MIC circuits, the passive components are either distributed or lumped elements. The distributed components are usually realized by etched patterns on the substrate metallization. The lumped components are capacitors, resistors, and inductors; and whenever possible components are derived by etching them directly on the MIC metallization thin film. Chip components are used when they offer advantages such as:

- Component values are beyond that realizable by thin film techniques on the MIC substrates,
- Smaller size is required,
- High power capability is required.

Capacitors, resistors, and inductors are discussed in the following:

Capacitors:

A lumped capacitor can be realized by the parallel gap capacitance of an area of metallization on the top of the substrate to the ground plane. Values of capacitance that can be obtained by this method are usually less than a few picofarads. At microwave frequencies if the capacitor size in any one dimension begins to approach a quarter-wavelength, a resonance will occur.

Large values of capacitance can be achieved with a dielectric constant between the capacitor plates while maintaining the small size required for MIC circuits.

Chip capacitors can be fabricated on substrate with a dielectric constant up to 5000. This higher dielectric constant allows a much smaller size capacitor for a given capacitance value which is a very desirable feature both from the real estate aspect and the self-resonance aspect.

Resistors:

MIC resistors are often realized by using a resistive base layer on the MIC substrate metallization, and by etching the proper pattern to expose the resistive layer in the MIC circuitry.

The exact value of the resistor is determined by:

- resistivity of the resistive base layer, and
- length and width of the resistor.

Thin film resistive base layers are usually the following:

- tantalum nitride, or
- nickel-chrome (nichrome).

When chip resistors are used, they are mounted and connected in the same way as the chip capacitors.

Inductors:

Inductors are often realized by using narrow etched microstrip lines which provides inductance on the order of 1 to 5 nanohenrys.

Higher values up to 50 nanohenrys are obtained by etching a round or square spiral onto the MIC metallization.

Even higher values can be obtained by using wound wire inductors or chip inductors which are wire coils encased in a ceramic.

Both types of discrete inductors are attached to the circuit by the same means as the capacitors.

Introduction to Microwave Capacitors

Incorporation of Capacitors into Microwave Integrated Circuit Hybrids

Active components:

The active devices in the MIC circuit can be made of entirely different materials than the substrates and are usually attached to the substrates by eutectic soldering or conductive epoxy.

Typical active devices on MIC circuits are the following:

- GaAs FETs
- Bipolar Transistors
- Schottky Barrier Diodes
- PIN Diodes
- Various other Semiconductors

The active devices can be either in:

- a plastic or ceramic package with metal leads, or
- chip form.

The packaged devices are commonly used at a lower frequency range than the chip devices since they exhibit more parasitic circuit elements that limit their performance at higher frequency.

The advantages of packaged devices are protection of the devices during transport and mounting, ease of characterization, and ease of mounting onto the MIC circuit.

Chip Component Attach:

The methods of attachment of the chip components to the substrate are usually by:

- eutectic solder die attach, and
- epoxy die attach.

1. Eutectic Die Attach

The eutectic die attach method can be used with several alloys. Eutectic defines the exact alloy combination at which the solidus to liquidus transition takes place at one particular

temperature. Other combinations have transition states with wider temperature ranges. For instance, the eutectic temperature for the following alloys are:

Table III

Alloy	Eutectic Composition	Eutectic Temperature
Gold Germanium	88% Au 12% Ge	356°C
Gold Tin	80% Au 20% Sn	280°C

For best results, the eutectic attach is performed under an inert gas atmosphere, typically nitrogen, to reduce oxidation at high temperatures. The eutectic must be selected so that the die attach operations will not interfere with prior soldering operations and itself will not be disturbed by subsequent process steps. The metallization should be able to undergo 400°C without any blistering or other adhesion degradation.

2. Epoxy Die Attach

The epoxy die attach method uses silver or gold conductive particles in an epoxy. The epoxy for chip attach on MIC circuits is a one-part type which cures at temperatures of from 125°C to 200°C. The curing time is a function of temperature. A cure time of 30 minutes at 150°C is a good compromise for high reliability and a reasonable cure time.

Chip Components Interconnection:

The chip components are interconnected to the MIC circuit by means of:

- wire bonding, and
- miniature parallel gap welding.

PASSIVES

Capacitors

- Multilayer Ceramic
- Tantalum
- Microwave
- Glass
- Film
- Power Film
- Power Ceramic
- Ceramic Disc
- Trimmer
- BestCap™

Resistors

- Arrays

Timing Devices

- Resonators
- Oscillators
- Crystals

Filters

- EMI
- SAW
- Dielectric

Thin Film

- Inductors
- Fuses
- Capacitors
- Couplers
- Baluns
- Filters

Integrated Passive Components

- Low Inductance Chip Arrays
- Capacitor Arrays
- Dual Resonance Chips
- Custom IPCs

Voltage Suppressors, Varistors and Thermistors

Acoustical Piezos

CONNECTORS

- 2mm Hard-Metric for CompactPCI®

- Automotive Connectors

- Board to Board Connectors – SMT and Through-Hole

- Card Edge

- Compression

- Custom Designed Connectors

- Customized Backpanel, Racking and Harnessing Services

- DIN 41612 Connectors

- FFC/FPC Connectors

- Insulation Displacement Connectors

- I/O Connectors

- Memory Card Connectors
CF, PCMCIA, SD, MMC

- MOBO™, I/O, Board to Board and Battery Connectors

- Press-fit Connectors

- Varicon®

- Wire to Board, Crimp or IDC

**For more information please visit
our website at**

<http://www.avx.com>

NOTICE: Specifications are subject to change without notice. Contact your nearest AVX Sales Office for the latest specifications. All statements, information and data given herein are believed to be accurate and reliable, but are presented without guarantee, warranty, or responsibility of any kind, expressed or implied. Statements or suggestions concerning possible use of our products are made without representation or warranty that any such use is free of patent infringement and are not recommendations to infringe any patent. The user should not assume that all safety measures are indicated or that other measures may not be required. Specifications are typical and may not apply to all applications.

© AVX Corporation

USA

AVX Myrtle Beach, SC
Corporate Offices
Tel: 843-448-9411
FAX: 843-448-1943

AVX North Central, IN
Tel: 317-848-7153
FAX: 317-844-9314

AVX Southwest, AZ
Tel: 602-678-0384
FAX: 602-678-0385

AVX Southeast, GA
Tel: 404-608-8151
FAX: 770-972-0766

AVX Northwest, WA
Tel: 360-699-8746
FAX: 360-699-8751

AVX Mid/Pacific, CA
Tel: 510-661-4100
FAX: 510-661-4101

AVX South Central, TX
Tel: 972-669-1223
FAX: 972-669-2090

AVX Canada
Tel: 905-238-3151
FAX: 905-238-0319

EUROPE

AVX Limited, England
European Headquarters
Tel: ++44 (0) 1252-770000
FAX: ++44 (0) 1252-770001

AVX/ELCO, England
Tel: ++44 (0) 1638-675000
FAX: ++44 (0) 1638-675002

AVX S.A., France
Tel: ++33 (1) 69-18-46-00
FAX: ++33 (1) 69-28-73-87

AVX GmbH, Germany
Tel: ++49 (0) 8131-9004-0
FAX: ++49 (0) 8131-9004-44

AVX srl, Italy
Tel: ++390 (0)2 614-571
FAX: ++390 (0)2 614-2576

AVX Czech Republic
Tel: ++420 465-358-111
FAX: ++420 465-323-010

ASIA-PACIFIC

AVX/Kyocera, Singapore
Asia-Pacific Headquarters
Tel: (65) 6286-7555
FAX: (65) 6488-9880

AVX/Kyocera, Hong Kong
Tel: (852) 2-363-3303
FAX: (852) 2-765-8185

AVX/Kyocera, Korea
Tel: (82) 2-785-6504
FAX: (82) 2-784-5411

AVX/Kyocera, Taiwan
Tel: (886) 2-2698-8778
FAX: (886) 2-2698-8777

AVX/Kyocera, Malaysia
Tel: (60) 4-228-1190
FAX: (60) 4-228-1196

Elco, Japan
Tel: 045-943-2906/7
FAX: 045-943-2910

Kyocera, Japan - AVX
Tel: (81) 75-604-3426
FAX: (81) 75-604-3425

Kyocera, Japan - KDP
Tel: (81) 75-604-3424
FAX: (81) 75-604-3425

AVX/Kyocera, Shanghai, China
Tel: 86-21 6886 1000
FAX: 86-21 6886 1010

AVX/Kyocera, Tianjin, China
Tel: 86-22 2576 0098
FAX: 86-22 2576 0096

Contact:

