

■ Package Dimensions :

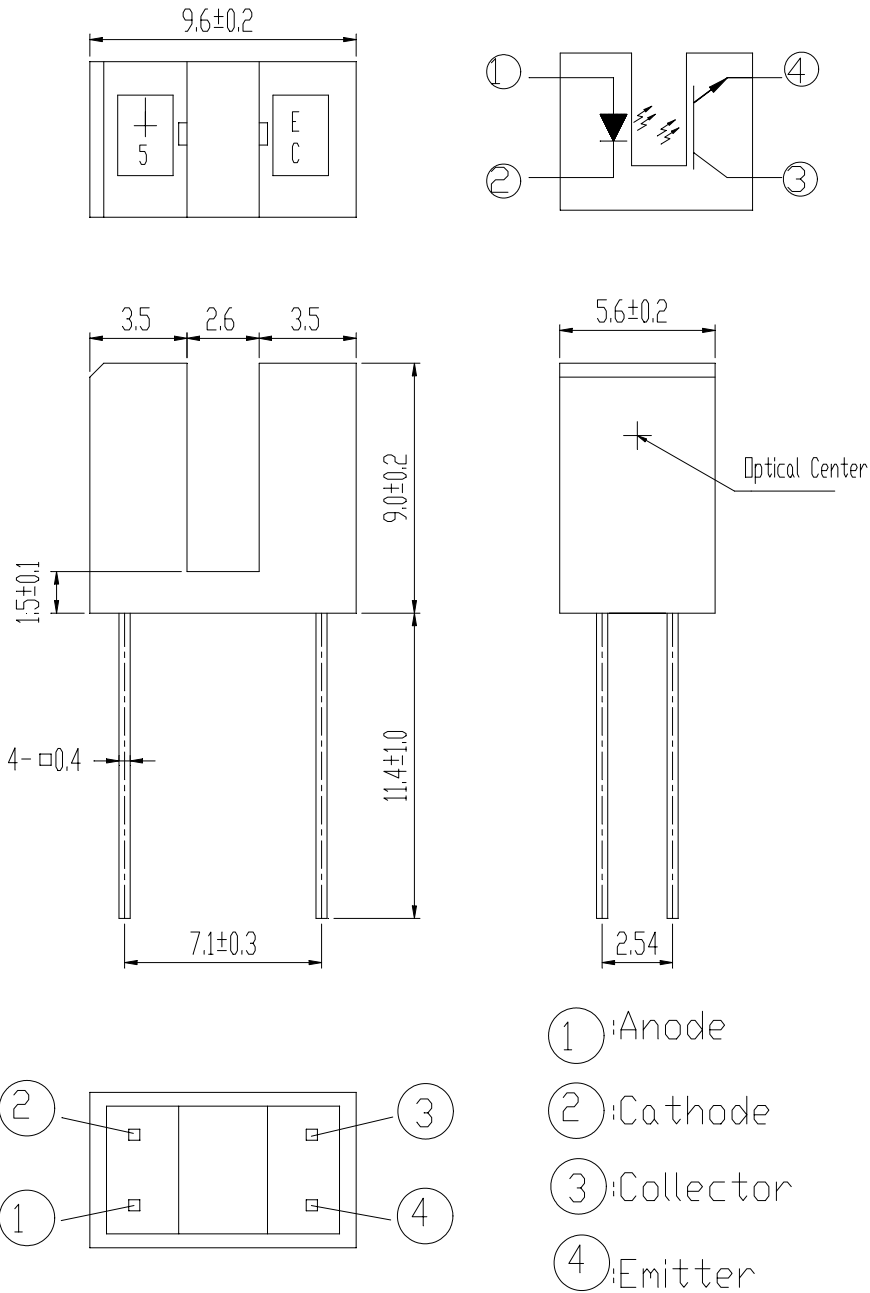

DESIGNER	CHECKER	APPROVED

Office: NO 25, Lane 76, Chung Yang Rd., Sec.3
 Tucheng, Taipei 236, Taiwan, R.O.C.
 TEL: 886-2-2267-2000, 2267-9936 (22Lines)
 FAX: 886-2-2267-6189



◎Notes :

- 1.All dimensions are in millimeter.
- 2.General Tolerance:±0.2mm
- 3.Lead spacing is measured where the lead emerge from the package.
- 4.Above specification may be changed without notice. EVERLIGHT will reserve authority on material change for above specification.
- 5.These specification sheets include materials protected under copyright of EVERLIGHT corporation. Please don't reproduce or cause anyone to reproduce them without EVERLIGHT's consent.
- 6.When using this product , please observe the absolute maximum ratings and the instructions for use outlined in these specification sheets. EVERLIGHT assumes no responsibility for any damage resulting from use of the product which does not comply with the absolute maximum ratings and the instructions included in these specification sheets.

■ Descriptions:

The ITR8105 (Slot Optical Switch) is a gallium arsenide infrared emitting diode which is coupled with a silicon photo transistor in a plastic housing. The packaging system is designed to optimize the mechanical resolution, coupling efficiency, and insulates ambient light. The slot in the housing provides a means of interrupting the signal with printer, scanner, copier, or other opaque material, switching the output from an " ON" to " OFF" state.

■ Features:

- Wide gap between light emitter and detector(2.6mm)
- High sensing accuracy
- PWB mounting type package
- Pb free

■ Applications:

- Copier
- Printer
- Facsimile
- Ticket vending machine
- Opto-electronic switch



Absolute Maximum Ratings (Ta=25°C)

Parameter		Symbol	Ratings	Unit
Input	Power Dissipation at (or below) 25°C Free Air Temperature	Pd	75	mW
	Reverse Voltage	V _R	5	V
	Forward Current	I _F	50	mA
	Peak Forward Current Pulse width ≤100μs, Duty cycle=1%	I _{FP}	1	A
Output	Collector Power Dissipation	P _C	75	mW
	Collector Current	I _C	20	mA
	Collector-Emitter Voltage	V _{CEO}	30	V
	Emitter-Collector Voltage	V _{ECO}	5	V
Operating Temperature		Topr	-25~+85	°C
Storage Temperature		Tstg	-40~+85	°C
Lead Soldering Temperature (1/16 inch from body for 5 seconds)		Tsol	260	°C

Electro-Optical Characteristics (Ta=25°C)

Parameter		Symbol	Min.	Typ.	Max.	Unit	Condition
Input	Forward Voltage	V _F	-	1.2	1.6	V	I _F =20mA
	Reverse Current	I _R	-	-	10	μA	V _R =5V
	Peak Wavelength	λ _p	-	940	-	nm	I _F =20mA
	View Angle	2θ _{1/2}	-	60	-	Deg	I _F =20mA
Output	Collector Dark Current	I _{CEO}	-	-	100	nA	V _{CE} =10V
Transfer Characteristic	C-E Saturation Voltage	V _{CE(sat)}	-	-	0.4	V	I _C =0.5mA I _F =20mA
	Collector Current	I _{C(ON)}	1	4	15	mA	V _{CE} =5V I _F =10mA
	Rise time	t _r	-	20	-	μsec	V _{CE} =5V
	Fall time	t _f	-	20	-	μsec	I _C =1mA R _L =1KΩ

■ Typical Characteristics For IR

Fig. 1 Forward Current vs. Ambient Temperature

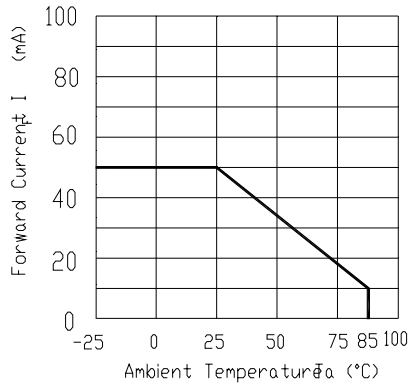

Fig. 2 Spectral Distribution

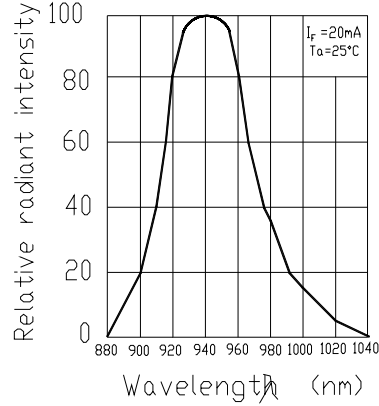

Fig. 3 Peak Emission Wavelength vs. Ambient Temperature

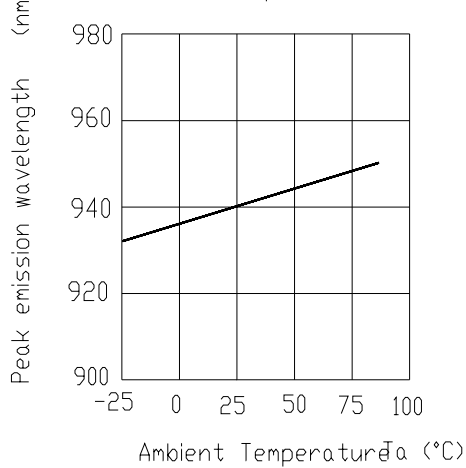

Fig. 4 Forward Current vs. Forward Voltage

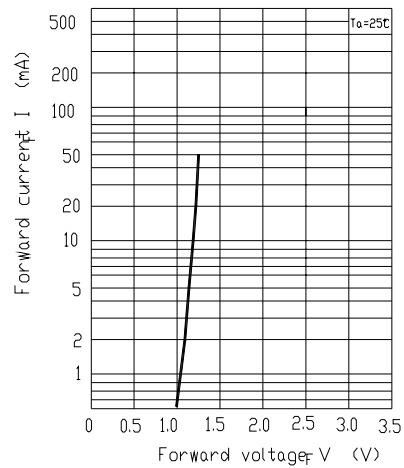

Fig. 5 Forward Voltage vs. Ambient Temperature

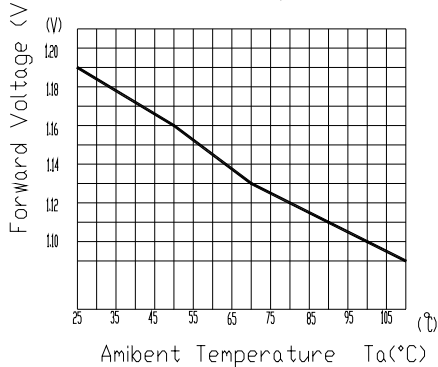
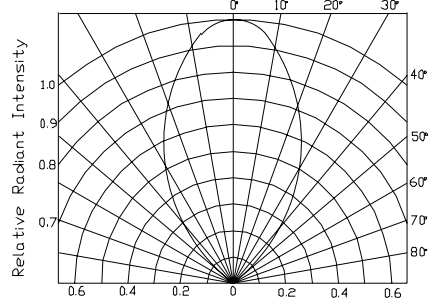

Fig. 6 Relative Radiant Intensity vs. Angular Displacement



■ Typical Characteristics For PT

Fig.1 Collector Power Dissipation vs. Ambient Temperature

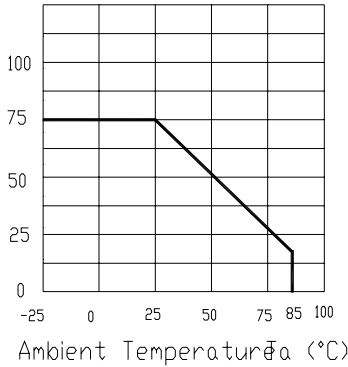

Fig.2 Collector Dark Current vs. Ambient Temperature

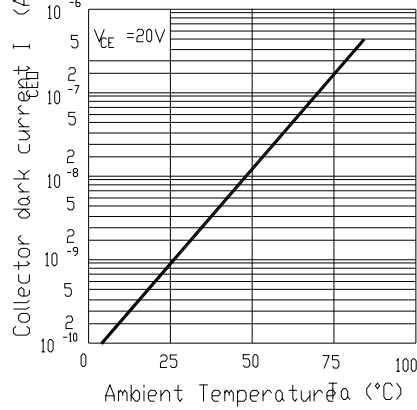

Fig.3 Spectral Sensitivity

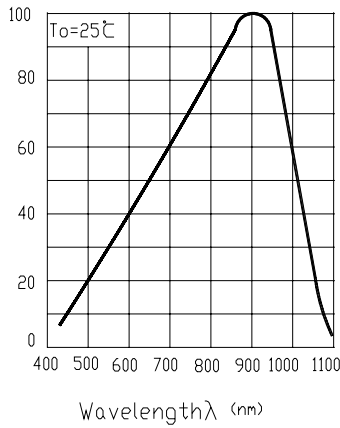
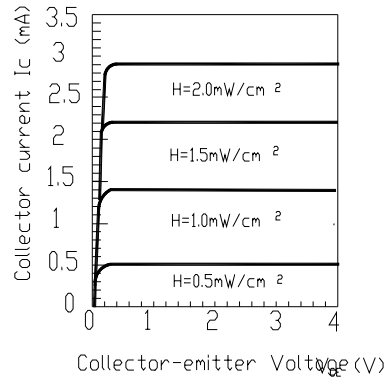

Fig.4 Collector Current vs. Collector-emitter Voltage



■ Typical Characteristics For ITR

Fig.1 Relative Collector Current vs. Shield Distance(1)

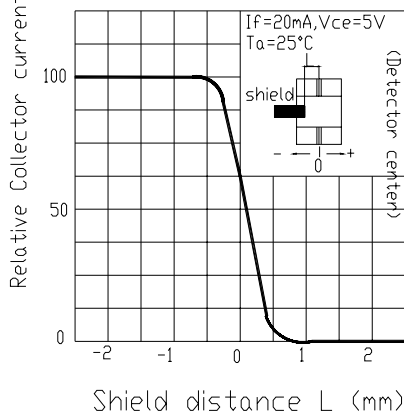
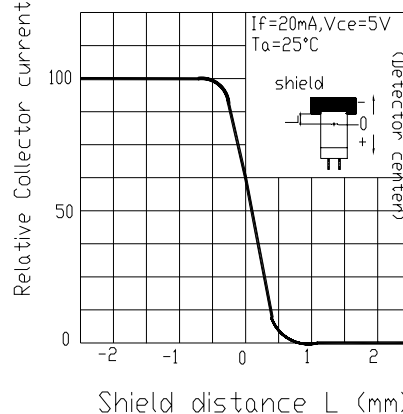

Fig.2 Relative Collector Current vs. Shield Distance(2)





■ Reliability test item and condition

The reliability of products shall be satisfied with item listed below:

Confidence level :90%

LTPD:10%

Parameter	Purpose & Condition	Failure Judgement Criteria	Samples(n) Defective(c)
Temperature Cycle	Evaluates product's ability to withstand exposure to high temperature, low temperature, and temperature variation between two limit temperature. Standard test Condition: $\begin{matrix} 85^{\circ}\text{C} & \sim & 25^{\circ}\text{C} & \sim & -55^{\circ}\text{C} & \sim & 25^{\circ}\text{C} \\ \downarrow & & \downarrow & & \downarrow & & \downarrow \\ 30\text{min} & & 5\text{min} & & 30\text{min} & & 5\text{min} \end{matrix}$ 50 cycle	$I_R \geq U \times 2$ $I_{c(on)} \leq L \times 0.8$ $V_F \geq U \times 1.2$ U : Upper specification limit L : Lower specification limit	n =22 , c=0
Thermal Shock	Evaluates product's ability to withstand rapid temperature change Standard test Condition: $\begin{matrix} 85^{\circ}\text{C} & \sim & -55^{\circ}\text{C} \\ 5\text{min} & & 5\text{min} \end{matrix}$ 50cycle		n =22 , c=0
High Temperature Storage	Evaluates product's ability to withstand prolonged storage at high temperature Standard test Condition: Temperature : 100 °C Time : 1000hrs		n =22 , c=0
Low Temperature Storage	Evaluates product's ability to withstand prolonged storage at low temperature Standard test Condition: Temperature : -55 °C Time : 1000hrs		n =22 , c=0



MODEL NO: ITR8105

Ecn:

Page:7of8

Parameter	Purpose & Condition	Failure Judgement Criteria	Samples(n) Defective(c)
Operating Life Test	Evaluates product's endurance to prolonged electrical or temperature stresses. Standard test Condition: $V_{CE}=5V$ $I_F=20mA$ Time : 1000hrs	$I_R \geq U \times 2$ $I_{c(on)} \leq L \times 0.8$ $V_F \geq U \times 1.2$ U : Upper specification limit	n =22 , c=0
High Temperature High Humidity	Evaluates product's ability to withstand prolonged storage at high temperature and high humidity. Standard test Condition: Temperature: 85°C Relative humidity:85% Time : 1000hrs	L : Lower specification limit	n =22 , c=0
Soldering Heat	Evaluates product's ability to withstand soldering heat Standard test conditions Solder temperature : 260±5°C Solder time : 10 seconds		n =22 , c=0

■Supplements

1.Parts

(1) Chip

Type	Material	Peak Wavelength
IR	GaAs or GaAlAs	940 nm
PT	Silicon	860 nm

(2)Material

Type	Lead frame	Wire	Part Package	Holder
Material	SPCC	Gold	Epoxy	ABS



Packing Specifications

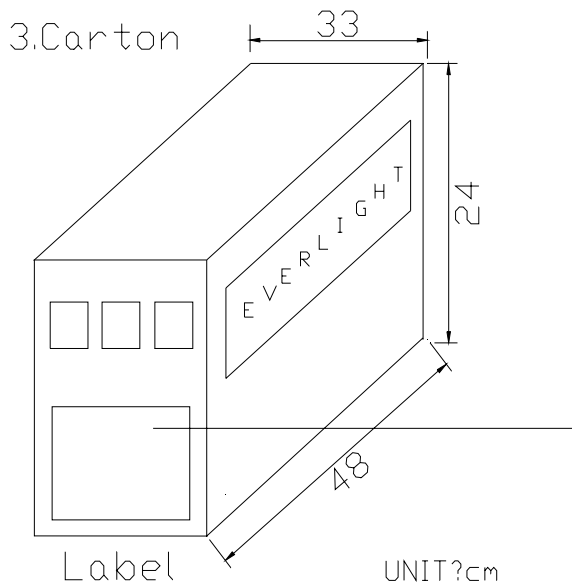
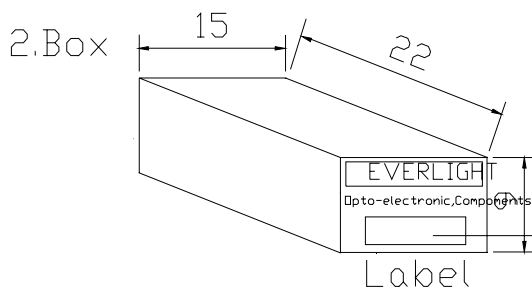
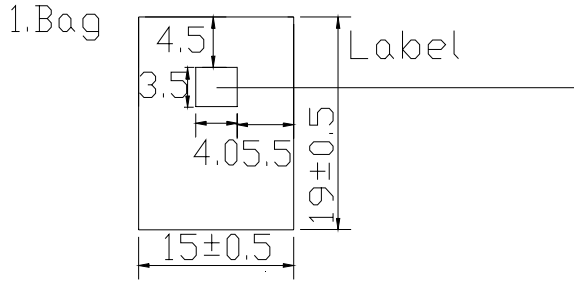

CPN:

P/N:



ITR8105

QTY: 150



LOT NO:

CAT:

HUE:

REF:

MADE IN TAIWAN

CPN : Customer's Product Number

P/N : Product Number

QTY : Packing Quantity

CAT : Ranks

HUE : Peak Wavelength

REF : Reference

LOT NO : Lot Number

MADE IN TAIWAN : Production place

Packing Quantity Specification

1.150Pcs/1Bag , 4Bags/1Box

2.10Boxes/1Carton