



# Technical Data Sheet

## Opto Interrupter

### ITR9606-F

#### ■ Features

- Fast response time
- High analytic
- Cut-off visible wavelength  $\lambda_p=940\text{nm}$
- High sensitivity
- Pb free
- This product itself will remain within RoHS compliant version



#### ■ Descriptions

- The ITR9606-F consist of an infrared emitting diode and an NPN silicon phototransistor, encased side-by-side on converging optical axis in a black thermoplastic housing,
- The phototransistor receives radiation from the IRED only .This is the normal situation.
- But when an object is in between , phototransistor could not receives the radiation.
- For additional component information , please refer to IR928-6C-F and PT928-6C-F

#### ■ Applications

- Mouse Copier
- Switch Scanner
- Floppy disk driver
- Non-contact Switching
- For Direct Board

#### ■ Device Selection Guide

Device No.	Chip Material	LENS COLOR
IR928-6C-F	GaAlAs	Water clear
PT928-6C-F	Silicon	Water clear

**Package Dimensions**

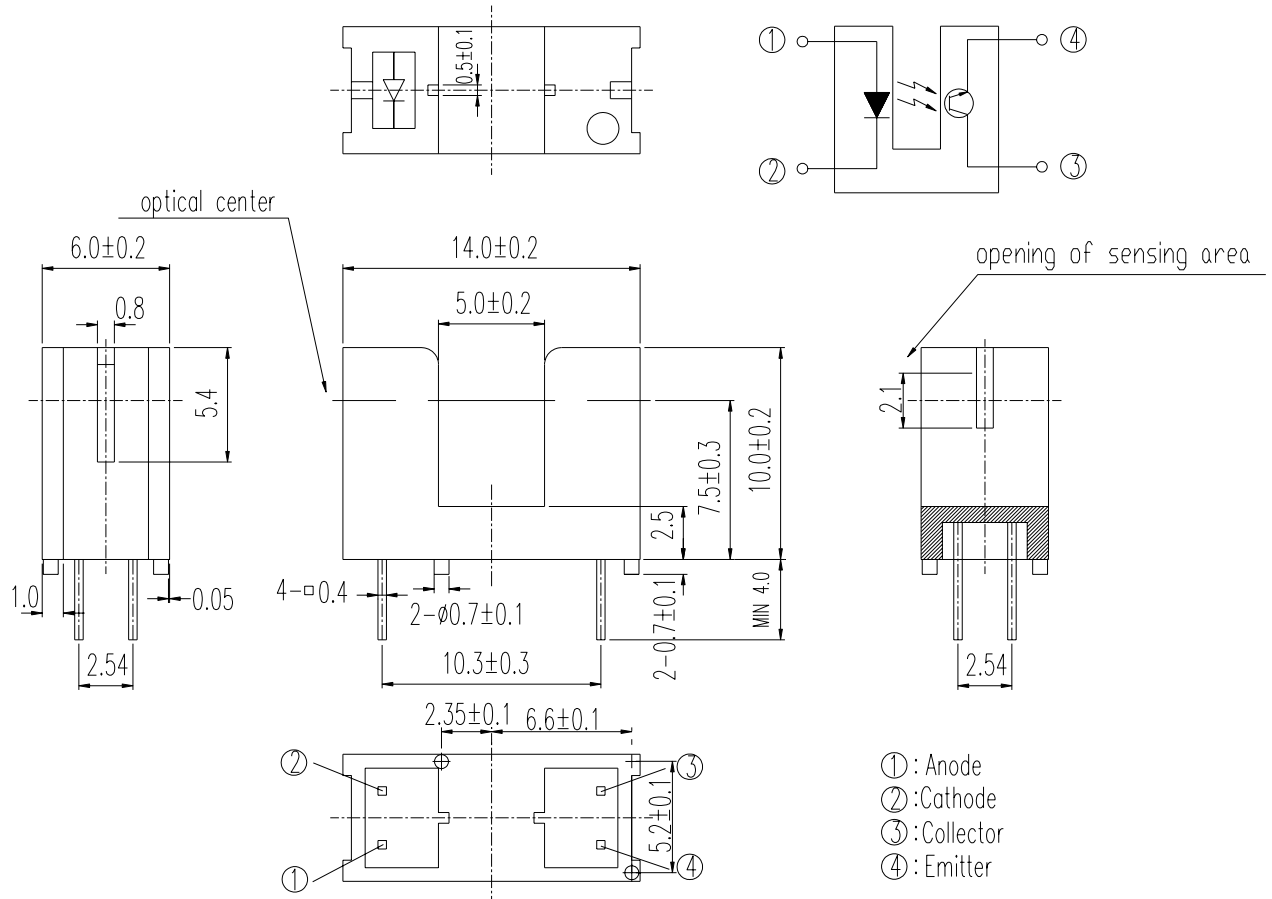

**Notes:**

1. All dimensions are in millimeters
2. Tolerances unless dimensions  $\pm 0.2$ mm
3. Lead spacing is measured where the lead emerge from the package
4. Above specification may be changed without notice. EVERLIGHT will reserve authority on material change for above specification
5. These specification sheets include materials protected under copyright of EVERLIGHT corporation . Please don't reproduce or cause anyone to reproduce them without EVERLIGHT's consent
6. When using this product , please observe the absolute maximum ratings and the instructions for use outlined in these specification sheets. EVERIGHT assumes no responsibility for any damage resulting from use of the product which does not comply with the absolute maximum ratings and the instructions included in these specification sheets.

**Absolute Maximum Ratings (Ta=25°C)**

Parameter		Symbol	Ratings	Unit
Input	Power Dissipation at(or below) 25°C Free Air Temperature	Pd	75	mW
	Reverse Voltage	V <sub>R</sub>	5	V
	Forward Current	I <sub>F</sub>	50	mA
	Peak Forward Current (*1) Pulse width ≤ 100 μs, Duty cycle=1%	I <sub>FP</sub>	1	A
	Collector Power Dissipation	Pd	75	mW
Output	Collector Current	I <sub>C</sub>	20	mA
	Collector-Emitter Voltage	B V <sub>CEO</sub>	30	V
	Emitter-Collector Voltage	B V <sub>ECO</sub>	5	V
	Operating Temperature	Topr	-25~+85	°C
Storage Temperature		Tstg	-40~+85	°C
Lead Soldering Temperature (*2) (1/16 inch form body for 5 seconds)		Tsol	260	°C

(\*1)  $t_w=100 \mu\text{sec.}$ ,  $T=10 \text{msec.}$  (\*2)  $t=5 \text{Sec}$

**Electro-Optical Characteristics (Ta=25°C)**

Parameter		Symbol	Min.	Typ.	Max.	Unit	Conditions
Input	Forward Voltage	V <sub>F</sub>	---	1.2	1.5	V	I <sub>F</sub> =20mA
	Reverse Current	I <sub>R</sub>	---	---	10	μA	V <sub>R</sub> =5V
	Peak Wavelength	λ <sub>P</sub>	---	940	---	nm	I <sub>F</sub> =20mA
	View Angle	2θ1/2	---	60	---	Deg	I <sub>F</sub> =20mA
Output	Dark Current	I <sub>CEO</sub>	---	---	100	nA	V <sub>CE</sub> =20V, Ee=0mW/cm <sup>2</sup>
	C-E Saturation Voltage	V <sub>CE(sat)</sub>	---	---	0.4	V	I <sub>C</sub> =2mA, Ee=1mW/cm <sup>2</sup>
Transfer Characteristics	Collect Current	I <sub>C(ON)</sub>	0.5	---	10	mA	V <sub>CE</sub> =5V
		I <sub>C(OFF)</sub>	---	---	20	μA	I <sub>F</sub> =20mA
	Rise time	t <sub>r</sub>	---	15	---	μsec	V <sub>CE</sub> =5V
	Fall time	t <sub>f</sub>	---	15	---	μsec	I <sub>C</sub> =1mA R <sub>L</sub> =1KΩ

**Typical Electrical/Optical/Characteristics Curves for IR**

Fig.1 Forward Current vs.

Ambient Temperature

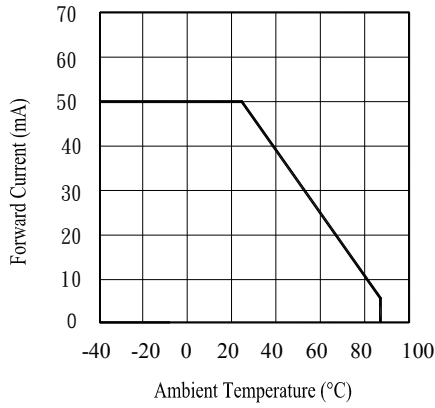

Fig.2 Spectral Distribution

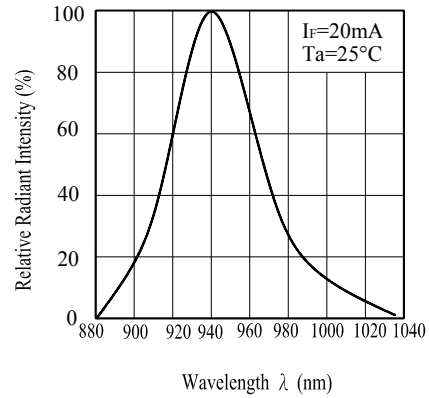

Fig.3 Peak Emission Wavelength vs. Ambient Temperature

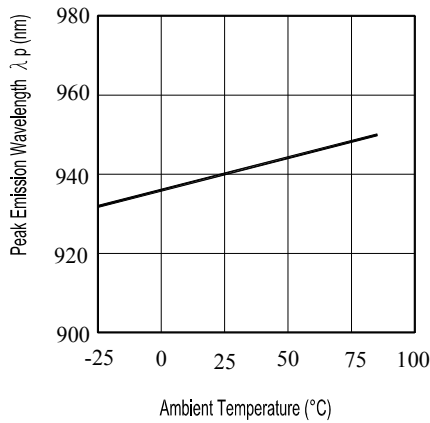

Fig.4 Forward Current vs. Forward Voltage

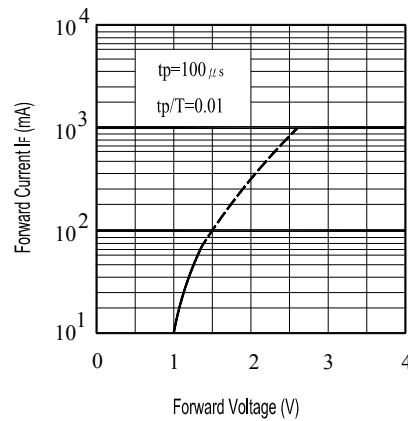

Fig.5 Forward Current vs. Ambient Temperature(°C)

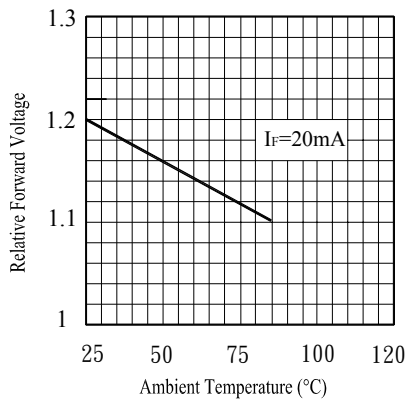
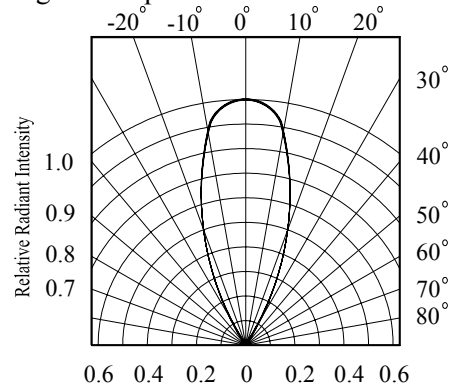

Fig.6 Relative Radiant Intensity vs. Angular Displacement



**Typical Electrical/Optical/Characteristics Curves for PT**

Fig.1 Collector Power Dissipation vs. Ambient Temperature

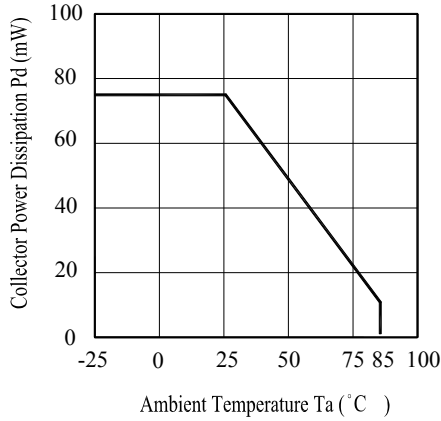

Fig.2 Spectral Sensitivity

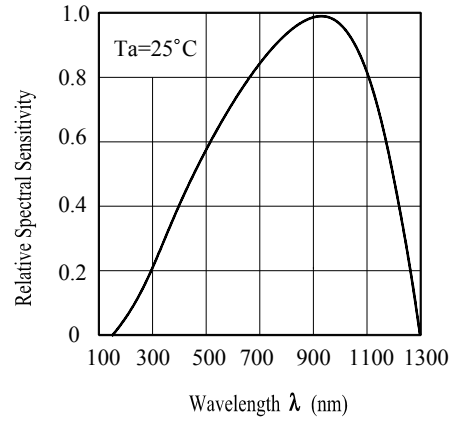

Fig.3 Relative Collector Current vs. Ambient Temperature

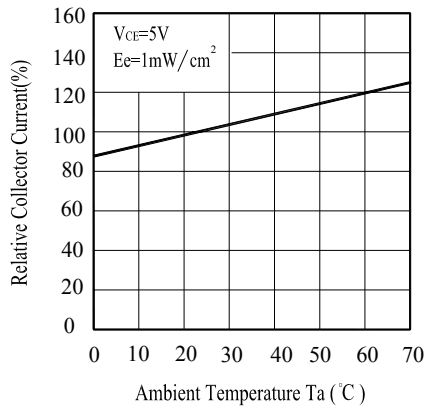

Fig.4 Collector Current vs. Irradiance

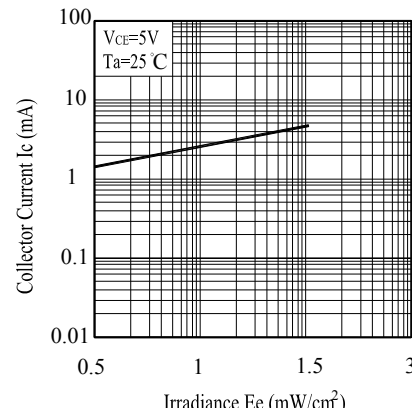

Fig.5 Collector Dark Current vs. Ambient Temperature

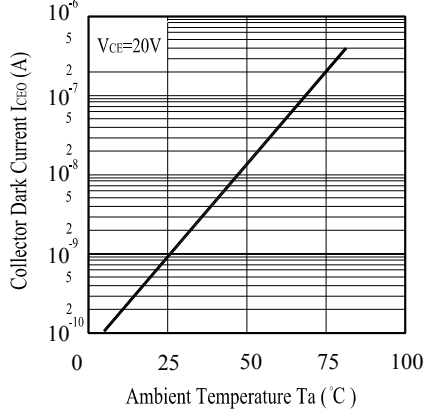
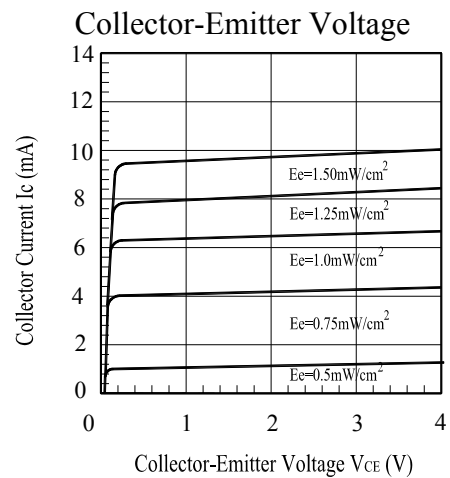

Fig.6 Collector Current vs. Collector-Emitter Voltage



**Reliability Test Item And Condition**

The reliability of products shall be satisfied with items listed below.

Confidence level : 90%

LTPD : 10%

NO.	Item	Test Condition	Test Hours/ Cycle	Sample Size	Failure Judgement Criteria	Ac/Re
1	Solder Heat	TEMP : 260°C ± 5 °C	10 sec	22 PCs	More than 90% of lead to be covered by soldering  $I_R \geq U \times 2$ $E_e \leq L \times 0.8$ $V_F \geq U \times 1.2$  U :Upper specification limit L :Lower specification limit	0/1
2	Temperature Cycle	H : +100°C    15 min $\updownarrow$ 5 min $\updownarrow$ L : -40°C    15 min	300 cycle	22 PCs		0/1
3	Thermal Shock	H : +100°C    5 min $\updownarrow$ 10 sec $\updownarrow$ L : -10°C    5 min	300 cycle	22 PCs		0/1
4	High Temperature Storage	TEMP. : +100°C	1000 hrs	22 PCs		0/1
5	Low Temperature Storage	TEMP. : -40°C	1000 hrs	22 PCs		0/1
6	DC Operating Life	$V_{CE}=5V$ $I_F=20mA$	1000 hrs	22 PCs		0/1
7	High Temperature / High Humidity	85°C / 85% R.H.	1000 hrs	22 PCs		0/1



### **Packing Quantity Specification**

1. 35pcs/Tube, 100 Tubes/Box, 4 boxes/Chect

### **Label Form Specification**

CPN:	CPN: Customer's Production Number
P/N:	P/N : Production Number
	QTY: Packing Quantity
ITR9606-F	CAT: Ranks
QTY:	HUE: Peak Wavelength
	REF: Reference
CAT:	LOT No: Lot Number
HUE:	
REF:	
LOT NO:	

### **Notes**

1. Above specification may be changed without notice. EVERLIGHT will reserve authority on material change for above specification.
2. When using this product, please observe the absolute maximum ratings and the instructions for using outlined in these specification sheets. EVERLIGHT assumes no responsibility for any damage resulting from use of the product which does not comply with the absolute maximum ratings and the instructions included in these specification sheets.

These specification sheets include materials protected under copyright of EVERLIGHT corporation. Please don't reproduce or cause anyone to reproduce them without EVERLIGHT's consent.

**EVERLIGHT ELECTRONICS CO., LTD.**  
Office: No 25, Lane 76, Sec 3, Chung Yang Rd,  
Tucheng, Taipei 236, Taiwan, R.O.C

Tel: 886-2-2267-2000, 2267-9936  
Fax: 886-2267-6244, 2267-6189, 2267-6306  
<http://www.everlight.com>