

“ZNR” Transient/Surge Absorbers, SMD Moded Case Type

Type: **VF**
 Type: **CF**
 Type: **SF**



■ Features

- Large withstanding surge current capability, compact size
- Designed for flow/reflow soldering
- Excellent response against high steep surge voltages
- Low clamping voltage for better surge protection

■ Recommended Applications

- Protection of communication module (Modems, xDSLs, Terminal Adaptes)
- Protection of consumer equipment
- Protection of industrial equipment
- Protection of automobile equipment
- Absorption of switching surge from relays

■ Handling Precautions

See Pages 134 to 136

■ Explanation of Part Numbers

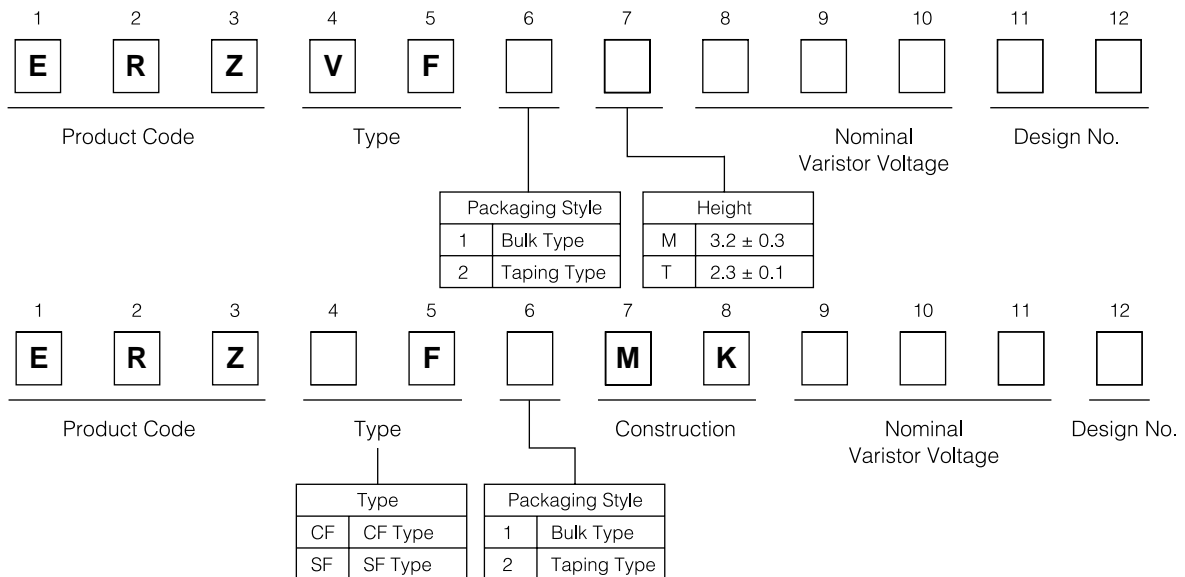

■ Construction

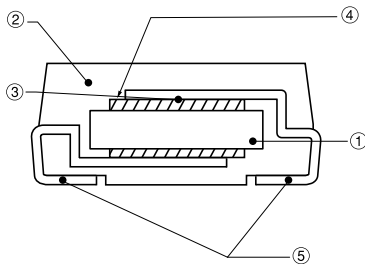

| | |
|-----------------------|-------------------------------|
| ① ZNR element | ZnO etc. |
| ② Resin mold | Epoxy Resin(UL94V-0 approved) |
| ③ Conductive adhesive | Silver |
| ④ Electrode | Silver |
| ⑤ Lead terminals | Soldered Ni-Fe Alloy |

■ Dimensions in mm (not to scale)

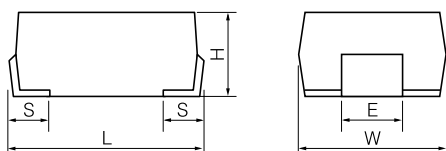

| Type | W | L | H | S | E |
|------|---------|---------|---------|---------|---------|
| VF□M | 6.0±0.4 | 8.0±0.5 | 3.2±0.3 | 1.3±0.3 | 2.5±0.2 |
| VF□T | 6.0±0.4 | 8.0±0.5 | 2.3±0.1 | 1.3±0.3 | 2.5±0.2 |
| CF | 6.0±0.4 | 8.0±0.5 | 3.2±0.3 | 1.3±0.3 | 2.5±0.2 |
| SF | 6.2±0.4 | | | | |

Rev.02/04

■ Ratings and Characteristics

- Operating Temperature Range: -40 to 85 °C
- Storage Temperature Range: -40 to 125 °C
- Temperature Coefficient of Varistor Voltage: 0 to -0.05 %/°C

| Part No. | Varistor Voltage | Maximum Allowable Voltage | | Clamping Voltage at I _p (max.) | | Rated Power (W) | Maximum Energy (2 ms) (W) | Maximum Peak Current (8/20 μs, 2 times) (A) | |
|-----------|----------------------|---------------------------|--------|---|--------------------|-----------------|---------------------------|---|-----|
| | V _{1mA} (V) | ACrms (V) | DC (V) | V _{xA} (V) | I _p (A) | | | | |
| Type VF□M | *ERZVF□M220 | 22(20~ 24) | 14 | 18 | 43 | 2.5 | 0.01 | 0.5 | 125 |
| | *ERZVF□M270 | 27(24~ 30) | 17 | 22 | 53 | 2.5 | 0.01 | 0.7 | 125 |
| | *ERZVF□M330 | 33(30~ 36) | 20 | 26 | 65 | 2.5 | 0.01 | 0.8 | 125 |
| | *ERZVF□M390 | 39(35~ 43) | 25 | 31 | 77 | 2.5 | 0.01 | 0.9 | 125 |
| | *ERZVF□M470 | 47(42~ 52) | 30 | 38 | 93 | 2.5 | 0.01 | 1.1 | 125 |
| | *ERZVF□M560 | 56(50~ 62) | 35 | 45 | 110 | 2.5 | 0.01 | 1.3 | 125 |
| | *ERZVF□M680 | 68(61~ 75) | 40 | 56 | 135 | 2.5 | 0.01 | 1.6 | 125 |
| | ERZVF□M820 | 82(74~ 90) | 50 | 65 | 135 | 10 | 0.1 | 2.5 | 600 |
| | ERZVF□M101 | 100(90~110) | 60 | 85 | 165 | 10 | 0.1 | 3.0 | 600 |
| | ERZVF□M121 | 120(108~132) | 75 | 100 | 200 | 10 | 0.1 | 3.5 | 600 |
| | ERZVF□M151 | 150(135~165) | 95 | 125 | 250 | 10 | 0.1 | 4.5 | 600 |
| | ERZVF□M201 | 200(185~225) | 130 | 170 | 340 | 10 | 0.1 | 6.0 | 600 |
| | ERZVF□M221 | 220(198~242) | 140 | 180 | 360 | 10 | 0.1 | 6.5 | 600 |
| | ERZVF□M241 | 240(216~264) | 150 | 200 | 395 | 10 | 0.1 | 7.5 | 600 |
| | ERZVF□M271 | 270(247~303) | 175 | 225 | 455 | 10 | 0.1 | 8.0 | 600 |
| | *ERZVF□M331 | 330(297~363) | 210 | 270 | 545 | 10 | 0.1 | 8.0 | 300 |
| | *ERZVF□M361 | 360(324~396) | 230 | 300 | 595 | 10 | 0.1 | 9.0 | 300 |
| | *ERZVF□M391 | 390(351~429) | 250 | 320 | 650 | 10 | 0.1 | 9.0 | 300 |
| | *ERZVF□M431 | 430(387~473) | 275 | 350 | 710 | 10 | 0.1 | 10.0 | 300 |
| | *ERZVF□M471 | 470(423~517) | 300 | 385 | 775 | 10 | 0.1 | 10.0 | 300 |

└ Packaging Style Code: "1" for bulk, "2" for embossed taping

| Part No. | Varistor Voltage | Maximum Allowable Voltage | | Clamping Voltage at I _p (max.) | | Rated Power (W) | Maximum Energy (2 ms) (W) | Maximum Peak Current (8/20 μs, 2 times) (A) | |
|-----------|----------------------|---------------------------|--------|---|--------------------|-----------------|---------------------------|---|-----|
| | V _{1mA} (V) | ACrms (V) | DC (V) | V _{xA} (V) | I _p (A) | | | | |
| Type VF□T | ERZVF□T820 | 82(74~ 90) | 50 | 65 | 145 | 5 | 0.1 | 1.7 | 400 |
| | ERZVF□T101 | 100(90~110) | 60 | 85 | 175 | 5 | 0.1 | 2.0 | 400 |
| | ERZVF□T151 | 150(135~165) | 95 | 125 | 260 | 5 | 0.1 | 3.0 | 400 |
| | ERZVF□T241 | 240(216~264) | 150 | 200 | 415 | 5 | 0.1 | 5.0 | 400 |
| | ERZVF□T271 | 270(247~303) | 175 | 225 | 475 | 5 | 0.1 | 6.0 | 400 |

└ Packaging Style Code: "1" for bulk, "2" for embossed taping

■ Ratings and Characteristics

- Operating Temperature Range: -40 to 85 °C
- Storage Temperature Range: -40 to 125 °C
- Temperature Coefficient of Varistor Voltage: 0 to -0.05 %/°C

| Part No. | Varistor Voltage | Maximum Allowable Voltage | | Clamping Voltage at I _p (max.) | | Rated Power (W) | Maximum Energy (2 ms) (J) | Maximum Peak Current (8/20 μs, 2 times) (A) | |
|-------------|------------------------|---------------------------|--------|---|--------------------|-----------------|---------------------------|---|-----|
| | V _{0.1mA} (V) | ACrms (V) | DC (V) | V _{xA} (V) | I _p (A) | | | | |
| Type CF | ERZCF□MK220 | 22 (20– 24) | 14 | 18 | 48 | 1 | 0.01 | 0.4 | 50 |
| | ERZCF□MK270 | 27 (24– 30) | 17 | 22 | 60 | 1 | 0.01 | 0.5 | 50 |
| | ERZCF□MK330 | 33 (30– 36) | 20 | 26 | 73 | 1 | 0.01 | 0.6 | 50 |
| | ERZCF□MK390 | 39 (35– 43) | 25 | 31 | 86 | 1 | 0.01 | 0.8 | 50 |
| | ERZCF□MK470 | 47 (42– 52) | 30 | 38 | 104 | 1 | 0.01 | 1.0 | 50 |
| | ERZCF□MK560 | 56 (50– 62) | 35 | 45 | 123 | 1 | 0.01 | 1.0 | 50 |
| | ERZCF□MK680 | 68 (61– 75) | 40 | 56 | 150 | 1 | 0.01 | 1.2 | 50 |
| | ERZCF□MK820 | 82 (74– 90) | 50 | 65 | 145 | 5 | 0.1 | 1.7 | 200 |
| | ERZCF□MK101 | 100 (90–110) | 60 | 85 | 175 | 5 | 0.1 | 2.0 | 200 |
| | ERZCF□MK121 | 120 (108–132) | 75 | 100 | 210 | 5 | 0.1 | 2.5 | 200 |
| | ERZCF□MK151 | 150 (135–165) | 95 | 125 | 260 | 5 | 0.1 | 3.0 | 200 |
| | ERZCF□MK201 | 200 (185–225) | 130 | 170 | 355 | 5 | 0.1 | 4.0 | 200 |
| | ERZCF□MK221 | 220 (198–242) | 140 | 180 | 380 | 5 | 0.1 | 4.5 | 200 |
| | ERZCF□MK241 | 240 (216–264) | 150 | 200 | 415 | 5 | 0.1 | 5.0 | 200 |
| | ERZCF□MK271 | 270 (247–303) | 175 | 225 | 475 | 5 | 0.1 | 6.0 | 200 |
| | ERZCF□MK361 | 360 (324–396) | 230 | 300 | 620 | 5 | 0.1 | 6.0 | 200 |
| | ERZCF□MK391 | 390 (351–429) | 250 | 320 | 675 | 5 | 0.1 | 6.0 | 200 |
| | ERZCF□MK431 | 430 (387–473) | 275 | 350 | 745 | 5 | 0.1 | 6.3 | 200 |
| ERZCF□MK471 | 470 (423–517) | 300 | 385 | 810 | 5 | 0.1 | 7.0 | 200 | |

↑ Packaging Style Code: “1” for bulk, “2” for embossed taping

| Part No. | Varistor Voltage | Maximum Allowable Voltage | | Clamping Voltage at I _p (max.) | | Rated Power (W) | Maximum Energy (2 ms) (J) | Maximum Peak Current (8/20 μs, 2 times) (A) | |
|-------------|----------------------|---------------------------|--------|---|--------------------|-----------------|---------------------------|---|-----|
| | V _{1mA} (V) | ACrms (V) | DC (V) | V _{xA} (V) | I _p (A) | | | | |
| Type SF | ERZSF□MK220 | 22 (20– 25) | 14 | 18 | 43 | 2.5 | 0.02 | 0.9 | 125 |
| | ERZSF□MK270 | 27 (24– 30) | 17 | 22 | 53 | 2.5 | 0.02 | 1.0 | 125 |
| | ERZSF□MK330 | 33 (30– 36) | 20 | 26 | 65 | 2.5 | 0.02 | 1.2 | 125 |
| | ERZSF□MK390 | 39 (35– 43) | 25 | 31 | 77 | 2.5 | 0.02 | 1.5 | 125 |
| | ERZSF□MK470 | 47 (42– 52) | 30 | 38 | 93 | 2.5 | 0.02 | 1.8 | 125 |
| | ERZSF□MK560 | 56 (50– 62) | 35 | 45 | 110 | 2.5 | 0.02 | 2.2 | 125 |
| | ERZSF□MK680 | 68 (61– 75) | 40 | 56 | 135 | 2.5 | 0.02 | 2.5 | 125 |
| | ERZSF□MK820 | 82 (74– 90) | 50 | 65 | 135 | 10 | 0.25 | 3.5 | 600 |
| | ERZSF□MK101 | 100 (90–110) | 60 | 85 | 165 | 10 | 0.25 | 4.0 | 600 |
| | ERZSF□MK121 | 120 (108–132) | 75 | 100 | 200 | 10 | 0.25 | 5.0 | 600 |
| | ERZSF□MK151 | 150 (135–165) | 95 | 125 | 250 | 10 | 0.25 | 6.0 | 600 |
| | ERZSF□MK201 | 200 (185–225) | 130 | 170 | 340 | 10 | 0.25 | 8.0 | 600 |
| | ERZSF□MK221 | 220 (198–242) | 140 | 180 | 360 | 10 | 0.25 | 9.0 | 600 |
| | ERZSF□MK241 | 240 (216–264) | 150 | 200 | 395 | 10 | 0.25 | 10.0 | 600 |
| | ERZSF□MK271 | 270 (247–303) | 175 | 225 | 455 | 10 | 0.25 | 12.0 | 600 |
| | ERZSF□MK361 | 360 (324–396) | 230 | 300 | 595 | 10 | 0.20 | 12.0 | 400 |
| | ERZSF□MK391 | 390 (351–429) | 250 | 320 | 650 | 10 | 0.20 | 12.0 | 400 |
| | ERZSF□MK431 | 430 (387–473) | 275 | 350 | 710 | 10 | 0.20 | 14.0 | 400 |
| ERZSF□MK471 | 470 (423–517) | 300 | 385 | 775 | 10 | 0.20 | 14.0 | 400 | |

↑ Packaging Style Code: “1” for bulk, “2” for embossed taping

■ Typical Characteristics

■ Voltage vs. Current

■ ERZVF1(2)M220 to ERZVF1(2)M680

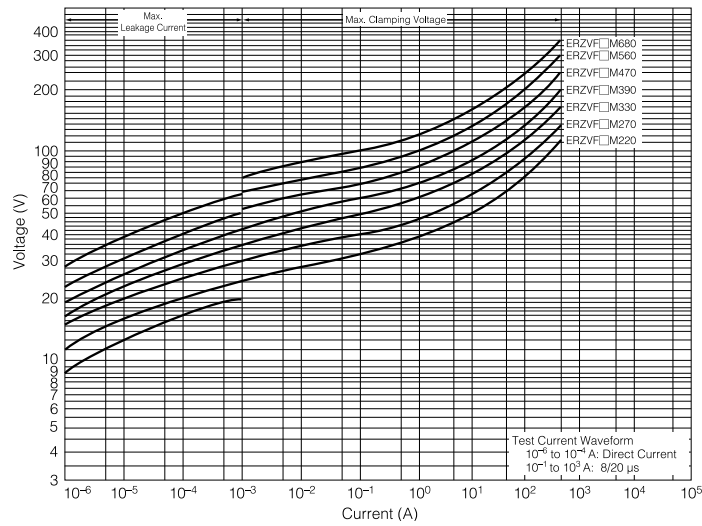

■ Impulse

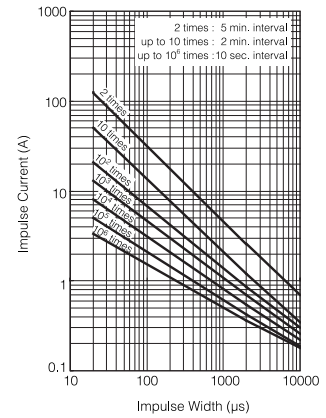

■ ERZVF1(2)M820 to ERZVF1(2)M471

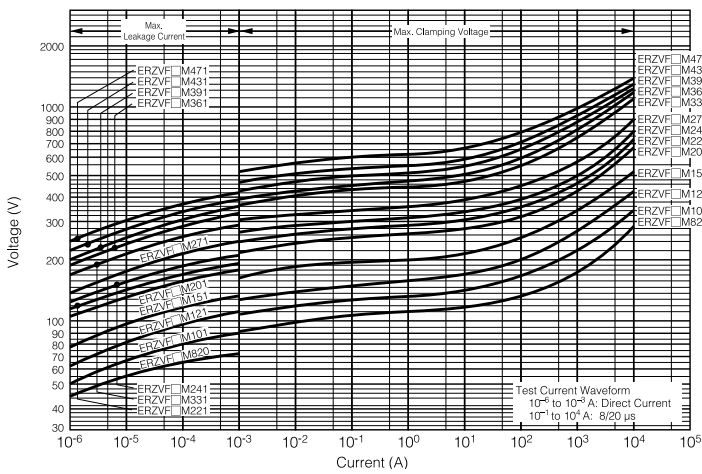

ERZVF1(2)M820 to ERZVF1(2)M271

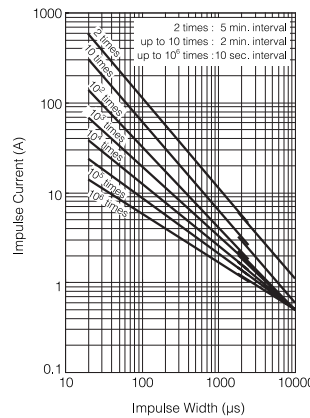

ERZVF1(2)M331 to ERZVF1(2)M471

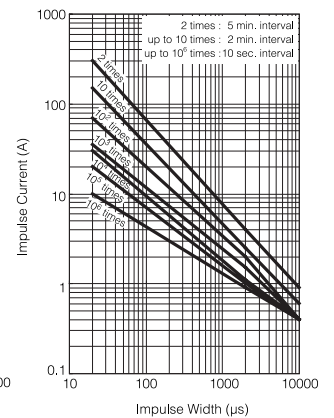

■ ERZVF1(2)T820 to ERZVF1(2)T271

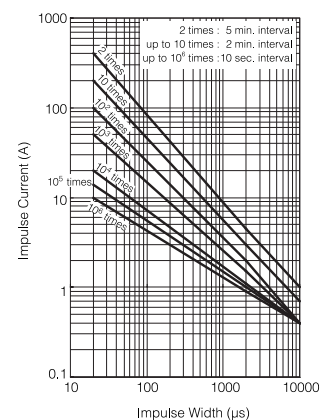
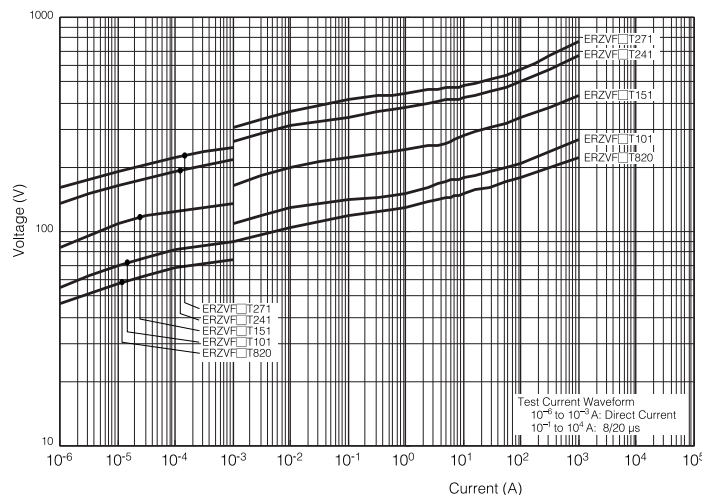

■ Typical Characteristics

■ Voltage vs. Current

■ ERZCF1 (2) MK220 to ERZCF1 (2) MK680

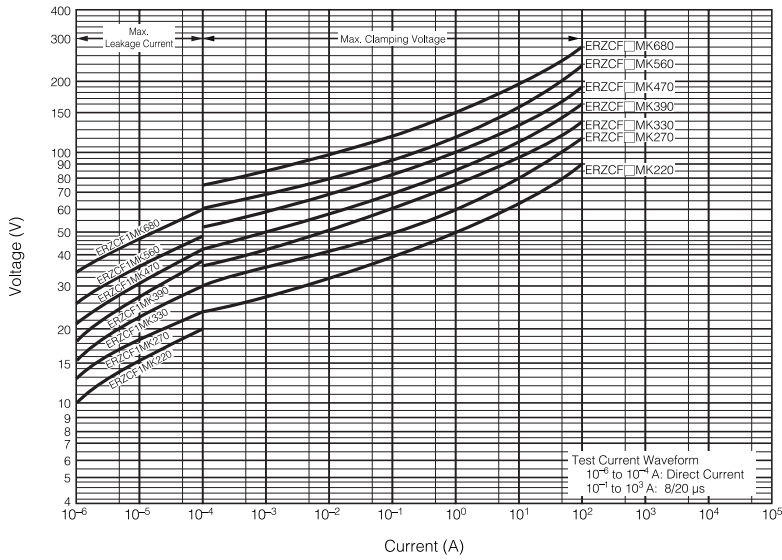

■ Impulse

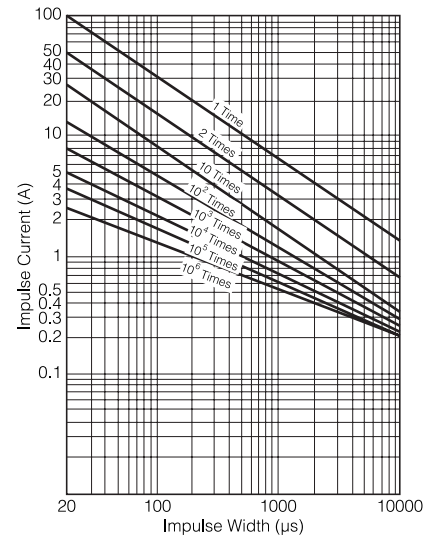

■ ERZCF1 (2) MK820 to ERZCF1 (2) MK471

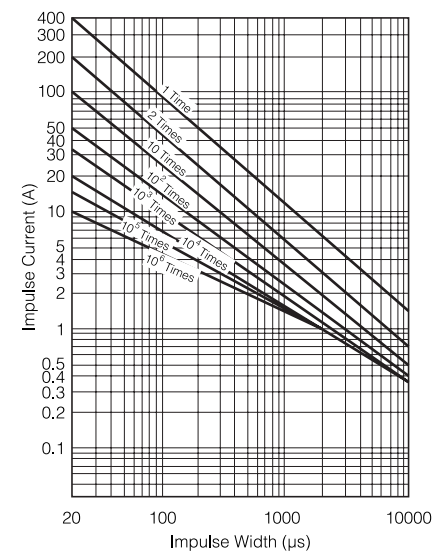
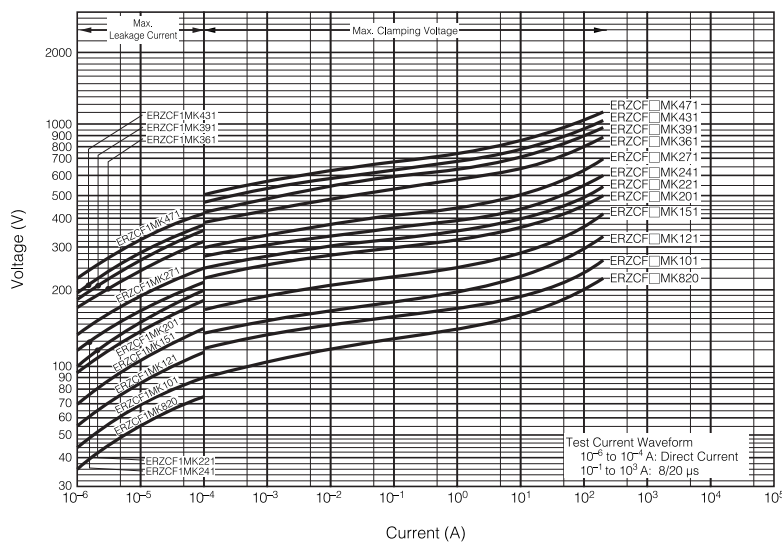

■ Typical Characteristics

■ Voltage vs. Current

■ ERZSF1 (2) MK220 to ERZSF1 (2) MK680

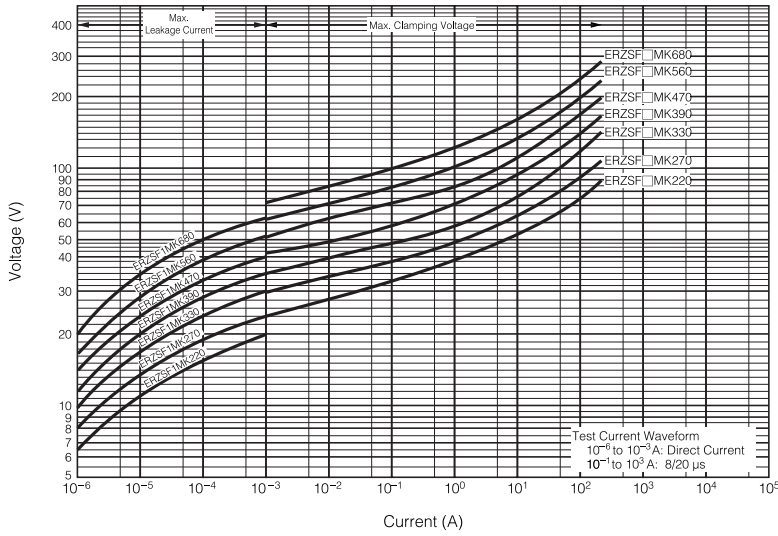

■ Impulse

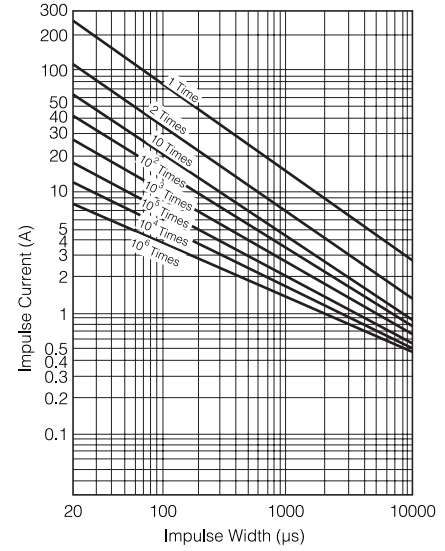

■ ERZSF1 (2) MK820 to ERZSF1 (2) MK471

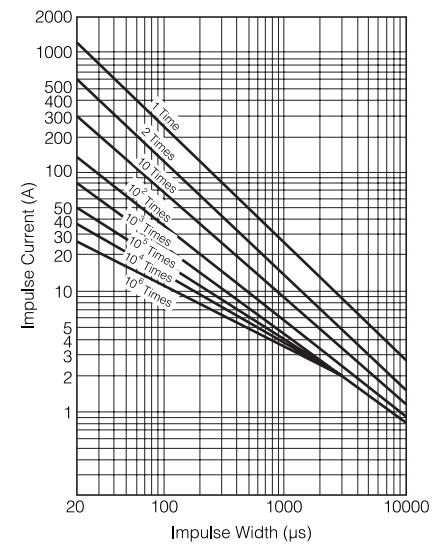
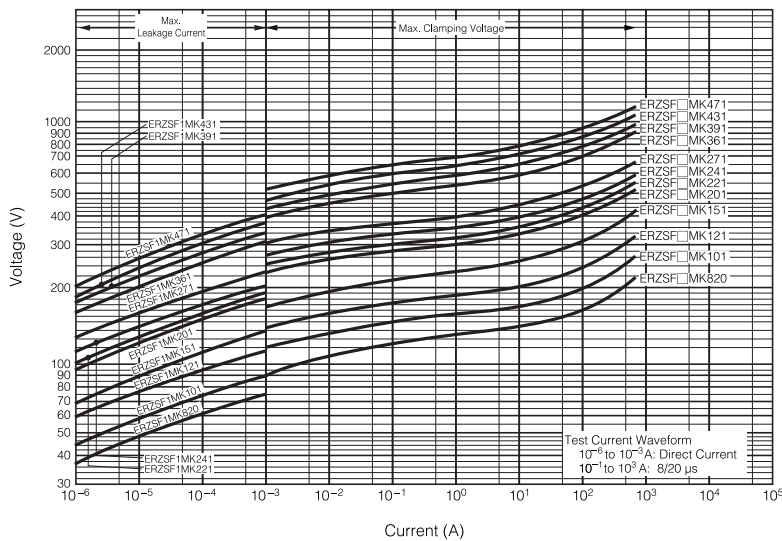

■ Marking Contents

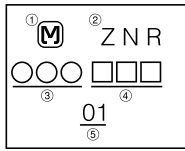

| | |
|----------------------------|---|
| ① Trade Mark | Trade Mark |
| ② Product Name | ZNR |
| ③ Type | VF□M Type:VFM, VF□T Type:VFT CF Type:FK, SF Type:SF |
| ④ Abbreviation of Part No. | The first two digits are significant figures and the third one denotes the number of zeros following. |
| ⑤ Date Code | Left(Year): 2002:B, 2003:C, 2004:D, 2005:E, 2006:F Right(Month): Jan. to Sep.:1 to 9, Oct.:0, Nov.:N, Dec.:D |

■ Packaging Specifications

● Packing Quantity

| Size Code | Style | Embossed taping | Bulk |
|----------------------------|-------|-----------------|--------------|
| “VF□M”, “VF□T”, “CF”, “SF” | | 2000 pcs./reel | 200 pcs./bag |

● Reel

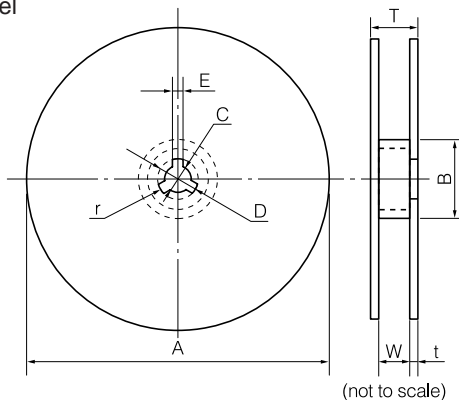

| | | | | | |
|-----------------|-----------------------------------|-----------|----------|----------|---------|
| Dimensions (mm) | A | B | C | D | E |
| | 382 max. | 50 min. | 13.0±0.5 | 21.0±0.8 | 2.0±0.5 |
| Dimensions (mm) | W | T | t | r | |
| | 16.4 ^{+2.0} ₀ | 22.4 max. | 2.5±0.5 | 1.0 | |

● Embossed Taping

(W=16 mm)

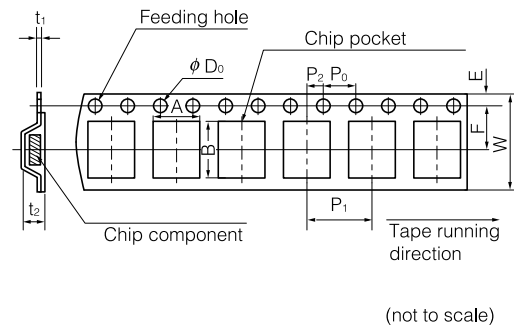

| | | | | | | |
|-----------------|----------------|----------------|----------------------------------|----------------|----------------|----------------|
| Dimensions (mm) | A | B | W | F | E | P ₁ |
| | 6.8±0.2 | 11.9 max. | 16.0±0.3 | 7.5±0.1 | 1.75±0.10 | 8.0±0.1 |
| Dimensions (mm) | P ₂ | P ₀ | φD ₀ | t ₁ | t ₂ | |
| | 2.0±0.1 | 4.0±0.1 | 1.5 ^{+0.1} ₀ | 0.6 max. | 6.5 max. | |

■ Performance Characteristics

| Characteristics | Test Methods | Specifications | | | | | | | | | | | | | | | | | | | | | | | | | | | | | | | | | | | | |
|---|--|----------------------------------|--------------|----------|---------|------|--------------------------|--------------|-----|--------------------------|--------------|------|--------------------------|--------------|------|------|--------------------------|--------------|------|----|----------------------------|------|--------|--|----------------------------|--------------|------|----|----------------------------|--------------|------|----------------------------|--------------|------|----------------------------|--------------|------|--|
| Standard Test Condition | Electrical measurements (initial/after tests) shall be conducted at temperature of 5 to 35 °C, relative humidity maximum of 85 % | — | | | | | | | | | | | | | | | | | | | | | | | | | | | | | | | | | | | | |
| Varistor Voltage | The voltage between two terminals with the specified measuring current C_{mA} DC applied is called V_c or V_{CmA} . The measurement shall be made as fast as possible to avoid heating effects. | To meet the specified value. | | | | | | | | | | | | | | | | | | | | | | | | | | | | | | | | | | | | |
| Maximum Allowable Voltage | The recommended maximum sinusoidal wave voltage (rms) or the maximum DC voltage that can be applied continuously. | | | | | | | | | | | | | | | | | | | | | | | | | | | | | | | | | | | | | |
| Clamping Voltage | The maximum voltage between two terminals with the specified impulse current (8/20 μ s). | | | | | | | | | | | | | | | | | | | | | | | | | | | | | | | | | | | | | |
| Rated Power | The maximum power that can be applied within the specified ambient temperature. | | | | | | | | | | | | | | | | | | | | | | | | | | | | | | | | | | | | | |
| Maximum Energy | Maximum energy at less than ± 10 % of varistor voltage change when the standard impulse (2 ms) is applied one time. | | | | | | | | | | | | | | | | | | | | | | | | | | | | | | | | | | | | | |
| Maximum Peak Current | Maximum current at less than ± 10 % of varistor voltage change when impulse current (8/20 μ s) is applied two times continuously with the interval of 5 minutes. | | | | | | | | | | | | | | | | | | | | | | | | | | | | | | | | | | | | | |
| Temperature Coefficient of Varistor Voltage | $\frac{V_{CmA} \text{ at } 85\text{ }^\circ\text{C} - V_{CmA} \text{ at } 25\text{ }^\circ\text{C}}{V_{CmA} \text{ at } 25\text{ }^\circ\text{C}} \times \frac{1}{60} \times 100(\%/^\circ\text{C})$ | 0 to -0.05 %/ $^\circ\text{C}$ | | | | | | | | | | | | | | | | | | | | | | | | | | | | | | | | | | | | |
| Impulse Life (I) | <p>The change of V_c shall be measured after the specified impulse is applied 10000 times continuously with the interval of 10 seconds at room temperature.</p> <table border="1"> <thead> <tr> <th>Type</th> <th>Part Number</th> <th>Waveform</th> <th>Current</th> </tr> </thead> <tbody> <tr> <td rowspan="3">VF□M</td> <td>ERZVF□M220 to ERZVF□M680</td> <td>8/20 μs</td> <td>8 A</td> </tr> <tr> <td>ERZVF□M820 to ERZVF□M271</td> <td>8/20 μs</td> <td>40 A</td> </tr> <tr> <td>ERZVF□M331 to ERZVF□M471</td> <td>8/20 μs</td> <td>30 A</td> </tr> <tr> <td rowspan="2">VF□T</td> <td>ERZVF□T820 to ERZVF□T271</td> <td>8/20 μs</td> <td>20 A</td> </tr> <tr> <td rowspan="2">CF</td> <td>ERZCF□MK220 to ERZCF□MK680</td> <td>2 ms</td> <td>0.5 A</td> </tr> <tr> <td></td> <td>ERZCF□MK820 to ERZCF□MK471</td> <td>8/20 μs</td> <td>20 A</td> </tr> <tr> <td rowspan="3">SF</td> <td>ERZSF□MK220 to ERZSF□MK680</td> <td>8/20 μs</td> <td>18 A</td> </tr> <tr> <td>ERZSF□MK820 to ERZSF□MK271</td> <td>8/20 μs</td> <td>50 A</td> </tr> <tr> <td>ERZSF□MK331 to ERZSF□MK471</td> <td>8/20 μs</td> <td>40 A</td> </tr> </tbody> </table> | Type | Part Number | Waveform | Current | VF□M | ERZVF□M220 to ERZVF□M680 | 8/20 μ s | 8 A | ERZVF□M820 to ERZVF□M271 | 8/20 μ s | 40 A | ERZVF□M331 to ERZVF□M471 | 8/20 μ s | 30 A | VF□T | ERZVF□T820 to ERZVF□T271 | 8/20 μ s | 20 A | CF | ERZCF□MK220 to ERZCF□MK680 | 2 ms | 0.5 A | | ERZCF□MK820 to ERZCF□MK471 | 8/20 μ s | 20 A | SF | ERZSF□MK220 to ERZSF□MK680 | 8/20 μ s | 18 A | ERZSF□MK820 to ERZSF□MK271 | 8/20 μ s | 50 A | ERZSF□MK331 to ERZSF□MK471 | 8/20 μ s | 40 A | $\Delta V_{CmA}/V_{CmA} \leq \pm 10$ % |
| Type | Part Number | Waveform | Current | | | | | | | | | | | | | | | | | | | | | | | | | | | | | | | | | | | |
| VF□M | ERZVF□M220 to ERZVF□M680 | 8/20 μ s | 8 A | | | | | | | | | | | | | | | | | | | | | | | | | | | | | | | | | | | |
| | ERZVF□M820 to ERZVF□M271 | 8/20 μ s | 40 A | | | | | | | | | | | | | | | | | | | | | | | | | | | | | | | | | | | |
| | ERZVF□M331 to ERZVF□M471 | 8/20 μ s | 30 A | | | | | | | | | | | | | | | | | | | | | | | | | | | | | | | | | | | |
| VF□T | ERZVF□T820 to ERZVF□T271 | 8/20 μ s | 20 A | | | | | | | | | | | | | | | | | | | | | | | | | | | | | | | | | | | |
| | CF | ERZCF□MK220 to ERZCF□MK680 | 2 ms | 0.5 A | | | | | | | | | | | | | | | | | | | | | | | | | | | | | | | | | | |
| | | ERZCF□MK820 to ERZCF□MK471 | 8/20 μ s | 20 A | | | | | | | | | | | | | | | | | | | | | | | | | | | | | | | | | | |
| SF | ERZSF□MK220 to ERZSF□MK680 | 8/20 μ s | 18 A | | | | | | | | | | | | | | | | | | | | | | | | | | | | | | | | | | | |
| | ERZSF□MK820 to ERZSF□MK271 | 8/20 μ s | 50 A | | | | | | | | | | | | | | | | | | | | | | | | | | | | | | | | | | | |
| | ERZSF□MK331 to ERZSF□MK471 | 8/20 μ s | 40 A | | | | | | | | | | | | | | | | | | | | | | | | | | | | | | | | | | | |
| Impulse Life (II) | <p>The change of V_c shall be measured after the specified impulse is applied 100000 times continuously with the interval of 10 seconds at room temperature.</p> <table border="1"> <thead> <tr> <th>Type</th> <th>Part Number</th> <th>Waveform</th> <th>Current</th> </tr> </thead> <tbody> <tr> <td rowspan="3">VF□M</td> <td>ERZVF□M220 to ERZVF□M680</td> <td>8/20 μs</td> <td>5 A</td> </tr> <tr> <td>ERZVF□M820 to ERZVF□M271</td> <td>8/20 μs</td> <td>25 A</td> </tr> <tr> <td>ERZVF□M331 to ERZVF□M471</td> <td>8/20 μs</td> <td>20 A</td> </tr> <tr> <td rowspan="2">VF□T</td> <td>ERZVF□T820 to ERZVF□T271</td> <td>8/20 μs</td> <td>14 A</td> </tr> <tr> <td rowspan="2">CF</td> <td>ERZCF□MK220 to ERZCF□MK680</td> <td>2 ms</td> <td>0.45 A</td> </tr> <tr> <td></td> <td>ERZCF□MK820 to ERZCF□MK471</td> <td>8/20 μs</td> <td>14 A</td> </tr> <tr> <td rowspan="3">SF</td> <td>ERZSF□MK220 to ERZSF□MK680</td> <td>8/20 μs</td> <td>12 A</td> </tr> <tr> <td>ERZSF□MK820 to ERZSF□MK271</td> <td>8/20 μs</td> <td>35 A</td> </tr> <tr> <td>ERZSF□MK331 to ERZSF□MK471</td> <td>8/20 μs</td> <td>28 A</td> </tr> </tbody> </table> | Type | Part Number | Waveform | Current | VF□M | ERZVF□M220 to ERZVF□M680 | 8/20 μ s | 5 A | ERZVF□M820 to ERZVF□M271 | 8/20 μ s | 25 A | ERZVF□M331 to ERZVF□M471 | 8/20 μ s | 20 A | VF□T | ERZVF□T820 to ERZVF□T271 | 8/20 μ s | 14 A | CF | ERZCF□MK220 to ERZCF□MK680 | 2 ms | 0.45 A | | ERZCF□MK820 to ERZCF□MK471 | 8/20 μ s | 14 A | SF | ERZSF□MK220 to ERZSF□MK680 | 8/20 μ s | 12 A | ERZSF□MK820 to ERZSF□MK271 | 8/20 μ s | 35 A | ERZSF□MK331 to ERZSF□MK471 | 8/20 μ s | 28 A | $\Delta V_{CmA}/V_{CmA} \leq \pm 10$ % |
| Type | Part Number | Waveform | Current | | | | | | | | | | | | | | | | | | | | | | | | | | | | | | | | | | | |
| VF□M | ERZVF□M220 to ERZVF□M680 | 8/20 μ s | 5 A | | | | | | | | | | | | | | | | | | | | | | | | | | | | | | | | | | | |
| | ERZVF□M820 to ERZVF□M271 | 8/20 μ s | 25 A | | | | | | | | | | | | | | | | | | | | | | | | | | | | | | | | | | | |
| | ERZVF□M331 to ERZVF□M471 | 8/20 μ s | 20 A | | | | | | | | | | | | | | | | | | | | | | | | | | | | | | | | | | | |
| VF□T | ERZVF□T820 to ERZVF□T271 | 8/20 μ s | 14 A | | | | | | | | | | | | | | | | | | | | | | | | | | | | | | | | | | | |
| | CF | ERZCF□MK220 to ERZCF□MK680 | 2 ms | 0.45 A | | | | | | | | | | | | | | | | | | | | | | | | | | | | | | | | | | |
| | | ERZCF□MK820 to ERZCF□MK471 | 8/20 μ s | 14 A | | | | | | | | | | | | | | | | | | | | | | | | | | | | | | | | | | |
| SF | ERZSF□MK220 to ERZSF□MK680 | 8/20 μ s | 12 A | | | | | | | | | | | | | | | | | | | | | | | | | | | | | | | | | | | |
| | ERZSF□MK820 to ERZSF□MK271 | 8/20 μ s | 35 A | | | | | | | | | | | | | | | | | | | | | | | | | | | | | | | | | | | |
| | ERZSF□MK331 to ERZSF□MK471 | 8/20 μ s | 28 A | | | | | | | | | | | | | | | | | | | | | | | | | | | | | | | | | | | |

Design, Specifications are subject to change without notice. Ask factory for technical specifications before purchase and/or use. Whenever a doubt about safety arises from this product, please inform us immediately for technical consultation without fail.