

CM150DY-12E

Powerex, Inc., 200 Hillis Street, Youngwood, Pennsylvania 15697-1800 (412) 925-7272
 Powerex, Europe, S.A. 428 Avenue G. Durand, BP107, 72003 Le Mans, France (43) 41.14.14

Dual IGBTMOD™ E-Series Module 150 Amperes/600 Volts

POWEREX INC

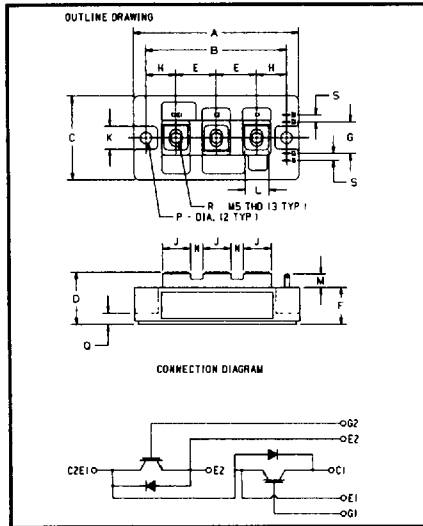

CM150DY-12E
 Outline Drawing

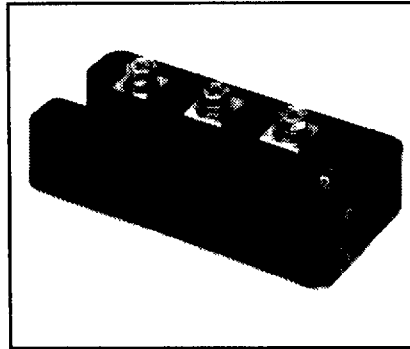

CM150DY-12E
 Dual IGBTMOD™ E-Series Module
 150 Amperes/600 Volts

Description:

Powerex IGBTMOD™ Modules are designed for use in switching applications. Each module consists of two IGBT Transistors in a half-bridge configuration with each transistor having a reverse-connected super-fast recovery free-wheel diode. All components and interconnects are isolated from the heat sinking baseplate, offering simplified system assembly and thermal management.

Features:

- Low Drive Power
- Low $V_{CE(sat)}$
- Discrete Super-Fast Recovery (150ns) Free-Wheel Diode
- High Frequency Operation (15-20kHz)
- Isolated Baseplate for Easy Heat Sinking

Applications:

- AC Motor Control
- Motion/Servo Control
- UPS
- Welding Power Supplies
- Laser Power Supplies

Ordering Information:

Example: Select the complete part module number you desire from the table below

-i.e. CM150DY-12E is a 600V (V_{CES}), 150 Ampere Dual IGBTMOD™ Power Module.

Dimensions	Inches	Millimeters
A	3.70	94.0
B	3.150±0.01	80.0±0.25
C	1.89	48.0
D	1.18 Max.	30.0 Max.
E	0.90	23.0
F	0.83	21.2
G	0.71	18.0
H	0.67	17.0
J	0.63	16.0
K	0.51	13.0
L	0.47	12.0
M	0.30	7.5
N	0.28	7.0
P	0.256 Dia.	Dia. 6.5
Q	0.26	6.5
R	M5 Metric	M5
S	0.16	4.0

Type	Current Rating Amperes	V_{CES} Volts (x 50)
CM	150	12

Powerex, Inc., 200 Hillis Street, Youngwood, Pennsylvania 15697-1800 (412) 925-7272
 Powerex, Europe, S.A. 428 Avenue G. Durand, BP107, 72003 Le Mans, France (43) 41.14.14

CM150DY-12E
Dual IGBTMOD™ E-Series Module
 150 Amperes/600 Volts

Absolute Maximum Ratings, $T_j = 25\text{ }^\circ\text{C}$ unless otherwise specified

Ratings	Symbol	CM150DY-12E	Units
Junction Temperature	T_j	-40 to 150	$^\circ\text{C}$
Storage Temperature	T_{stg}	-40 to 125	$^\circ\text{C}$
Collector-Emitter Voltage (G-E SHORT)	V_{CES}	600	Volts
Gate-Emitter Voltage	V_{GES}	± 20	Volts
Collector Current	I_C	150	Amperes
Peak Collector Current	I_{CM}	300*	Amperes
Diode Forward Current	I_{FM}	150	Amperes
Diode Forward Surge Current	I_{FM}	300*	Amperes
Power Dissipation	P_d	600	Watts
Max. Mounting Torque M5 Terminal Screws	-	17	in-lb
Max. Mounting Torque M6 Mounting Screws	-	26	in-lb
Module Weight (Typical)	-	270	Grams
V Isolation	V_{RMS}	2500	Volts

* Pulse width and repetition rate should be such that device junction temperature does not exceed the device rating

Static Electrical Characteristics, $T_j = 25\text{ }^\circ\text{C}$ unless otherwise specified

Characteristics	Symbol	Test Conditions	Min.	Typ.	Max.	Units
Collector-Cutoff Current	I_{CES}	$V_{CE} = V_{CES}, V_{GE} = 0V$	-	-	1.0	mA
Gate Leakage Current	I_{GES}	$V_{GE} = V_{GES}, V_{CE} = 0V$	-	-	0.5	μA
Gate-Emitter Threshold Voltage	$V_{GE(th)}$	$I_C = 15\text{mA}, V_{CE} = 10V$	3.0	4.0	6.0	Volts
Collector-Emitter Saturation Voltage	$V_{CE(sat)}$	$I_C = 150A, V_{GE} = 15V$	-	2.7	3.5**	Volts
		$I_C = 150A, V_{GE} = 15V, T_j = 150^\circ\text{C}$	-	2.7	-	Volts
Total Gate Charge	Q_G	$V_{CC} = 300V, I_C = 150A, V_{GS} = 15V$	-	750	-	nC
Diode Forward Voltage	V_{FM}	$I_C = 150A, V_{GS} = 0V$	-	-	2.5	Volts

** Pulse width and repetition rate should be such that device junction temperature rise is negligible

Dynamic Electrical Characteristics, $T_j = 25\text{ }^\circ\text{C}$ unless otherwise specified

Characteristics	Symbol	Test Conditions	Min.	Typ.	Max.	Units	
Input Capacitance	C_{ies}		-	-	30	nF	
Output Capacitance	C_{oes}	$V_{GE} = 0V, V_{CE} = 10V, f = 1\text{MHz}$	-	-	9	nF	
Reverse Transfer Capacitance	C_{res}		-	-	6	nF	
Resistive	Turn-on Delay Time	$V_{CC} = 300V, I_C = 150A,$ $V_{GE1} = V_{GE2} = 15V, R_G = 4.2\Omega$	-	-	400	ns	
Load	Rise Time		t_r	-	-	700	ns
Switch Times	Turn-off Delay Time		$t_{d(off)}$	-	-	600	ns
	Fall Time		t_f	-	-	350	ns
Diode Reverse Recovery Time	t_{rr}	$I_E = 150A, di_E/dt = -300A/\mu\text{s}$	-	-	200	ns	
Diode Reverse Recovery Charge	Q_{rr}	$I_E = 150A, di_E/dt = -300A/\mu\text{s}$	-	2.0	-	μC	

Thermal and Mechanical Characteristics, $T_j = 25\text{ }^\circ\text{C}$ unless otherwise specified

Characteristics	Symbol	Test Conditions	Min.	Typ.	Max.	Units
Thermal Resistance, Junction to Case	$R_{th(j-c)}$	Per IGBT	-	-	0.21	$^\circ\text{C/W}$
Thermal Resistance, Junction to Case	$R_{th(j-c)}$	Per Free Wheel Diode	-	-	0.47	$^\circ\text{C/W}$
Contact Thermal Resistance	$R_{th(c-f)}$	Per Half Module	-	-	0.13	$^\circ\text{C/W}$



POWEREX INC

Powerex, Inc., 200 Hillis Street, Youngwood, Pennsylvania 15697-1800 (412) 925-7272
 Powerex, Europe, S.A. 428 Avenue G. Durand, BP107, 72003 Le Mans, France (43) 41.14.14

CM150DY-12E
Dual IGBTMOD™ E-Series Module
 150 Amperes/600 Volts

OUTPUT CHARACTERISTICS (TYPICAL)

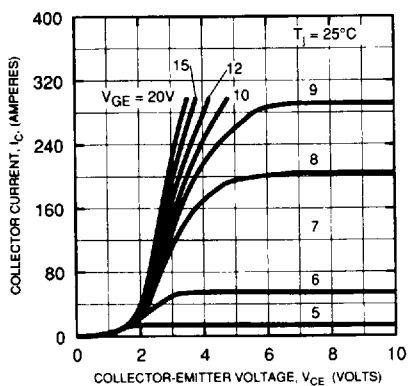

TRANSFER CHARACTERISTICS (TYPICAL)

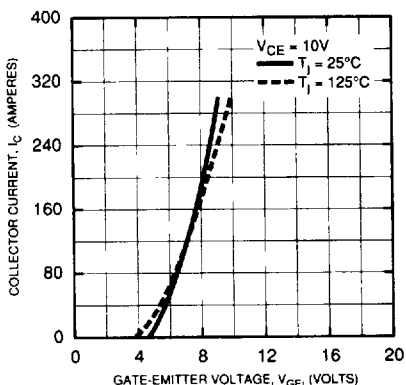

COLLECTOR-EMITTER SATURATION VOLTAGE CHARACTERISTICS (TYPICAL)

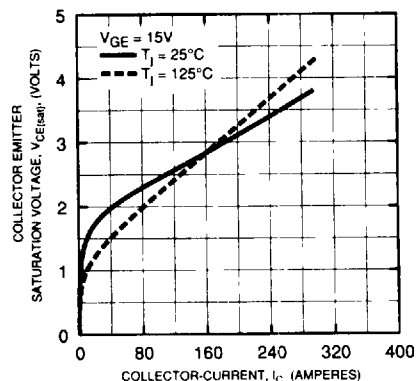

COLLECTOR-EMITTER SATURATION VOLTAGE CHARACTERISTICS (TYPICAL)

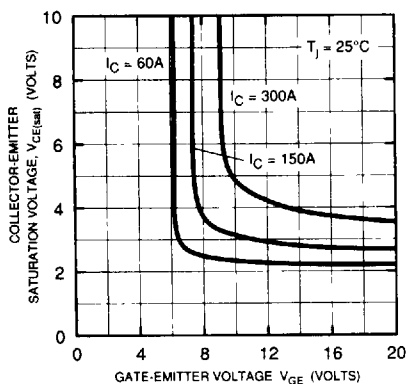

FREE-WHEEL DIODE FORWARD CHARACTERISTICS (TYPICAL)

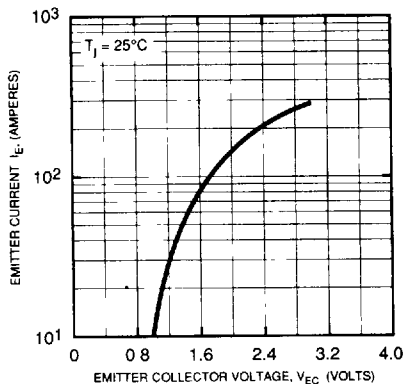

CAPACITANCE VS. V_CE (TYPICAL)

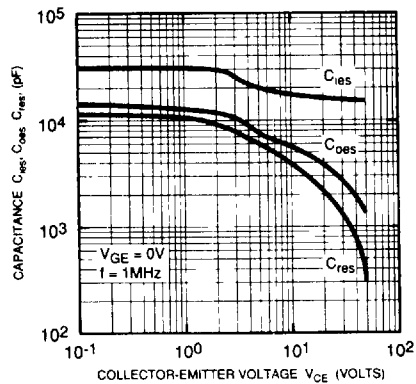

HALF-BRIDGE SWITCHING CHARACTERISTICS (TYPICAL)

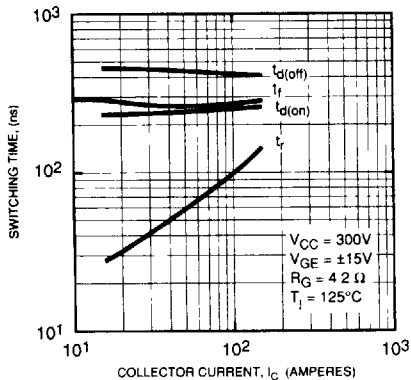

REVERSE RECOVERY CHARACTERISTICS (TYPICAL)

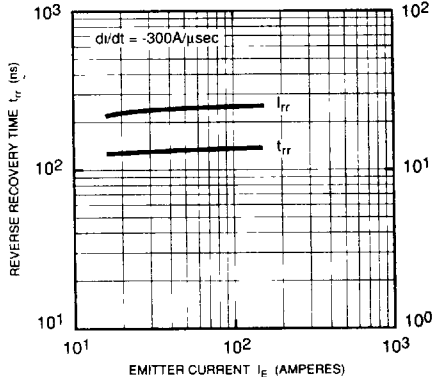

GATE CHARGE, V_GE

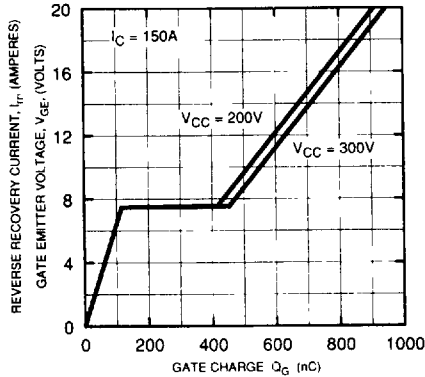



POWEREX INC

Powerex, Inc., 200 Hillis Street, Youngwood, Pennsylvania 15697-1800 (412) 925-7272
 Powerex, Europe, S.A. 428 Avenue G. Durand, BP107, 72003 Le Mans, France (43) 41.14.14

CM150DY-12E
 Dual IGBTMOD™ E-Series Module
 150 Amperes/600 Volts

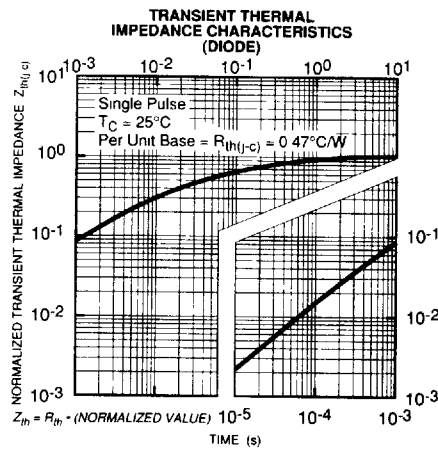
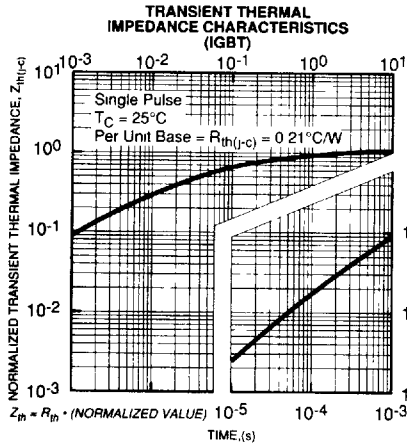

SWITCHING TIME TEST CIRCUITS & WAVEFORMS

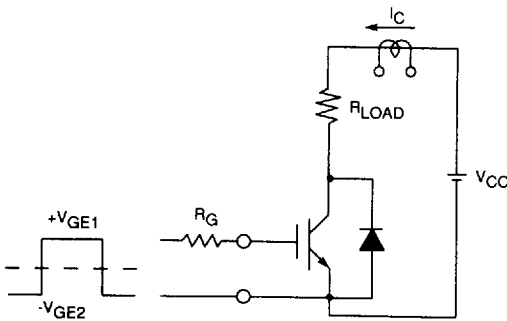

RESISTANCE LOAD SWITCHING TEST CIRCUIT

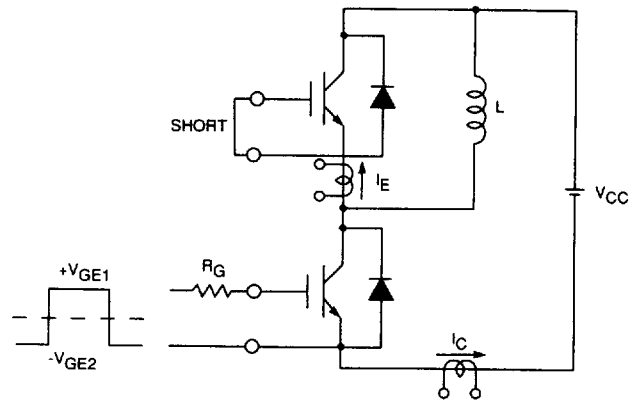

HALF-BRIDGE SWITCHING TEST CIRCUIT

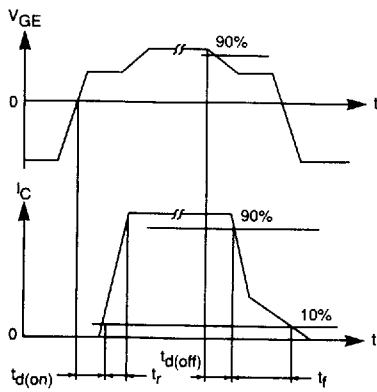

SWITCHING TIME TEST WAVEFORMS

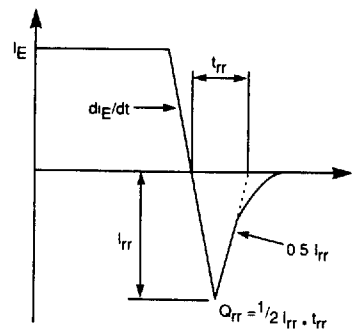

t_{rr}, Q_{rr} WAVEFORMS