



BYW51/F/G/FP/R-200

HIGH EFFICIENCY FAST RECOVERY RECTIFIER DIODES

MAIN PRODUCT CHARACTERISTICS

$I_{F(AV)}$	2 x 10 A
V_{RRM}	200 V
T_j (max)	150 °C
V_F (max)	0.85 V
t_{rr} (max)	25 ns

FEATURES AND BENEFITS

- SUITED FOR SMPS
- VERY LOW FORWARD LOSSES
- NEGLIGIBLE SWITCHING LOSSES
- HIGH SURGE CURRENT CAPABILITY
- INSULATED PACKAGES (ISOWATT220AB / TO-220FP) :
Insulation voltage = 2000 V DC
Capacitance = 12 pF

DESCRIPTION

Dual center tap rectifier suited for Switched Mode Power Supplies and high frequency DC to DC converters.

Packaged in TO-220AB, ISOWATT220AB, TO-220FP, D²PAK or I²PAK, this device is intended for use in low voltage, high frequency inverters, free wheeling and polarity protection applications.

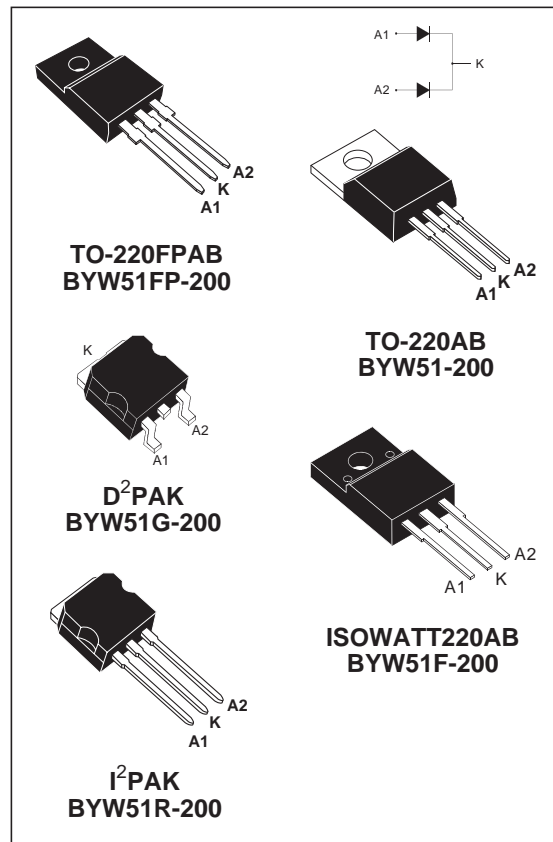

ABSOLUTE RATINGS (limiting values, per diode)

Symbol	Parameter		Value	Unit		
V_{RRM}	Repetitive peak reverse voltage		200	V		
$I_{F(RMS)}$	RMS forward current		20	A		
$I_{F(AV)}$	Average forward current $\delta = 0.5$	TO-220AB / D ² PAK I ² PAK	T _c =120°C	Per diode	10	A
				Per device	20	
		ISOWATT220AB	T _c =95°C	Per diode	10	
				Per device	20	
		TO-220FPAB	T _c =85°C	Per diode	10	
				Per device	20	
I_{FSM}	Surge non repetitive forward current		tp=10ms sinusoidal	100	A	
T_{stg}	Storage temperature range			- 65 to + 150	°C	
T_j	Maximum operating junction temperature			150	°C	

BYW51/F/G/FP/R-200

THERMAL RESISTANCES

Symbol	Parameter		Value	Unit	
$R_{th(j-c)}$	Junction to case	TO-220AB / D ² PAK / I ² PAK	Per diode	2.5	°C/W
			Total	1.4	
		ISOWATT220AB	Per diode	5.1	
			Total	4.05	
		TO-220FPAB	Per diode	5.7	
			Total	4.6	
$R_{th(c)}$	Coupling	TO-220AB / D ² PAK / I ² PAK	0.25	°C/W	
		ISOWATT220AB	3.0		
		TO-220FPAB	3.5		

When diodes 1 and 2 are used simultaneously :

$$\Delta T_c (\text{diode } 1) = P(\text{diode } 1) \times R_{th(j-c)} (\text{Per diode}) + P(\text{diode } 2) \times R_{th(c)}$$

STATIC ELECTRICAL CHARACTERISTICS (Per diode)

Symbol	Parameter	Test Conditions		Min.	Typ.	Max.	Unit
I_R^*	Reverse leakage current	$T_j = 25^\circ\text{C}$	$V_R = V_{RRM}$			15	μA
		$T_j = 100^\circ\text{C}$				1	mA
V_F^{**}	Forward voltage drop	$T_j = 125^\circ\text{C}$	$I_F = 8 \text{ A}$			0.85	V
		$T_j = 125^\circ\text{C}$	$I_F = 16 \text{ A}$			1.05	
		$T_j = 25^\circ\text{C}$	$I_F = 16 \text{ A}$			1.15	

Pulse test : * $t_p = 5 \text{ ms}$, $\delta < 2 \%$

** $t_p = 380 \mu\text{s}$, $\delta < 2 \%$

To evaluate the conduction losses use the following equation :

$$P = 0.65 \times I_{F(AV)} + 0.025 \times I_F^2(\text{RMS})$$

RECOVERY CHARACTERISTICS

Symbol	Test Conditions			Typ.	Max.	Unit
trr	$T_j = 25^\circ\text{C}$	$I_F = 0.5 \text{ A}$ $I_R = 1 \text{ A}$	$I_{rr} = 0.25 \text{ A}$		25	ns
		$I_F = 1 \text{ A}$ $V_R = 30 \text{ V}$	$di_F/dt = -50 \text{ A}/\mu\text{s}$		35	
tfr	$T_j = 25^\circ\text{C}$	$I_F = 1 \text{ A}$ $V_{FR} = 1.1 \times V_F \text{ max}$	$di_F/dt = -50 \text{ A}/\mu\text{s}$	15		ns
V_{FP}	$T_j = 25^\circ\text{C}$	$I_F = 1 \text{ A}$	$di_F/dt = -50 \text{ A}/\mu\text{s}$	2		V

Fig. 1: Average forward power dissipation versus average forward current (per diode).

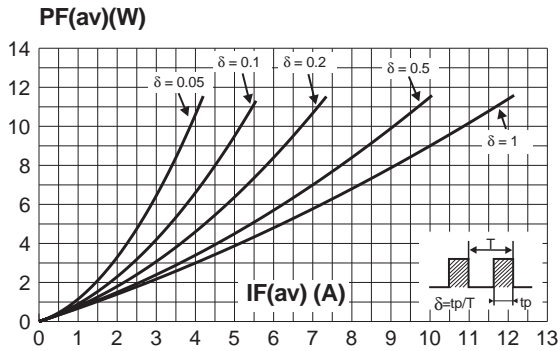

Fig. 2: Peak current versus form factor (per diode).

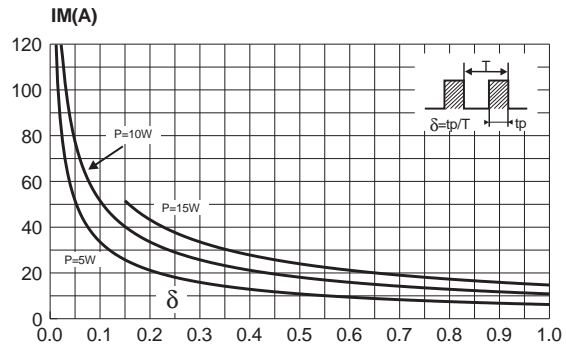

Fig. 3-1: Average forward current versus ambient temperature ($\delta = 0.5$, D²PAK, TO-220AB).

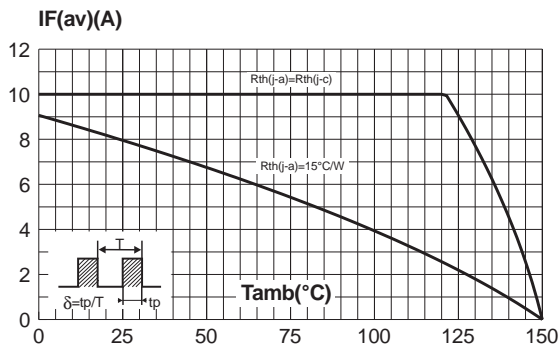

Fig. 3-2: Average forward current versus ambient temperature ($\delta = 0.5$, ISOWATT220AB, TO-220FPAB).

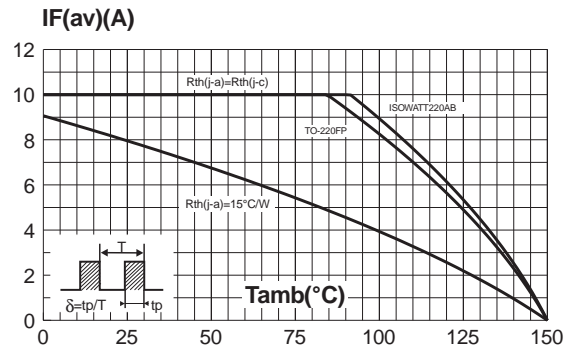

Fig. 4-1: Non repetitive surge peak forward current versus overload duration (D²PAK, TO-220AB).

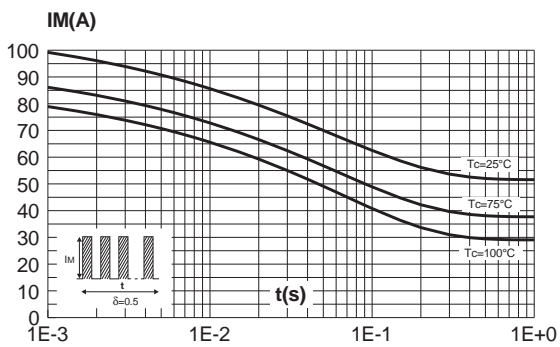
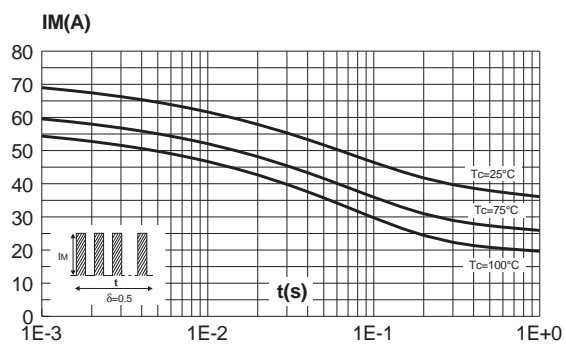

Fig. 4-2: Non repetitive surge peak forward current versus overload duration (ISOWATT220AB).



BYW51/F/G/FP/R-200

Fig. 4-3: Non repetitive surge peak forward current versus overload duration (TO-220FPAB).

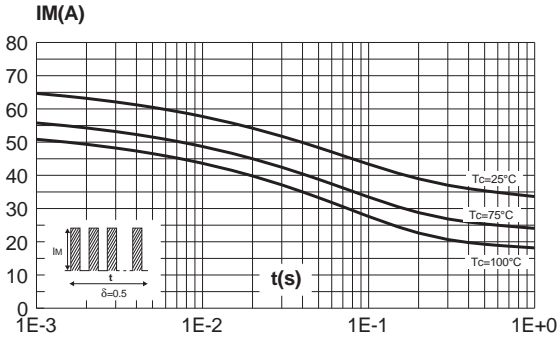

Fig. 5-2: Relative variation of thermal impedance junction to case versus pulse duration (ISOWATT220AB, TO-220FPAB).

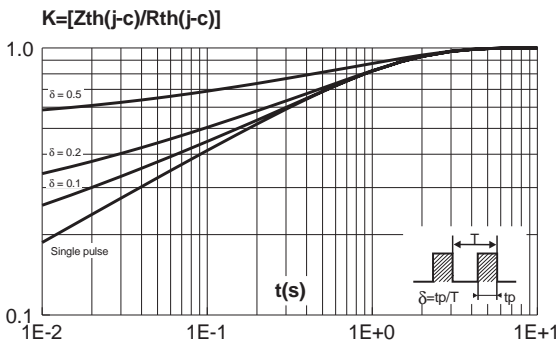

Fig. 7: Junction capacitance versus reverse voltage applied (typical values, per diode).

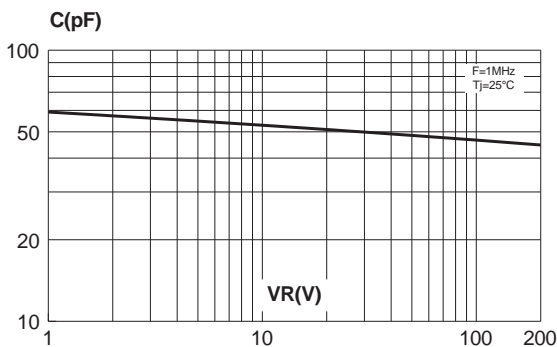

Fig. 5-1: Relative variation of thermal impedance junction to case versus pulse duration (D²PAK, TO-220AB).

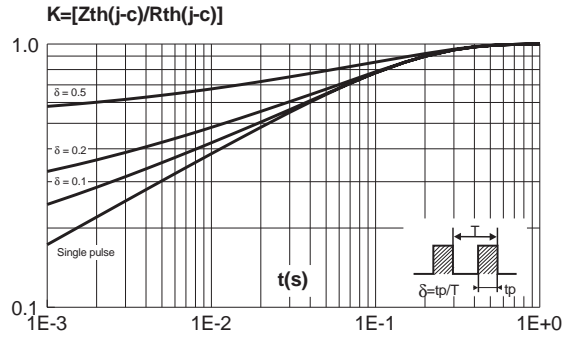

Fig. 6: Forward voltage drop versus forward current (maximum values, per diode).

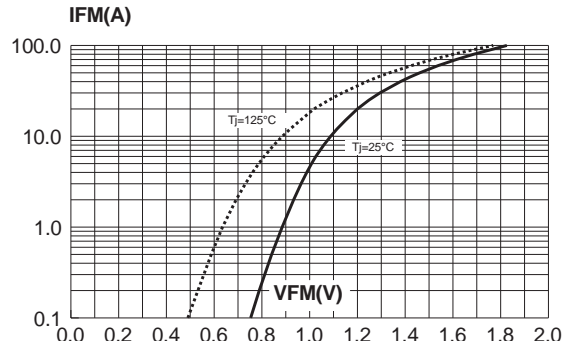

Fig. 8: Reverse recovery charges versus dIF/dt (per diode).

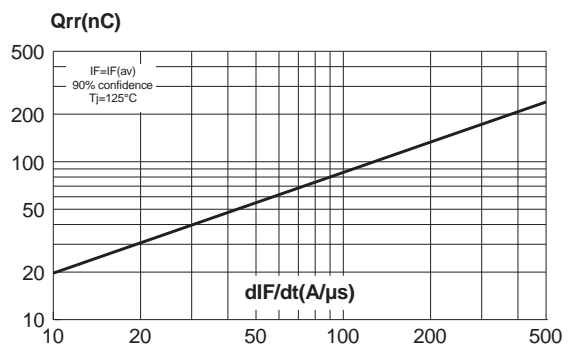

Fig. 9: Peak reverse recovery current versus dI_F/dt (per diode).

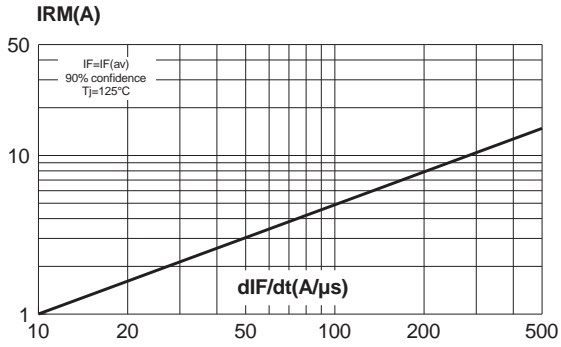

Fig. 10: Dynamic parameters versus junction temperature.

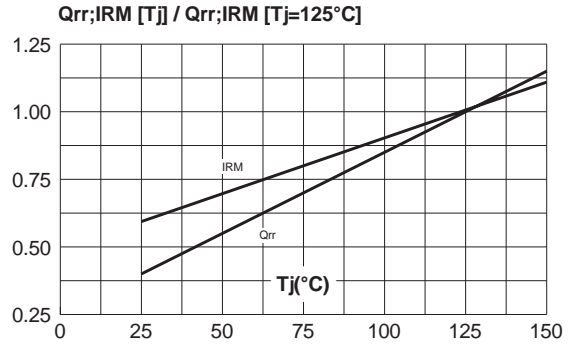
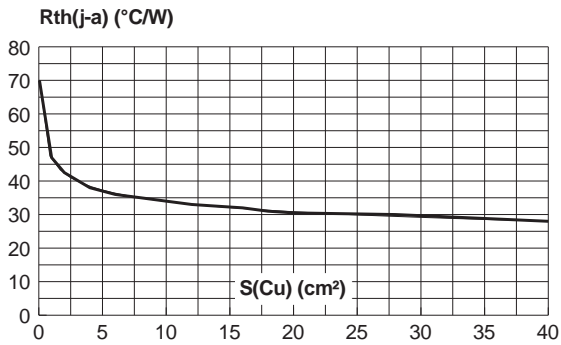
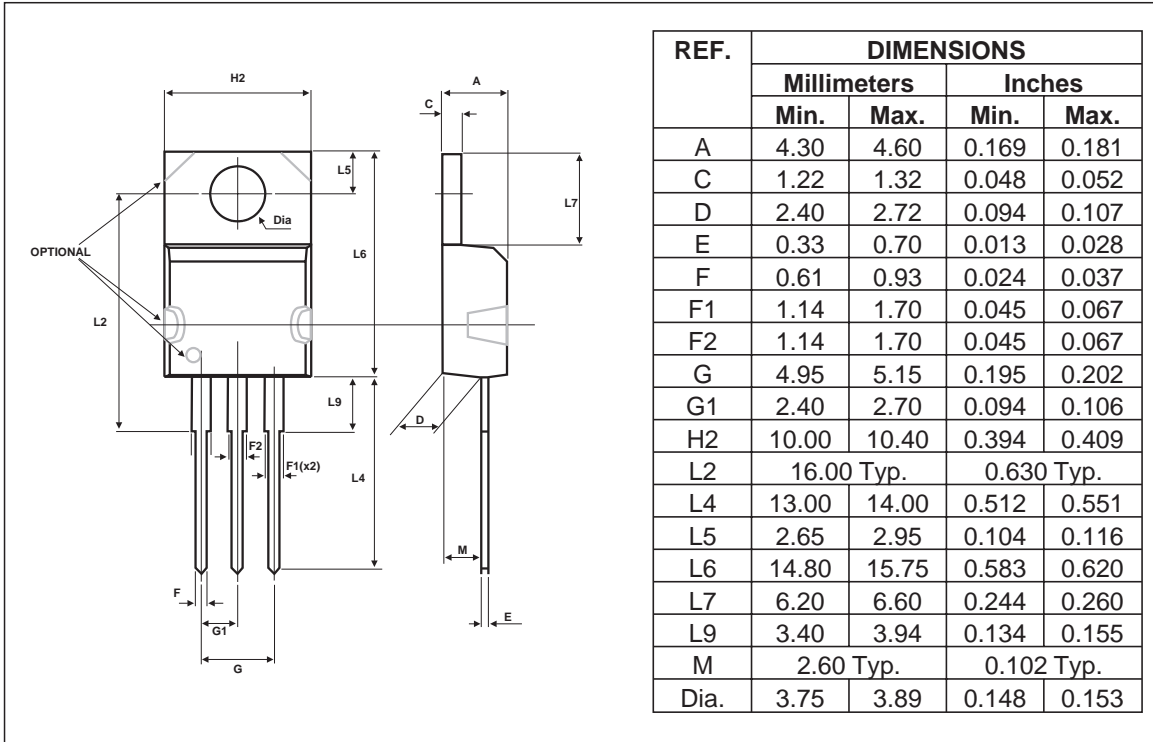

Fig. 11: Thermal resistance junction to ambient versus copper surface under tab (Epoxy printed circuit board FR4, copper thickness: 35 μ m) (D²PAK).



PACKAGE MECHANICAL DATA
TO-220AB (JEDEC compatible)



PACKAGE MECHANICAL DATA
I²PAK

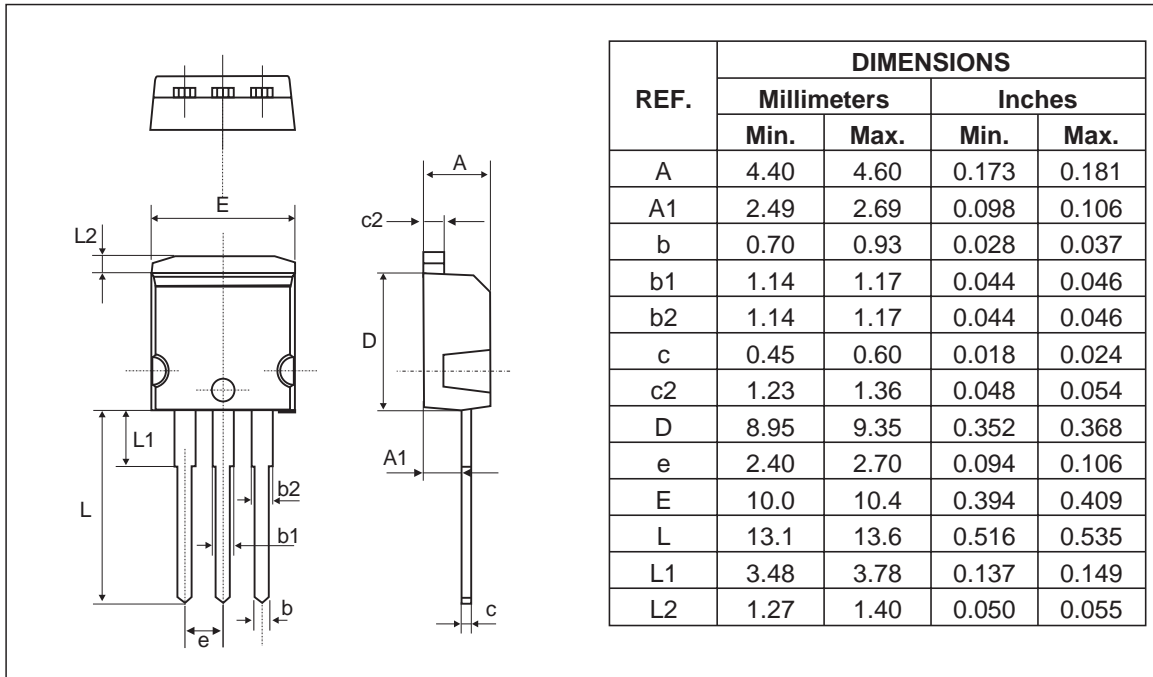

BYW51/F/G/FP/R-200

PACKAGE MECHANICAL DATA
D²PAK

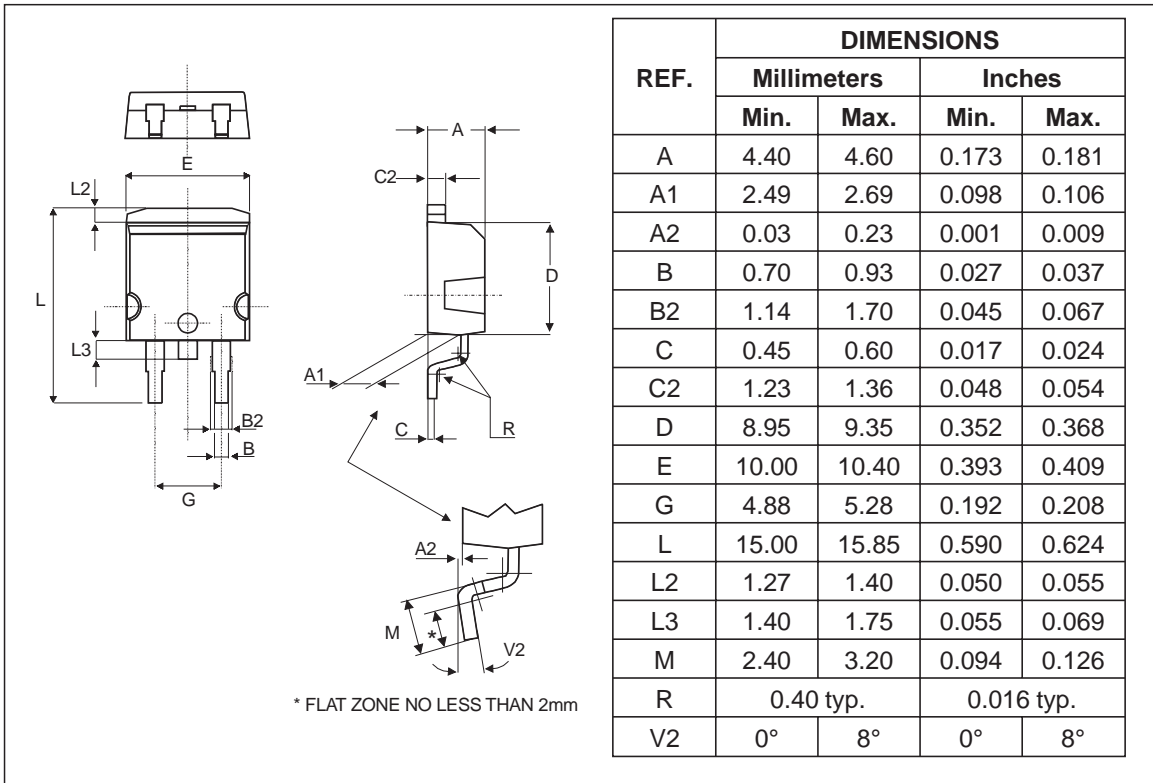

FOOT PRINT (in millimeters)
D²PAK

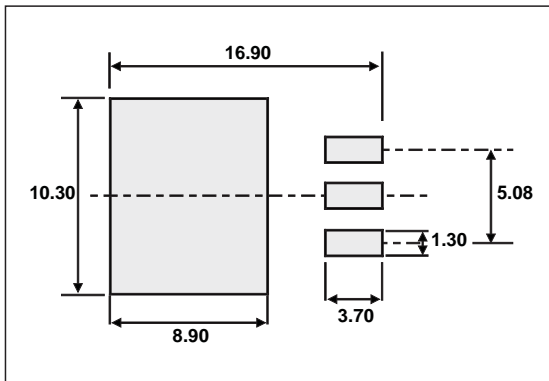

PACKAGE MECHANICAL DATA
TO-220FPAB

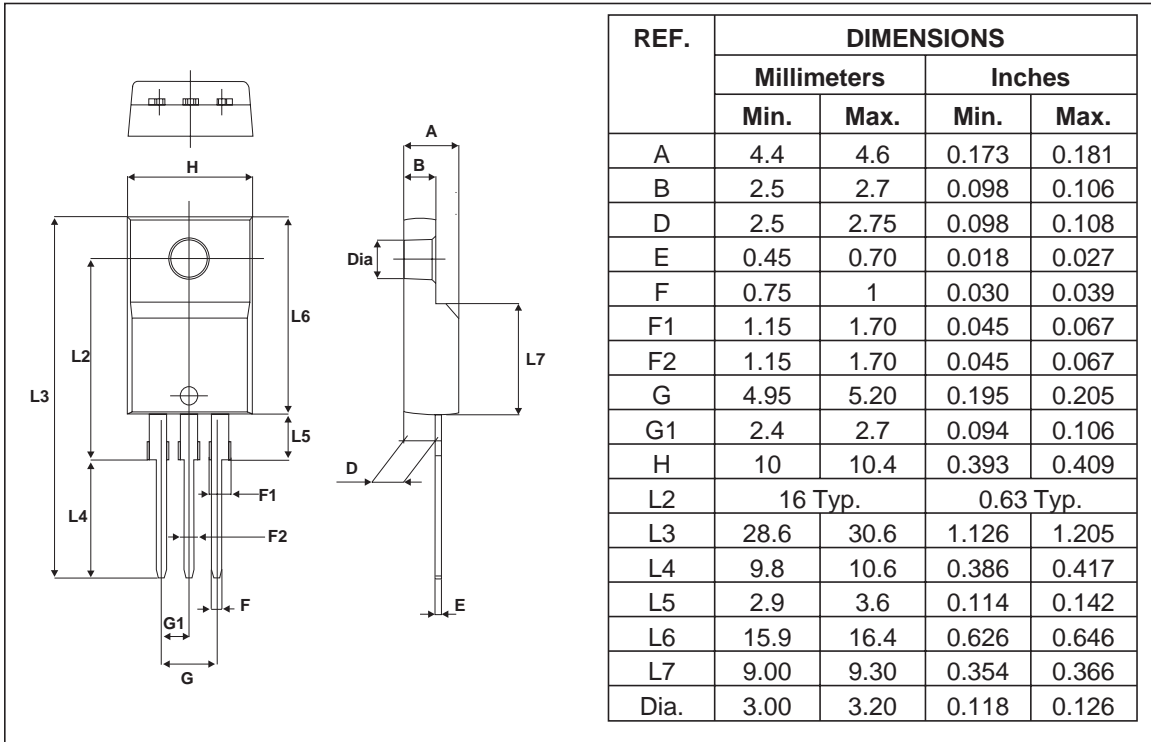

PACKAGE MECHANICAL DATA
ISOWATT220AB (JEDEC compatible)

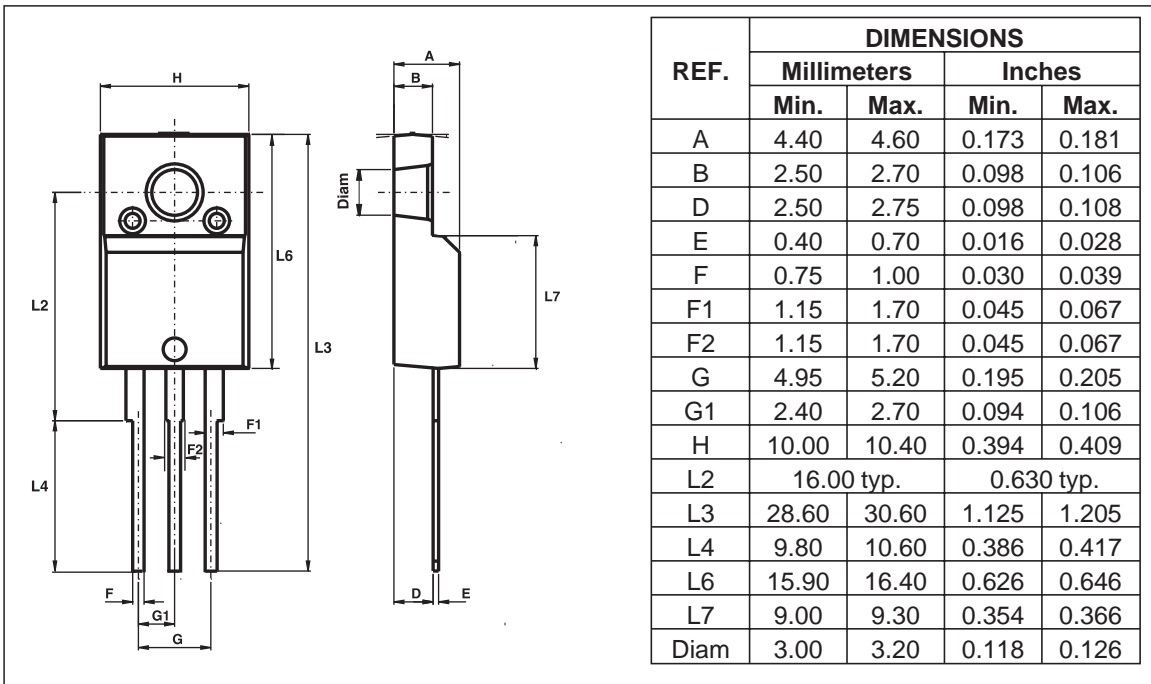

Ordering code	Marking	Package	Weight	Base qty	Delivery mode
BYW51-200	BYW51-200	TO220AB	2.2 g.	50	Tube
BYW51F-200	BYW51F-200	ISOWATT220AB	2.08 g.	50	Tube
BYW51G-200	BYW51G-200	D ² PAK	1.48 g.	50	Tube
BYW51FP-200	BYW51FP-200	TO-220FPAB	2g	50	Tube
BYW51R-200	BYW51R-200	I ² PAK	1.49 g	50	Tube

- Recommended torque value (TO-220AB): 0.8 N.m.
- Maximum torque value (TO-220AB): 1.0 N.m.
- Recommended torque value (ISOWATT220AB / TO-220FPAB): 0.55 N.m.
- Maximum torque value (ISOWATT220AB / TO-220FPAB): 0.70 N.m.
- Epoxy meets UL94,V0

Information furnished is believed to be accurate and reliable. However, STMicroelectronics assumes no responsibility for the consequences of use of such information nor for any infringement of patents or other rights of third parties which may result from its use. No license is granted by implication or otherwise under any patent or patent rights of STMicroelectronics. Specifications mentioned in this publication are subject to change without notice. This publication supersedes and replaces all information previously supplied. STMicroelectronics products are not authorized for use as critical components in life support devices or systems without express written approval of STMicroelectronics.

The ST logo is a registered trademark of STMicroelectronics

© 2002 STMicroelectronics - Printed in Italy - All rights reserved.

STMicroelectronics GROUP OF COMPANIES

Australia - Brazil - Canada - China - Finland - France - Germany
 Hong Kong - India - Israel - Italy - Japan - Malaysia - Malta - Morocco - Singapore
 Spain - Sweden - Switzerland - United Kingdom - United States.

<http://www.st.com>

