

Features

- Industry Standard Architecture
 - Low-cost Easy-to-use Software Tools
- High-speed, Electrically-erasable Programmable Logic Devices
 - 7.5 ns Maximum Pin-to-pin Delay
- Several Power Saving Options

Device	I _{CC} , Standby	I _{CC} , Active
ATF22V10B	85 mA	90 mA
ATF22V10BQ	35 mA	40 mA
ATF22V10BQL	5 mA	20 mA

- CMOS and TTL Compatible Inputs and Outputs
 - Input and I/O Pull-up Resistors
- Advanced Flash Technology
 - Reprogrammable
 - 100% Tested
- High-reliability CMOS Process
 - 20-year Data Retention
 - 100 Erase/Write Cycles
 - 2,000V ESD Protection
 - 200 mA Latchup Immunity
- Full Military, Commercial, and Industrial Temperature Ranges
- Dual-in-line and Surface Mount Packages in Standard Pinouts
- PCI Compliant

Logic Diagram

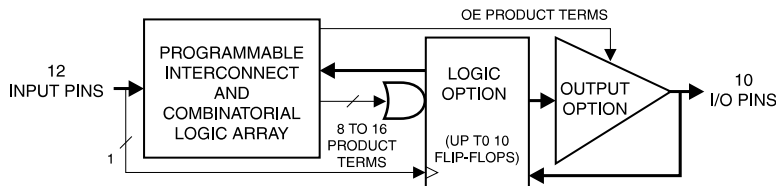

Pin Configurations

All Pinouts Top View

Pin Name	Function
CLK	Clock
IN	Logic Inputs
I/O	Bidirectional Buffers
*	No Internal Connection
V _{CC}	+5V Supply

TSSOP

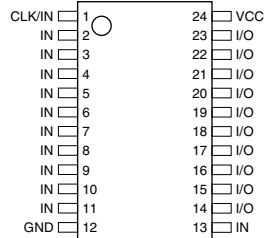

DIP/SOIC

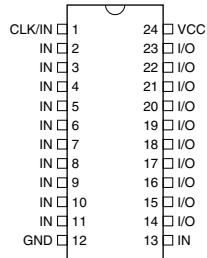

LCC/PLCC

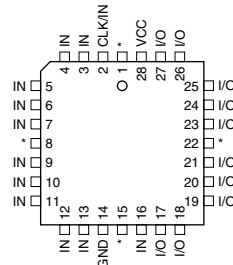

High-performance
EE PLD

ATF22V10B
ATF22V10BQ
ATV22V10BQL

Rev. 0250K-03/01



Description

The ATF22V10B is a high-performance CMOS (electrically-erasable) programmable logic device (PLD) which utilizes Atmel's proven electrically-erasable Flash memory technology. Speeds down to 7.5 ns and power dissipation as low as 10 mA are offered. All speed ranges are specified over the full $5V \pm 10\%$ range for military and industrial

temperature ranges, and $5V \pm 5\%$ for commercial temperature ranges.

Several low-power options allow selection of the best solution for various types of power-limited applications. Each of these options significantly reduces total system power and enhances system reliability.

Absolute Maximum Ratings*

Temperature Under Bias.....	-55°C to +125°C
Storage Temperature.....	-65°C to +150°C
Voltage on Any Pin with Respect to Ground	-2.0V to +7.0V ⁽¹⁾
Voltage on Input Pins with Respect to Ground During Programming.....	-2.0V to +14.0V ⁽¹⁾
Programming Voltage with Respect to Ground	-2.0V to +14.0V ⁽¹⁾

*NOTICE: Stresses beyond those listed under "Absolute Maximum Ratings" may cause permanent damage to the device. This is a stress rating only and functional operation of the device at these or any other conditions beyond those indicated in the operational sections of this specification is not implied. Exposure to absolute maximum rating conditions for extended periods may affect device reliability.

Note: 1. Minimum voltage is -0.6V DC, which may undershoot to -2.0V for pulses of less than 20 ns. Maximum output pin voltage is $V_{CC} + 0.75V$ DC, which may overshoot to 7.0V for pulses of less than 20 ns.

DC and AC Operating Conditions

	Commercial	Industrial	Military
Operating Temperature	0°C - 70°C (Ambient)	-40°C - 85°C (Ambient)	-55°C - 125°C (Case)
V_{CC} Power Supply	$5V \pm 5\%$	$5V \pm 10\%$	$5V \pm 10\%$

Note: 1. The shaded devices are obsolete.

DC Characteristics

Symbol	Parameter	Condition	Min	Typ	Max	Units	
I_{IL}	Input or I/O Low Leakage Current	$0 \leq V_{IN} \leq V_{IL} \text{ (Max)}$		-35	-100	μA	
I_{IH}	Input or I/O High Leakage Current	$3.5 \leq V_{IN} \leq V_{CC}$			10	μA	
I_{CC}	Power Supply Current, Standby	$V_{CC} = \text{Max,}$ $V_{IN} = \text{Max,}$ Outputs Open	B-7	Com.	85	120	mA
				Ind., Mil.	85	140	mA
I_{CC}	Power Supply Current, Standby	$V_{CC} = \text{Max,}$ $V_{IN} = \text{Max,}$ Outputs Open	B-10	Com./Ind.	85/85	120/140	mA
				Mil.	85	140	mA
			B-15	Com./Ind.	65/65	90/115	mA
				Mil.	65	115	mA
			B-25	Com.	65	90	mA
				Ind., Mil.	65	115	mA
			BQ-15	Com.	35	55	mA
			BQL-20, -25	Com.	5	10	mA
Ind., Mil.	5	15		mA			
I_{CC2}	Clocked Power Supply Current	$V_{CC} = \text{Max,}$ Outputs Open, $f = 15 \text{ MHz}$	B-7	Com.	90	120	mA
				Mil., Ind.	90	145	mA
			B-10	Com./Ind.	90/90	120/145	mA
				Mil.	90	145	mA
			B-15	Com./Ind.	65/65	90/120	mA
				Mil.	65	120	mA
			B-25	Com.	65	90	mA
				Ind., Mil.	65	120	mA
			BQ-15	Com.	40	60	mA
			BQL-20, -25	Com.	20	50	mA
Ind., Mil.	20	70		mA			
$I_{OS}^{(1)}$	Output Short Circuit Current	$V_{OUT} = 0.5\text{V}$			-130	mA	
V_{IL}	Input Low Voltage		-0.5		0.8	V	
V_{IH}	Input High Voltage		2.0		$V_{CC} + 0.75$	V	
V_{OL}	Output Low Voltage	$V_{IN} = V_{IH} \text{ or } V_{IL},$ $V_{CC} = \text{Min}$	$I_{OL} = 16 \text{ mA}$	Com., Ind.		0.5	V
			$I_{OL} = 12 \text{ mA}$	Mil.		0.5	V
V_{OH}	Output High Voltage	$V_{IN} = V_{IH} \text{ or } V_{IL},$ $V_{CC} = \text{Min}$	$I_{OH} = -4.0 \text{ mA}$	2.4		V	

Notes: 1. Not more than one output at a time should be shorted. Duration of short circuit test should not exceed 30 sec.
2. The shaded devices are obsolete.

AC Waveforms⁽¹⁾

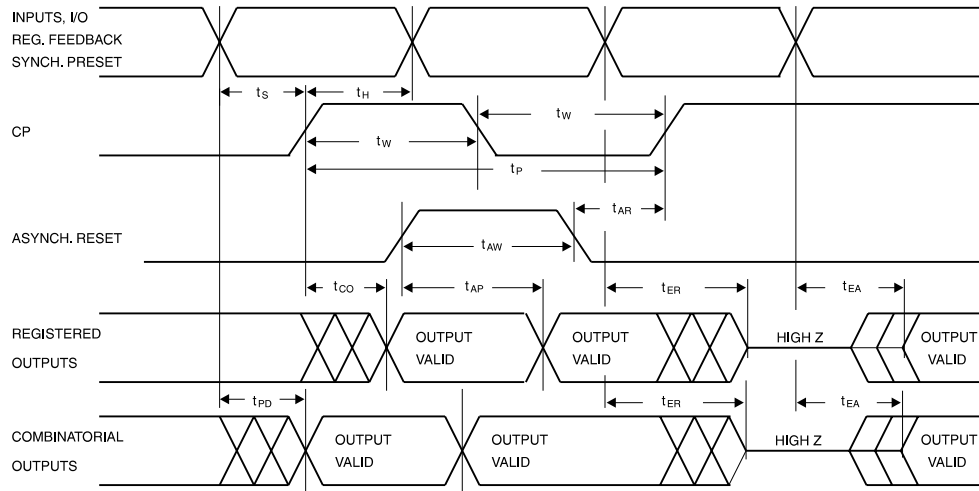

Note: 1. Timing measurement reference is 1.5V. Input AC driving levels are 0.0V and 3.0V, unless otherwise specified.

AC Characteristics⁽¹⁾

Symbol	Parameter	-7		-10		-15		-20		-25		Units
		Min	Max	Min	Max	Min	Max	Min	Max	Min	Max	
t_{PD}	Input or Feedback to Combinatorial Output	3	7.5	3	10	3	15	3	20	3	25	ns
t_{CO}	Clock to Output	2	4.5 ⁽²⁾	2	6.5	2	8	2	12	2	15	ns
t_{CF}	Clock to Feedback		2.5		2.5		2.5		8		13	ns
t_S	Input or Feedback Setup Time	3.5		4.5		10			14	15		ns
t_H	Hold Time	0		0		0		0		0		ns
f_{MAX}	External Feedback $1/(t_S + t_{CO})$	125 ⁽³⁾		90		55.5		38.5		33.3		MHz
	Internal Feedback $1/(t_S + t_{CF})$	166		142		69		45.5		40		MHz
	No Feedback $1/(t_{WH} + t_{WL})$	166		142		83.3				38.5		MHz
t_W	Clock Width (t_{WL} and t_{WH})	3		3.5		6		10		13		ns
t_{EA}	Input or I/O to Output Enable	3	7.5	3	10	3	15	3	20	3	25	ns
t_{ER}	Input or I/O to Output Disable	3	7.5	3	9	3	15	3	20	3	25	ns
t_{AP}	Input or I/O to Asynchronous Reset of Register	3	10	3	12	3	20	3	22	3	25	ns
t_{AW}	Asynchronous Reset Width	7		8		15		20		25		ns
t_{AR}	Asynchronous Reset Recovery Time	5		6		10		20		25		ns
t_{SP}	Setup Time, Synchronous Preset	4.5		6		10		14		15		ns
t_{SPR}	Synchronous Preset to Clock Recovery Time	5		8		10		14		15		ns

- Notes: 1. See ordering information for valid part numbers.
 2. 5.5 ns for DIP package devices.
 3. 111 MHz for DIP package devices.
 4. The shaded devices are obsolete.

Input Test Waveforms and Measurement Levels

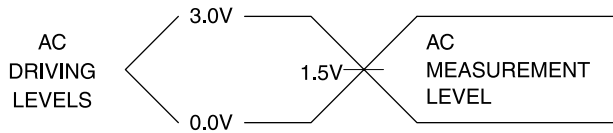

$t_R, t_F < 3 \text{ ns}$

Output Test Loads

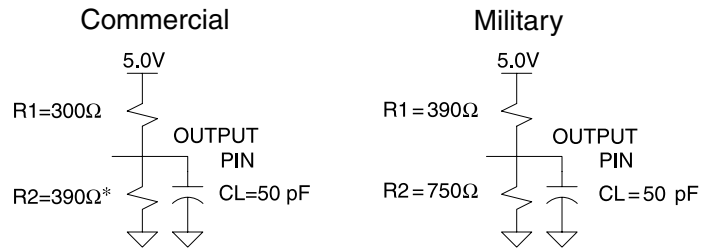

* All except -7 which is R2 = 300Ω

Pin Capacitance

$f = 1 \text{ MHz}, T = 25^\circ\text{C}^{(1)}$

	Typ	Max	Units	Conditions
C_{IN}	5	8	pF	$V_{IN} = 0V$
C_{OUT}	6	8	pF	$V_{OUT} = 0V$

Note: 1. Typical values for nominal supply voltage. This parameter is only sampled and is not 100% tested.

Power-up Reset

The registers in the ATF22V10Bs are designed to reset during power-up. At a point delayed slightly from V_{CC} crossing V_{RST} , all registers will be reset to the low state. The output state will depend on the polarity of the output buffer.

This feature is critical for state machine initialization. However, due to the asynchronous nature of reset and the uncertainty of how V_{CC} actually rises in the system, the following conditions are required:

1. The V_{CC} rise must be monotonic,
2. After reset occurs, all input and feedback setup times must be met before driving the clock pin high, and
3. The clock must remain stable during t_{PR} .

Preload of Registered Outputs

The ATF22V10B's registers are provided with circuitry to allow loading of each register with either a high or a low. This feature will simplify testing since any state can be forced into the registers to control test sequencing. A JEDEC file with preload is generated when a source file with vectors is compiled. Once downloaded, the JEDEC file preload sequence will be done automatically by most of the approved programmers after the programming.

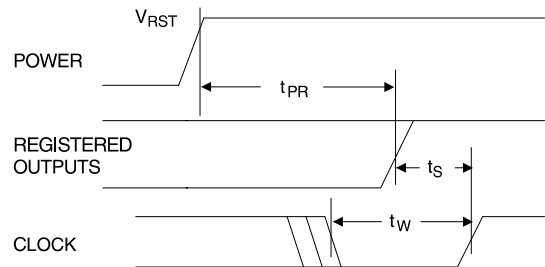

Parameter	Description	Typ	Max	Units
t_{PR}	Power-up Reset Time	600	1,000	ns
V_{RST}	Power-up Reset Voltage	3.8	4.5	V

Security Fuse Usage

A single fuse is provided to prevent unauthorized copying of the ATF22V10B fuse patterns. Once programmed, fuse verify and preload are inhibited. However, the 64-bit User Signature remains accessible.

The security fuse should be programmed last, as its effect is immediate.

Electronic Signature Word

There are 64 bits of programmable memory that are always available to the user, even if the device is secured. These bits can be used for user-specific data.

Programming/Erasing

Programming/erasing is performed using standard PLD programmers. See *CMOS PLD Programming Hardware and Software Support* for information on software/programming.

Input Diagram

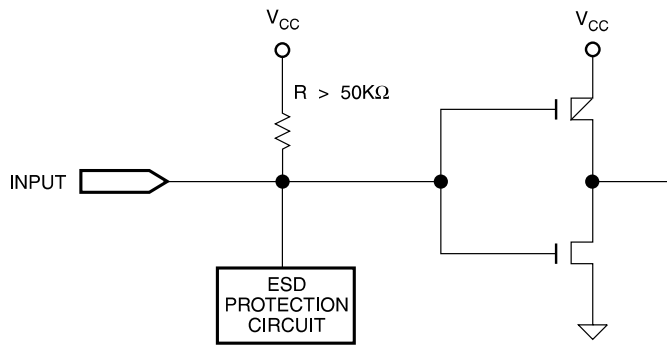

Input and I/O Pull-ups

All ATF22V10B family members have internal input and I/O pull-up resistors. Therefore, whenever inputs or I/Os are not being driven externally, they will float to V_{CC} . This ensures that all logic array inputs are at known states. These are relatively weak active pull-ups that can easily be overdriven by TTL-compatible drivers (see input and I/O diagrams below).

I/O Diagram

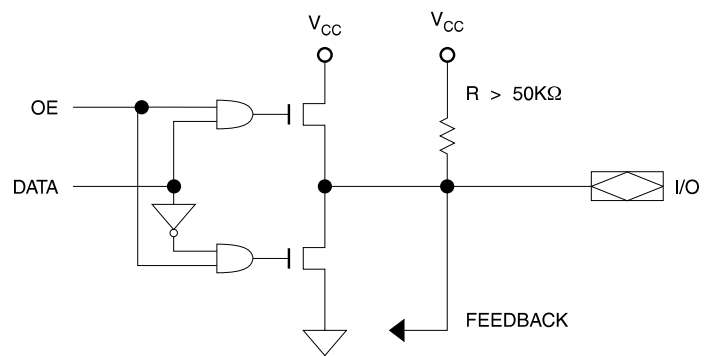

Functional Logic Diagram ATF22V10B

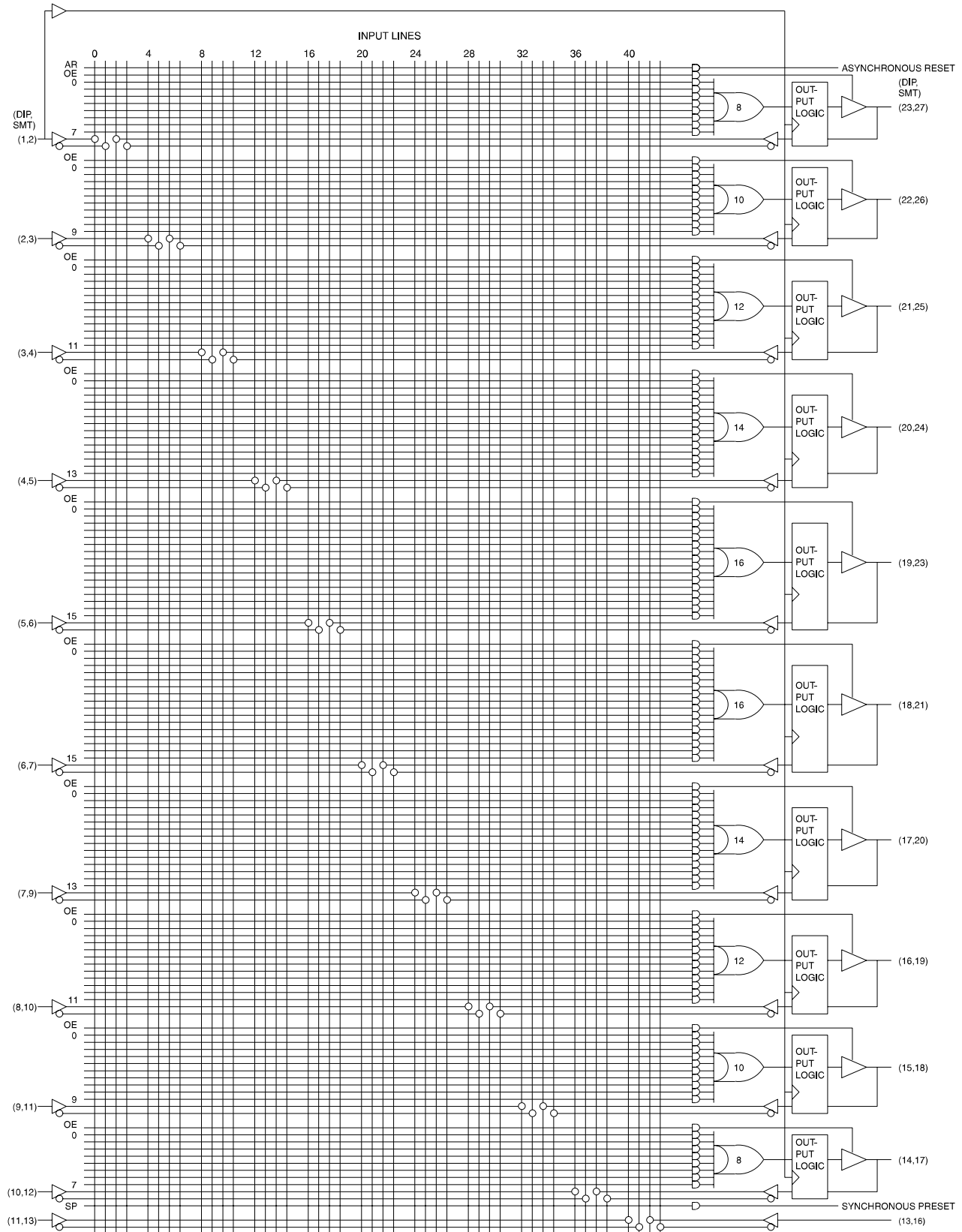

SUPPLY CURRENT vs. INPUT FREQUENCY
ATF22V10B/BQ (VCC = 5V, TA = 25°C)

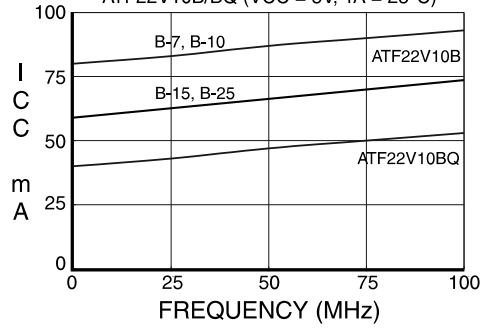

SUPPLY CURRENT vs. INPUT FREQUENCY
ATF22V10BL/BQL (VCC = 5V, TA = 25°C)

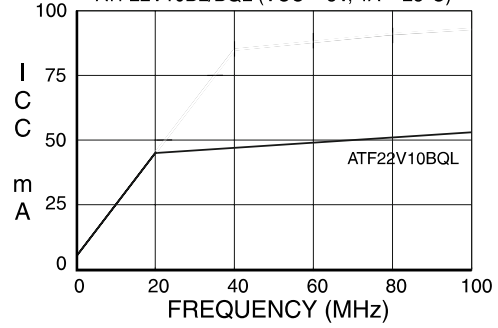

SUPPLY CURRENT vs. SUPPLY VOLTAGE
ATF22V10B/BQ (TA = 25°C)

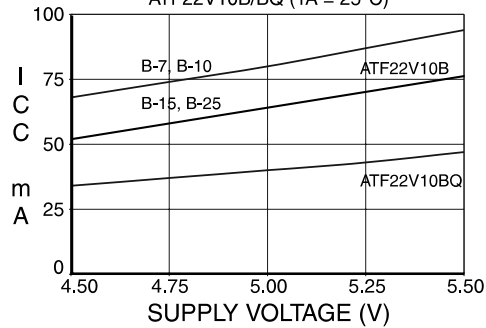

SUPPLY CURRENT vs. SUPPLY VOLTAGE
ATF22V10BL/BQL (TA = 25°C)

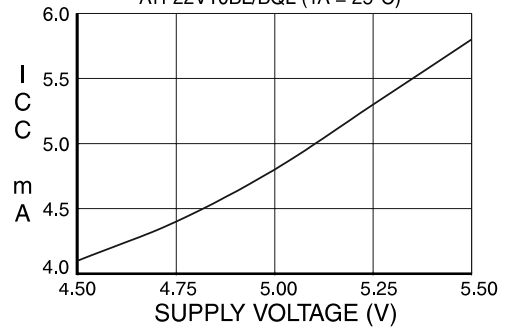

SUPPLY CURRENT vs. AMBIENT TEMPERATURE
ATF22V10B/BQ (VCC = 5V)

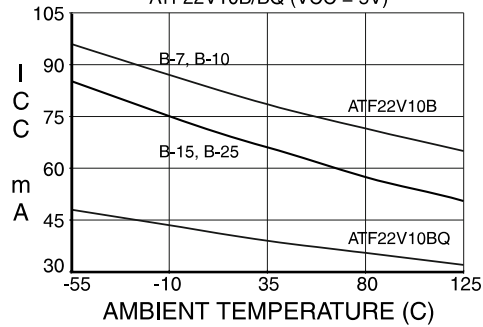

SUPPLY CURRENT vs. AMBIENT TEMPERATURE
ATF22V10BL/BQL (VCC = 5V)

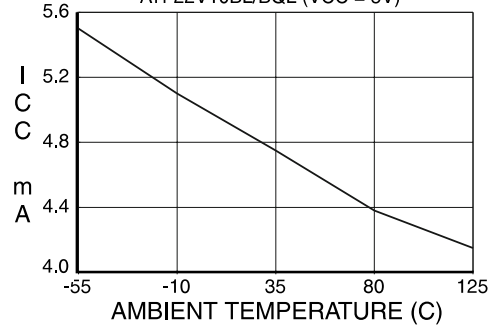

OUTPUT SOURCE CURRENT
vs. SUPPLY VOLTAGE (VOH = 2.4V)

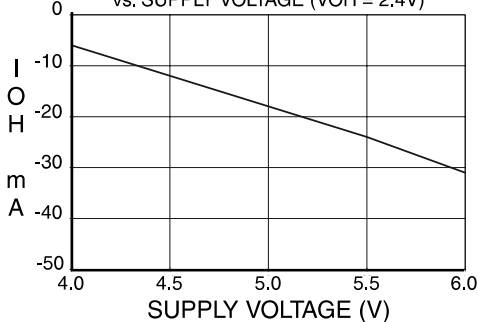

OUTPUT SINK CURRENT
vs. SUPPLY VOLTAGE (VOL = 0.5V)

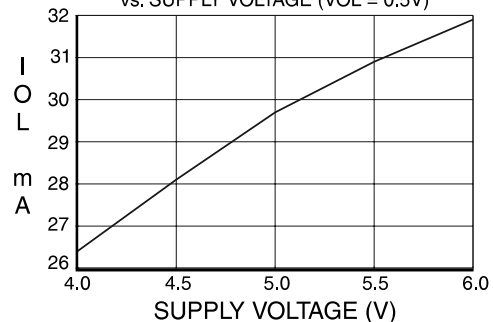

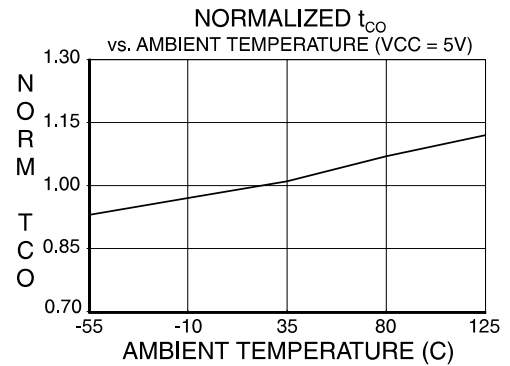
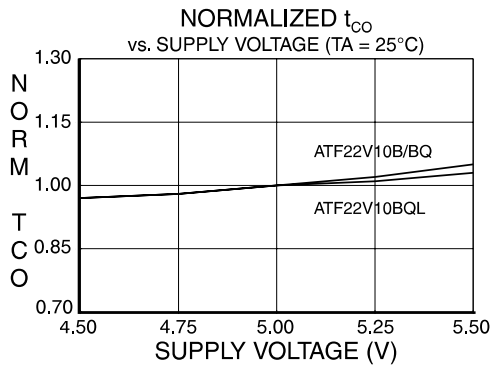
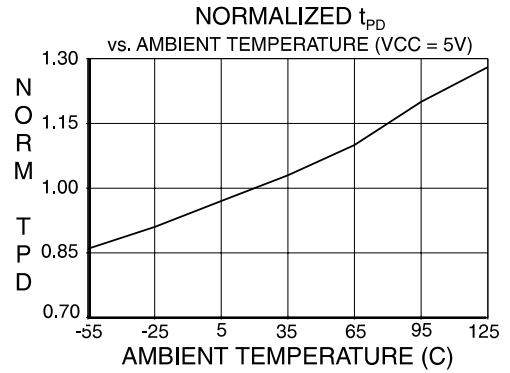
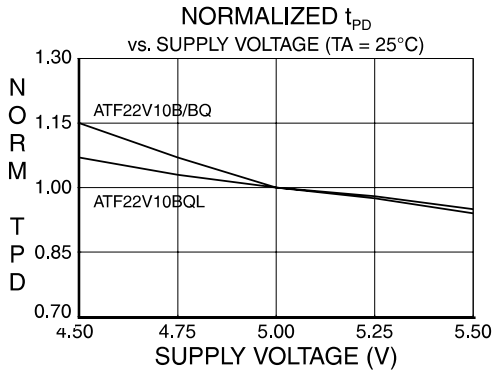
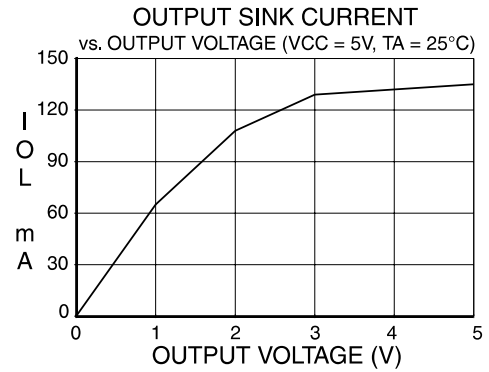
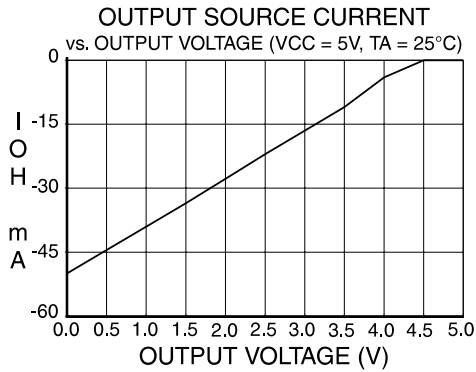
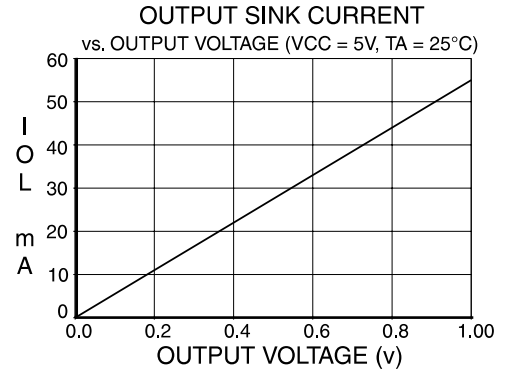
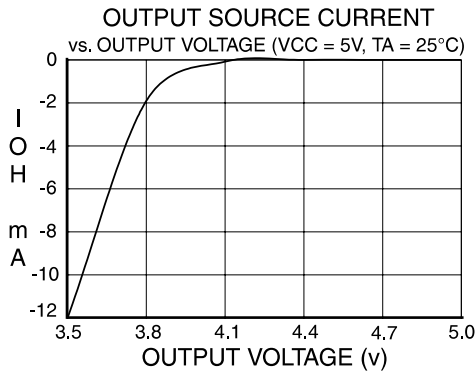

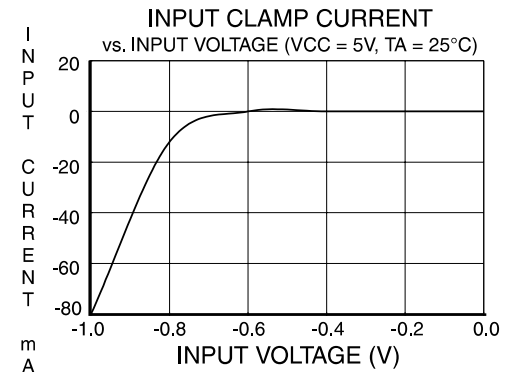
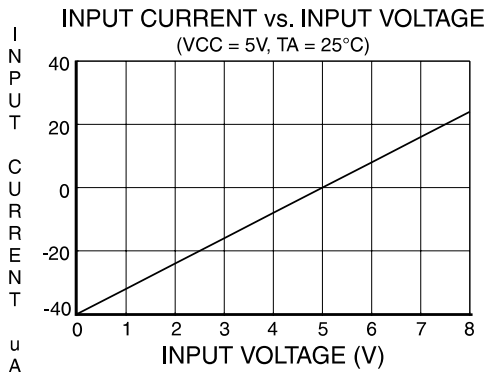
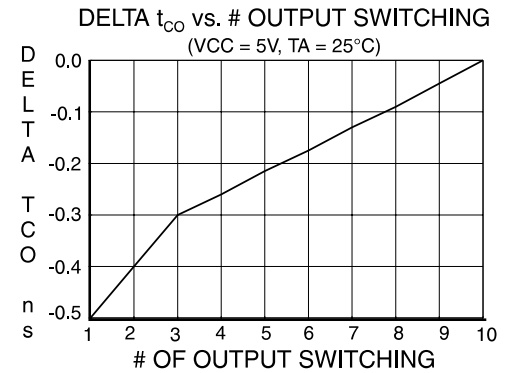
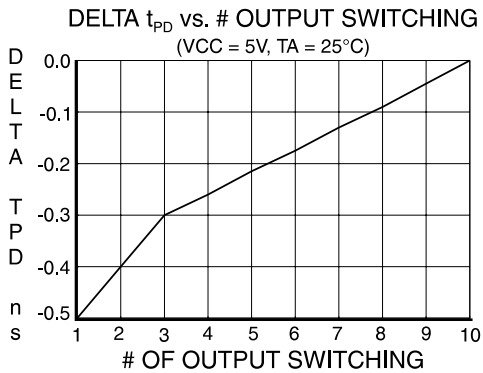
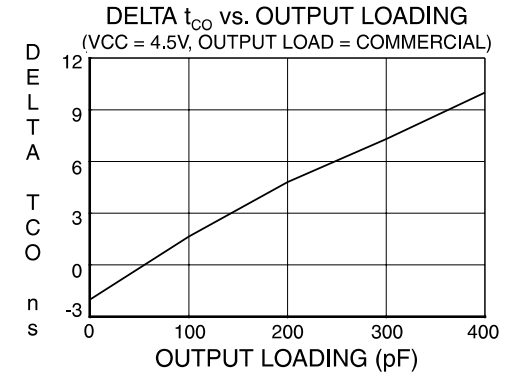
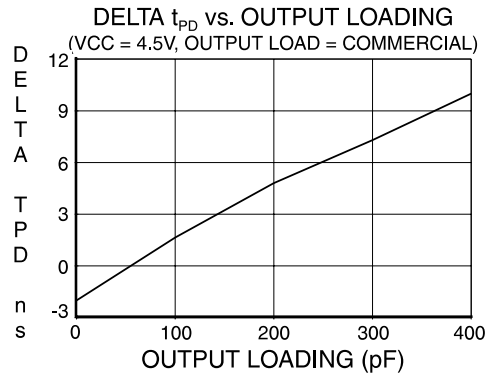
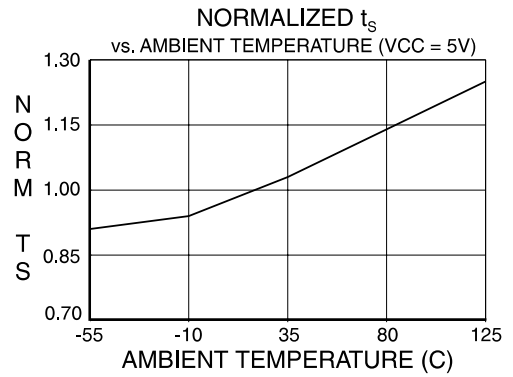
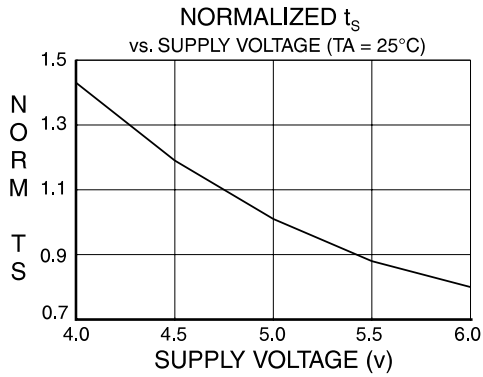

ATF22V10B Ordering Information

t_{PD} (ns)	t_S (ns)	t_{CO} (ns)	Ordering Code	Package	Operation Range
7.5	3.5	4.5	ATF22V10B-7JC ⁽¹⁾	28J	Commercial (0°C to 70°C)
			ATF22V10B-7PC ⁽¹⁾	24P3	
			ATF22V10B-7SC ⁽¹⁾	24S	
			ATF22V10B-7XC ⁽¹⁾	24X	
10	4.5	6.5	ATF22V10B-10JC ⁽¹⁾	28J	Commercial (0°C to 70°C)
			ATF22V10B-10PC ⁽¹⁾	24P3	
			ATF22V10B-10SC ⁽¹⁾	24S	
			ATF22V10B-10XC ⁽¹⁾	24X	
			ATF22V10B-10JI ⁽¹⁾	28J	Industrial (-40°C to 85°C)
			ATF22V10B-10PI ⁽¹⁾	24P3	
			ATF22V10B-10SI ⁽¹⁾	24S	
			ATF22V10B-10XI ⁽¹⁾	24X	
			ATF22V10B-10GM/883	24D3	Military/883C (-55°C to 125°C) Class B, Fully Compliant
			ATF22V10B-10NM/883	28L	
			5962-89841 06LA	24D3	Military (-55°C to 125°C) Class B, Fully Compliant
			5962-89841 063X	28L	
15	10	8	ATF22V10B-15JC ⁽¹⁾	28J	Commercial (0°C to 70°C)
			ATF22V10B-15PC ⁽¹⁾	24P3	
			ATF22V10B-15SC ⁽¹⁾	24S	
			ATF22V10B-15XC ⁽¹⁾	24X	
			ATF22V10B-15JI ⁽¹⁾	28J	Industrial (-40°C to 85°C)
			ATF22V10B-15PI ⁽¹⁾	24P3	
			ATF22V10B-15SI ⁽¹⁾	24S	
			ATF22V10B-15XI ⁽¹⁾	24X	
			ATF22V10B-15GM/883	24D3	Military/883C (-55°C to 125°C) Class B, Fully Compliant
			ATF22V10B-15NM/883	28L	
			5962-89841 03LA	24D3	Military (-55°C to 125°C) Class B, Fully Compliant
			5962-89841 033X	28L	
25	15	15	ATF22V10B-25JC	28J	Commercial (0°C to 70°C)
			ATF22V10B-25PC	24P3	
			ATF22V10B-25SC	24S	
			ATF22V10B-25XC	24X	
			ATF22V10B-25JI	28J	Industrial (-40°C to 85°C)
			ATF22V10B-25PI	24P3	
			ATF22V10B-25SI	24S	
			ATF22V10B-25XI	24X	

Notes: 1. Recommend ATF22V10C versions.
2. The shaded devices are obsolete.

ATF22V10BQ(L) Ordering Information

t_{PD} (ns)	t_S (ns)	t_{CO} (ns)	Ordering Code	Package	Operation Range
15	10	8	ATF22V10BQ-15JC ⁽¹⁾	28J	Commercial (0°C to 70°C)
			ATF22V10BQ-15PC ⁽¹⁾	24P3	
			ATF22V10BQ-15SC ⁽¹⁾	24S	
			ATF22V10BQ-15XC ⁽¹⁾	24X	
20	14	12	ATF22V10BQL-20JC ⁽¹⁾	28J	Commercial (0°C to 70°C)
			ATF22V10BQL-20PC ⁽¹⁾	24P3	
			ATF22V10BQL-20SC ⁽¹⁾	24S	
			ATF22V10BQL-20XC ⁽¹⁾	24X	
			ATF22V10BQL-20JI ⁽¹⁾	28J	Industrial (-40°C to 85°C)
			ATF22V10BQL-20PI ⁽¹⁾	24P3	
			ATF22V10BQL-20SI ⁽¹⁾	24S	
			ATF22V10BQL-20XI ⁽¹⁾	24X	
			ATF22V10BQL-20GM/883	24D3	Military/883C (-55°C to 125°C) Class B, Fully Compliant
			ATF22V10BQL-20NM/883	28L	
			5962-89841 14 LA	24D3	Military (-55°C to 125°C) Class B, Fully Compliant
			5962-89841 14 3X	28L	
25	15	15	ATF22V10BQL-25JC	28J	Commercial (0°C to 70°C)
			ATF22V10BQL-25PC	24P3	
			ATF22V10BQL-25SC	24S	
			ATF22V10BQL-25XC	24X	
			ATF22V10BQL-25JI	28J	Industrial (-40°C to 85°C)
			ATF22V10BQL-25PI	24P3	
			ATF22V10BQL-25SI	24S	
			ATF22V10BQL-25XI	24X	
			ATF22V10BQL-25GM/883	24D3	Military/883C (-55°C to 125°C) Class B, Fully Compliant
			ATF22V10BQL-25NM/883	28L	
			5962-89841 13 LA	24D3	Military (-55°C to 125°C) Class B, Fully Compliant
			5962-89841 13 3X	28L	

- Notes: 1. Recommend ATF22V10CQ and ATF2240CQZ
2. The shaded devices are obsolete.

Using “C” Product for Industrial

To use commercial product for Industrial temperature ranges, down-grade one speed grade from the “I” to the “C” device (7 ns “C” = 10 ns “I”) and de-rate power by 30%.

Package Type	
24D3	24-pin, 0.300" Wide, Ceramic Dual Inline Package (Cerdip)
28J	28-lead, Plastic J-leaded Chip Carrier (PLCC)
28L	28-pad, Ceramic Leadless Chip Carrier (LCC)
24P3	24-pin, 0.300" Wide, Plastic Dual Inline Package (PDIP)
24S	24-lead, 0.300" Wide, Plastic Gull Wing Small Outline (SOIC)
24X	24-lead, 4.4 mm Wide, Plastic Thin Shrink Small Outline (TSSOP)

Packaging Information

24D3, 24-pin, 0.300" Wide, Non-windowed, Ceramic Dual Inline Package (Cerdip)
 Dimensions in Inches and (Millimeters)
 MIL-STD-1835 D-9 CONFIG A

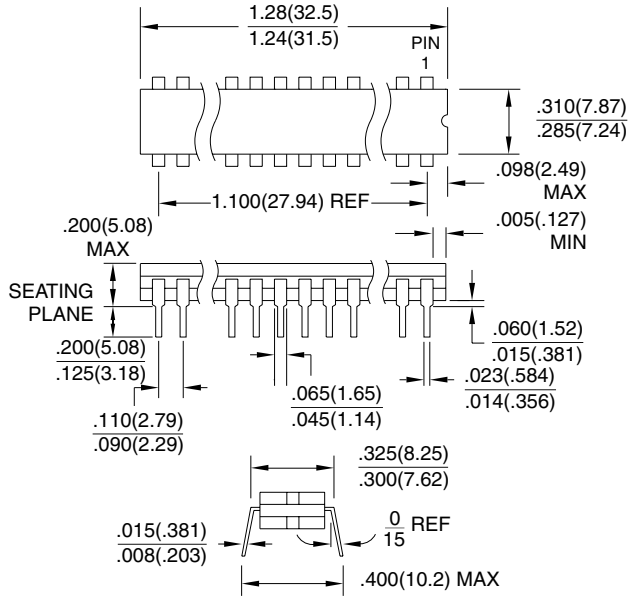

28J, 28-lead, Plastic J-leaded Chip Carrier (PLCC)
 Dimensions in Inches and (Millimeters)
 JEDEC STANDARD MS-018 AB

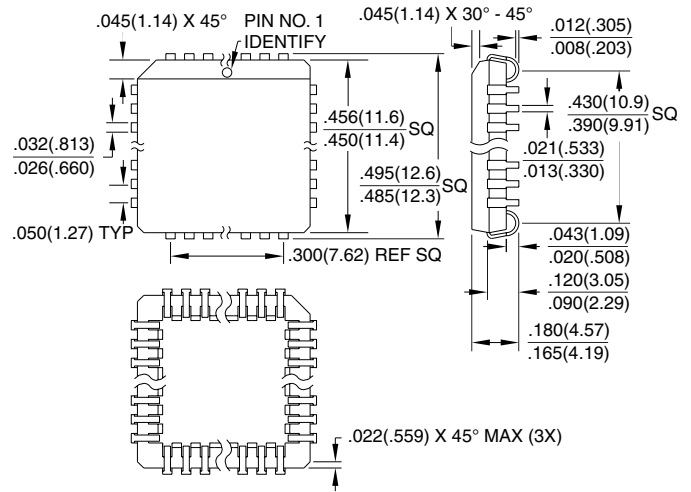

28L, 28-pad, Non-windowed, Ceramic Leadless Chip Carrier (LCC)
 Dimensions in Inches and (Millimeters)
 MIL-STD-1835 C-4

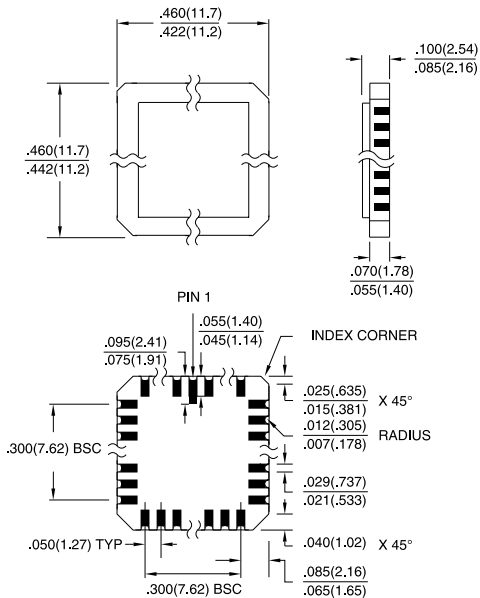

24P3, 24-pin, 0.300" Wide, Plastic Dual Inline Package (PDIP)
 Dimensions in Inches and (Millimeters)
 JEDEC STANDARD MS-001 AF

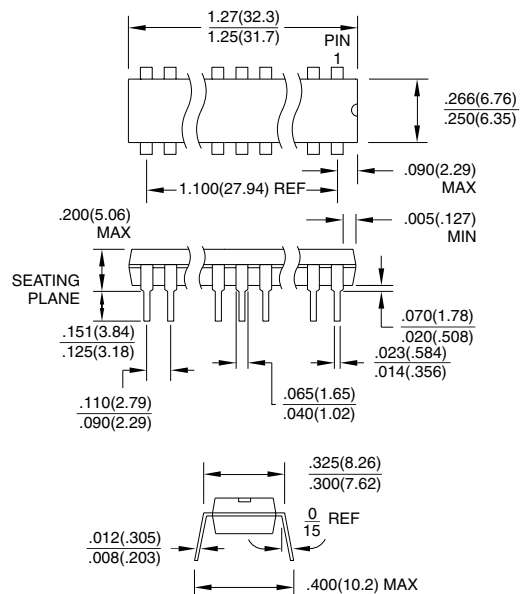

Packaging Information

24S, 24-lead, 0.300" Wide, Plastic Gull Wing Small Outline (SOIC)
 Dimensions in Inches and (Millimeters)

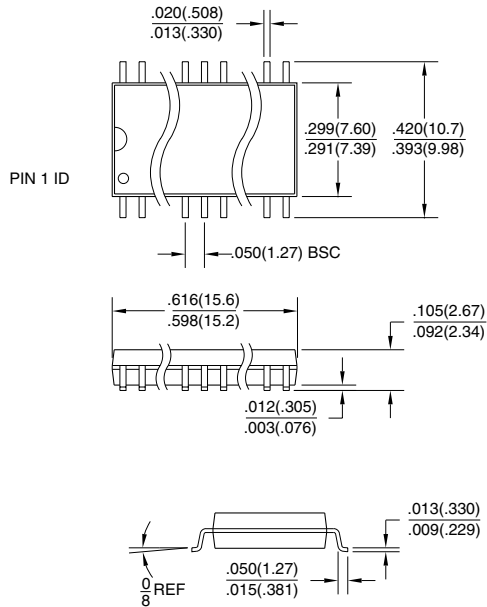

24X, 24-lead, 4.4 mm Wide, Plastic Thin Shrink Small Outline (TSSOP)
 Dimensions in Millimeters and (Inches)

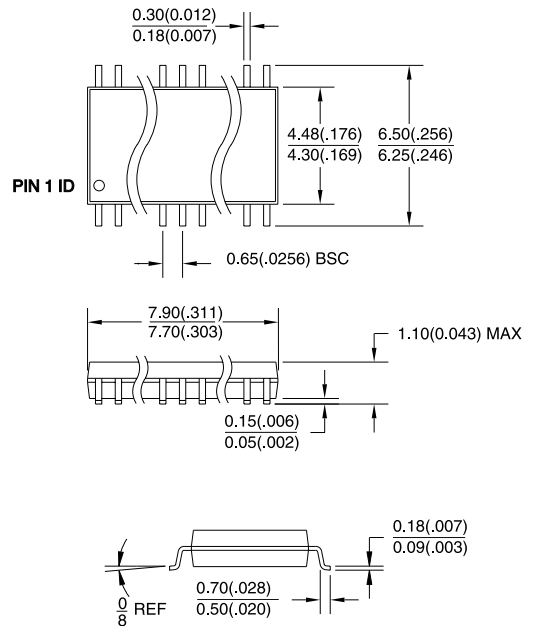



Atmel Headquarters

Corporate Headquarters

2325 Orchard Parkway
San Jose, CA 95131
TEL (408) 441-0311
FAX (408) 487-2600

Europe

Atmel SarL
Route des Arsenaux 41
Casa Postale 80
CH-1705 Fribourg
Switzerland
TEL (41) 26-426-5555
FAX (41) 26-426-5500

Asia

Atmel Asia, Ltd.
Room 1219
Chinachem Golden Plaza
77 Mody Road Tsimhatsui
East Kowloon
Hong Kong
TEL (852) 2721-9778
FAX (852) 2722-1369

Japan

Atmel Japan K.K.
9F, Tonetsu Shinkawa Bldg.
1-24-8 Shinkawa
Chuo-ku, Tokyo 104-0033
Japan
TEL (81) 3-3523-3551
FAX (81) 3-3523-7581

Atmel Operations

Atmel Colorado Springs

1150 E. Cheyenne Mtn. Blvd.
Colorado Springs, CO 80906
TEL (719) 576-3300
FAX (719) 540-1759

Atmel Rousset

Zone Industrielle
13106 Rousset Cedex
France
TEL (33) 4-4253-6000
FAX (33) 4-4253-6001

Atmel Smart Card ICs

Scottish Enterprise Technology Park
East Kilbride, Scotland G75 0QR
TEL (44) 1355-357-000
FAX (44) 1355-242-743

Atmel Grenoble

Avenue de Rochepleine
BP 123
38521 Saint-Egreve Cedex
France
TEL (33) 4-7658-3000
FAX (33) 4-7658-3480

Fax-on-Demand

North America:
1-(800) 292-8635

International:
1-(408) 441-0732

e-mail

literature@atmel.com

Web Site

<http://www.atmel.com>

BBS

1-(408) 436-4309

© Atmel Corporation 2001.

Atmel Corporation makes no warranty for the use of its products, other than those expressly contained in the Company's standard warranty which is detailed in Atmel's Terms and Conditions located on the Company's web site. The Company assumes no responsibility for any errors which may appear in this document, reserves the right to change devices or specifications detailed herein at any time without notice, and does not make any commitment to update the information contained herein. No licenses to patents or other intellectual property of Atmel are granted by the Company in connection with the sale of Atmel products, expressly or by implication. Atmel's products are not authorized for use as critical components in life support devices or systems.

Marks bearing ® and/or ™ are registered trademarks and trademarks of Atmel Corporation.

Terms and product names in this document may be trademarks of others.



Printed on recycled paper.

0250K-03/01/xM