

General Description

The MIC4426/4427/4428 family are highly-reliable dual low-side MOSFET drivers fabricated on a BiCMOS/DMOS process for low power consumption and high efficiency. These drivers translate TTL or CMOS input logic levels to output voltage levels that swing within 25mV of the positive supply or ground. Comparable bipolar devices are capable of swinging only to within 1V of the supply. The MIC4426/7/8 is available in three configurations: dual inverting, dual noninverting, and one inverting plus one noninverting output.

The MIC4426/4427/4428 are pin-compatible replacements for the MIC426/427/428 and MIC1426/1427/1428 with improved electrical performance and rugged design (Refer to the Device Replacement lists on the following page). They can withstand up to 500mA of reverse current (either polarity) without latching and up to 5V noise spikes (either polarity) on ground pins.

Primarily intended for driving power MOSFETs, MIC4426/7/8 drivers are suitable for driving other loads (capacitive, resistive, or inductive) which require low-impedance, high peak current, and fast switching time. Other applications include driving heavily loaded clock lines, coaxial cables, or piezoelectric transducers. The only load limitation is that total driver power dissipation must not exceed the limits of the package.

Features

- Bipolar/CMOS/DMOS construction
- Latch-up protection to >500mA reverse current
- 1.5A-peak output current
- 4.5V to 18V operating range
- Low quiescent supply current
4mA at logic 1 input
400µA at logic 0 input
- Switches 1000pF in 25ns
- Matched rise and fall times
- 7Ω output impedance
- < 40ns typical delay
- Logic-input threshold independent of supply voltage
- Logic-input protection to -5V
- 6pF typical equivalent input capacitance
- 25mV max. output offset from supply or ground
- Replaces MIC426/427/428 and MIC1426/1427/1428
- Dual inverting, dual noninverting, and inverting/noninverting configurations
- ESD protection

Applications

- MOSFET driver
- Clock line driver
- Coax cable driver
- Piezoelectric transducer driver

Functional Diagram

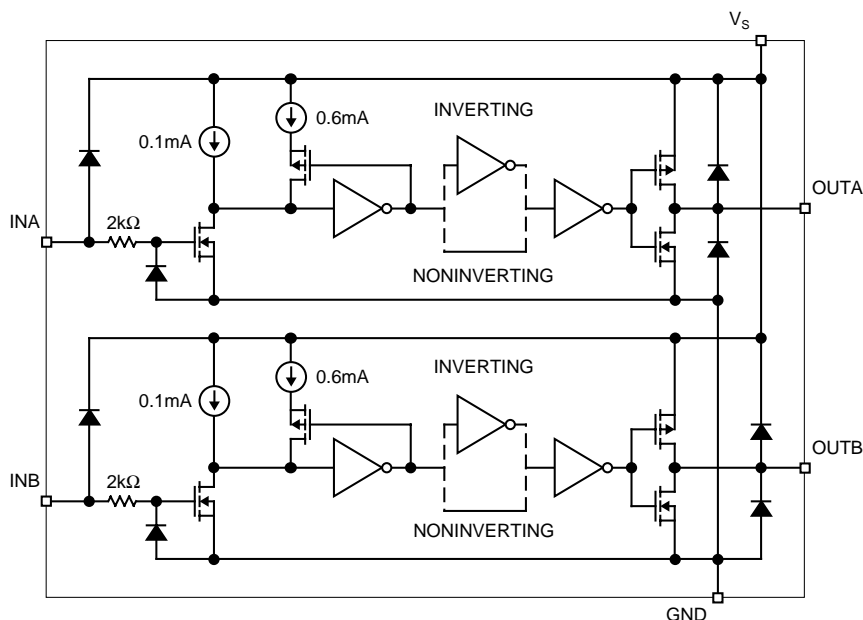

Ordering Information

Part Number	Temperature Range	Package	Configuration
MIC4426AM	-55°C to +125°C	8-lead SOIC	Dual Inverting
MIC4426BM	-40°C to +85°C	8-lead SOIC	Dual Inverting
MIC4426BMM	-40°C to +85°C	8-lead MSOP	Dual Inverting
MIC4426BN	-40°C to +85°C	8-lead Plastic DIP	Dual Inverting
MIC4427AM	-55°C to +125°C	8-lead SOIC	Dual Noninverting
MIC4427BM	-40°C to +85°C	8-lead SOIC	Dual Noninverting
MIC4427BMM	-40°C to +85°C	8-lead MSOP	Dual Noninverting
MIC4427BN	-40°C to +85°C	8-pin Plastic DIP	Dual Noninverting
MIC4428AM	-55°C to +125°C	8-lead SOIC	Inverting + Noninverting
MIC4428BM	-40°C to +85°C	8-lead SOIC	Inverting + Noninverting
MIC4428BMM	-40°C to +85°C	8-lead MSOP	Inverting + Noninverting
MIC4428BN	-40°C to +85°C	8-lead Plastic DIP	Inverting + Noninverting

MIC426/427/428 Device Replacement

Discontinued Number	Replacement
MIC426CM	MIC4426BM
MIC426BM	MIC4426BM
MIC426CN	MIC4426BN
MIC426BN	MIC4426BN
MIC427CM	MIC4427BM
MIC427BM	MIC4427BM
MIC427CN	MIC4427BN
MIC427BN	MIC4427BN
MIC428CM	MIC4428BM
MIC428BM	MIC4428BM
MIC428CN	MIC4428BN
MIC428BN	MIC4428BN

MIC1426/1427/1428 Device Replacement

Discontinued Number	Replacement
MIC1426CM	MIC4426BM
MIC1426BM	MIC4426BM
MIC1426CN	MIC4426BN
MIC1426BN	MIC4426BN
MIC1427CM	MIC4427BM
MIC1427BM	MIC4427BM
MIC1427CN	MIC4427BN
MIC1427BN	MIC4427BN
MIC1428CM	MIC4428BM
MIC1428BM	MIC4428BM
MIC1428CN	MIC4428BN
MIC1428BN	MIC4428BN

Pin Configuration

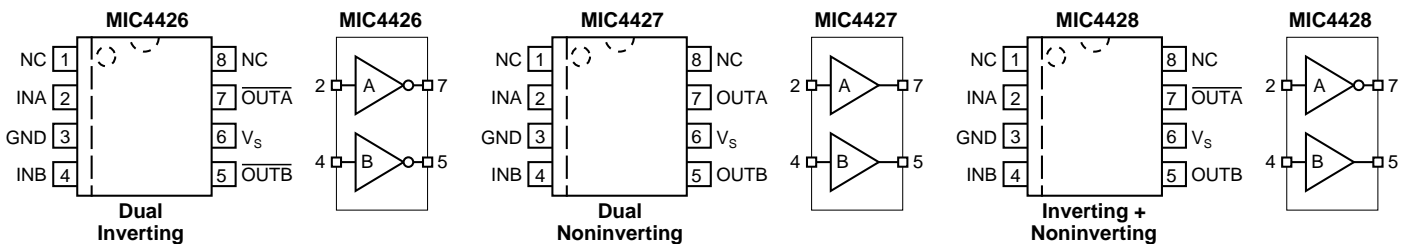

Pin Description

Pin Number	Pin Name	Pin Function
1, 8	NC	not internally connected
2	INA	Control Input A: TTL/CMOS compatible logic input.
3	GND	Ground
4	INB	Control Input B: TTL/CMOS compatible logic input.
5	OUTB	Output B: CMOS totem-pole output.
6	V _S	Supply Input: +4.5V to +18V
7	OUTA	Output A: CMOS totem-pole output.

Absolute Maximum Ratings (Note 1)

Supply Voltage (V_S)	+22V
Input Voltage (V_{IN})	$V_S + 0.3V$ to GND – 5V
Junction Temperature (T_J)	150°C
Storage Temperature	–65°C to +150°C
Lead Temperature (10 sec.)	300°C
ESD Rating, Note 3	

Operating Ratings (Note 2)

Supply Voltage (V_S)	+4.5V to +18V
Temperature Range (T_A)	(A) –55°C to +125°C (B) –40°C to +85°C
Package Thermal Resistance	
PDIP θ_{JA}	130°C/W
PDIP θ_{JC}	42°C/W
SOIC θ_{JA}	120°C/W
SOIC θ_{JC}	75°C/W
MSOP θ_{JC}	250°C/W

Electrical Characteristics

4.5V $\leq V_S \leq$ 18V; $T_A = 25^\circ\text{C}$, **bold** values indicate full specified temperature range; unless noted.

Symbol	Parameter	Condition	Min	Typ	Max	Units
Input						
V_{IH}	Logic 1 Input Voltage		2.4 2.4	1.4 1.5		V V
V_{IL}	Logic 0 Input Voltage			1.1 1.0	0.8 0.8	V V
I_{IN}	Input Current	$0 \leq V_{IN} \leq V_S$	–1		1	μA
Output						
V_{OH}	High Output Voltage		$V_S - 0.025$			V
V_{OL}	Low Output Voltage				0.025	V
R_O	Output Resistance	$I_{OUT} = 10\text{mA}$, $V_S = 18\text{V}$		6 8	10 12	Ω Ω
I_{PK}	Peak Output Current			1.5		A
I	Latch-Up Protection	withstand reverse current	>500			mA
Switching Time						
t_R	Rise Time	test Figure 1		18 20	30 40	ns ns
t_F	Fall Time	test Figure 1		15 29	20 40	ns ns
t_{D1}	Delay Time	test Figure 1		17 19	30 40	ns ns
t_{D2}	Delay Time	test Figure 1		23 27	50 60	ns ns
t_{PW}	Pulse Width	test Figure 1	400			ns
Power Supply						
I_S	Power Supply Current	$V_{INA} = V_{INB} = 3.0\text{V}$		1.4 1.5	4.5 8	mA mA
I_S	Power Supply Current	$V_{INA} = V_{INB} = 0.0\text{V}$		0.18 0.19	0.4 0.6	mA mA

Note 1. Exceeding the absolute maximum rating may damage the device.

Note 2. The device is not guaranteed to function outside its operating rating.

Note 3. Devices are ESD sensitive. Handling precautions recommended.

Test Circuits

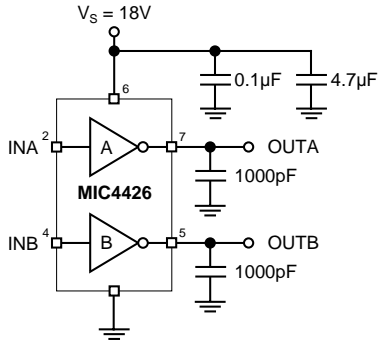

Figure 1a. Inverting Configuration

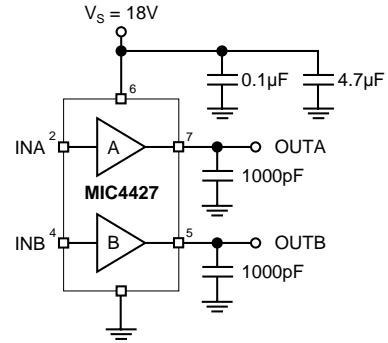

Figure 2a. Noninverting Configuration

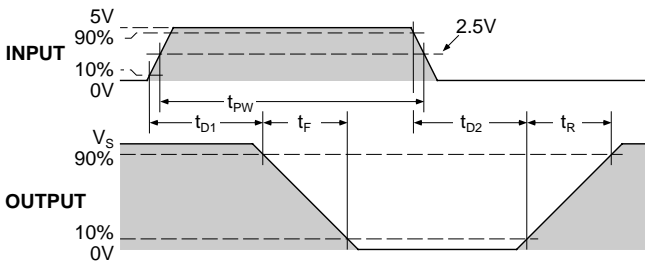

Figure 1b. Inverting Timing

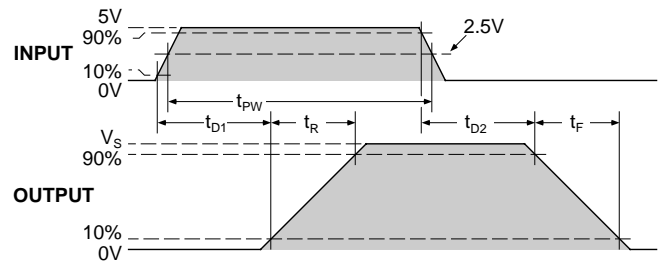
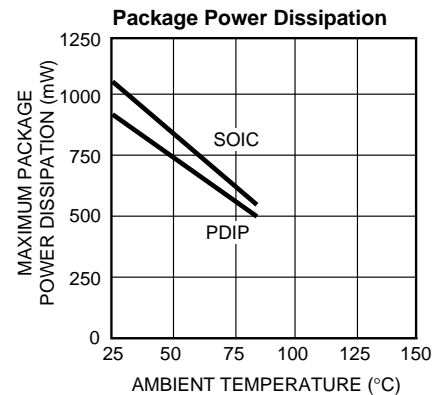
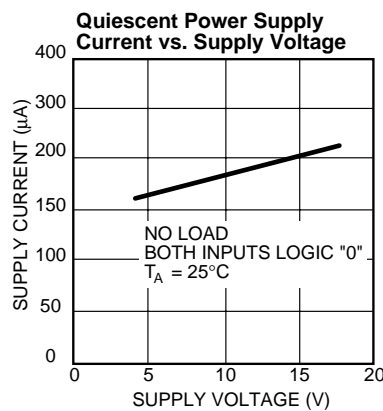
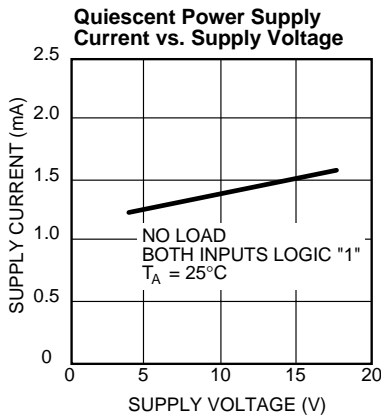
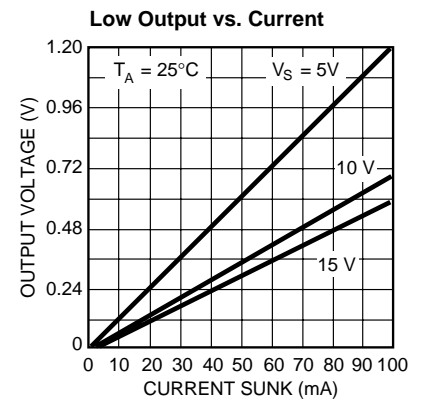
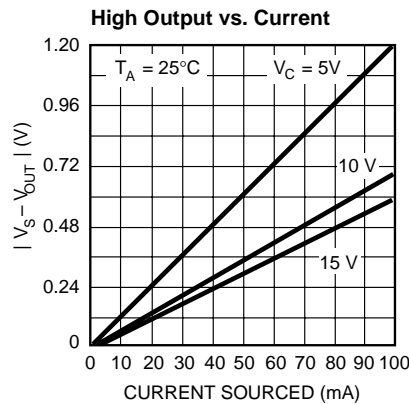
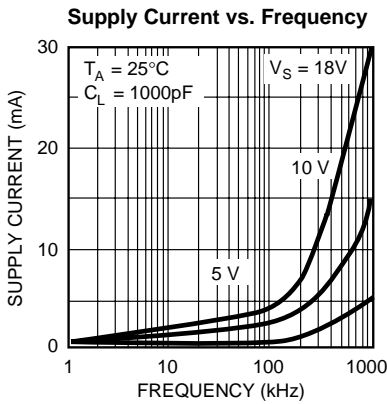
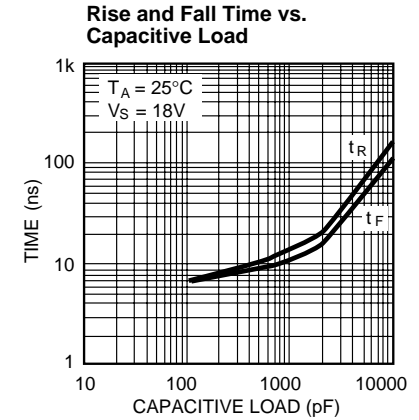
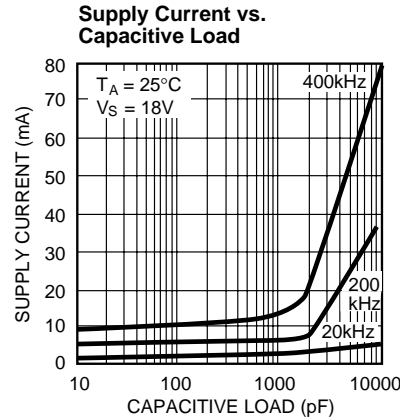
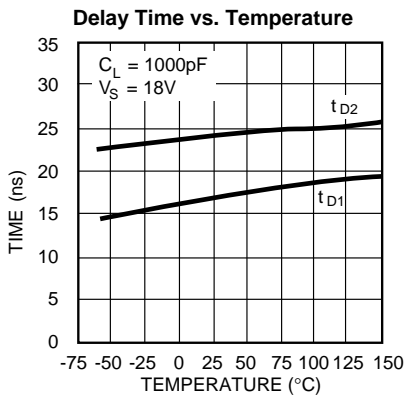
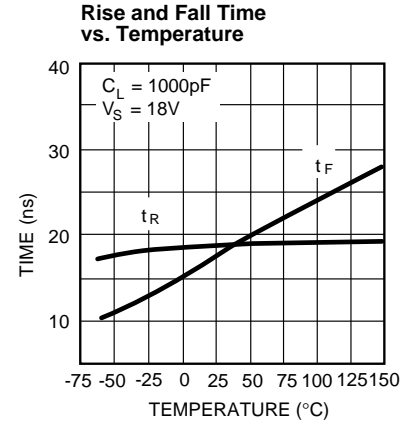
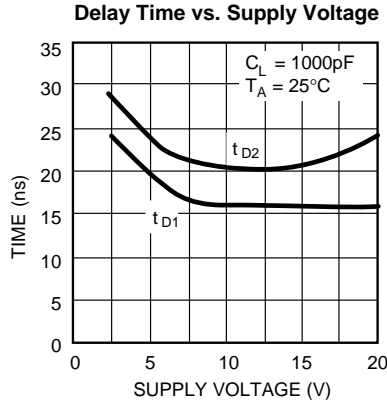
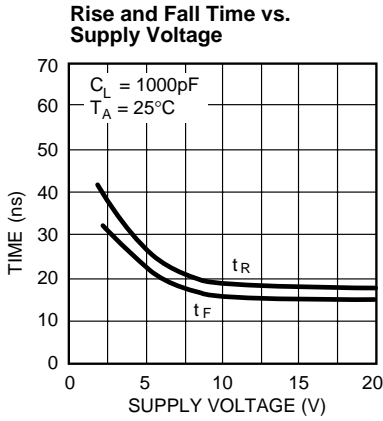

Figure 2b. Noninverting Timing

Electrical Characteristics



Applications Information

Supply Bypassing

Large currents are required to charge and discharge large capacitive loads quickly. For example, changing a 1000pF load by 16V in 25ns requires 0.8A from the supply input.

To guarantee low supply impedance over a wide frequency range, parallel capacitors are recommended for power supply bypassing. Low-inductance ceramic MLC capacitors with short lead lengths (< 0.5") should be used. A 1.0μF film capacitor in parallel with one or two 0.1μF ceramic MLC capacitors normally provides adequate bypassing.

Grounding

When using the inverting drivers in the MIC4426 or MIC4428, individual ground returns for the input and output circuits or a ground plane are recommended for optimum switching speed. The voltage drop that occurs between the driver's ground and the input signal ground, during normal high-current switching, will behave as negative feedback and degrade switching speed.

Control Input

Unused driver inputs must be connected to logic high (which can be V_S) or ground. For the lowest quiescent current (< 500μA), connect unused inputs to ground. A logic-high signal will cause the driver to draw up to 9mA.

The drivers are designed with 100mV of control input hysteresis. This provides clean transitions and minimizes output stage current spikes when changing states. The control input voltage threshold is approximately 1.5V. The control input recognizes 1.5V up to V_S as a logic high and draws less than 1μA within this range.

The MIC4426/7/8 drives the TL494, SG1526/7, MIC38C42, TSC170 and similar switch-mode power supply integrated circuits.

Power Dissipation

Power dissipation should be calculated to make sure that the driver is not operated beyond its thermal ratings. Quiescent power dissipation is negligible. A practical value for total power dissipation is the sum of the dissipation caused by the load and the transition power dissipation ($P_L + P_T$).

Load Dissipation

Power dissipation caused by continuous load current (when driving a resistive load) through the driver's output resistance is:

$$P_L = I_L^2 R_O$$

For capacitive loads, the dissipation in the driver is:

$$P_L = f C_L V_S^2$$

Transition Dissipation

In applications switching at a high frequency, transition power dissipation can be significant. This occurs during switching transitions when the P-channel and N-channel output FETs are both conducting for the brief moment when one is turning on and the other is turning off.

$$P_T = 2 f V_S Q$$

Charge (Q) is read from the following graph:

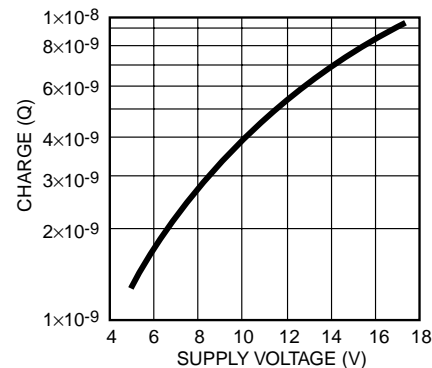

Crossover Energy Loss per Transition

Package Information

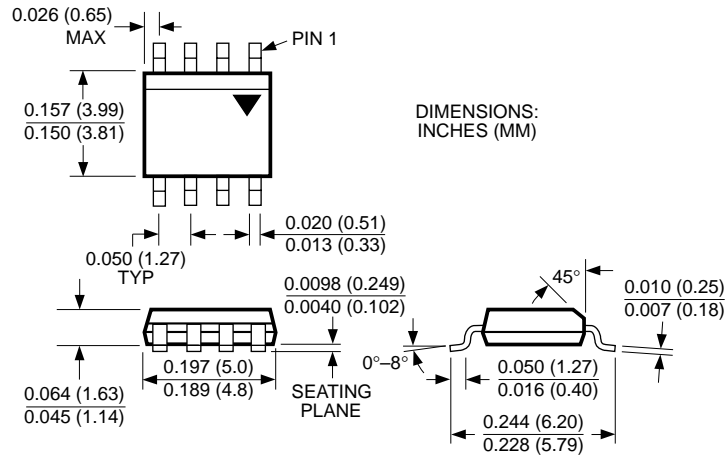

8-lead SOP (M)

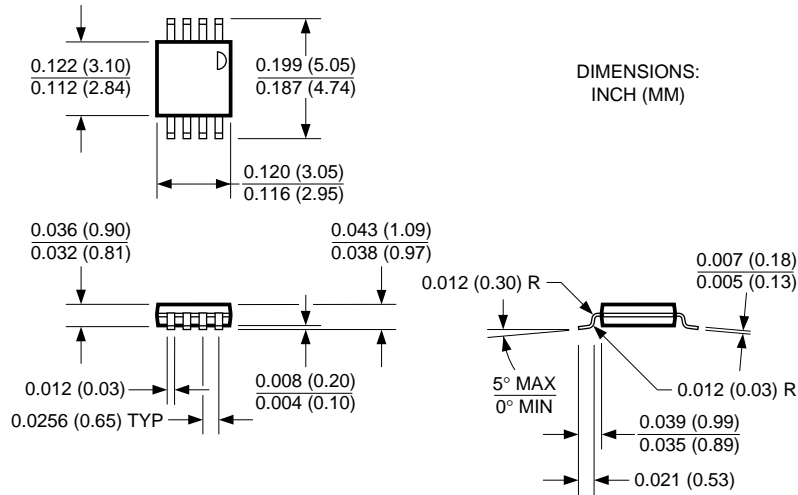

8-lead MM8™ MSOP (MM)

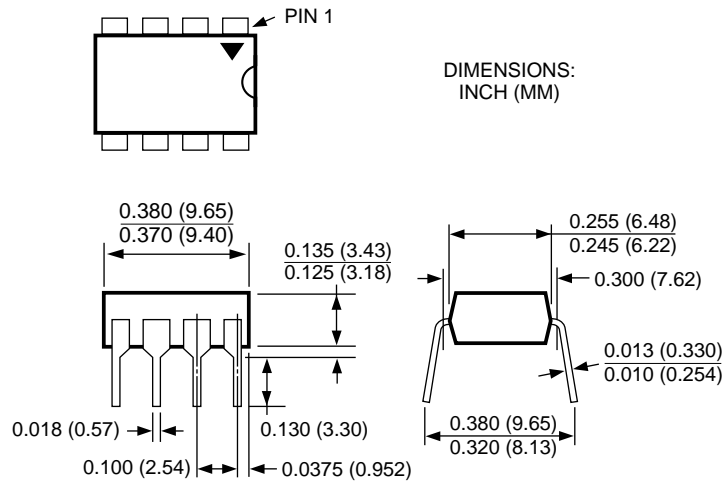

8-lead Plastic DIP (N)

MICREL INC. 1849 FORTUNE DRIVE SAN JOSE, CA 95131 USA

TEL + 1 (408) 944-0800 FAX + 1 (408) 944-0970 WEB <http://www.micrel.com>

This information is believed to be accurate and reliable, however no responsibility is assumed by Micrel for its use nor for any infringement of patents or other rights of third parties resulting from its use. No license is granted by implication or otherwise under any patent or patent right of Micrel Inc.

© 1999 Micrel Incorporated